

L · A · H

SUPPLIES LTD

For all your workshop consumable needs



Welcome...

To our latest publication - Now even bigger and better than ever!

Inside you will find our most comprehensive range yet with over 8,000 Part No.'s, featuring 100's of new lines, helping to provide you with the ultimate selection of quality workshop consumables and tools trusted and used by all trade professionals



Assorted Boxes	1 - 26	
Electrical Assembly	27 - 68	
Light + Power	69 - 112	
Threaded Fasteners	113 - 138	
Hardware + Trim Clips	139 - 184	
Trim Clips by OEM Ref	185 - 200	
Tubing + Air Line	201 - 236	
Auto, Commercial + Plant	237 - 286	
Grease + Chemicals	287 - 318	
Sealants + Adhesives	319 - 336	
Hygiene + Safety	337 - 388	
Welding, Gas + Abrasives	389 - 414	
Cutting + Drilling	415 - 432	
General Hand Tools	433 - 466	
Specialist Tools	467 - 482	
Storage + Security	483 - 495	
Essentials	496 - 504	
Product + Part No. Index	505 - 542	

Quality Brands You Can Depend On

Our expanding range of quality consumables and tools consists of market leading industrial brands you can trust, confidently rely and depend on each and every time

JAMEC PEM

CETIKER



osborn

je Speedfit

PCL

3M

Decosol



POP Avdel

ADVANCE

DELTA PLUS

KSTOOLS GERMANY

PRESSOL

alpen drill better.

DORMER

LEDLENSER

PROCELL PROFESSIONAL BATTERIES

ambersil

DURACELL

Littelfuse

REMA TROP

BAHCO

ECLIPSE PROFESSIONAL TOOLS

LOCTITE

RING

BAILCAST

FUCHS

MOLDEX

SAS

BARTON STORAGE SYSTEMS LIMITED

GP Batteries

MORSE THE M. K. MORSE COMPANY

sif

bibielle Abrasive Technologies

Granville

MOTIP

SSI SCHAEFER

BIG WIPES

Grippaz Patented Non-Slip Gloves

NEOLUX GERMAN TECHNOLOGY

TENGOOLS

BONDHUS

HellermannTyton

NORGREN

TERRY

Checkpoint

HYLOMAR

NORMA

VIP GERMAN TECHNOLOGY

deb SKIN CARE

JB WELD

NWS

VISION



2



5

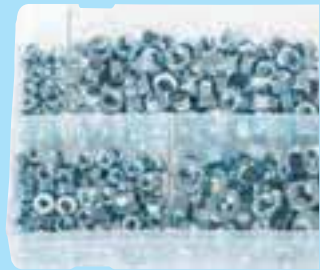

6



8



9



11



Assortments



12



13



14

- 2 Set Screws
- 4 Socket Screws
- 4 Grub Screws
- 5 Machine Screws
- 6 Nuts
- 8 Washers
- 10 Sealing Washers
- 11 O-Rings
- 12 Self-Tapping Screws
- 13 Number Plate Fasteners
- 14 Sheet Metal Screws
- 14 Speed Nuts
- 15 Rivets
- 15 Trim Clips
- 16 Pins
- 17 Clips
- 18 Springs
- 18 Woodruff Keys
- 19 Tube Couplings
- 19 Olives
- 19 Hose Clips
- 20 Brakes
- 20 Exhausts
- 21 Core Plugs
- 21 Grease Nipples
- 22 Terminals
- 24 Cable Accessories
- 25 Fuses
- 26 Empty Boxes + Storage System



15



16



18

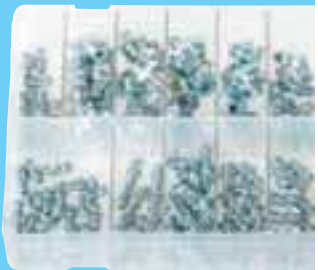

21



22



25



26





Set Screws

**BEST
SELLER**



Set Screws High Tensile - Metric

Zinc plated steel. DIN 933 Grade 8.8.

Part No.	Box of
AB99	150 Pieces

1 x M5: x 25 mm. 1 x M6: x 25 mm. 2 x M8: x 25, 40 mm.
2 x M10: x 25, 40 mm.



Set Screws High Tensile - Metric

Zinc plated steel. DIN 933 Grade 8.8.

Part No.	Box of
AB564	290 Pieces

2 x M4: x 10, 20 mm. 3 x M5: x 10, 16, 30 mm.
5 x M6: x 10, 12, 16, 20, 30 mm. 4 x M8: x 16, 20, 30, 40 mm.
2 x M10: x 25, 30 mm. 3 x M12: x 20, 30, 40 mm.

M5



M6



**BEST
SELLER**

M5 Fasteners

Zinc plated steel.
DIN 933 Grade 8.8 (Set Screws High Tensile).
DIN 934 (Steel Nuts). DIN 125 (Flat Washers).

Part No.	Box of
AB163N	550 Pieces

5 x Set Screws: M5 x 16, 20, 25, 40, 50 mm.
1 x Steel Nuts: M5. 1 x Flat Washers: M5.



M6 Fasteners

Zinc plated steel.
DIN 933 Grade 8.8 (Set Screws High Tensile).
DIN 934 (Steel Nuts). DIN 125 (Flat Washers).

Part No.	Box of
AB128N	485 Pieces

5 x Set Screws: M6 x 16, 20, 25, 35, 50 mm.
1 x Steel Nuts: M6. 1 x Flat Washers: M6.



AB 'Flip Box'

Standard size transparent polypropylene box.
Complete with 8 dividers. Dimensions (W x H x D):
214 x 43 x 138 mm (8 3/8" x 1 3/4" x 5 3/8").

Part No.	Qty	Description
ABM	1	AB Flip Box

M8



**BEST
SELLER**

M10



M8 Fasteners

Zinc plated steel.
DIN 933 Grade 8.8 (Set Screws High Tensile).
DIN 934 (Steel Nuts). DIN 125 (Flat Washers).

Part No.	Box of
AB129N	245 Pieces

5 x Set Screws: M8 x 20, 25, 40, 50, 75 mm. 1 x Steel Nuts: M8.
1 x Flat Washers: M8.



M10 Fasteners

Zinc plated steel.
DIN 933 Grade 8.8 (Set Screws High Tensile).
DIN 934 (Steel Nuts). DIN 125 (Flat Washers).

Part No.	Box of
AB130N	150 Pieces

4 x Set Screws: M10 x 25, 40, 50, 75 mm. 1 x Steel Nuts: M10.
1 x Flat Washers: M10.



Stainless Steel Set Screws - Metric

Stainless Steel. DIN 933 Grade A2.

Part No.	Box of
AB154	120 Pieces

1 x M5: x 25 mm. 1 x M6: x 25 mm. 1 x M8: x 25 mm.
1 x M8: x 40 mm. 2 x M10: x 25, 40 mm.





Set Screws High Tensile - Metric Fine

Zinc plated steel.
DIN 961 Grade 8.8.

Part No. Box of

AB11N **140 Pieces**

1 x M5 (x 0.50 mm Pitch): x 25 mm.
1 x M6 (x 0.75 mm Pitch): x 25 mm.
2 x M8 (x 1.00 mm Pitch): x 25, 40 mm.
1 x M10 (x 1.25 mm Pitch): x 40 mm. 1 x M12 (x 1.50 mm Pitch) x 55 mm.

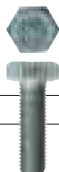

Set Screws High Tensile - UNC

Zinc plated steel.
ANSI B18.2.1.1965 Grade 8.8 Equivalent.

Part No. Box of

AB7N **150 Pieces**

2 x 1/4" UNC: x 3/4", x 1", 2 x 5/16" UNC: x 1", x 1 1/2".
2 x 3/8" UNC: x 1", x 1 1/2".



Set Screws High Tensile - UNF

Zinc plated steel.
ANSI B18.2.1.1965 Grade 8.8 Equivalent.

Part No. Box of

AB5N **150 Pieces**

1 x 3/16" UNF: x 1", 1 x 1/4" UNF: x 1".
2 x 5/16" UNF: x 1", x 1 1/2". 2 x 3/8" UNF: x 1", 1 1/2".



Storage Rack for AB 'Flip Box'

PVC coated wire. Dimensions (H x W x D):
460 x 300 x 210 mm. (Boxes shown NOT included).

- Holds up to 10 boxes for fast and easy retrieval.
- Can be free-standing or wall mounted.

Part No. Qty Description

ABR 1 Storage Rack



AB 'Max Box' Carrying Case

Made from cold rolled steel, finished in grey baked enamel.

- Holds up to 5 boxes (NOT included).
- Keyhole slots enable case to be wall-mounted.
- Bolt holes enable cases to be stacked.



Part No. Qty Description

SB101 1 Carrying Case



Looking for Spanners & Wrenches?

A comprehensive range of Spanners and Wrenches start from Page 452



Looking for Ratchets & Sockets?

Our full range of Ratchets and Sockets start from Page 455





Socket Screws Cap Head - Metric Black

Black. DIN 912 Grade 12.9.

Part No. Box of

AB92 100 Pieces

2 x M5: x 30, 40 mm. 2 x M6: x 30, 40 mm.
2 x M8: x 30, 40 mm. 2 x M10: x 30, 40 mm.



Socket Screws, Button Head - Metric Black

Black. Grade 10.9.

Part No. Box of

AB204N 115 Pieces

2 x M5: x 12, 16 mm. 4 x M6: x 12, 16, 25, 30 mm.
3 x M8: x 20, 25, 30 mm. 1 x M10: x 40 mm.



Grub Screws - Metric

Black. DIN 916.

Part No. Box of

AB17 250 Pieces

1 x M4: x 8 mm. 2 x M5: x 5, 10 mm. 3 x M6: x 6, 8, 10 mm.
3 x M8: x 8, 10, 12 mm. 1 x M10: x 10 mm.



Grub Screws - Metric

Black. Flat Point, Cone Point, Dog Point.

Part No. Box of

AB219 130 Pieces

3 x Flat Point: M5 x 10, M8 x 35, M8 x 40.
2 x Cone Point: M6 x 12, M8 x 12. 2 x Dog Point: M8 x 16, M10 x 25.

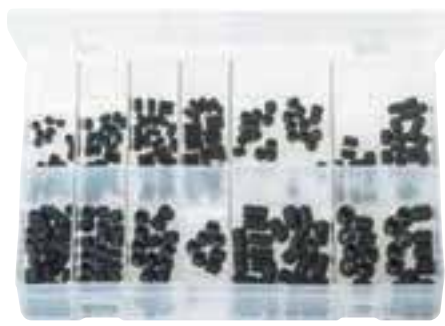

Grub Screws - UNC/BSW

Black. DIN 916.

Part No. Box of

AB18 275 Pieces

4 x 3/16" UNC/BSW: x 3/16", 1/4", 5/16", 3/8".
3 x 1/4" UNC/BSW: x 1/4", 5/16", 1/2".
3 x 5/16" UNC/BSW: x 1/4, 5/16", 1/2". 1 x 3/8" UNC/BSW: x 3/8".



Grub Screws - UNF

Black. DIN 916.

Part No. Box of

AB16 225 Pieces

3 x 3/16" UNF: x 3/16", 1/4", 3/8". 3 x 1/4" UNF: x 1/4", 5/16", 7/16".
2 x 5/16" UNF: x 5/16, 3/8". 1 x 3/8" UNF: x 3/8".



Socket Screws Cap Head - Metric Black

Black. DIN 912 Grade 12.9.

Part No. Box of

AB562 270 Pieces

2 x M4: 12, 20 mm. 4 x M5: 16, 20, 30, 40 mm. 5 x M6: 12, 16, 20, 30, 40 mm. 4 x M8: 12, 20, 30, 40 mm.
2 x M10: 30, 40. 1 x M12: 50.



Socket Screws Cap Head - Metric

Zinc plated steel. DIN 912 Grade 12.9.

Part No. Box of

AB563 300 Pieces

2 x M3: x 8, 16 mm. 2 x M4: x 20, 30 mm. 6 x M5: x 10, 16, 25, 30, 35, 40 mm.
4 x M6: x 20, 25, 30, 35 mm. 4 x M8: x 16, 20, 30, 45 mm. 3 x M10: x 25, 30, 40 mm. 1 x M12: x 25 mm.

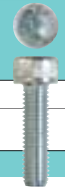



Machine Screws (Body Screws) Pan Head, Pozi - Metric

Zinc plated steel. DIN 7985.

Part No.	Box of
AB134N	290 Pieces

3 x M4: x 12, 35, 50 mm. 4 x M5: x 20, 25, 40, 50 mm.
2 x M6: x 20, 25 mm.



Machine Screws (Body Screws) Countersunk, Pozi - Metric

Zinc plated steel. DIN 965.

Part No.	Box of
AB135N	250 Pieces

2 x M5: x 20, 25 mm. 3 x M6: x 20, 25, 50 mm. 1 x M8: x 20 mm.



Machine Screws Cheese Head, Slotted - Metric

Zinc plated steel. DIN 84 Grade 4.8.

Part No.	Box of
AB209N	435 Pieces

8 x M3: x 6, 8, 10, 12, 20, 25, 30, 50 mm. 2 x M4: x 6, 12 mm.
1 x M5: x 8. 2 x M6: 10, 20 mm.



Machine Screws with Nuts, Round Head, Slotted - BA

Zinc plated steel. BS 57.

Part No.	Box of
AB3	1,025 Pieces

8 x Machine Screws: 6BA x 3/4", 6BA x 1", 4BA x 3/4", 4BA x 1", 4BA x 2", 2BA x 1, 2BA x 1 1/2", 2BA x 2". 3 x Nuts: 6BA, 4BA, 2BA.

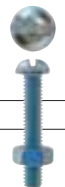

Machine Screws with Nuts, Round Head, Slotted - BA

Brass. BS 57.

Part No.	Box of
AB4N	410 Pieces

10 x Machine Screws: 6BA x 1/2", 6BA x 3/4", 6BA x 1", 4BA x 1/2", 4BA x 3/4", 4BA x 1", 2BA x 1/2", 2BA x 3/4", 2BA x 1", 2BA x 1 1/2".
3 x Nuts: 6BA, 4BA, 2BA.



BEST SELLER

Machine Screws with Nuts & Washers, Pan Head, Slotted - Metric

Zinc plated steel. DIN 85 & DIN 934.

Part No.	Box of
AB68N	840 Pieces

6 x Machine Screws: M3 x 8 mm, M3 x 20 mm, M4 x 20 mm, M4 x 40 mm, M5 x 25 mm, M5 x 50 mm.
3 x Nuts: M3, M4, M5. 3 x Washers: M3, M4, M5.

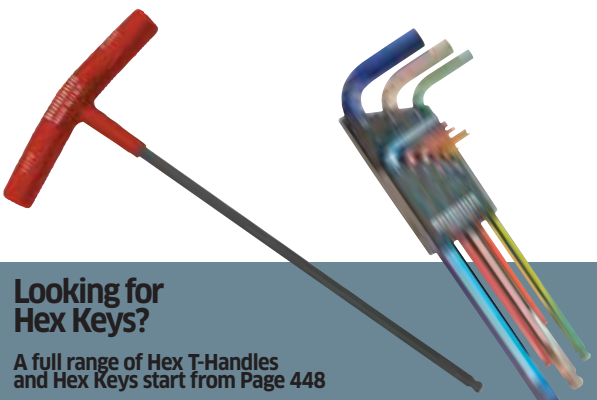

Looking for Hex Keys?

A full range of Hex T-Handles and Hex Keys start from Page 448



Looking for Screwdrivers & Bits?

Our full range of Screwdrivers and Bits start from Page 442





Nuts

**BEST
SELLER**



Steel Nuts - Metric (Popular Sizes)

Zinc plated steel.
DIN 934.

Part No. Box of
AB10N **370 Pieces**

5 x Sizes: M5, M6, M8, M10, M12.



Steel Nuts - Metric

Zinc plated steel.
DIN 934.

Part No. Box of
AB202N **275 Pieces**

8 x Sizes: M4, M5, M6, M8, M10, M12, M14, M16.



Steel Nuts - Metric Fine

Zinc plated steel.
DIN 934.

Part No. Box of
AB12N **350 Pieces**

7 x Sizes: M5 x 0.50 mm, M6 x 0.75 mm, M8 x 1.00 mm, M10 x 1.00 mm, M10 x 1.25 mm, M12 x 1.25 mm, M12 x 1.50 mm.



Stainless Steel Nuts - Metric

Stainless Steel.
DIN 934 Grade A2.

Part No. Box of
AB155 **250 Pieces**

4 x Sizes: M5, M6, M8, M10.

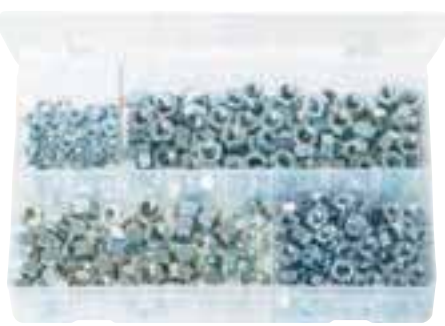

Steel Nuts - UNF

Zinc plated steel.
ANSI B18.2.2.

Part No. Box of
AB6N **325 Pieces**

4 x UNF: 3/16", 1/4", 5/16", 3/8".

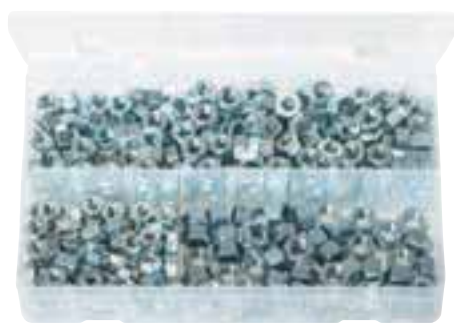

Steel Nuts - UNC

Zinc plated steel.
ANSI B18.2.2.

Part No. Box of
AB8N **350 Pieces**

3 x UNC: 1/4", 5/16", 3/8".

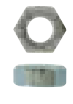

Serrated Flange Nuts - Metric

Zinc plated steel.
DIN 6923.

Part No. Box of
AB104N **330 Pieces**

5 x Sizes: M5, M6, M8, M10, M12.





Steel Nuts & Nylon Lock Nuts

Zinc plated steel.
DIN 934 (Steel Nuts)/DIN 982 (Nylon Lock Nuts, P-Type).

Part No. Box of
AB510 **400 Pieces**

5 x Sizes, Steel Nuts: M5, M6, M8, M10, M12.
7 x Sizes, Nylon Lock Nuts: M5, M6, M7, M8, M10, M12, M14.





BEST SELLER

Nylon Lock Nuts - Metric (Popular Sizes)

Zinc plated steel. P-Type. DIN 982.



Part No.	Box of
AB15N	300 Pieces

4 x Sizes: M6, M8, M10, M12.



Nylon Lock Nuts - Metric

Zinc plated steel. P-Type. DIN 982.



Part No.	Box of
AB201N	275 Pieces

8 x Sizes: M4, M5, M6, M8, M10, M12, M14, M16.



Stainless Steel Nylon Lock Nuts - Metric

Stainless Steel. T-Type. DIN 985 Grade A2.



Part No.	Box of
AB156N	225 Pieces

4 x Sizes: M5, M6, M8, M10.

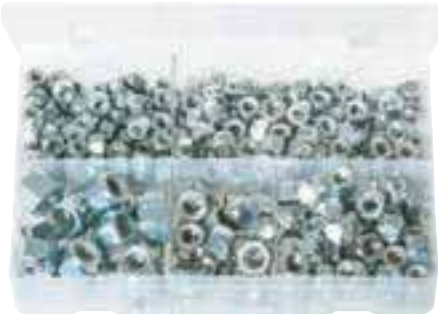

Nylon Lock Nuts - UNF

Zinc plated steel. BS 4929 Equivalent.



Part No.	Box of
AB13N	290 Pieces

5 x UNF: 1/4", 5/16", 3/8", 7/16", 1/2".



Threaded Inserts - Regular

Zinc plated steel.



Part No.	Box of
AB78N	250 Pieces

5 x Sizes: M4, M5, M6, M8, M10.



Threaded Inserts - Half Hex

Zinc plated steel.



Part No.	Box of
AB182	225 Pieces

4 x Sizes: M4, M5, M6, M8.



Nylon Lock Nuts - UNC

Zinc plated steel. BS 4929 Equivalent.



Part No.	Box of
AB14N	275 Pieces

4 x UNC: 1/4", 5/16", 3/8", 1/2".



Threaded Inserts - Cylindrical Head Full Hex

Zinc plated steel. Large flange.



Part No.	Box of
AB181	250 Pieces

5 x Sizes: M4, M5, M6, M8, M10.



Threaded Inserts - Splined

Zinc plated steel.



Part No.	Box of
AB183	225 Pieces

4 x Sizes: M4, M5, M6, M8.





BEST SELLER



Flat Washers 'Form A' - Metric

Zinc plated steel.
DIN 125 Type A. Heavy Gauge.

Part No. Box of

AB76N **800 Pieces**

9 x Sizes: M3, M4, M5, M6, M8, M10, M12, M16, M20.



Flat Washers 'Table 3' - Imperial

Zinc plated steel.
BS 3410 Table 3 (Heavy Gauge).

Part No. Box of

AB20N **800 Pieces**

6 x Sizes: 3/16", 1/4", 5/16", 3/8", 7/16", 1/2".



Stainless Steel Flat Washers - Metric

Stainless Steel. BS 4320 [Table 1] Form B Grade A2.
*DIN 125A (BS 4320 [Table 1] Form A) Grade A2.

Part No. Box of

AB157 **650 Pieces**

4 x Sizes: M5*, M6, M8, M10.



BEST SELLER



Flat Washers 'Form C' - Metric

Zinc plated steel.
BS 4320 Form C.

Part No. Box of

AB119N **620 Pieces**

6 x Sizes: M6, M8, M10, M12, M14, M16.

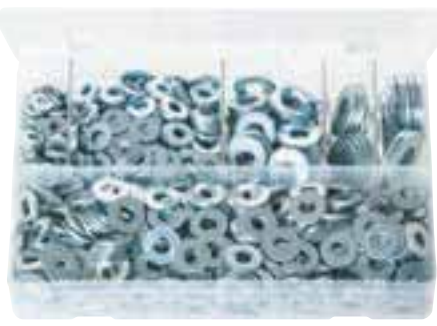

Flat Washers 'Table 4' - Imperial

Zinc plated steel.
BS 3410 Table 4 (Heavy Gauge).

Part No. Box of

AB109N **920 Pieces**

6 x Sizes: 3/16" x 1/2", 1/4" x 5/8", 5/16" x 3/4", 3/8" x 7/8", 1/2" x 1 1/8", 5/8" x 1 3/8".



Shim Washers

Zinc plated steel.

Part No. Box of

AB28N **315 Pieces**

8 x 0.010 Thick: 3/16" x 7/16", 1/4" x 9/16", 5/16" x 5/8", 3/8" x 3/4", 7/16" x 7/8", 1/2" x 1", 5/8" x 1 1/4", 3/4" x 1 1/2".
7 x 0.015 Thick: 1/4" x 9/16", 5/16" x 5/8", 3/8" x 3/4", 7/16" x 7/8", 1/2" x 1", 5/8" x 1 1/4", 3/4" x 1 1/2".



BEST SELLER



Lock Washers Serrated - Internal

Zinc plated steel.
DIN 6798.

Part No. Box of

AB27N **800 Pieces**

6 x Sizes: M5, M6, M8, M10, M11, M13.



Lock Washers Serrated - External

Zinc plated steel.

Part No. Box of

AB208N **440 Pieces**

8 x Sizes: M4, M5, M6, M8, M10, M12, M14, M16.

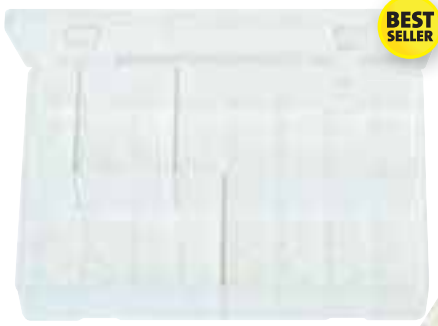

AB 'Flip Box'

Standard size transparent polypropylene box.
Complete with 8 dividers. Dimensions (W x H x D):
214 x 43 x 138 mm (8 3/8" x 1 3/4" x 5 3/8").

Part No. Qty Description

ABM 1 **AB Flip Box**



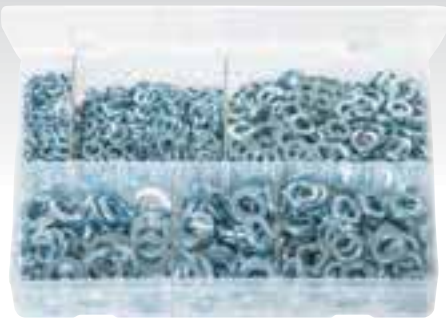

Spring Washers - Imperial

Zinc plated steel.
Rectangular Section ANSI B18.21.1 Table 2.

Part No.	Box of
AB21N	800 Pieces

6 x Sizes: 3/16", 1/4", 5/16", 3/8", 7/16", 1/2".



Spring Washers - Metric

Zinc plated steel. Rectangular Section.
DIN 127B.

Part No.	Box of
AB77N	1,015 Pieces

8 x Sizes: M4, M5, M6, M8, M10, M12, M16, M20.



Stainless Steel Spring Washers - Metric

Stainless Steel. Square Section.
DIN 7980 Grade A2.

Part No.	Box of
AB158	650 Pieces

4 x Sizes: M5, M6, M8, M10.



BEST SELLER

Bonded Seals (Dowty Washers) - BSP

Metal with black nitrile rubber (NBR).
Self centralising.

Part No.	Box of
AB67N	100 Pieces

7 x Sizes: 1/8" BSP, 1/4" BSP, 3/8" BSP, 1/2" BSP, 5/8" BSP, 3/4" BSP, 1" BSP.



BEST SELLER

Bonded Seals (Dowty Washers) - Metric

Metal with black nitrile rubber (NBR).
Self centralising.

Part No.	Box of
AB107	90 Pieces

8 x Sizes: M10, M12, M14, M16, M18, M20, M22, M24.



BEST SELLER

Repair Washers - Imperial

Zinc plated steel.
1.37/1.69 mm thickness.

Part No.	Box of
AB22N	220 Pieces

6 x Sizes (L.D. x O.D.): 3/16" x 1", 1/4" x 1", 1/4" x 1 1/2", 5/16" x 1", 5/16" x 1 1/2", 3/8" x 1 1/2".



Fibre Washers - Metric

DIN 7603A.

Part No.	Box of
AB143	600 Pieces

8 x Sizes: M5 x 9 x 1.0, M6 x 10 x 1.0, M8 x 12 x 1.0, M10 x 14 x 1.0, M12 x 18 x 1.5, M14 x 20 x 1.5, M16 x 22 x 1.5, M18 x 24 x 1.5.



Fibre Washers - Imperial

WS 010.

Part No.	Box of
AB25N	600 Pieces

8 x Sizes: 13/64" x 3/8", 1/4" x 3/8", 5/16" x 5/8", 3/8" x 5/8", 29/64" x 11/16", 1/2" x 11/16", 5/8" x 7/8", 49/64" x 1".



Copper Washers - Imperial

WS 086.

Part No.	Box of
AB24N	400 Pieces

6 x Sizes: 3/16" x 7/16", 1/4" x 9/16", 5/16" x 5/8", 3/8" x 3/4", 7/16" x 7/8", 1/2" x 1" (M5, M6, M8, M10, M12).





BEST SELLER



Copper Sealing Washers - Metric

DIN 7603A.

Part No.	Box of
AB106	250 Pieces

16 x Sizes: M5 x 9 x 1.0, M6 x 10 x 1.0, M6 x 12 x 1.0, M8 x 12 x 1.0, M8 x 14 x 1.0, M10 x 14 x 1.0, M10 x 16 x 1.0, M12 x 16 x 1.5, M12 x 18 x 1.5, M14 x 18 x 1.5, M14 x 20 x 1.5, M16 x 20 x 1.5, M16 x 22 x 1.5, M18 x 22 x 1.5, M18 x 24 x 1.5, M20 x 26 x 1.5 mm.



Copper Sealing Washers - Metric

DIN 7603A.

Part No.	Box of
AB505	1,050 Pieces

16 Sizes: M5 x 9 x 1.0, M6 x 10 x 1.0, M6 x 12 x 1.0, M8 x 12 x 1.0, M8 x 14 x 1.0, M10 x 14 x 1.0, M10 x 16 x 1.0, M12 x 16 x 1.5, M12 x 18 x 1.5, M14 x 18 x 1.5, M14 x 20 x 1.5, M16 x 20 x 1.5, M16 x 22 x 1.5, M18 x 22 x 1.5, M18 x 24 x 1.5, M20 x 26 x 1.5 mm.



Copper Sealing Washers - Imperial/BSP

Part No.	Box of
AB23	225 Pieces

16 x Sizes: 1/4" (265 x .375 x 20g), 1/4" (265 x .437 x 20g), 1/4" (265 x .500 x 20g), 5/16" (.323 x .437 x 20g), 5/16" (.323 x .500 x 20g), 1/8" BSP (3/8") (.390 x .590 x 20g), 1/8" BSP (3/8") (.390 x .590 x 18g), 1/4" BSP (5/32") (.530 x .720 x 20g), 1/4" BSP (5/32") (.530 x .750 x 18g), 3/8" BSP (21/32") (.665 x .875 x 18g), 1/2" BSP (13/16") (.830 x 1.00 x 18g), 1/2" BSP (13/16") (.830 x 1.04 x 18g), 5/8" BSP (29/32") (.910 x 1.13 x 16g), 3/4" BSP (1.05 x 1.32 x 16g), 7/8" BSP (1.20 x 1.50 x 16g), 1" BSP (1.5/16") (1.32 x 1.62 x 16g).



Aluminium Washers - Metric

DIN 7603A.

Part No.	Box of
AB149	260 Pieces

11 x Sizes: M6 x 10, M8 x 11, M10 x 13, M10 x 14, M12 x 16, M12 x 18, M14 x 18, M14 x 20, M16 x 20, M17 x 21, M22 x 27.



Copper Washers - Imperial

WS 086.

Part No.	Box of
AB24N	400 Pieces

6 x Sizes: 3/16" x 7/16", 1/4" x 9/16", 5/16" x 5/8", 3/8" x 3/4", 7/16" x 7/8", 1/2" x 1" (M5, M6, M8, M10, M12).



Copper Sealing Washers (Diesel Injector Washers)

Copper. DIN 7603A.

Part No.	Box of
AB142	250 Pieces

16 x Sizes: M6 x 10 x 1.0 (BOSCH 2916 710 602), M8 x 11.5 x 1.0 (LUCAS NW5-17W4, BOSCH 2916 710 646), M10 x 13.5 x 1.0 (BOSCH 2916 710 605), M10 x 14 x 1.0 (BOSCH 2916 710 649), M10 x 20 x 1.0 (MAN/PERKINS P.2411126), M10 x 20 x 2.0 (BOSCH 5339401, PERKINS P.0920113), M12 x 16 x 1.5 (BOSCH 2916 710 607), M12 x 18 x 1.5 (BOSCH 2916 710 608), M14 x 18 x 1.5 (BOSCH 2916 710 609), M14 x 20 x 1.5 (BOSCH 2916 710 610), M16 x 20 x 1.5 (BOSCH 2916 710 611), M17 x 21 x 1.5 (BOSCH 2916 710 611, GM 14025557), M21 x 25 x 1.0 (LUCAS NW5/59), M22 x 27 x 1.0 (LUCAS NW5/60).



Sump Plug Washers

Part No.	Box of
AB17N	265 Pieces

4 x Copper Compression: 12 x 17 x 2.00, 14 x 20 x 2.0, 16 x 22 x 2.0, 18 x 24 x 2.0 mm.
4 x Flat Copper: 10 x 20 x 2.00, 12 x 17 x 1.5, 14 x 20 x 1.5, 14 x 20 x 2.0 mm.
2 x Aluminium: 14 x 22 x 2.0, 18 x 24 x 1.5 mm.
2 x Flanged Rubber O-ring: 11 x 21 x 2.5, 13 x 22 x 3.0 mm. 1 x Nitrile Rubber O-Ring: 18 x 2 NBR.
1 x Fibre: 12 x 24 x 2.0 mm. 1 x Bonded Seal: 16.7 x 24 mm.



AB 'Flip Box'

Standard size transparent polypropylene box. Complete with 8 dividers. Dimensions (W x H x D): 214 x 43 x 138 mm (8 3/8" x 1 3/4" x 5 3/8").

Part No.	Qty	Description
ABM	1	AB Flip Box

BEST SELLER



O-Rings - Metric

Nitrile rubber. BS 4518.

Part No. Box of

AB81 325 Pieces

4 x I.D. x Thickness: 4.1 x 1.6, 6.1 x 1.6, 10.1 x 1.6, 12.1 x 1.6.

4 x I.D. x Thickness: 7.6 x 2.4, 9.6 x 2.4, 11.6 x 2.4, 12.6 x 2.4

2 x I.D. x Thickness: 19.5 x 3.0, 24.5 x 3.0.



O-Rings - Imperial

Nitrile rubber. BS 1806.

Part No. Box of

AB61 325 Pieces

10 x ARP/BS: 008, 010, 011, 012, 013, 014, 016, 116, 118, 120.



O-Ring Splicing Kit

Nitrile rubber.

Part No. Description

AB126 14 Piece Kit

5 x Imperial Nitrile Rubber Cord, 1 m Lengths: 1/16", 3/32", 1/8", 3/16", 1/4".

6 x Metric Nitrile Rubber Cord, 1 m Lengths: 1.6, 2, 3, 4, 5, 5.7 mm.

1 x Trimming Knife. 1 x Cutting Block. 1 x S.A.S Super Glue: 5g.



O-Rings Service Kit - Metric

Nitrile rubber. BS 4518.

Part No. Box of

AB100 404 Pieces

30 x Sizes (Peg Ref) I.D. x Thickness:

3 x 2 (006), 4 x 2 (007), 5 x 2 (008), 6 x 2 (009), 7 x 2 (010), 8 x 2 (011),

10 x 2 (012), 10 x 2.5 (110), 11 x 2.5 (111), 12 x 2.5 (112), 14 x 2.5 (113),

16 x 2.5 (114), 17 x 2.5 (115), 19 x 2.5 (116), 19 x 3 (210), 20 x 3 (211),

22 x 3 (212), 24 x 3 (213), 25 x 3 (214), 27 x 3 (215), 28 x 3 (216),

30 x 3 (217), 32 x 3 (218), 33 x 3 (219), 35 x 3 (220), 36 x 3 (221),

38 x 3 (222), 38 x 4 (325), 41 x 4 (326), 44 x 4 mm (327).



O-Rings Service Kit - Imperial

Nitrile rubber. BS 1806.

Part No. Box of

AB101 382 Pieces

30 x Sizes (ARP/BS) I.D. x Thickness:

2.90 x 1.78 (006), 3.68 x 1.78 (007), 4.48 x 1.78 (008), 5.28 x 1.78 (009),

6.07 x 1.78 (010), 7.66 x 1.78 (011), 9.25 x 1.78 (012), 9.19 x 2.62 (110),

10.78 x 2.62 (111), 12.37 x 2.62 (112), 13.95 x 2.62 (113),

15.54 x 2.62 (114), 17.13 x 2.62 (115), 18.72 x 2.62 (116),

18.64 x 3.53 (210), 20.22 x 3.53 (211), 21.82 x 3.53 (212),

23.40 x 3.53 (213), 24.99 x 3.53 (214), 26.58 x 3.53 (215),

28.17 x 3.53 (216), 29.75 x 3.53 (217), 31.34 x 3.53 (218),

32.92 x 3.53 (219), 34.52 x 3.53 (220), 36.10 x 3.53 (221),

37.69 x 3.53 (222), 37.47 x 5.33 (325), 40.65 x 5.33 (326),

43.82 x 5.33 (327).



Air Conditioning O-Rings Kit

Highly saturated nitrile O-rings for use

with Freon R134a.

Supplied in a hinged plastic case.

Part No. Description

HAC200 270 Piece Kit

18 x Sizes (I.D. x Thickness):

5.29 x 1.78 (7/32" x 1/16"), (1/4" x 1/16"), 6.07 x 1.78,

6.8 x 1.9, 7.65 x 1.78 (5/16" x 1/16"), 7.8 x 1.9, 8 x 2, 8.8 x 1.9 (20 pcs).

10.82 x 1.78 (7/16" x 1/16"), 10.77 x 2.62 (7/16" x 3/32"),

11 x 2, 12 x 2 (15 pcs), 13.9 x 1.8, 13.95 x 2.62 (9/16" x 3/32"),

14 x 2, 15 x 2, 17 x 2, 17.17 x 1.78 (11/16" x 1/16"),

17.04 x 3.53 mm (11/16" x 1/8") (10 pcs).



O-Rings





Self-Drilling Screws Pan Head - Phillips

Zinc plated steel. DIN 7504N.

Part No.	Box of
AB137	500 Pieces

3 x No. 6: x 1/2", 3/4", 1". 3 x No. 8: x 1/2", 3/4", 1".
5 x No. 10: x 1/2", 3/4", 1", 1 1/2", x 2".

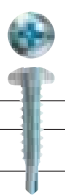

BEST SELLER



Self-Drilling Screws Hex Head

Zinc plated steel. DIN 7504K.

Part No.	Box of
AB138	400 Pieces

3 x No. 8: x 1/2", 3/4", 1". 3 x No. 10: x 1/2", 3/4", 1".
3 x No. 12: x 1", 1 1/2", 2".

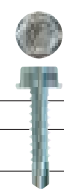

Self-Tapping Screws Countersunk - Pozi

AB Type. Zinc plated steel. DIN 7982/C/Z.

Part No.	Box of
AB63N	550 Pieces

4 x No. 6: x 5/8", 3/4", 1", 1 1/2". 4 x No. 8: x 5/8", 3/4", 1", 1 1/2".
4 x No. 10: x 5/8", 3/4", 1", 1 1/2".



BEST SELLER

Self-Tapping Screws Pan Head - Pozi (Small Sizes)

AB Type. Zinc plated steel. DIN 7981/C/Z.

Part No.	Box of
AB2	700 Pieces

1 x No. 4: x 1/2". 2 x No. 6: x 1/2", 3/4". 3 x No. 8: x 1/2", 3/4", 1".
3 x No. 10: x 1/2", 3/4", 1". 2 x No. 12: x 3/4", 1".

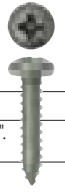

BEST SELLER

Self-Tapping Screws Pan Head - Pozi (Large Sizes)

AB Type. Zinc plated steel. DIN 7981/C/Z.

Part No.	Box of
AB94	300 Pieces

4 x No. 10: x 1/2", 3/4", 1", 1 1/2". 3 x No. 12: x 3/4", 1", 1 1/2".
2 x No. 14: x 1", 1 1/2".



Stainless Steel Self-Tapping Screws Pan Head - Pozi

AB Type. Stainless Steel. DIN 7981 Grade A2.

Part No.	Box of
AB141	450 Pieces

3 x No. 6: x 1/2", 3/4", 1". 3 x No. 8: x 1/2", 3/4", 1".
3 x No. 10: x 1/2", 3/4", 1".

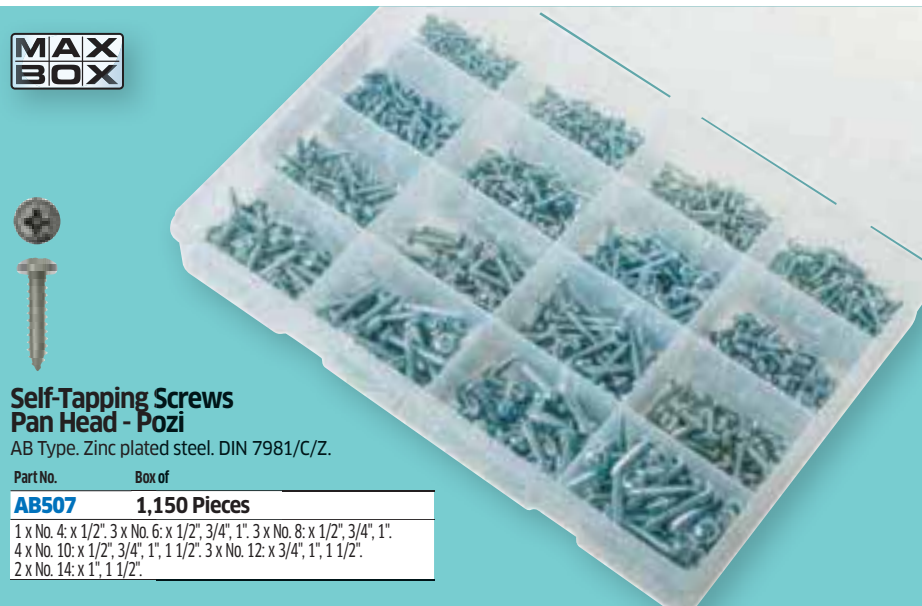

Self-Tapping Screws Pan Head - Pozi

AB Type. Zinc plated steel. DIN 7981/C/Z.

Part No.	Box of
AB507	1,150 Pieces

1 x No. 4: x 1/2". 3 x No. 6: x 1/2", 3/4", 1". 3 x No. 8: x 1/2", 3/4", 1".
4 x No. 10: x 1/2", 3/4", 1", 1 1/2". 3 x No. 12: x 3/4", 1", 1 1/2".
2 x No. 14: x 1", 1 1/2".



Looking for Screwdrivers & Bits?

Our full range of Screwdrivers and Bits start from Page 442



BEST SELLER



Multi-Use Screws Countersunk - Pozi

Zinc plated steel.

Part No. Box of

AB140 525 Pieces

3 x No. 6: x 3/4", 1", 1 1/2". 4 x No. 8: x 3/4", 1", 1 1/2", 2".
3 x No. 10: x 1 1/2", 2", 2 1/2". 1 x No. 12: x 2".



Self-Tapping Screws Flanged - Pozi Black

AB Type. Black zinc plated steel. BS 4174.

Part No. Box of

AB71 700 Pieces

2 x No. 6: x 1/2", 3/4". 4 x No. 8: x 1/2", 3/4", 1", 1 1/2".
3 x No. 10: x 1/2", 3/4", 1".



Self-Tapping Screws Flanged Pan Head - TORX® Black

AB Type. Black zinc plated steel. BS 4174.

Part No. Box of

AB168N 450 Pieces

1 x No. 6: x 5/8". 1 x No. 7: x 3/4". 3 x No. 8: x 5/8", 3/4", 1".
1 x No. 10: x 5/8".



BEST SELLER

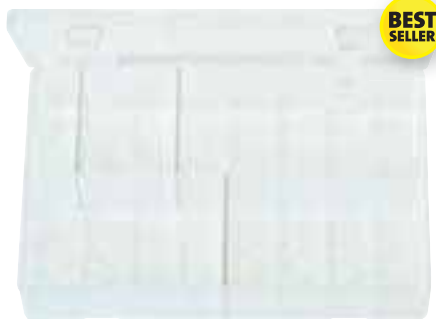

AB 'Flip Box'

Standard size transparent polypropylene box. Complete with 8 dividers. Dimensions (W x H x D): 214 x 43 x 138 mm (8 3/8" x 1 3/4" x 5 3/8").

Part No. Qty Description

ABM 1 **AB Flip Box**



Self-Tapping Screws Flanged Pan Head - Pozi

AB Type. Black zinc plated steel. BS 4174.

Part No. Box of

AB506 1,250 Pieces

6 x No. 6: x 3/8", 1/2", 5/8", 3/4", 1", 3/8".
5 x No. 8: x 1/2", 5/8", 3/4", 1", 1 1/2". 4 x No. 10: x 1/2", 5/8", 3/4", 1".



Number Plate Fasteners with Plastic Head - Short

Self tapping screws with plastic head, 4.8 x 18 mm.

Part No. Box of

AB184 260 Pieces

4 x Colours: White Yellow, Black, Blue.

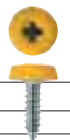

Number Plate Fasteners

White, Yellow, Black.

Part No. Box of

AB62 240 Pairs

1 x Self-Tapping Screw, Pan Head - Pozi: 8 x 3/4" (4.9 x 19 mm).
3 x Hinged Caps: White, Yellow, Black.
3 x Plastic Bolts & Nuts: White, Yellow, Black.



Security Number Plate Fasteners

Slotted One Way/Clutch Head Screws (Tamperproof).

Part No. Box of

AB222 200 Pieces

1 x Self-Tapping Screw, Pan-Head - One-Way: 8 x 3/4" (4.9 x 19 mm).
4 x Hinged Caps: White, Yellow, Black, Blue.





Sheet Metal Screws & J-Nuts

Zinc plated steel. BS 4174 (Screws).

Part No.	Box of
AB51N	350 Pieces

3 x Washer-Faced Screws: No. 8, 10, 12.
 1 x Screws with Captive Washers: No. 14.
 4 x J-Nuts: No. 8, 10, 12, 14.



BEST SELLER

Sheet Metal Screws with Captive Washer

Zinc plated steel. DIN 7976 (Screws).

Part No.	Box of
AB132	300 Pieces

2 x 8 (4.2 mm): x 1/2" (13 mm), 3/4" (19 mm).
 2 x 10 (4.8 mm): x 1/2" (13 mm), 3/4" (19 mm).
 2 x 12 (5.5 mm): x 1/2" (13 mm), 3/4" (19 mm).
 2 x 14 (6.3 mm): x 1/2" (13 mm), 3/4" (19 mm).



BEST SELLER

U-Nuts

Zinc plated steel.

Part No.	Box of
AB166	200 Pieces

10 x Sizes: No. 4, 6 (x 2), 8 (x 4), 10, 12, 14.







Sheet Metal Screws, U-Nuts & J-Nuts

Zinc plated steel. DIN 7976 (Screws), BS EN 10132 : 2000 (U-Nuts).

Part No.	Box of
AB504	600 Pieces

3 x Washer Faced Screws: 8 x 3/4" (4.2 x 19 mm), 10 x 3/4" (4.8 x 19 mm), 12 x 3/4" (5.5 x 19 mm).
 8 x Captive Washer Screws: 8 x 1/2" (4.2 x 13 mm), 8 x 3/4" (4.2 x 19 mm), 10 x 1/2" (4.8 x 13 mm),
 10 x 3/4" (4.8 x 19 mm), 12 x 1/2" (5.5 x 13 mm), 12 x 3/4" (5.5 x 19 mm), 14 x 1/2" (6.3 x 13 mm),
 14 x 3/4" (6.3 x 19 mm).
 6 x U-Nuts: No. 8 (4.2 mm) (3 x Sizes), No. 10 (4.8 mm), No. 12 (5.5 mm), No. 14 (6.3 mm).
 1 x J-Nuts: No. 14 (6.3 mm).



BEST SELLER

U-Nuts & J-Nuts

Zinc plated steel.

Part No.	Box of
AB49N	250 Pieces

5 x U-Nuts: No. 6, 8, 10, 12, 14. 4 x J-Nuts: No. 8, 10, 12, 14.



Chimney Nuts

Zinc & Black.

Part No.	Box of
AB167N	60 Pieces

1 x Zinc: M5.
 2 x Zinc: M6.
 1 x Black: M6.



BEST SELLER

Flat Clips (Push-on Fixes)

Zinc plated steel.

Part No.	Box of
AB50	1,000 Pieces

3 x Round, Imperial: 3/32", 1/8", 3/8".
 3 x Round, Metric (Imperial): 5 mm (3/16"), 6 mm (1/4"), 8 mm (5/16").
 3 x Rectangular: 3/32", 1/8", 5/32".



BEST SELLER

AB 'Flip Box'

Standard size transparent polypropylene box. Complete with 8 dividers. Dimensions (W x H x D): 214 x 43 x 138 mm (8 3/8" x 1 3/4" x 5 3/8").

Part No.	Qty	Description
ABM	1	AB Flip Box





**POP AVDEL 'Avex'
Multi-grip Rivets with Washers**
Aluminium.

Part No.	Box of
AB48N	440 Pieces

2 x Standard Flange, 3.2: x 10, 13 mm.
2 x Standard Flange, 4.0: x 12, 15 mm.
2 x Standard Flange, 4.8: x 13, 19 mm.
1 x Large Flange, 4.8: x 19 mm. 1 x Washers, M3 x 13.



Black Rivets
Black anodised aluminium.

Part No.	Box of
AB112	200 Pieces

1 x Standard Flange, 3.2 x 8 mm. 1 x Standard Flange, 4.0 x 10.
1 x Standard Flange, 4.8 x 14 mm. 1 x Large Flange, 3.2 x 10 mm.
2 x Large Flange, 4.0: x 10, 14 mm. 2 x Large Flange, 4.8: x 14, 18 mm.



**Rivets
- Sealed Type (Closed End)**
Aluminium. DIN 7337.

Part No.	Box of
AB146N	200 Pieces

5 x Sizes: 4.8 x 10, 12, 14, 16, 18 mm.



Trim Buttons

Part No.	Box of
AB151	220 Pieces

1 x Canoe Clip: FIX1.
1 x Self Pierce: FIX34.
1 x Trim Buttons: FIX35.
2 x Multi-Step: FIX30, FIX33.
3 x Fir-Tree Fixings: FIX20, FIX21, FIX29.



Fir-Tree Fixings

Part No.	Box of
AB253	180 Pieces

2 x Trim Buttons: FIX164, FIX163.
4 x Fir-Trees: FIX29, FIX20, FIX21, FIX218.



Drive Rivets

Part No.	Box of
AB152	220 Pieces

8 x Sizes: FIX31, FIX39, FIX42, FIX43, FIX44, FIX45, FIX65, FIX66.



Screw-Type Rivets

Part No.	Box of
AB172	130 Pieces

8 x Sizes: FIX31, FIX117, FIX118, FIX119,
FIX120, FIX121, FIX122, FIX123.



Locking Nuts

Part No.	Box of
AB153	220 Pieces

3 x Round: FIX9, FIX28, FIX38.
1 x Reverse Round: FIX71.
1 x Square: FIX23.
1 x Square Reverse: FIX22.
2 x Large Locking Nuts: FIX73, FIX74.



**Looking for
Trim Clip
Removal Tools?**

Our full range of
Trim Clip Removal Tools
are on Page 477



Pins



BEST SELLER



Split Pins - Imperial (Small Sizes)

Zinc plated steel.
DIN 94 / BS 1574.

Part No.	Box of
----------	--------

AB32N 800 Pieces

8 x Sizes, O.D. x Length: 1/16" x 1" (1.6 x 25 mm), 5/64" x 1" (2.0 x 25 mm), 3/32" x 1" (2.4 x 25 mm), 3/32" x 1 1/2" (2.4 x 38 mm), 7/64" x 1 1/2" (2.8 x 38 mm), 1/8" x 1 1/2" (3.2 x 40 mm), 9/64" x 1 1/2" (3.6 x 40 mm), 5/32" x 1 5/8" (4.0 x 40 mm).

BEST SELLER



Split Pins - Imperial (Large Sizes)

Zinc plated steel. DIN 94 / BS 1574.

Part No.	Box of
----------	--------

AB73 225 Pieces

5 x Sizes, O.D. x Length: 1/8" x 1 1/2" (3.2 x 38 mm), 5/32" x 2" (4.0 x 51 mm), 3/16" x 2" (4.8 x 51 mm), 1/4" x 3" (6.3 x 76 mm), 5/16" x 3" (7.9 x 76 mm).

BEST SELLER



Split Pins - Imperial & Metric

Zinc plated steel. DIN 94 / BS 1574 (Imperial).
DIN 94 / ISO 1234 (BS 7774) (Metric).

Part No.	Box of
----------	--------

AB206 370 Pieces

4 x Imperial Sizes, O.D. x Length: 1/32" x 3/8" (1.0 x 10 mm), 5/64" x 1" (2.0 x 25 mm), 9/64" x 1 1/2" (3.6 x 38 mm), 3/16" x 2" (4.8 x 51 mm).
6 x Metric Sizes, O.D. x Length: 2.0 x 14 mm (5/64" x 9/16"), 2.0 x 20 mm (5/64" x 3/4"), 2.5 x 28 mm (3/32" x 1 3/32"), 3.2 x 20 mm (1/8" x 3/4"), 3.2 x 32 mm (1/8" x 1 1/4"), 4.0 x 36 mm (5/32" x 1 3/8").

BEST SELLER



Clevis Pins

BS 1574.

Part No.	Box of
----------	--------

AB33 200 Pieces

8 x Sizes: 3/16" x 5/8", 3/16" x 7/8", 1/4" x 1 1/2", 1/4" x 1 1/16", 9/32" x 7/8", 5/16" x 1", 3/8" x 1 1/4", M6 x 20 (1/4" x 7/8").

BEST SELLER



Spring Roll Pins - Imperial

Black.

Part No.	Box of
----------	--------

AB35 300 Pieces

11 x Sizes, O.D. x Length: 3/32" x 1", 1/8" x 1", 1/8" x 1 1/2", 5/32" x 1", 5/32" x 1 1/2", 3/16" x 1", 3/16" x 1 1/2", 1/4" x 1", 1/4" x 1 1/2", 5/16" x 1", 5/16" x 2".

BEST SELLER



Spring Roll Pins - Metric

Black. DIN 1481.

Part No.	Box of
----------	--------

AB80 300 Pieces

12 x Sizes, O.D. x Length: 2.5 x 24 mm, 2.5 x 36 mm, 3 x 24 mm, 3 x 40 mm, 4 x 24 mm, 4 x 40 mm, 5 x 24 mm, 5 x 40 mm, 6 x 24 mm, 6 x 40 mm, 8 x 24 mm, 8 x 55 mm.



Split Pins - Imperial

Zinc plated steel. DIN 94 / BS 1574.

Part No.	Box of
----------	--------

AB508 850 Pieces

12 x Sizes, O.D. x Length: 1/16" x 1" (1.6 x 5 mm), 5/64" x 1" (2.0 x 25 mm), 3/32" x 1" (2.5 x 25 mm), 3/32" x 1 1/2" (2.4 x 38 mm), 7/64" x 1 1/2" (2.8 x 38 mm), 1/8" x 1 1/2" (3.2 x 38 mm), 9/64" x 1 1/2" (3.6 x 38 mm), 5/32" x 1 5/8" (4.0 x 41 mm), 5/32" x 2" (4.0 x 51 mm), 3/16" x 2" (4.8 x 51 mm), 1/4" x 3" (6.3 x 76 mm), 5/16" x 3" (7.9 x 76 mm).



Spring Roll Pins - Metric

Black. DIN 1481.

Part No.	Box of
----------	--------

AB555 340 Pieces

19 x Sizes, O.D. x Length: 3 x 20 mm, 3 x 24 mm, 3 x 30 mm, 4 x 24 mm, 4 x 28 mm, 4 x 40 mm, 4 x 50 mm, 5 x 16 mm, 5 x 20 mm, 5 x 24 mm, 5 x 28 mm, 5 x 32 mm, 5 x 35 mm, 5 x 40 mm, 5 x 45 mm, 6 x 30 mm, 6 x 45 mm, 8 x 32 mm, 8 x 45 mm.



BEST SELLER

R-Clips

Zinc plated.



Part No.	Box of
AB88N	80 Pieces
5 x Sizes (Wire Ø x Length): 2.5 x 45, 3 x 54, 4 x 75, 5 x 107, 6 x 117 mm.	

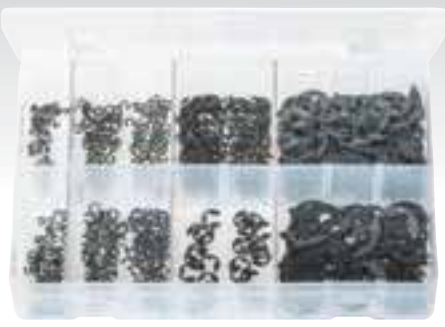

E-Retainers - Metric

DIN 6799.



Part No.	Box of
AB127N	725 Pieces
8 x Sizes (Shaft Ø): 1.7, 2.75, 3.5, 4.5, 6.0, 7.0, 13.0, 15.5 mm.	



E-Retainers - Imperial

DIN 6799 (BS 3673/2).



Part No.	Box of
AB55N	800 Pieces
10 x Sizes (Shaft Ø): 1/8", 5/32", 3/16", 7/32", 1/4", 5/16", 3/8", 7/16", 1/2", 5/8".	



Circlips Internal - Metric

DIN 472.



Part No.	Box of
AB173	230 Pieces
13 x Sizes: 11, 13, 16, 19, 21, 22, 25, 30, 35, 38, 40, 42, 47 mm.	



BEST SELLER

Circlips External - Metric

DIN 471.



Part No.	Box of
AB174	350 Pieces
16 x External Sizes: 7, 8, 10, 12, 14, 15, 17, 18, 20, 22, 24, 25, 30, 35, 40, 50 mm.	



BEST SELLER

Circlips Internal & External - Metric

DIN 472 (Internal), DIN 471 (External).



Part No.	Box of
AB37N	280 Pieces
10 x Internal Sizes: 11, 13, 16, 19, 21, 22, 25, 30, 35, 38 mm. 10 x External Sizes: 11, 13, 16, 19, 21, 22, 25, 30, 35, 38 mm.	



BEST SELLER

AB 'Flip Box'

Standard size transparent polypropylene box. Complete with 8 dividers. Dimensions (W x H x D): 214 x 43 x 138 mm (8 3/8" x 1 3/4" x 5 3/8").

Part No.	Qty	Description
ABM	1	AB Flip Box



Circlips Internal & External - Metric

DIN 472 (Internal), DIN 471 (External).

Part No.	Box of
AB561	400 Pieces
3 x Internal: 40, 42, 47 mm. 15 x External: 7, 8, 10, 12, 14, 15, 17, 18, 20, 24, 25, 30, 35, 40, 50 mm.	





Woodruff Keys - Imperial

Part No.	Box of
AB47N	96 Pieces
15 x Sizes: 1/16" x 1/2", 3/32" x 1/2", 1/8" x 1/2", 1/8" x 5/8", 5/32" x 5/8", 5/32" x 3/4", 3/16" x 3/4", 3/16" x 7/8", 3/16" x 11/8", 7/32" x 7/8", 7/32" x 11/8", 1/4" x 1", 1/4" x 1 1/8", 5/16" x 1 1/4", 3/8" x 1 1/4".	



BEST SELLER

Expansion Springs

Part No.	Box of
AB72	70 Pieces
7 x Sizes (Free Length x O.D.): 29.5 x 6.4 mm, 31.5 x 5.0 mm, 33.3 x 6.8 mm, 56.5 x 7.8 mm, 74 x 10.3 mm, 90 x 11.4 mm, 126 x 9.4 mm.	

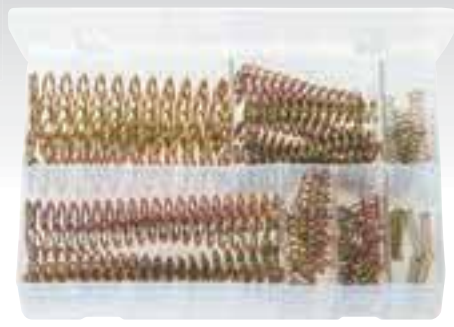

Compression Springs

Part No.	Box of
AB89	70 Pieces
10 x Sizes (Free Length x O.D.): 21.2 x 8.9 mm, 22.5 x 9.0 mm, 25 x 12.2 mm, 26.5 x 5.4 mm, 31.5 x 10.4 mm, 37 x 7.8 mm, 65.5 x 13 mm, 66 x 10.4 mm, 100 x 18.5 mm, 124 x 16.0 mm.	



Woodruff Keys & Key Steel - Metric

Part No.	Box of
AB216	24 Pieces
3 x Woodruff Keys: 4 x 6.5 x 16 mm, 4 x 9 x 22 mm, 6 x 9 x 22 mm. 4 x Key Steel, Parallel: 8 x 7 x 25 mm, 8 x 7 x 32 mm, 8 x 7 x 36 mm, 12 x 8 x 50 mm.	



JG 'Speedfit' Push-Fit Tube Couplings - Straights, Metric

Part No.	Box of
AB97N	22 Pieces
6 x Sizes: 4, 5, 6, 8, 10, 12 mm.	



Quick-Fit Couplings - Straights, Metric

Part No.	Box of
AB187	24 Pieces
6 x Sizes: 4, 5, 6, 8, 10, 12 mm.	



BEST SELLER

AB 'Flip Box'

Standard size transparent polypropylene box. Complete with 8 dividers. Dimensions (W x H x D): 214 x 43 x 138 mm (8 3/8" x 1 3/4" x 5 3/8").

Part No.	Qty	Description
ABM	1	AB Flip Box



JG 'Speedfit' Push-Fit Tube Couplings - Elbows & Tees, Metric

Part No.	Box of
AB99	17 Pieces
4 x Tees: 6, 8, 10, 12 mm. 4 x Elbows: 6, 8, 10, 12 mm.	



Quick-Fit Couplings - Elbows + Tees, Metric

Part No.	Box of
AB188	17 Pieces
4 x Tees: 6, 8, 10, 12 mm. 4 x Elbows: 6, 8, 10, 12 mm.	



Tube Couplings Brass - Metric

Part No. Box of

AB95N 27 Pieces

6 x Sizes: 4, 5, 6, 8, 10, 12 mm.



Olives Stepped - Metric

Part No. Box of

AB111N 185 Pieces

6 x Sizes: 4, 5, 6, 8, 10, 12 mm.



Olives Stepped & Barrel - Imperial

Part No. Box of

AB64N 450 Pieces

7 x Stepped: 1/8", 5/32", 3/16", 1/4", 5/16", 3/8", 1/2".
7 x Barrel: 1/8", 5/32", 3/16", 1/4", 5/16", 3/8", 1/2".



Brass Push-Fit Couplings - Straights, Metric

Part No. Box of

AB189 18 Pieces

6 x Sizes: 4, 5, 6, 8, 10, 12 mm.



Pipe Repair Kit

Part No. Box of

AB74 72 Pieces

6 x O-Clips: 7/16", 1/2", 9/16", 5/8", 3/4", 7/8".
6 x Pipe Joiners (Hose I.D.): 3/16", 1/4", 5/16", 3/8", 1/2", 5/8".



BEST SELLER

Mini Hose Clips

Part No. Box of

AB102 100 Pieces

10 x Sizes (Ø Range): 7 - 9, 8 - 10, 9 - 11, 10 - 12, 11 - 13, 12 - 14, 13 - 15, 14 - 16, 15 - 17, 16 - 18 mm.



OETIKER '167' O-Clips - Single Ear Clamps

Stainless steel. DIN 1.4301 / UNS S30400.

Part No. Box of

AB144 160 Pieces

8 x Size Ranges: 7.0 - 8.5 mm, 8.5 - 10.0 mm, 9.8 - 11.8 mm, 11.8 - 3.8 mm, 13.2 - 15.8 mm, 15.6 - 17.8 mm, 17.1 - 20.0 mm, 20.2 - 22.8 mm.



BEST SELLER

O-Clips - 2-Ear Clamps

Zinc plated steel. DIN 1.0338 / SAE 1008/1010.

Part No. Box of

AB38 140 Pieces

6 x Sizes (Ø Range): 3/8" (8 - 11 mm), 7/16" (9 - 11 mm), 1/2" (11 - 13 mm), 9/16" (13 - 15 mm), 5/8" (15 - 18 mm), 3/4" (17 - 20 mm).



Looking for Hose Tools?

A range of Hose + Tubing Tools are available from Page 208





Brake Nuts

For 3/16" pipe.



Part No.	Box of
AB45N	150 Pieces

- 2 x Brake Nuts, Short Males: 3/8" UNF x 24 TPI, 10 x 1.00 mm.
- 2 x Brake Nuts, Long Males: 3/8" UNF x 24 TPI, 10 x 1.00 mm.
- 1 x Brake Nuts, Fully Threaded Males: 10 x 1.00 mm.
- 1 x Part Threaded Males: 12 x 1.00 mm.
- 1 x Long Females: 3/8" UNF x 24 TPI, 1 x Short Females: 10 x 1.00 mm.
- 1 x Female Connector: M10 x 1.00mm.



Brake Tubing Connectors & Brake Bleed Screws - UNF & Metric

For 3/16" pipe.



Part No.	Box of
AB85N	63 Pieces

- 1 x Male Connector: 10 x 1.00 mm.
- 2 x Female Connectors: 3/8" UNF x 24 TPI, 10 x 1.00 mm.
- 2 x 3-way Connectors: 3/8" UNF x 24 TPI, 10 x 1.00 mm.
- 5 x Brake Bleed Screws: 1/4" UNF x 28 TPI, 3/8" UNF x 24 TPI, M7 x 1.00 mm, M8 x 1.25 mm, M10 x 1.00 mm.



BEST SELLER

Brake Shoe Hold-Down Kit



Part No.	Box of
AB145N	200 Pieces

- 3 x Pins, Suits: FORD, GM, ROVER.
- 2 x Washers: LOCKHEED, GIRLING.
- 4 x Springs, Suits: FORD, VAUXHALL/GM, Lockheed, BL.



Exhaust Manifold Studs & Nuts - Metric



Part No.	Box of
AB116	72 Pieces

- 2 x Nuts, Copper Flashed Steel (Size x Pitch): M8 x 1.25 mm, M10 x 1.50 mm.
- 2 x Nuts, Brass (Size x Pitch): M8 x 1.25 mm, M10 x 1.25 mm.
- 5 x Studs (Size x Pitch x Length): M8 x 1.25 mm x 37 mm, M10 x 1.25 x 37 mm, M10 x 1.50 mm x 38 mm, M10 x 1.50 mm x 52 mm, M10 x 1.50 mm x 55 mm.



Copper Sealing Washers (Diesel Injector Washers)

Copper, DIN 7603A.



Part No.	Box of
AB142	250 Pieces

- 16 x Sizes: M6 x 10 x 1.0 (BOSCH 2916 710 602), M8 x 11.5 x 1.0 (LUCAS NW5-17W4, BOSCH 2916 710 646), M10 x 13.5 x 1.0 (BOSCH 2916 710 605), M10 x 14 x 1.0 (BOSCH 2916 710 649), M10 x 20 x 1.0 (MAN/PERKINS P:2411126), M10 x 20 x 2.0 (LUCAS 5339401, PERKINS P:0920113), M12 x 16 x 1.5 (BOSCH 2916 710 607), M12 x 18 x 1.5 (BOSCH 2916 710 608), M14 x 18 x 1.5 (BOSCH 2916 710 609), M14 x 20 x 1.5 (BOSCH 2916 710 610), M16 x 20 x 1.5 (BOSCH 2916 710 611), M17 x 21 x 1.5 (BOSCH 2916 710 611, GM 14025557), M21 x 25 x 1.0 (LUCAS NW5/59), M22 x 27 x 1.0 (LUCAS NW5/60).



BEST SELLER

Sump Plug Washers



Part No.	Box of
AB117N	265 Pieces

- 4 x Copper Compression: 12 x 17 x 2.00, 14 x 20 x 2.0, 16 x 22 x 2.0, 18 x 24 x 2.0 mm.
- 4 x Flat Copper: 10 x 20 x 2.00, 12 x 17 x 1.5, 14 x 20 x 1.5, 14 x 20 x 2.0 mm.
- 2 x Aluminium: 14 x 22 x 2.0, 18 x 24 x 1.5 mm.
- 2 x Flanged Rubber O-ring: 11 x 21 2.5, 13 x 22 x 3.0 mm.
- 1 x Nitrile Rubber O-Ring: 18 x 2 NBR, 1 x Fibre: 12 x 24 x 2.0 mm.
- 1 x Bonded Seal: 16.7 x 24 mm.



Dust Covers for Vehicle Ball Joints

Black rubber. Complete with rubber O-rings.

Part No.	Box of
AB220	10 Kits
2 x Each Kit: DC1, DC2, DC3, DC4, DC5.	



Core Plugs Cup Type - Metric

Zinc plated mild steel.

Part No.	Box of
AB120	60 Pieces
10 x Sizes: 18, 22, 24, 26, 28, 30, 32, 34, 36, 48 mm.	



Core Plugs Cup Type - Imperial

Zinc plated mild steel.

Part No.	Box of
AB30N	38 Pieces
8 x Sizes: 7/8", 1 1/4", 1 1/2", 1 5/8", 1 3/4", 1 7/8" (48 mm), 1 5/16", 2".	



Accelerator & Clutch Springs

Part No.	Box of
AB29	40 Pieces
8 x Sizes (Free Length x O.D.): 53 x 12.4 mm, 61.2 x 15.4 mm, 63.4 x 13 mm, 66 x 13.1 mm, 77.4 x 23.15 mm, 82.5 x 12.95 mm, 84.2 x 10.9 mm, 86 x 13.3 mm.	



BEST SELLER

Grease Nipples - Metric & Imperial

Part No.	Box of
AB46	130 Pieces
3 x Straights (Size x Pitch): M6 x 1.00 mm, M8 x 1.00 mm, M10 x 1.00 mm. 3 x Straights: 1/4" UNF, 1/4" BSP, 1/8" BSP Gas. 1 x Straight: 1/8" BSP Gas. Button Head (Tat Type). 1 x Straight: 1/4" UNF Long. 3 x Angled 45° (Size x Pitch): M6 x 1.00 mm, M8 x 1.00 mm, M10 x 1.00 mm. 3 x Angled 45°: 1/4" UNF, 1/4" BSP, 1/8" BSP Gas.	



Grease Nipples - Metric & Imperial, Straights

Part No.	Box of
AB207N	80 Pieces
4 x Straights (Size x Pitch): M6 x 1.00 mm, M8 x 1.00 mm, M8 x 1.25 mm, M10 x 1.00 mm. 3 x Straights: 1/4" UNF, 1/4" BSP, 1/8" BSP Gas 1 x Long Straight: 1/4" UNF.	



BEST SELLER

AB 'Flip Box'

Standard size transparent polypropylene box. Complete with 8 dividers. Dimensions (W x H x D): 214 x 43 x 138 mm (8 3/8" x 1 3/4" x 5 3/8").

Part No.	Qty	Description
ABM	1	AB Flip Box



BEST SELLER

Grease Nipples - Metric

Part No.	Box of
AB115N	125 Pieces
4 x Straights (Size x Pitch): M6 x 1.00 mm, M8 x 1.00 mm, M8 x 1.25 mm, M10 x 1.00 mm. 4 x Angled 45° (Size x Pitch): M6 x 1.00 mm, M8 x 1.00 mm, M8 x 1.25 mm, M10 x 1.00 mm. 4 x Angled 90° (Size x Pitch): M6 x 1.00 mm, M8 x 1.00 mm, M8 x 1.25 mm, M10 x 1.00 mm.	



Grease Nipple - Imperial

Part No.	Box of
AB159	90 Pieces
3 x Straights: 1/4" UNF, 1/4" BSP, 1/8" BSP Gas. 3 x Angled 45°: 1/4" UNF, 1/4" BSP, 1/8" BSP Gas. 3 x Angled 90°: 1/4" UNF, 1/4" BSP, 1/8" BSP Gas. 1 x Long Straights: 1/4" UNF. 1 x Button Head (Tat Type): 1/8" BSP Gas.	





Terminals Insulated - Red & Blue with Crimping Pliers

Part No. Box of

AB43 206 Pieces

- 2 x Push-on Females: 6.3 mm Red, 6.3 mm Blue.
- 1 x Piggyback: 6.3 mm Blue.
- 2 x Push-on Males: 6.3 mm Red, 6.3 mm Blue.
- 2 x Bullets: Ø 4.0 mm Red, 5.0 mm Blue.
- 2 x Receptacle Sockets: Ø 4.0 mm Red, 5.0 mm Blue.
- 2 x Butt Connectors: 3.3 mm O.D. Red, 4.0 mm O.D. Blue.
- 3 x Rings: Ø 5.3 mm (2BA) Red, 5.3 mm (2BA) Blue, 6.4 mm (1/4") Blue.
- 1 x Crimping Pliers.



BEST SELLER



Terminals Insulated - Red & Blue

Part No. Box of

AB110N 210 Pieces

- 5 x Push-on Females: 2.8 mm Red, 4.8 mm Red, 4.8 mm Blue, 6.3 mm Red, 6.3 mm Blue.
- 1 x Push-on Female, Fully Insulated: 6.3 mm Blue.
- 2 x Push-on Males: 6.3 mm Red, 6.3 mm Blue.
- 2 x Bullets: Ø 4.0 mm Red, 5.0 mm Blue.
- 2 x Receptacle Sockets: Ø 4.0 mm Red, 5.0 mm Blue.
- 2 x Butt Connectors: 3.3 mm O.D. Red, 4.0 mm O.D. Blue.



BEST SELLER



Terminals Insulated

Part No. Box of

AB42 340 Pieces

- 5 x Push-on Females: 2.8 mm Red, 4.8 mm Blue, 6.3 mm Red, 6.3 mm Blue, 9.5 mm Yellow. 1 x Piggyback: 6.3 mm Blue.
- 2 x Push-on Males: 6.3 mm Red, 6.3 mm Blue.
- 1 x Bullet: Ø 5.0 mm Blue. 1 x Receptacle Socket: Ø 5.0 mm Blue.
- 1 x Butt Connector: 4.0 mm O.D. Blue. 4 x Rings: Ø 4.3 mm Red, 5.3 mm (2BA) Blue, 6.4 mm (1/4") Blue, 8.4 mm (5/16") Blue.
- 2 x Bullet Connectors: Single, Double.



BEST SELLER



Terminals Insulated - Red

Part No. Box of

AB160 260 Pieces

- 3 x Push-on Females: 2.8, 4.8, 6.3 mm.
- 1 x Push-on Female, Fully Insulated: 6.3 mm. 1 x Piggyback: 6.3 mm.
- 1 x Push-on Male: 6.3 mm. 1 x Bullet: Ø 4.0 mm.
- 1 x Receptacle Socket: Ø 4.0 mm. 1 x Butt Connector: 3.3 mm O.D.
- 4 x Rings: Ø 4.3 mm, 5.3 mm (2BA), 6.4 mm (1/4"), 8.4 mm (5/16").



BEST SELLER



Terminals Insulated - Blue

Part No. Box of

AB161 280 Pieces

- 2 x Push-on Females: 4.8, 6.3 mm.
- 1 x Push-on Female, Fully Insulated: 4.8 mm. 1 x Piggyback: 6.3 mm.
- 1 x Push-on Male: 6.3 mm. 1 x Bullet: Ø 5.0 mm.
- 1 x Receptacle Socket: Ø 5.0 mm. 1 x Butt Connector: 4.0 mm O.D.
- 6 x Rings: 4.3 mm, 5.3 mm (2BA), 6.4 mm (1/4"), 8.4 mm (5/16"), 10.5 mm (3/8"), 13.0 mm (1/2").



Terminals Insulated - Yellow

Part No. Box of

AB162 110 Pieces

- 2 x Push-on Females: 6.3, 9.5 mm.
- 2 x Push-on Females, Fully Insulated: 6.3, 9.5 mm.
- 1 x Push-on Male: 6.3 mm. 1 x Butt Connector: 5.5 mm O.D.
- 5 x Rings: Ø 5.3 mm (2BA), 6.4 mm (1/4"), 8.4 mm (5/16"), 10.5 mm (3/8"), 13.0 mm (1/2").



Terminals Insulated - Red

Part No. Box of

AB501 600 Pieces

- 3 x Push-on Females: 2.8, 4.8, 6.3 mm. 3 x Push-on Females, Fully Insulated: 2.8, 4.8, 6.3 mm.
- 1 x Piggyback: 6.3 mm. 1 x Push-on Male: 6.3 mm. 1 x Bullet: Ø 4.0 mm. 1 x Receptacle Socket: Ø 4.0 mm.
- 1 x Butt Connector: 3.3 mm. 1 x Pin (12 mm): Ø 1.9 mm. 1 x Blade (18 mm): 2.3 mm. 1 x Forks: 3.7 mm (4BA).
- 4 x Rings: Ø 4.3 mm, 5.3 mm (2BA), 6.4 mm (1/4"), 8.4 mm (5/16").



Terminals Insulated - Blue

Part No. Box of

AB502 600 Pieces

- 2 x Push-on Females: 4.8, 6.3 mm. 2 x Push-on Females, Fully Insulated: 4.8, 6.3 mm. 1 x Piggyback: 6.3 mm.
- 1 x Push-on Male: 6.3 mm. 1 x Bullet: Ø 5.0 mm. 1 x Receptacle Socket: Ø 5.0 mm. 1 x Butt Connector: 4.0 mm O.D.
- 2 x Forks: 3.7 mm (4BA), 5.2 mm (2BA). 1 x Blade (18 mm): 2.3 mm. 1 x Pin (12 mm): Ø 1.9 mm.
- 5 x Rings: Ø 4.3 mm, 5.3 mm (2BA), 6.4 mm (1/4"), 8.4 mm (5/16"), 10.5 mm (3/8").





Terminals Insulated

Part No. Box of
AB509 600 Pieces

4 x Push-on Females: 2.8 mm Red, 6.3 mm Red, 6.3 mm Blue, 9.5 mm Yellow.
 3 x Push-on Females, Fully Insulated: 6.3 mm Red, 6.3 mm Blue, 6.3 mm Yellow.
 1 x Piggyback: 6.3 mm Blue. 2 x Push-on Males: 6.3 mm Red, 6.3 mm Blue.
 2 x Bullets: Ø 4.0 mm Red, 5.0 mm Blue. 2 x Receptacle Sockets: Ø 4.0 mm Red, 5.0 mm Blue.
 3 x Butt Connectors: 3.3 mm Red, 4.0 mm Blue, 5.5 mm O.D. Yellow. 7 x Rings: Ø 5.3 mm (2BA) Red,
 5.3 mm (2BA) Blue, 6.4 mm (1/4") Blue, 6.4 mm (1/4") Yellow, 8.4 mm (5/16") Blue,
 8.4 mm (5/16") Yellow, 10.5 mm (3/8") Yellow.



Terminals - Non-Insulated

Part No. Box of
AB147N 150 Pieces

15 x Types: Bullets Male, Bullets Female, Push-on Males, Push-on Females (Suits VW, AUDI, VOLVO, SAAB, FORD, BMW, GM).



Heat Shrink Terminals, Adhesive Lined - Butt Connectors

Part No. Box of
AB190 220 Pieces

3 x Colours (Ø): Red (3.7 mm), Blue (5.0 mm), Yellow (6.5 mm)



Heat Shrink Terminals, Adhesive Lined - Red & Blue

Part No. Box of
AB125 130 Pieces

2 x Push-on Females: 6.3 mm Red, 6.3 mm Blue.
 2 x Push-on Males: 6.3 mm Red, 6.3 mm Blue.
 2 x Butt Connectors: Ø 3.7 mm Red, 5.0 mm Blue.
 4 x Rings, Standard Length: Ø 5.3 mm (2BA) Red, 6.4 mm (1/4") Red,
 6.4 mm (1/4") Blue, 8.4 mm (5/16") Blue.



Copper Tube Terminals

Part No. Box of
AB114N 40 Pieces

10 x Sizes (for Cable Size x Bolt Hole Size): 10 mm² x 8 mm, 16 mm² x 8 mm, 25 mm² x 6 mm, 25 mm² x 8 mm, 35 mm² x 8 mm, 35 mm² x 10 mm, 50 mm² x 8 mm, 50 mm² x 10 mm, 70 mm² x 10 mm, 70 mm² x 12 mm.



Heat Shrink Tubing - 50 mm Lengths

Polyolefin. Shrink Ratio: 2:1.

Part No. Box of
AB103 172 Pieces

4 x Sizes: 3.2, 4.8, 6.4, 12.7 mm.
 4 x Colours: Black, Blue, Red, Yellow.

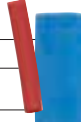

Heat Shrink Tubing - 100 mm Lengths

Polyolefin. Shrink Ratio: 2:1.

Part No. Box of
AB221 100 Pieces

2 x Sizes: 4.8, 6.4 mm.
 2 x Colours: Black, Red.

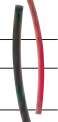

Copper Tube Butt Connectors

Part No. Box of
AB123N 110 Pieces

6 x Sizes (for Cable Diameter): 10, 16, 25, 35, 50, 70 mm².





NEW



Grommets - Wiring
Black PVC.



Part No.	Box of
AB192N	220 Pieces

7 x Sizes, for hole Ø x I.D.: 6.4 x 4.0, 9.3 x 7.7, 12.3 x 9.5, 15.8 x 12.0, 20.2 x 15.8, 25.0 x 19.5, 31.0 x 24.0 mm.

NEW



Grommets - Blanking
Black PVC.



Part No.	Box of
AB191N	220 Pieces

7 x Sizes, for hole Ø: 6.4, 9.3, 12.3, 15.8, 20.0, 25.0, 31.7 mm.

NEW



BEST SELLER

Blanking & Wiring Grommets
Black PVC.



Part No.	Box of
AB244	250 Pieces

7 x Blanking (for Holes Ø) 6.4, 9.3, 12.3, 15.8, 20.0, 25.0 mm.
7 x Wiring (for Holes Ø x I.D.) 6.4 x 4.0, 9.3 x 7.7, 12.3 x 9.5, 15.8 x 12.0, 20.2 x 15.8, 25.0 x 19.5 mm.

NEW



P-Clips
Nylon. Black.



Part No.	Box of
AB193	160 Pieces

5 x Sizes (for Cable Ø): 4.8, 6.0, 9.0, 12.0, 19.1 mm.

NEW

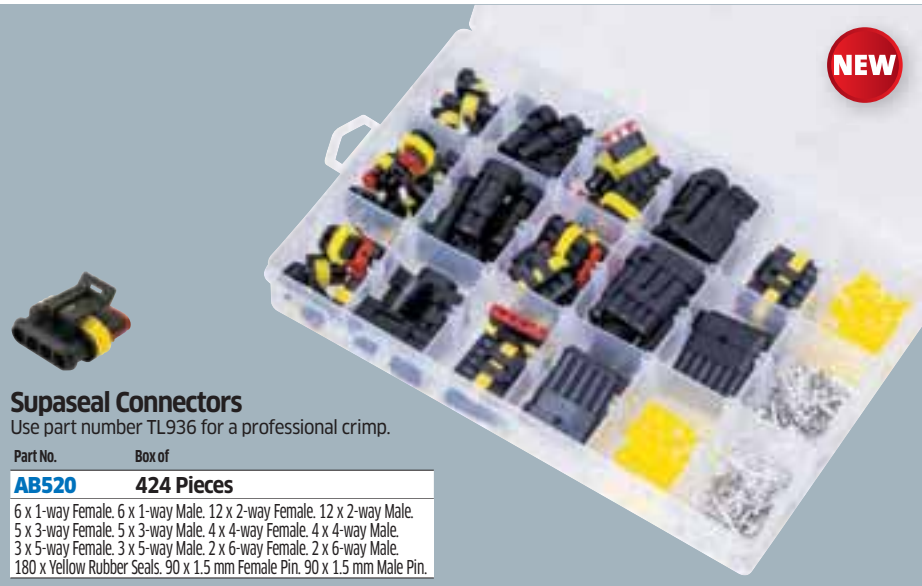

Supaseal Connectors

Use part number TL936 for a professional crimp.

Part No.	Box of
AB520	424 Pieces

6 x 1-way Female. 6 x 1-way Male. 12 x 2-way Female. 12 x 2-way Male.
5 x 3-way Female. 5 x 3-way Male. 4 x 4-way Female. 4 x 4-way Male.
3 x 5-way Female. 3 x 5-way Male. 2 x 6-way Female. 2 x 6-way Male.
180 x Yellow Rubber Seals. 90 x 1.5 mm Female Pin. 90 x 1.5 mm Male Pin.



Cable Tie Bases & Cradle Mounts

Bases: Self adhesive with 2 screw holes.
Cradle Mounts: Polyamide. Operating Temperature: -40 to 85°C.



Part No.	Box of
AB178N	120 Pieces

4 x Cradle Mounts; Sizes (Colour): 5, 9 mm (Black), 5, 9 mm (White)
4 x Cable Tie Bases, Sizes (Colour): 3.5, 4.8 mm (Black), 3.5, 4.8 mm (White)



LITTELFUSE Blade Fuses & Holders
Nylon housing.

Part No.	Box of
AB503	321 Pieces

11 x ATOF® Standard Blade Fuses: 2, 3, 4, 5, 7.5, 10, 15, 20, 25, 30, 40 A.
10 x MINI® Blade Fuses: 2, 3, 4, 5, 7.5, 10, 15, 20, 25, 30 A.
1 x ATOF® Standard Blade Fuse Holders: 20 A.
1 x MINI® Blade Fuse Holders - Splash Proof: 20 A.
1 x Standard Blade Fuse Holders - Splash Proof: 20 A.



BEST SELLER

Mini Blade Fuses

Part No. Box of
AB165N 200 Pieces

10 x Amperages: 2, 3, 4, 5, 7.5, 10, 15, 20, 25, 30 A.



BEST SELLER

Standard Blade Fuses with Fuse Holders

Part No. Box of
AB164 105 Pieces

9 x Standard Blade Fuses, Amperages: 3, 4, 5, 7.5, 10, 15, 20, 25, 30 A.
1 x Holder: White.



LED Standard Blade Fuses

RoHS. Voltage Rating: 12 or 24 V. Standard blade fuse style.
• LED on top of the fuse glows when it has blown.

- No more guesswork and testing of troublesome circuits.
- Instant identification of blown fuses - Saves time & effort.

Part No. Box of
AB224 75 Pieces

7 x Amperages: 5, 7.5, 10, 15, 20, 25, 30 A.



LITTELFUSE MINI® Blade Fuses

Nylon housing.
Part No. Box of
AB118 100 Pieces

10 x Amperages: 2, 3, 4, 5, 7.5, 10, 15, 20, 25, 30 A.



LITTELFUSE ATOF® Standard Blade Fuses with Fuse Holders

Standard type blade fuse. Nylon housing.
Part No. Box of
AB41N 120 Pieces

10 x Amperages: 2, 3, 5, 7.5, 10, 15, 20, 25, 30, 40 A.



LITTELFUSE MAXI™ Blade Fuses

Nylon housing.
Part No. Box of
AB176 29 Pieces

7 x Amperages: 20, 30, 40, 50, 60, 70, 80 A.



LITTELFUSE Low Profile MINI® Blade Fuses

Nylon housing.
Part No. Box of
AB175N 75 Pieces

7 x Amperages: 5, 7.5, 10, 15, 20, 25, 30 A.



LITTELFUSE MICRO2™ Blade Fuses

32 V. Nylon housing.
Part No. Box of
AB179 175 Pieces

7 x Amperages: 5, 7.5, 10, 15, 20, 25, 30 A.



Glass & Torpedo Fuses

Torpedo (Ceramic Type/Continental) Fuses to DIN 72581/1.

Part No. Box of
AB194 350 Pieces

8 x Glass Fuses: 2, 5, 10, 15, 20, 25, 35, 50 A.
4 x Torpedo (Ceramic Type/Continental): 5, 8, 16, 25 A.





AB 'Flip Box'

Standard size transparent polypropylene box. Complete with 8 dividers. Dimensions (W x H x D): 214 x 43 x 138 mm (8 3/8" x 1 3/4" x 5 3/8").

- Hinged lid overlaps on all sides of the box tray.
- 2 x Snap latches for secure closing.
- 8 x Removable dividers provide up to 10 compartments in various configurations.
- Boxes can be stacked or stored in a Storage Rack (Part No. ABR).

Part No.	Qty	Description
ABM	1	AB Flip Box

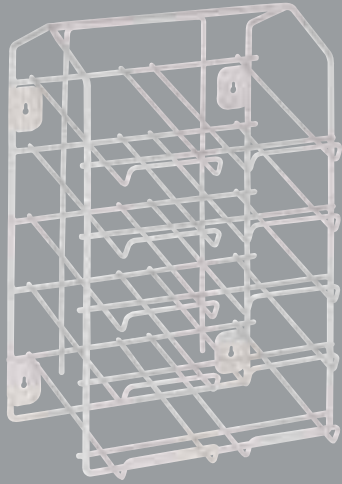

Storage Rack for AB 'Flip Box'

PVC coated wire. Dimensions (H x W x D): 460 x 300 x 210 mm. (Boxes shown NOT included).

- Holds up to 10 boxes for fast and easy retrieval.
- Can be free-standing or wall mounted.

Part No.	Qty	Description
ABR	1	Storage Rack



AB 'Max Box'

Large size transparent polypropylene compartment box. Dimensions (W x H x D): 333 x 58 x 228 mm (13 1/8" x 2 5/16" x 9").

- High strength, oil-resistant transparent polypropylene.
- Reinforced hinges and two snap latches give secure closure and prevent parts moving between compartments.
- Can be stacked or stored in Carrying Case (Part No. SB101).
- Available in 6 configurations.



Part No.	Qty	Compartments
SB112	1	12 Fixed

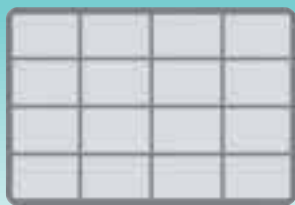

Part No.	Qty	Compartments
SB116	1	16 Fixed



Part No.	Qty	Compartments
SB118	1	18 Fixed

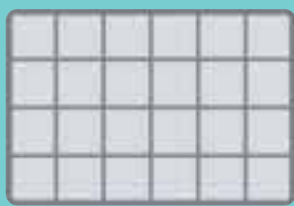

Part No.	Qty	Compartments
SB124	1	24 Fixed



Part No.	Qty	Compartments
SB106	1	6 Fixed



Part No.	Qty	Compartments
SB100	1	24 Adjustable c/w 20 Dividers



AB 'Max Box' Carrying Case

Made from cold rolled steel, finished in grey baked enamel.

- Holds up to 5 boxes (NOT included).
- Keyhole slots enable case to be wall-mounted.
- Bolt holes enable cases to be stacked.

Part No.	Qty	Description
SB101	1	Carrying Case



AB 'Max Box' Carrying Case Locking Hinge

Holds boxes in place whilst being transported. Can be locked with a padlock (NOT included). (Boxes NOT included).

Part No.	Qty	Description
SB102	1	Locking Hinge



28



32



33



37



39



40



Electrical Assembly



41



45



46

- 28 Terminals
- 34 Connectors
- 37 Grommets
- 38 Heat Shrink Tubing
- 39 Insulation Tapes
- 40 Battery Terminals
- 41 Relays
- 42 Capacitors
- 43 Switches
- 46 Fuses
- 52 Cable Accessories
- 54 Cable Ties
- 58 Cable Tools
- 61 Auto Cable
- 63 Starter + Mains Cable
- 64 Mains Cable Accessories
- 65 Plugs + Couplers
- 67 RCD Circuit Breakers
- 68 Dash Cams



52

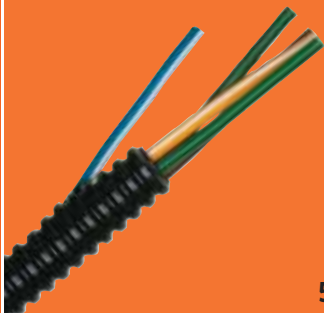

53



54



59



61



64



65



68





Red Insulated Terminals

Cable Size: 0.5 - 1.5 mm²

Push-on Females

Part No.	Pack of	Width
ET3	100	2.8 mm
ET4	100	4.8 mm
ET6	100	6.3 mm

Push-on Females, Fully Insulated

Part No.	Pack of	Width
ET44	100	2.8 mm
ET45	100	4.8 mm
ET9	100	6.3 mm

BEST SELLER

Piggybacks

Part No.	Pack of	Width
ET13	100	6.3 mm

Push-on Males

Part No.	Pack of	Width
ET36	100	6.3 mm

BEST SELLER

Push-on Males, Fully Insulated

Part No.	Pack of	Width
ET48	100	6.3 mm

Bullets

Part No.	Pack of	Ø
ET15	100	4.0 mm

BEST SELLER

Receptacle Sockets

Part No.	Pack of	Ø
ET18	100	4.0 mm

Butt Connectors

Part No.	Pack of	O.D.
ET33	100	3.3 mm
ET33K	1,000	3.3 mm

BEST SELLER

Red Insulated Terminals

Cable Size: 0.5 - 1.5 mm²

Forks

Part No.	Pack of	Width
ET51	100	3.7 mm
ET53	100	5.3 mm

Blades

Part No.	Pack of	Blade W x L
ET55	100	2.3 x 18 mm

Pins

Part No.	Pack of	Pin Ø x Length
ET57	100	1.9 x 12 mm

Rings

Part No.	Pack of	Ø
ET20	100	4.3 mm
ET22	100	5.3 mm
ET25	100	6.4 mm
ET28	100	8.4 mm

Assorted Box of Terminals Insulated - Red

Part No.	Box of
AB160	260 Pieces

3 x Push-on Females: 2.8, 4.8, 6.3 mm.
 1 x Push-on Female, Fully Insulated: 6.3 mm.
 1 x Piggyback: 6.3 mm.
 1 x Push-on Male: 6.3 mm.
 1 x Bullet: Ø 4.0 mm.
 1 x Receptacle Socket: Ø 4.0 mm.
 1 x Butt Connector: 3.3 mm O.D.
 4 x Rings: Ø 4.3 mm, 5.3 mm (2BA), 6.4 mm (1/4"), 8.4 mm (5/16").



'Max Box' Assortment of Terminals Insulated - Red

Part No.	Box of
AB501	600 Pieces

3 x Push-on Females: 2.8, 4.8, 6.3 mm. 3 x Push-on Females, Fully Insulated: 2.8, 4.8, 6.3 mm.
 1 x Piggyback: 6.3 mm. 1 x Push-on Male: 6.3 mm. 1 x Bullet: Ø 4.0 mm. 1 x Receptacle Socket: Ø 4.0 mm.
 1 x Butt Connector: 3.3 mm. 1 x Pin (1.2 mm): Ø 1.9 mm. 1 x Blade (18 mm): 2.3 mm. 1 x Forks: 3.7 mm (4BA).
 4 x Rings: Ø 4.3 mm, 5.3 mm (2BA), 6.4 mm (1/4"), 8.4 mm (5/16").



Blue Insulated Terminals

Cable Size: 1.5 - 2.5 mm²

Push-on Females

Part No.	Pack of	Width
ET5	100	4.8 mm



ET7	100	6.3 mm
------------	-----	--------



**BEST
SELLER**

Push-on Females, Fully Insulated

Part No.	Pack of	Size
ET46	100	4.8 mm



ET10	100	6.3 mm
-------------	-----	--------



**BEST
SELLER**

ET10K	1,000	6.3 mm
--------------	-------	--------

Piggybacks

Part No.	Pack of	Width
ET14	100	6.3 mm



Push-on Males

Part No.	Pack of	Ø
ET37	100	6.3 mm
ET37K	1,000	6.3 mm



**BEST
SELLER**

Bullets

Part No.	Pack of	Ø
ET16	100	5.0 mm



Receptacle Sockets

Part No.	Pack of	Ø
ET19	100	5.0 mm



Butt Connectors

Part No.	Pack of	O.D.
ET34	100	4.0 mm
ET34K	1,000	4.0 mm



**BEST
SELLER**

Forks

Part No.	Pack of	Width
ET52	100	3.7 mm



ET54	100	5.3 mm
-------------	-----	--------



Blades

Part No.	Pack of	Blade W x L
ET56	100	2.3 x 18 mm



Pins

Part No.	Pack of	Pin Ø x Length
ET58	100	1.9 x 12 mm



Blue Insulated Terminals

Cable Size: 1.5 - 2.5 mm²

Rings

Part No.	Pack of	Size
ET21	100	4.3 mm



ET23	100	5.3 mm
-------------	-----	--------



ET26	100	6.4 mm
-------------	-----	--------



ET29	100	8.4 mm
-------------	-----	--------



ET31	100	10.5 mm
-------------	-----	---------



ET42	100	13.0 mm
-------------	-----	---------



Blue Fully Insulated Terminals

Cable Size: 1.5 - 2.5 mm²

Push-on Females

Part No.	Pack of	Width
ET67	100	6.3 mm



Push-on Males

Part No.	Pack of	Width
ET47	100	6.3 mm



Assorted Box of Terminals Insulated - Blue

Part No.	Box of
AB161	280 Pieces

2 x Push-on Females: 4.8, 6.3 mm.
1 x Push-on Female, Fully Insulated: 4.8 mm.
1 x Piggyback: 6.3 mm.
1 x Push-on Male: 6.3 mm.
1 x Bullet: Ø 5.0 mm.
1 x Receptacle Socket: Ø 5.0 mm.
1 x Butt Connector: 4.0 mm O.D.
6 x Rings: 4.3 mm, 5.3 mm (2BA), 6.4 mm (1/4"),
8.4 mm (5/16"), 10.5 mm (3/8"), 13.0 mm (1/2").



**MAX
BOX**

'Max Box' Assortment of Terminals Insulated - Blue

Part No.	Box of
AB502	600 Pieces

2 x Push-on Females: 4.8, 6.3 mm. 2 x Push-on Females, Fully Insulated: 4.8, 6.3 mm. 1 x Piggyback: 6.3 mm.
1 x Push-on Male: 6.3 mm. 1 x Bullet: Ø 5.0 mm. 1 x Receptacle Socket: Ø 5.0 mm. 1 x Butt Connector: 4.0 mm O.D.
2 x Forks: 3.7 mm (4BA), 5.2 mm (2BA). 1 x Blade (18 mm): 2.3 mm. 1 x Pin (12 mm): Ø1.9 mm.
5 x Rings: Ø 4.3 mm, 5.3 mm (2BA), 6.4 mm (1/4"), 8.4 mm (5/16"), 10.5 mm (3/8").

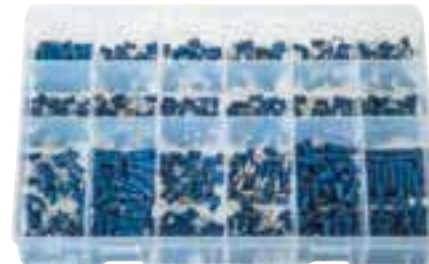



Yellow Insulated Terminals

Cable Size: 4.0 - 6.0 mm²

Push-on Females

Part No. Pack of Width



ET8 100 6.3 mm



ET12 100 9.5 mm

Push-on Females, Fully Insulated

Part No. Pack of Width



ET11 100 6.3 mm



ET49 100 9.5 mm

Push-on Males

Part No. Pack of Width



ET38 100 6.3 mm

Butt Connectors

Part No. Pack of O.D.



ET35 100 5.5 mm

Bullets

Part No. Pack of Ø



ET17 100 5.0 mm

Receptacle Sockets

Part No. Pack of Ø



ET50 100 5.0 mm

Pins

Part No. Pack of Pin Ø x Length



ET59 100 2.9 x 14 mm

Rings

Part No. Pack of Ø



ET24 100 5.3 mm



ET27 100 6.4 mm



ET30 100 8.4 mm



ET32 100 10.5 mm



ET43 100 13.0 mm



Assorted Box of Terminals Insulated - Yellow

Part No. Box of

AB162 110 Pieces

2 x Push-on Females: 6.3, 9.5 mm.
2 x Push-on Females, Fully Insulated: 6.3, 9.5 mm.
1 x Push-on Male: 6.3 mm.
1 x Butt Connector: 5.5 mm O.D.
5 x Rings: Ø 5.3 mm (2BA), 6.4 mm (1/4"), 8.4 mm (5/16"), 10.5 mm (3/8"), 13.0 mm (1/2").



'Max Box' Assortment of Terminals Insulated

Part No. Box of

AB509 600 Pieces

4 x Push-on Females: 2.8 mm Red, 6.3 mm Red, 6.3 mm Blue, 9.5 mm Yellow.
3 x Push-on Females, Fully Insulated: 6.3 mm Red, 6.3 mm Blue, 6.3 mm Yellow.
1 x Piggyback: 6.3 mm Blue.
2 x Push-on Males: 6.3 mm Red, 6.3 mm Blue.
2 x Bullets: Ø 4.0 mm Red, 5.0 mm Blue.
2 x Receptacle Sockets: Ø 4.0 mm Red, 5.0 mm Blue.
3 x Butt Connectors: 3.3 mm Red, 4.0 mm Blue, 5.5 mm O.D. Yellow.
7 x Rings: Ø 5.3 mm (2BA) Red, 5.3 mm (2BA) Blue, 6.4 mm (1/4") Blue, 6.4 mm (1/4") Yellow, 8.4 mm (5/16") Blue, 8.4 mm (5/16") Yellow, 10.5 mm (3/8") Yellow.



Assorted Box of Terminals Insulated

Part No. Box of

AB42 340 Pieces

5 x Push-on Females: 2.8 mm Red, 4.8 mm Blue, 6.3 mm Red, 6.3 mm Blue, 9.5 mm Yellow.
1 x Piggyback: 6.3 mm Blue.
2 x Push-on Males: 6.3 mm Red, 6.3 mm Blue.
1 x Bullet: Ø 5.0 mm Blue.
1 x Receptacle Socket: Ø 5.0 mm Blue.
1 x Butt Connector: 4.0 mm O.D. Blue.
4 x Rings: Ø 4.3 mm Red, 5.3 mm (2BA) Blue, 6.4 mm (1/4") Blue, 8.4 mm (5/16") Blue.
2 x Bullet Connectors: Single, Double.



Assorted Box of Terminals Insulated - Red & Blue

Part No. Box of

AB110N 210 Pieces

5 x Push-on Females: 2.8 mm Red, 4.8 mm Red, 4.8 mm Blue, 6.3 mm Red, 6.3 mm Blue.
1 x Push-on Female, Fully Insulated: 6.3 mm Blue.
2 x Push-on Males: 6.3 mm Red, 6.3 mm Blue.
2 x Bullets: Ø 4.0 mm Red, 5.0 mm Blue.
2 x Receptacle Sockets: Ø 4.0 mm Red, 5.0 mm Blue.
2 x Butt Connectors: 3.3 mm O.D. Red, 4.0 mm O.D. Blue.



Assorted Box of Terminals Insulated - Red & Blue with Crimping Pliers

Part No. Box of

AB43 206 Pieces

2 x Push-on Females: 6.3 mm Red, 6.3 mm Blue.
1 x Piggyback: 6.3 mm Blue.
2 x Push-on Males: 6.3 mm Red, 6.3 mm Blue.
2 x Bullets: Ø 4.0 mm Red, 5.0 mm Blue.
2 x Receptacle Sockets: Ø 4.0 mm Red, 5.0 mm Blue.
3 x Butt Connectors: 3.3 mm O.D. Red, 4.0 mm O.D. Blue.
3 x Rings: Ø 5.3 mm (2BA) Red, 5.3 mm (2BA) Blue, 6.4 mm (1/4") Blue.
1 x Crimping Pliers.



Bullets & Connectors

Brass Bullets

Part No.	Pack of	Ø	Hole Ø
ET39	100	4.6 mm	2.0 mm



Bullet Connectors

Part No.	Pack of	Type	Hole Ø
ET1	100	Single	4.6 mm



Bullet Connectors

Part No.	Pack of	Type	Holes Ø
ET2	100	Double	4.6 mm



Non-Insulated Terminals

Push-on Females - 2.8 mm Brass

Part No.	Pack of	For Cable
ET423	50	0.75 - 1.50 mm ²

Suits: BMW.



Push-on Females - 6.3 mm Zinc

Part No.	Pack of	For Cable
ET420	50	0.50 - 1.00 mm ²

Suits: VW/AUDI/VOLVO/FORD/BMW/GM.



**BEST
SELLER**

Push-on Females - 6.3 mm Brass

Part No.	Pack of	For Cable
ET60	100	1.00 - 2.50 mm



Push-on Females - 6.3 mm Zinc

Part No.	Pack of	For Cable
ET421	50	1.00 - 2.50 mm ²

Suits: VW/AUDI/VOLVO/FORD/BMW/GM.



Push-on Males - 6.3 mm Zinc

Part No.	Pack of	For Cable
ET429	50	0.50 - 1.00 mm ²

Suits: VW/AUDI/VOLVO/FORD/BMW/GM.



Push-on Males - 6.3 mm Brass

Part No.	Pack of	For Cable
ET61	100	1.00 - 2.50 mm

Suits: VW/AUDI/VOLVO/FORD/BMW/GM.



Push-on Males - 6.3 mm Zinc

Part No.	Pack of	For Cable
ET428	50	1.00 - 2.50 mm ²



Bullets Male - 4.0 mm Ø

Part No.	Pack of	For Cable
ET401	100	0.50 - 2.00 mm ²



Bullets Female - 4.0 mm Ø

Part No.	Pack of	For Cable
ET402	100	0.50 - 2.00 mm ²



Flags - 6.3 mm

Part No.	Pack of	For Cable
ET432	50	1.50 - 2.50 mm ²



Non-Insulated Terminal Covers

Push-on Female

Part No.	Pack of	For Cable	Fits Width
ET41	100	Up to 2.50 mm ²	6.3 mm



Female Bullet

Part No.	Pack of	For Cable	Fits Ø
ET482	100	0.50 - 2.00 mm ²	4 mm



Male Bullet

Part No.	Pack of	For Cable	Fits Ø
ET481	100	0.50 - 2.00 mm ²	4 mm



Non-Insulated Terminals

Bullets Male - 1.6 mm Ø

Part No.	Pack of	For Cable
ET410	20	0.50 - 1.00 mm ²

Suits: VW/AUDI/SAAB/FORD/BMW.



Bullets Female - 1.6 mm Ø

Part No.	Pack of	For Cable
ET409	20	0.50 - 1.00 mm ²

Suits: VW/AUDI/SAAB/FORD/BMW.



Bullets Male - 1.6 mm Ø

Part No.	Pack of	For Cable
ET408	20	0.75 - 1.50 mm ²

Suits: SAAB/FORD/BMW.



Bullets Female - 1.6 mm Ø

Part No.	Pack of	For Cable
ET407	20	0.75 - 1.50 mm ²

Suits: SAAB/FORD/BMW.



Bullets Male - 3.5 mm Ø

Part No.	Pack of	For Cable
ET404	20	0.50 - 1.00 mm ²

Suits: VW/AUDI/VOLVO/SAAB/BMW.



Bullets Female - 3.5 mm Ø

Part No.	Pack of	For Cable
ET405	20	0.50 - 1.00 mm ²

Suits: VW/AUDI/VOLVO/SAAB/BMW.



Bullets Male - 3.5 mm Ø

Part No.	Pack of	For Cable
ET403	20	1.00 - 2.50 mm ²

Suits: VW/AUDI/VOLVO/SAAB/BMW.



Bullets Female - 3.5 mm Ø

Part No.	Pack of	For Cable
ET406	20	1.00 - 2.50 mm ²

Suits: VW/AUDI/VOLVO/SAAB/BMW.



Terminals - 4.8 mm

Part No.	Pack of	For Cable
ET491	20	0.50 - 2.00 mm ²

Suits: VW/AUDI/VOLVO/SAAB/FORD/BMW/GM.



Terminals - 4.8 mm

Part No.	Pack of	For Cable
ET492	20	1.50 - 2.50 mm ²

Suits: VW/AUDI/VOLVO/SAAB/FORD/BMW/GM.



Red Heat Shrink Terminals, Adhesive Lined

Cable Size: 0.5 - 1.5 mm²



Push-on Females

Part No.	Pack of	Width
ET204	25	6.3 mm



Push-on Males

Part No.	Pack of	Width
ET203	25	6.3 mm



Rings

Standard length.

Part No.	Pack of	Ø	
ET201	25	5.3 mm	(2BA)
ET202	25	6.4 mm	(1/4")



Butt Connectors

Part No.	Pack of	Ø
ET91	25	3.7 mm
ET91A	100	3.7 mm
ET91K	1,000	3.7 mm

Blue Heat Shrink Terminals, Adhesive Lined

Cable Size: 1.5 - 2.5 mm²



Push-on Females

Part No.	Pack of	Width
ET224	25	6.3 mm



Push-on Males

Part No.	Pack of	Width
ET223	25	6.3 mm



Rings

Standard length.

Part No.	Pack of	Ø	
ET221	25	6.4 mm	(1/4")
ET222	25	8.4 mm	(5/16")



Butt Connectors

Part No.	Pack of	Ø
ET92	25	5.0 mm
ET92A	100	5.0 mm
ET92K	1,000	5.0 mm

Assorted Box of Heat Shrink Terminals, Adhesive Lined - Red & Blue

Part No.	Box of
AB125	130 Pieces

2 x Push-on Females: 6.3 mm Red, 6.3 mm Blue.
 2 x Push-on Males: 6.3 mm Red, 6.3 mm Blue.
 2 x Butt Connectors: Ø 3.7 mm Red, 5.0 mm Blue.
 4 x Rings, Standard Length: Ø 5.3 mm (2BA) Red, 6.4 mm (1/4") Red, 6.4 mm (1/4") Blue, 8.4 mm (5/16") Blue.



Assorted Box of Heat Shrink Terminals, Adhesive Lined - Butt Connectors

Part No.	Box of
AB190	220 Pieces

3 x Colours (Ø): Red (3.7 mm), Blue (5.0 mm), Yellow (6.5 mm)



Heat Shrink Butt Connectors - Solder Type

Shrink ratio: 3:1.

Part No.	Pack of	Stripe Colour	For Cable
ET301	10	Clear	0.1 - 0.5 mm ²
ET302	10	Red	0.5 - 1.0 mm ²
ET303	10	Blue	1.0 - 2.5 mm ²
ET304	10	Yellow	2.5 - 6.0 mm ²

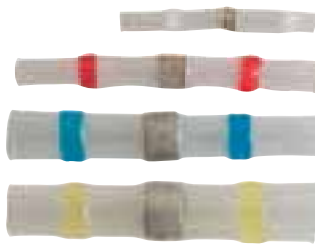

Yellow Heat Shrink Terminals, Adhesive Lined

Cable Size: 4.0 - 6.0 mm²



Rings

Standard length.

Part No.	Pack of	Ø	
ET241	25	6.4 mm	(1/4")
ET242	25	8.4 mm	(5/16")



Butt Connectors

Part No.	Pack of	Ø
ET93	10	6.5 mm



Windproof Jet Flame Torch

Refills with standard butane gas chargers (suits Part No. SAS50). Colour/model may vary.

- Windproof jet flame

Part No.	Qty	Description
TL130	1	Jet Flame Torch



Crocodile Clips - Non-Insulated

Part No.	Pack of	Amperage
ECC25	25	25 A
ECC50	25	50 A



Crocodile Clips - Red & Black Insulated Grips

Part No.	Pack of	Amperage
ECC5	24 (12 x Each Colour)	5 A



Looking for Supaseal Connectors?

Our brand new range of Supaseal Connectors are on pages 36-37



Need a Crimping Tool?

Wiring Tools are on Pages 58-60



Copper Tube Butt Connectors

Part No.	Pack of	Cable Size	(Cable Entry Ø)
ET80	25	10 mm ²	(4.5 mm)
ET81	25	16 mm ²	(5.4 mm)
ET82	25	25 mm ²	(6.8 mm)
ET83	10	35 mm ²	(8.2 mm)
ET84	10	50 mm ²	(9.5 mm)
ET85	10	70 mm ²	(11.2 mm)



Assorted Box of Copper Tube Butt Connectors

Part No.	Box of
AB123N	110 Pieces

6 x Sizes (for Cable Diameter): 10, 16, 25, 35, 50, 70 mm².



Copper Tube Terminals (Cable Lugs)

Part No.	Pack of	Cable Ø x Bolt Hole	(Cable Entry Ø)
ET69	10	10 mm ² x 8 mm	(4.5 mm)
ET62	50	10 mm ² x 12 mm	(4.5 mm)
ET70	10	16 mm ² x 8 mm	(5.4 mm)
ET79	50	16 mm ² x 12 mm	(5.4 mm)
ET71	10	25 mm ² x 6 mm	(6.8 mm)
ET72	10	25 mm ² x 8 mm	(6.8 mm)
ET63	50	25 mm ² x 12 mm	(6.8 mm)
ET73	10	35 mm ² x 8 mm	(8.8 mm)
ET74	10	35 mm ² x 10 mm	(8.8 mm)
ET64	20	35 mm ² x 12 mm	(8.8 mm)
ET75	10	50 mm ² x 8 mm	(9.5 mm)
ET76	10	50 mm ² x 10 mm	(9.5 mm)
ET77	10	70 mm ² x 10 mm	(11.2 mm)
ET78	10	70 mm ² x 12 mm	(11.2 mm)
ET65	1	120 mm ² x 16 mm	(15.0 mm)
ET66	1	185 mm ² x 12 mm	(19.0 mm)
ET68	1	240 mm ² x 12 mm	(21.0 mm)



Assorted Box of Copper Tube Terminals

Part No.	Box of
AB114N	40 Pieces

10 x Sizes (for Cable Size x Bolt Hole Size):
 10 mm² x 8 mm, 16 mm² x 8 mm, 25 mm² x 6 mm,
 25 mm² x 8 mm, 35 mm² x 8 mm, 35 mm² x 10 mm,
 50 mm² x 8 mm, 50 mm² x 10 mm, 70 mm² x 10 mm,
 70 mm² x 12 mm.





Multiple Connectors

For 6.3 mm male terminals.
Suits Part No. ET61.

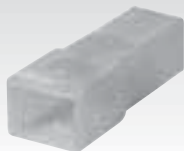

Single Female Housing

Part No.	Pack of	Dimensions (H x L x W)
ETB621	25	9.0 x 32.5 x 12.8 mm



2-way Female Housing

Part No.	Pack of	Dimensions (H x L x W)
ETB622	25	13.5 x 32.5 x 15.5 mm



2-way (T-shape) Female Housing

Part No.	Pack of	Dimensions (H x L x W)
ETB622T	25	20.0 x 32.5 x 2.5 mm



3-way Female Housing

Part No.	Pack of	Dimensions (H x L x W)
ETB623	25	20.4 x 31.7 x 15.2 mm



4-way Female Housing

Part No.	Pack of	Dimensions (H x L x W)
ETB624	25	17.1 x 32.5 x 27.9 mm

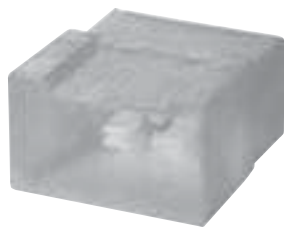

6-way Female Housing

Part No.	Pack of	Dimensions (H x L x W)
ETB626	25	18.1 x 32.3 x 31.5 mm

Multiple Connectors

For 6.3 mm female terminals.
Suits Part No. ET60.



Single Male Housing

Part No.	Pack of	Dimensions (H x L x W)
ETB611	25	6.5 x 21.4 x 10.0 mm



2-way Male Housing

Part No.	Pack of	Dimensions (H x L x W)
ETB612	25	10.0 x 23.0 x 12.8 mm



2-way (T-shape) Male Housing

Part No.	Pack of	Dimensions (H x L x W)
ETB612T	25	10.0 x 23.0 x 12.8 mm



3-way Male Housing

Part No.	Pack of	Dimensions (H x L x W)
ETB613	25	18.0 x 22.8 x 15.2 mm



4-way Male Housing

Part No.	Pack of	Dimensions (H x L x W)
ETB614	25	14.0 x 22.9 x 23.9 mm



6-way Male Housing

Part No.	Pack of	Dimensions (H x L x W)
ETB616	25	15.0 x 24.0 x 37.6 mm

Push-on Males - 6.3 mm Brass

Part No.	Pack of	For Cable
ET61	100	1.00 - 2.50 mm

Suits: VW/AUDI/VOLVO/FORD/BMW/GM.



Push-on Females - 6.3 mm Brass

Part No.	Pack of	For Cable
ET60	100	1.00 - 2.50 mm



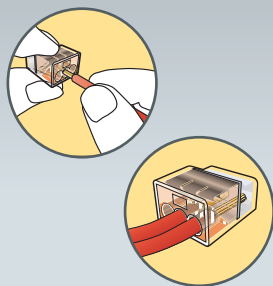

HELLERMANN TYTON 'Helacon' Mini Wire Connectors

450v 24A. Transparent wire connectors.
Suitable for 2.5 mm² solid and stranded cable.

- Voltage test entry on the front guarantees safety during application, installation and maintenance.
- Provides a proper fixing that can be optically checked through the transparent housing.

Part No.	Pack of	Type	Colour
ETB102	100	2 Hole	Yellow
ETB103	100	3 Hole	Orange
ETB104	75	4 Hole	Clear
ETB105	50	5 Hole	Light Blue
ETB106	50	6 Hole	Purple
ETB108	40	8 Hole	Black



'Helacon' mini wire connectors are used for fast, easy and reliable connection and distribution of cable and conductors. Simply insert the cable completely into the connect. A double spring mechanism provides a secure installation and will support fitters especially in awkward situations like difficult-to-reach areas and overhead work. To change or correct a wire, simply hold and twist it left and right while pulling the connector.



Terminal Blocks - 12-Way

Part No.	Pack of	Amperage
ETB2.5	10 Blocks	2.5 A
ETB5	10 Blocks	5 A
ETB15	10 Blocks	15 A
ETB30	10 Blocks	30 A



Ceramic Terminal Block

76A, 450V. Temperature rating: 500°C.

Part No.	Qty	Type	Cable Size
ETB50	1	2 Pole	16 mm ²



3M

3M 'Scotchlok' Connectors

Part No.	Pack of	Colour	3M No.
ESL1	100	Red	No. 905



3M

**BEST
SELLER**



3M 'Scotchlok' Connectors

Part No.	Pack of	Colour	3M No.
ESL2	100	Blue	No. 560

3M



3M 'Scotchlok' Connectors - 'T' Tap

Part No.	Pack of	Colour	3M No.
ESL5	50	Blue	No. 952

3M

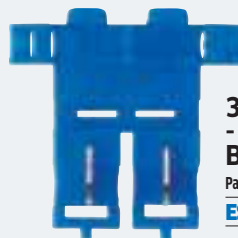

3M 'Scotchlok' Connectors - Self-Stripping Blade Fuse Holders

Part No.	Pack of	Colour	3M No.
ESL6	20	Blue	No. 972



Snap-Lock Connectors

Part No.	Pack of	Colour
ESL51	100	Red

**BEST
SELLER**



Snap-Lock Connectors

Part No.	Pack of	Colour
ESL52	100	Blue



Supaseal Connectors

Ideal for applications where a waterproof joint/seal is required for electrical cabling.

The system comprises of the connector, the pin and the seal and is suitable for cable sizes from 0.5 mm² to 1.5mm².

Use Part No. TL936 for a professional crimp.



Supaseal Pins

Part No.	Qty	Size	Type
ET513	50	1.5 mm	Female
ET514	50	1.5 mm	Male

Supaseal Rubber Seals

Part No.	Qty	Colour
ET512	50	Yellow

NEW RANGE

Supaseal Male 1-way Connectors

Part No.	Qty	Contacts	Type
ET501	10	1-way	Male



Supaseal Male 2-way Connectors

Part No.	Qty	Contacts	Type
ET503	10	2-way	Male



Supaseal Male 3-way Connectors

Part No.	Qty	Contacts	Type
ET505	10	3-way	Male



Supaseal Male 4-way Connectors

Part No.	Qty	Contacts	Type
ET507	10	4-way	Male



Supaseal Male 5-way Connectors

Part No.	Qty	Contacts	Type
ET509	10	5-way	Male



Supaseal Male 6-way Connectors

Part No.	Qty	Contacts	Type
ET511	10	6-way	Male



NEW



Assorted Box of Supaseal Connectors

Part No.	Box of
AB520	424 Pieces
6 x 1-way Female. 6 x 1-way Male. 12 x 2-way Female. 12 x 2-way Male. 5 x 3-way Female. 5 x 3-way Male. 4 x 4-way Female. 4 x 4-way Male. 3 x 5-way Female. 3 x 5-way Male. 2 x 6-way Female. 2 x 6-way Male. 180 x Yellow Rubber Seals. 90 x 1.5 mm Female Pin. 90 x 1.5 mm Male Pin.	



Supaseal Crimping Pliers - Ratchet Type

- Ergonomically designed handle for ease of use
- Ratchet ensures correct crimping pressure
- Crimp range 0.5mm - 2.0mm²

Part No.	Qty	Description
TL936	1	Ratchet Crimping Pliers



NEW RANGE

Supaseal Female 1-way Connectors

Part No.	Qty	Contacts	Type
ET500	10	1-way	Female



Supaseal Female 2-way Connectors

Part No.	Qty	Contacts	Type
ET502	10	2-way	Female



Supaseal Female 3-way Connectors

Part No.	Qty	Contacts	Type
ET504	10	3-way	Female



Supaseal Female 4-way Connectors

Part No.	Qty	Contacts	Type
ET506	10	4-way	Female



Supaseal Female 5-way Connectors

Part No.	Qty	Contacts	Type
ET508	10	5-way	Female



Supaseal Female 6-way Connectors

Part No.	Qty	Contacts	Type
ET510	10	6-way	Female



Wiring Grommets

Black PVC. Fits 1.6 mm panel thickness.

Part No.	Pack of	Size	For Hole x I.D.
EG28	100	6 mm	6.4 x 4.0 mm
EG29	100	9 mm	9.3 x 7.7 mm
EG30	100	12 mm	12.3 x 9.5 mm
EG31	100	16 mm	15.8 x 12.0 mm
EG32	100	20 mm	20.2 x 15.8 mm
EG33	100	25 mm	25.0 x 19.5 mm
EG34	100	32 mm	31.0 x 24.0 mm
EG35	100	38 mm	37.4 x 31.5 mm
EG36	100	50 mm	50.5 x 44.5 mm

**NEW RANGE**

Assorted Box of Grommets - Wiring

Black PVC.

Part No.	Box of
AB192N	220 Pieces

7 x Sizes, for hole Ø x I.D.: 6.4 x 4.0, 9.3 x 7.7, 12.3 x 9.5, 15.8 x 12.0, 20.2 x 15.8, 25.0 x 19.5, 31.0 x 24.0 mm.



Blanking Grommets

Black PVC. Fits 1.6 mm panel thickness.

Part No.	Pack of	Size	For Hole x O.D.
EG1	100	6 mm	6.4 x 8.5 mm
EG2	100	9 mm	9.3 x 13.4 mm
EG3	100	12 mm	12.3 x 16.2 mm
EG4	100	16 mm	15.8 x 19.0 mm
EG5	100	20 mm	20.0 x 24.2 mm
EG6	100	25 mm	25.0 x 29.2 mm
EG7	100	32 mm	31.7 x 38.1 mm
EG8	100	38 mm	37.7 x 44.4 mm
EG9	100	50 mm	50.5 x 57.2 mm



Assorted Box of Grommets - Blanking

Black PVC.

Part No.	Box of
AB191N	220 Pieces

7 x Sizes, for hole Ø: 6.4, 9.3, 12.3, 15.8, 20.0, 25.0, 31.7 mm.



Assorted Box of Blanking & Wiring Grommets

Black PVC.

Part No.	Box of
AB244	250 Pieces

7 x Blanking (for Holes Ø) 6.4, 9.3, 12.3, 15.8, 20.0, 25.0 mm.
7 x Wiring (for Holes Ø x I.D.) 6.4 x 4.0, 9.3 x 7.7, 12.3 x 9.5, 15.8 x 12.0, 20.2 x 15.8, 25.0 x 19.5 mm.

Easy-Fit Grommet

Black PVC. Fits 1.6 mm panel thickness.

Part No.	Pack of	Size	For Hole x I.D.
EG37	100	20 mm	19.5 x 16.8 mm
EG38	100	25 mm	24.5 x 22.3 mm



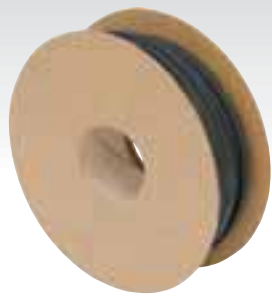

Heat Shrink Tubing - Black

Polyolefin. Shrink Ratio: 2:1.

Part No.	Length	I.D. (Pre Shrink)
EHS13	11 m	3.2 mm
EHS41	25 m	3.2 mm
EHS14	10 m	4.8 mm
EHS42	20 m	4.8 mm
EHS43	15 m	6.4 mm
EHS44	15 m	9.5 mm
EHS45	10 m	12.7 mm



Heat Shrink Tubing - Red

Polyolefin. Shrink Ratio: 2:1.

Part No.	Length	I.D. (Pre Shrink)
EHS13RE	11 m	3.2 mm
EHS41RE	25 m	3.2 mm
EHS14RE	10 m	4.8 mm
EHS42RE	20 m	4.8 mm
EHS43RE	15 m	6.4 mm
EHS44RE	15 m	9.5 mm
EHS45RE	10 m	12.7 mm



Assorted Pack of Heat Shrink Tubing - 200 mm Lengths

Polyolefin. Shrink Ratio: 2:1.

Part No.	Pack of
AP33	30 Pieces

4 x Sizes: 3.2, 4.8, 6.4, 12.7 mm. 5 x Colours: Black, Blue, Red, White & Yellow.



Adhesive Lined Heat Shrink Tubing - Black

Polyolefin. Shrink Ratio: 3:1.

Part No.	Length	I.D. (Pre Shrink)
EHS61	1.22 m	4.8 mm
EHS62	1.22 m	9.5 mm
EHS63	1.22 m	12.7 mm
EHS64	1.22 m	19.1 mm

Assorted Box of Heat Shrink Tubing - 50 mm Lengths

Polyolefin. Shrink Ratio: 2:1.

Part No.	Box of
AB103	172 Pieces

4 x Sizes: 3.2, 4.8, 6.4, 12.7 mm.
4 x Colours: Black, Blue, Red, Yellow.



Assorted Box of Heat Shrink Tubing - 100 mm Lengths

Polyolefin. Shrink Ratio: 2:1.

Part No.	Box of
AB221	100 Pieces

2 x Sizes: 4.8, 6.4 mm. 2 x Colours: Black, Red.



Self-Fusing Silicone Rubber Tape

RoSH compliant to 2022/95/EC.

- No Adhesive.
- Withstands temperatures: +260°C (+500°F).
- Remains flexible to -60°C (-85°F).
- 700 PSI tensile strength.
- Insulates to 8,000 Volts per layer.
- Stretches 300%.



Part No.	Qty	Colour	Width x Length
VC415	1	Black	25 mm x 3 m



Non-Adhesive Loom Tape

NON adhesive PVC.

Part No.	Pack of	Colour	Width x Length
EPTS	2	Black	19 mm x 33 m





BEST SELLER

PVC Insulation Tape

19 mm Wide x 20 m Long.
Flame Retardant to BS EN 60454 Type 2.

Part No.	Pack of	Colour
EPT1	10	Black
EPT11	10	Blue
EPT17	10	Brown
EPT12	10	Green
EPT13	10	Green/Yellow Stripe
EPT18	10	Grey
EPT14	10	Red
EPT15	10	White
EPT16	10	Yellow



BEST SELLER

Assorted Pack of PVC Insulation Tape

19 mm Wide x 20 m Long. Flame Retardant to BS EN 60454 Type 2.

Part No.	Pack of
EPT3	10 Pieces

5 x Colours: (2 x) Blue, Green, Red, White, Yellow.



BEST SELLER

ADVANCE Polyisobutylene Self-Amalgamating Tape

For insulation, termination and sealing. Quickly fuses into a solid mass with excellent weathering characteristics and high dielectric strength. High resistance to ozone, water and protective against corrosion.

Part No.	Pack of	Colour	Width x Length
EPT4	2	Black	19 mm x 10 m



Loom Tape - Linen

Natural rubber adhesive system.

Part No.	Pack of	Colour	Width x Length
EPT6	2	Black	19 mm x 50 m



BEST SELLER

PVC Tape - 2" Wide

Part No.	Qty	Colour	Width x Length
EPT2	1	Black	50 mm x 33 m



BEST SELLER

NITTO '21A' PVC Insulation Tape

0.20 mm Tape Thickness (200 Micron).

Part No.	Pack of	Colour	Width x Length
EPT21	10 Rolls	Black	19 mm x 20 m



BEST SELLER

ADVANCE 'AT7' PVC Insulation Tape

Flame Retardant to BS EN 60454 Type 2.

Part No.	Pack of	Colour	Width x Length
EPT7	10 Rolls	Black	19mm x 20 m



ADVANCE High Temperature 'AT74' PVC Insulation Tape

Flame retardant, high temperature PVC electrical insulation tape. 0.15 mm Tape Thickness (150 Micron).

Part No.	Pack of	Colour	Width x Length
EPT74	10 Rolls	Black	19 mm x 33 m



Looking for More Adhesive Tapes?

Our new expanded range is on Pages 319-323



BEST SELLER



Battery Terminals - Twin Screw

Plated brass.

Part No.	Pack of	Polarity	Cable	Entry Ø
BT1	10	+ Positive	25 mm ²	8.5 mm
BT2	10	- Negative	25 mm ²	8.5 mm

BEST SELLER



Battery Terminals - Twin Screw

Plated brass.

Part No.	Pack of	Polarity	Cable	Entry Ø
BT3	10	+ Positive	60 mm ²	10.5 mm
BT4	10	- Negative	60 mm ²	10.5 mm



Battery Terminals - Post Type with Nuts

Plated brass.

Part No.	Pack of	Polarity	Post Size
BT25	5	+ Positive	M10
BT26	5	- Negative	M10



Battery Terminals - Twin Screw

Plated brass.

Part No.	Pack of	Polarity	Cable	Entry Ø
BT21	5	+ Positive	70 mm ²	14.0 mm
BT22	5	- Negative	70 mm ²	14.0 mm

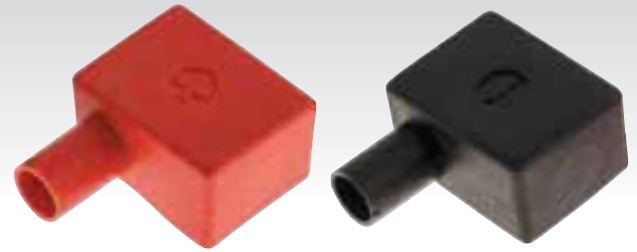

PVC Battery Terminal Covers - L-Shape Left Entry

For cable up to 50 mm² (14 mm Ø). Suits Part No.s BT1, BT2, BT3 & BT4.

Part No.	Pack of	Colour/Polarity	Cable Up To	Entry Ø
BT2	10	Red + Positive	50 mm ²	14 mm
BTC1	10	Black - Negative	50 mm ²	14 mm

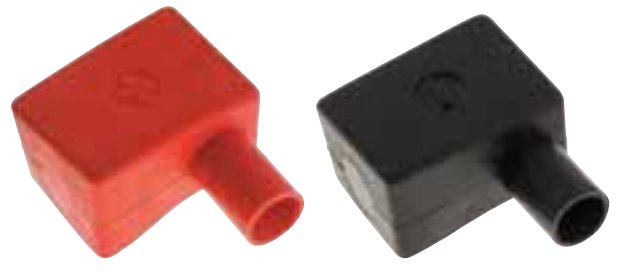

PVC Battery Terminal Covers - L-Shape Right Entry

For cable up to 50 mm² (14 mm Ø). Suits Part No.s BT1, BT2, BT3 & BT4.

Part No.	Pack of	Colour/Polarity	Cable Up To	Entry Ø
BTC4	10	Red + Positive	50 mm ²	14 mm
BTC3	10	Black - Negative	50 mm ²	14 mm



Battery Terminals - Post Type with Wing Nuts

Plated brass. Suitable for FORD Cargo.

Part No.	Pack of	Polarity	Post Size
BT23	5	+ Positive	M10
BT24	5	- Negative	M10



Battery Terminals - Offset Type

Plated brass.

Part No.	Pack of	Polarity
BT27	5	+ Positive
BT28	5	- Negative



Plug-In Bases with SAE Configuration 9-Pole for Relays

Takes 5 x 6.3 mm, 4 x 2.8 mm.

Part No.	Pack of	Description
ERL100	10	Relay Plug-In Bases



S-A-S Battery Terminal Protector

Suitable for use on batteries and earthing straps in cars, buses, trains and plant hire equipment.

- Protects against corrosion
- Improves electrical continuity thus improving starting
- Contains an indicator to visualise acid leaks (turns red)
- Waterproofs terminals

Part No.	Pack of	Size
SAS3	6	500ml Aerosols



KS TOOLS Battery Terminal Cleaning Tool

Made from forged aluminium with steel milled inserts.

- Removes corrosion from car battery terminal (+).
- Scraper for battery positive terminal (+).
- Scraper for battery negative terminal (-).
- Conical mill for battery terminals (+ and -).

Part No.	Qty	Description
K700.1195	1	Battery Terminal Cleaning Tool



Battery Retaining Bracket Sets

Zinc plated. Universal application.

Part No.	Pack of	Description
BT7	10	Bracket Sets



Relay - 4 Pin High Temperature Design

Complete with metal fixing plate and 30 amp blade fuse (standard type).

Part No.	Qty	Volts	Amps
ERL5	1	DC 12V	30 A

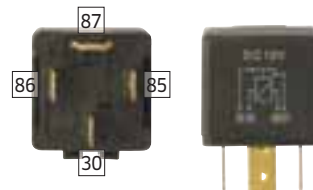

Relay - 4 Pin

Complete with metal fixing plate.

Part No.	Qty	Volts	Amps	Contact Type
ERL1	1	DC 12V	30 A	Normally Open

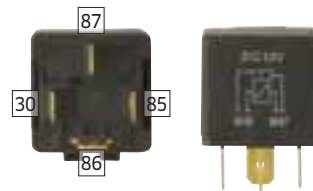

Relay - 4 Pin

Complete with metal fixing plate.

Part No.	Qty	Volts	Amps	Contact Type
ERL11	1	DC 12V	40 A	Normally Open

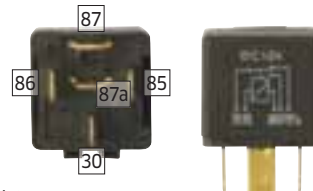

Relay - 5 Pin

Complete with metal fixing plate.

Part No.	Qty	Volts	Amps	Contact Type
ERL7	1	DC 12V	20/30 A	Normally Open

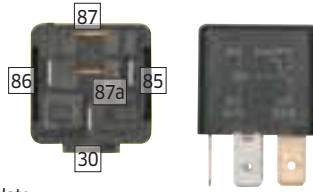

Relay - 5 Pin Change Over

Complete with metal fixing plate

Part No.	Qty	Volts	Amps
ERL4	1	DC 24V	10/20 A

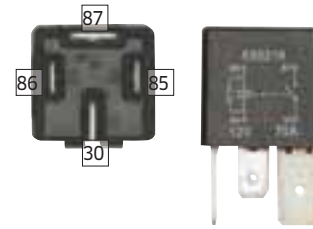

Relay - 4 Pin Make & Break

Part No.	Qty	Volts	Amps
ERL6	1	DC 12V	70 A

Looking for Battery Cables?

See the Auto Cable range on Page 63





Motor Run Capacitor - Spade Connectors

EN 60252-1 VDE approved. RoHS.
Plastic case with 6.3 x 0.8 mm fast-on terminals
(6.4 mm spade connectors) to PN-EN6120.
M8 x 10 mm thread complete with M8 serrated nut.

Part No.	Qty	Rated Capacitance	Dia x Body Length
CPR14	1	14uF	35 x 83 mm
CPR16	1	16uF	35 x 83 mm
CPR20	1	20uF	40 x 83 mm
CPR25	1	25uF	45 x 83 mm
CPR30	1	30uF	45 x 83 mm
CPR35	1	35uF	50 x 83 mm
CPR40	1	40uF	45 x 119 mm



Motor Run Capacitor - Cable Lead Connectors

EN 60252-1 VDE approved. RoHS.
Plastic case with 2-core cable lead according to PN-91/E-90103.
M8 x 10 mm thread complete with M8 serrated nut.

Part No.	Qty	Rated Capacitance	Dia x Body Length
CPR14M	1	14uF	40 x 70 mm
CPR25M	1	25uF	45 x 78 mm
CPR40M	1	40uF	45 x 114 mm
CPR50M	1	50uF	45 x 114 mm
CPR60M	1	60uF	50 x 119 mm
CPR70M	1	70uF	55 x 119 mm
CPR80M	1	80uF	60 x 119 mm

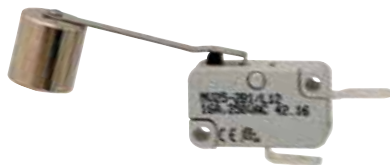

Heater Tip Over Safety Cut Out Switch

16A, 250VAC. Turns a heater off if turned over.

Part No.	Qty	Description
EC15	1	Safety Cut Out Switch



12V Illuminated Indicator Light

Fits 12 mm round hole, 6.3 mm male blade terminals.

Part No.	Pack of	Colour
EC85	10	Red
EC82	10	Amber
EC84	10	Green
EC83	10	Blue



12V LED Warning Light - Round

Fits 20 mm round hole, 6.3 mm male blade terminals.

Part No.	Pack of	Colour
EC88A	1	Red
EC88	10	Red
EC89A	1	Amber
EC89	10	Amber
EC91	10	Green
EC90A	1	Blue
EC90	10	Blue



Heater & Vacuum On/Off Switches

16(4)A, 250VAC. Panel cut out 'A' style: 27.2 x 22.3 mm.

Part No.	Qty	Switch Colour
EC13	1	Black
EC14	1	Illuminated Red



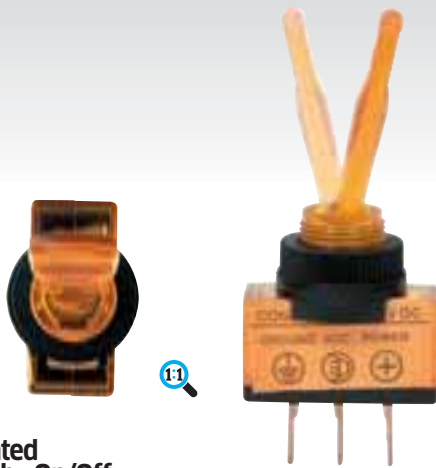

12V Illuminated Toggle Switch - On/Off

Fits 12.5 mm round hole, 20A. (*NOT Illuminated).

Part No.	Pack of	Colour
EC9	10	Black *
EC77	10	Red
EC74A	1	Amber
EC74	10	Amber
EC76A	1	Green
EC76	10	Green
EC75A	1	Blue
EC75	10	Blue



12V LED Metal Toggle Switch - On/Off

Fits 12.5 mm round hole, 25A, Silver contacts. Heavy Duty, 6.3 mm male blade terminals.

Part No.	Pack of	Colour
EC66	10	Red
EC63	10	Amber
EC65	10	Green
EC64	10	Blue



12V LED Spot Rocker Switch - On/Off

Fits 12.5 mm hole, 16A. 6.3 mm blade terminals.

Part No.	Pack of	Colour
EC73	10	Red
EC70	10	Amber
EC72	10	Green
EC71A	1	Blue
EC71	10	Blue



12V LED Rocker Switch - On/Off

Fits 12.5 mm hole, 16A. 6.3 mm blade terminals.

Part No.	Pack of	Colour
EC81	10	Red
EC78A	1	Amber
EC78	10	Amber
EC80	10	Green



Looking for RCD Switches?

A range of Circuit Breakers starts from Page 66



Actual Size Images





12V Metal Toggle Switch - On/Off

Fits 12.5 mm round hole, 25A, Silver contacts. Heavy Duty, 6.3 mm male blade terminals.

Part No.	Pack of	Type
EC67	10	On/Off

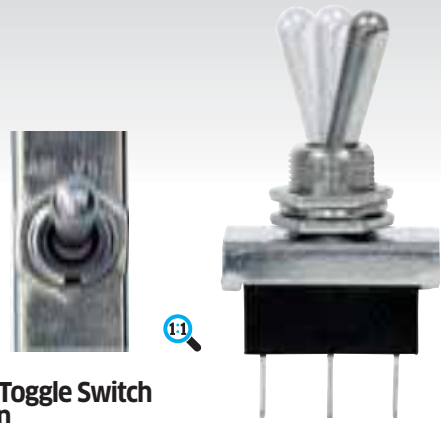

12V Metal Toggle Switch - On/Off/On

Fits 12.5 mm round hole, 25A, Silver contacts. Heavy Duty, 6.3 mm male blade terminals.

Part No.	Pack of	Type
EC68	10	On/Off/On



12V LED Metal Toggle Switch - On/Off

Fits 12.5 mm round hole, 25A, Silver contacts. Heavy Duty, 6.3 mm male blade terminals.

Part No.	Pack of	Colour
EC66	10	Red
EC63	10	Amber
EC65	10	Green
EC64	10	Blue



12V Push Button Switch - Brass

20A. Fits 19 mm round hole. Vandal resistant. Zinc plated.

Part No.	Pack of	Description
EC86	5	Push Switches



12V Push Button Switch - Heavy Duty

Fits 26 mm round hole 16A. Plastic. Stays on while the button is pressed.

Part No.	Pack of	Description
EC87	10	Push Switches



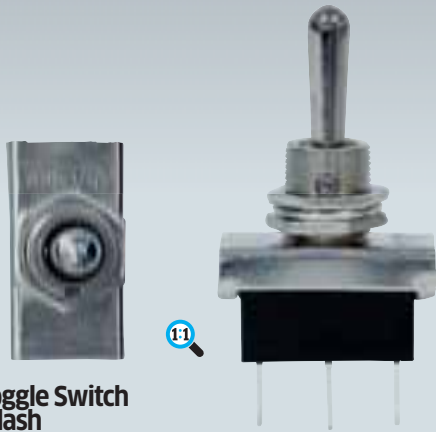

12V Metal Toggle Switch - Flash/Off/Flash

Fits 12.5 mm round hole, 25A, Silver contacts. Heavy Duty, 6.3 mm male blade terminals.

Part No.	Pack of	Type
EC69	10	Flash/Off/Flash

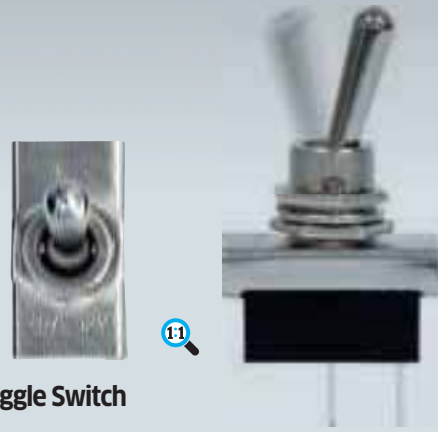

12V Metal Toggle Switch - Flash/Off

Fits 12.5 mm round hole, 25A, Silver contacts. Heavy Duty, 6.3 mm male blade terminals.

Part No.	Pack of	Type
EC62	10	Flash/Off



12V/24V Push/Pull Switch

Fits 8 mm round hole, 16A @ 12V, 8A @ 24V, screw terminals.

Part No.	Pack of	Type
EC60	10	Long Neck



12V/24V Push/Pull Switch

Fits 8 mm round hole, 16A @ 12V, 8A @ 24V, screw terminals.

Part No.	Pack of	Type
EC61	10	Short Neck

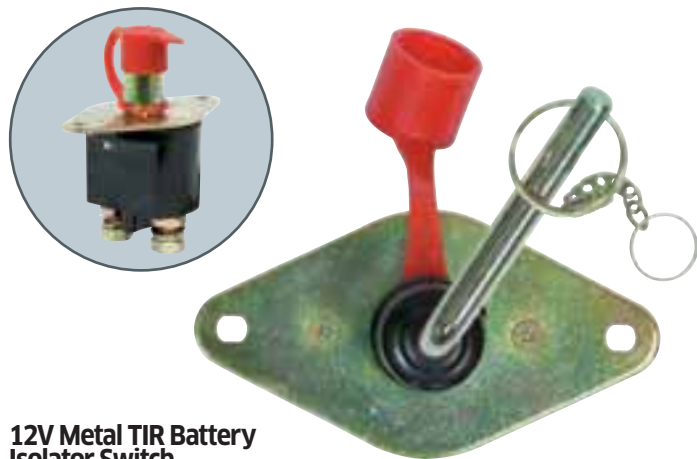

12V Metal TIR Battery Isolator Switch

250 A continuous, 2500 A for 10 seconds. Heavy duty. (Image shown NOT actual size).

Part No.	Qty	Description
EC94	1 Set	Switch & Key
EC95	1	Spare Key

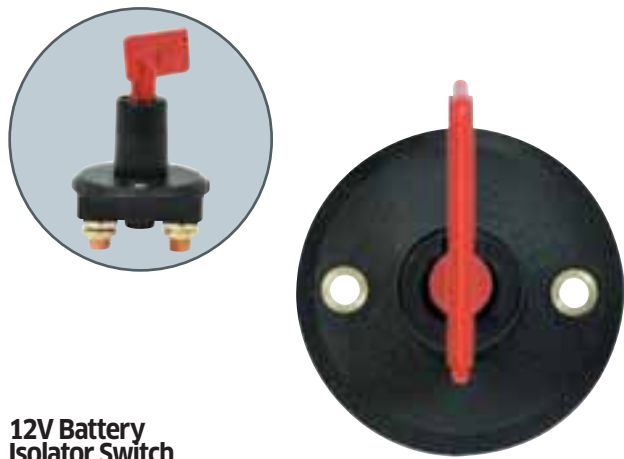

12V Battery Isolator Switch

100 A continuous, 500 A for 5 seconds. (Image shown NOT actual size).

Part No.	Qty	Description
EC92	1 Set	Switch & Key
EC93	5	Spare Keys





LITTELFUSE ATOF® Standard Blade Fuses

Nylon housing.



Part No.	Pack of	Amperage
EFB1	50	1 A
EFB2	50	2 A
EFB3	50	3 A
EFB4	50	4 A
EFB5	50	5 A
EFB7.5	50	7.5 A
EFB10	50	10 A
EFB15	50	15 A
EFB20	50	20 A
EFB25	50	25 A
EFB30	50	30 A
EFB40	50	40 A

BEST SELLER



Standard Blade Fuses

Part No.	Pack of	Amperage
EFX3	50	3 A
EFX4	50	4 A
EFX5	50	5 A
EFX7.5	50	7.5 A
EFX10	50	10 A
EFX10K	1,000	10 A
EFX15	50	15 A
EFX15K	1,000	15 A
EFX20	50	20 A
EFX20K	1,000	20 A
EFX25	50	25 A
EFX30	50	30 A

Assorted Box of LITTELFUSE ATOF® Standard Blade Fuses with Fuse Holders

Standard type blade fuse. Nylon housing.

Part No.	Box of
AB41N	120 Pieces

10 x Amperages: 2, 3, 5, 7.5, 10, 15, 20, 25, 30, 40 A.



Assorted Box of Standard Blade Fuses with Fuse Holders

Part No.	Box of
AB164	105 Pieces

9 x Standard Blade Fuses, Amperages: 3, 4, 5, 7.5, 10, 15, 20, 25, 30 A.
1 x Holder: White.



'Max Box' Assortment of LITTELFUSE Blade Fuses & Holders

Part No.	Box of
AB503	321 Pieces

11 x ATOF® Standard Blade Fuses: 2, 3, 4, 5, 7.5, 10, 15, 20, 25, 30, 40 A.
10 x MINI® Blade Fuses: 2, 3, 4, 5, 7.5, 10, 15, 20, 25, 30 A.
1 x ATOF® Standard Blade Fuse Holders: 20 A.
1 x MINI® Blade Fuse Holders - Splash Proof: 20 A.
1 x Standard Blade Fuse Holders - Splash Proof: 20 A.



LED Standard Blade Fuses

RoHS. Voltage Rating: 12 or 24V.
Standard blade fuse style.

- LED on top of the fuse glows when it has blown.
- No more guesswork and testing of troublesome circuits.
- Instant identification of blown fuses - Saves time & effort.



Part No.	Pack of	Amperage
EFX203	25	3 A
EFX204	25	4 A
EFX205	25	5 A
EFX207	25	7 A
EFX210	25	10 A
EFX215	25	15 A
EFX220	25	20 A
EFX225	25	25 A
EFX230	25	30 A

Standard Blade Fuse Circuit Breakers

RoHS. Voltage Rating: 28V DC.
Standard size blade fuse style.

- Manual trip/reset button on top of the fuse.

Part No.	Pack of	Amperage
EFX305	5	5 A
EFX307	5	7.5 A
EFX310	5	10 A
EFX315	5	15 A
EFX320	5	20 A
EFX325	5	25 A
EFX330	5	30 A



Assorted Box of LED Standard Blade Fuses

RoHS. Voltage Rating: 12 or 24V.
Standard blade fuse style.

Part No.	Box of
AB224	75 Pieces

7 x Amperages: 5, 7.5, 10, 15, 20, 25, 30 A.



Actual Size
Images



LITTELFUSE In-Line ATOF® Standard Blade Fuse Holders

Part No.	Pack of	Amperage	Cable Size
EFH20	10	● 20 A	2 mm ²
EFH30	10	● 30 A	3 mm ²

BEST SELLER



LITTELFUSE In-Line ATOF® Standard Blade Fuse Holders - Splash Proof

Part No.	Pack of	Amperage	Cable Size
EFH5	10	● 20 A	1.5 mm ²
EFH530	10	● 30 A	3 mm ²

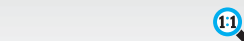

In-Line Standard Blade Fuse Holders

Part No.	Pack of	Amps	Cable Size
EFH150	10	● 20A	2 mm ²

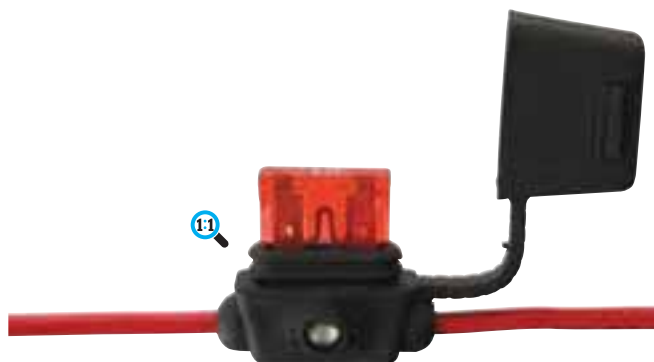

LED In-Line Standard Blade Fuse Holders - Splash Proof

RoHS. Voltage Rating: 12 or 24 V. Fitted lid prevents water ingress. For use with standard blade fuses.

- Built-in LED glows when fuse has blown.

Part No.	Pack of	Amperage	Cable Size
EFH220	10	● 20A	2 mm ²
EFH230	10	● 30A	3 mm ²



'Add A Circuit' Standard Blade Fuse Holders

Extension board for an additional fuse protected tap from an existing standard type blade fuse socket. The two fuses for the existing and the new circuit are stored horizontally.

Part No.	Qty	Description
EFH50	10	'Add A Circuit' Fuse Holder



BEST SELLER

Standard Blade Fuse Holders

Part No.	Pack of	Colour
EFH6	10	White



LITTELFUSE Blade Fuse Extractor & Tester

For testing ATOF® (standard type), MINI® & Low Profile MINI® blade fuses.

Part No.	Pack of	Description
EFBX	3	Extractor/Testers



Standard Blade Fuse Holders

Can be clipped together to make a multiple fuse box.

Part No.	Pack of	Description
EFH8	10	Fuse Holders
EFH9	10	Clear Covers
EFH10	10	Fixing Plates





1:1

LITTELFUSE Low Profile MINI® Blade Fuses

Also known as 'Micro' fuses. Nylon housing.

Part No.	Pack of	Amperage
EFL105	25	5 A
EFL107	25	7.5 A
EFL110	25	10 A
EFL115	25	15 A
EFL120	25	20 A
EFL125	25	25 A
EFL130	25	30 A

Assorted Box of LITTELFUSE Low Profile MINI® Blade Fuses

Part No.	Box of
AB175N	75 Pieces

7 x Amperages: 5, 7.5, 10, 15, 20, 25, 30 A.



1:1

LITTELFUSE MICRO2™ Blade Fuses

32 V. Nylon housing.

Part No.	Pack of	Amperage
EFBM25	25	5 A
EFBM27.5	25	7.5 A
EFBM210	25	10 A
EFBM215	25	15 A
EFBM220	25	20 A
EFBM225	25	25 A
EFBM230	25	30 A

Assorted Box of LITTELFUSE MICRO2™ Blade Fuses

32 V. Nylon housing.

Part No.	Box of
AB179	175 Pieces

7 x Amperages: 5, 7.5, 10, 15, 20, 25, 30 A.



BEST SELLER

1:1



Mini Blade Fuses

Part No.	Pack of	Amperage
EFX102	50	2 A
EFX103	50	3 A
EFX104	50	4 A
EFX105	50	5 A
EFX107	50	7.5 A
EFX110	50	10 A
EFX110K	1,000	10 A
EFX115	50	15 A
EFX115K	1,000	15 A
EFX120	50	20 A
EFX120K	1,000	20 A
EFX125	50	25 A
EFX130	50	30 A

Assorted Box of Mini Blade Fuses

Part No.	Box of
AB165N	200 Pieces

10 x Amperages: 2, 3, 4, 5, 7.5, 10, 15, 20, 25, 30 A.



In-Line Mini Blade Fuse Holders - Splash Proof

Part No.	Pack of	Amps	Cable Size
EFH140	10	● 20A	2 mm ²



1:1

LITTELFUSE MICRO3™ Blade Fuses

32 V. Nylon housing.

Part No.	Pack of	Amperage
EFBM35	25	5 A
EFBM37.5	25	7.5 A
EFBM310	25	10 A
EFBM315	25	15 A



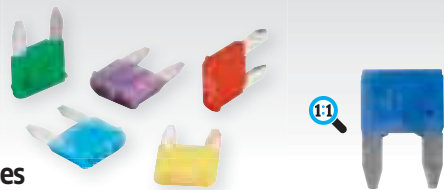

LITTELFUSE MINI® Blade Fuses

Nylon housing.

Part No.	Pack of	Amperage
EFB102	25	2 A
EFB103	25	3 A
EFB104	25	4 A
EFB105	25	5 A
EFB107	25	7.5 A
EFB110	25	10 A
EFB115	25	15 A
EFB120	25	20 A
EFB125	25	25 A
EFB130	25	30 A



LITTELFUSE MAXI™ Blade Fuses

Nylon housing.

Part No.	Pack of	Amperage
EFB220	10	20 A
EFB230	10	30 A
EFB240	10	40 A
EFB250	10	50 A
EFB260	10	60 A
EFB270	10	70 A
EFB280	10	80 A

Assorted Box of LITTELFUSE MINI® Blade Fuses

Nylon housing.

Part No.	Box of
AB118	100 Pieces

10 x Amperages: 2, 3, 4, 5, 7.5, 10, 15, 20, 25, 30 A.



Assorted Box of LITTELFUSE MAXI™ Blade Fuses

Nylon housing.

Part No.	Box of
AB176	29 Pieces

7 x Amperages: 20, 30, 40, 50, 60, 70, 80 A.



LITTELFUSE In-Line MINI® Blade Fuse Holders - Splash Proof

Part No.	Pack of	Amperage	Cable Size
EFH4	10	● 20 A	2.1 mm ²
EFH430	10	● 30 A	3.3 mm ²



LITTELFUSE MAXI™ Fuse Holder

Part No.	Qty	Description
EFH7	1	Fuse Holder



LED in-Line Mini Blade Fuse Holders - Splash Proof

RoHS. Voltage Rating: 12 or 24 V.

Fitted lid prevents water ingress. For use with mini blade fuses.

• Built-in LED glows when fuse has blown.

Part No.	Pack of	Amperage	Cable Size
EFH120	10	● 20A	2 mm ²
EFH130	10	● 30A	3 mm ²



LITTELFUSE MAXI™ Fuse Holder - Splash Proof

80 amp. For Cable size 4-6 mm².

Part No.	Qty	Description
EFH84	1	Fuse Holder





LITTELFUSE
JCASE® Cartridge Fuses

Standard type.

Part No.	Pack of	Amperage
EFJ20	10	20 A
EFJ30	10	30 A
EFJ40	10	40 A
EFJ50	10	50 A
EFJ60	10	60 A



LITTELFUSE
PAL Auto Fuses - Type 293

Part No.	Pack of	Amperage
EFA320	10	20 A
EFA340	10	40 A
EFA360	10	60 A

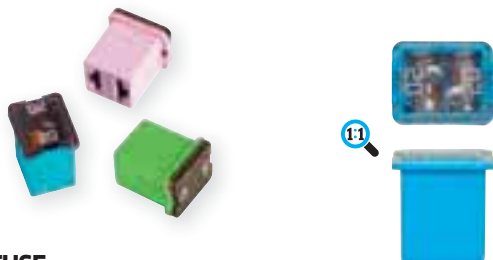

LITTELFUSE
Low Profile JCASE® Cartridge Fuses

Standard type.

Part No.	Pack of	Amperage
EFJ120	10	20 A
EFJ130	10	30 A
EFJ140	10	40 A
EFJ150	10	50 A
EFJ160	10	60 A

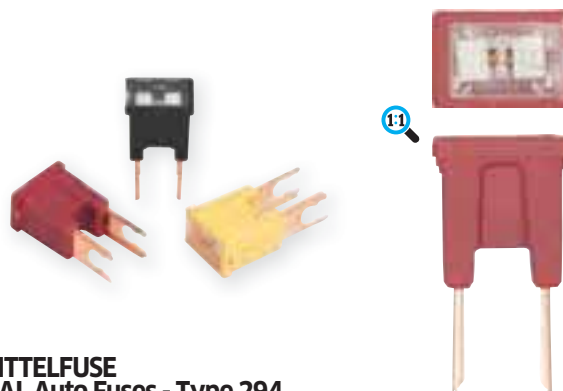

LITTELFUSE
PAL Auto Fuses - Type 294

Part No.	Pack of	Amperage
EFA150	10	50 A
EFA160	10	60 A
EFA180	10	80 A



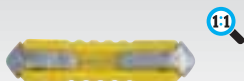

Torpedo Fuses

Torpedo (Ceramic Type/Continental) Fuses to DIN 72581/1.

Part No.	Pack of	Amperage	Colour
EFC5	100	5 A	Yellow
EFC8	100	8 A	White
EFC16	100	16 A	Red
EFC25	100	25 A	Blue

Assorted Box of Glass & Torpedo Fuses

Torpedo (Ceramic Type/Continental) Fuses to DIN 72581/1.

Part No. Box of

AB194 350 Pieces

8 x Glass Fuses: 2, 5, 10, 15, 20, 25, 35, 50 A.

4 x Torpedo (Ceramic Type/Continental): 5, 8, 16, 25 A.

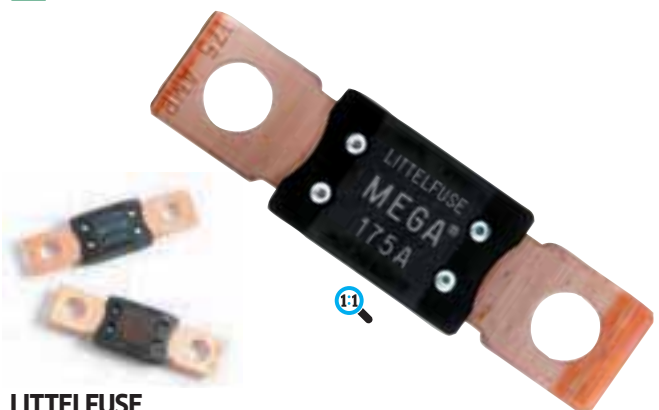

LITTELFUSE MEGA™ Fuse 32V

Bolt-down fuses. Voltage Rating: 32 VDC. Complies to ISO 8820-5

Part No.	Pack of	Amperage
EFM150	10	150 A
EFM175	10	175 A
EFM250	10	250 A
EFM500	10	500 A



Domestic Mains Fuses

BS 1362.

Part No.	Pack of	Amperage
EFD3	50	3 A
EFD5	50	5 A
EFD13	50	13 A



Looking for a new plug?

A range of plugs and trailing sockets are on Page 64

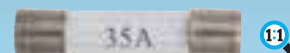

Glass Fuses

Part No.	Pack of	Amperage	Length
EFG2	100	2 A	30 mm
EFG5	100	5 A	30 mm
EFG10	100	10 A	30 mm
EFG15	100	15 A	30 mm
EFG20	100	20 A	30 mm
EFG25	100	25 A	30 mm
EFG35	100	35 A	30 mm
EFG50	100	50 A	30 mm

Assorted Box of Glass & Torpedo Fuses

Torpedo (Ceramic Type/Continental) Fuses to DIN 72581/1.

Part No. Box of

AB194 350 Pieces

8 x Glass Fuses: 2, 5, 10, 15, 20, 25, 35, 50 A.

4 x Torpedo (Ceramic Type/Continental): 5, 8, 16, 25 A.



Glass Fuse Holders

In-line type with insulated connectors.

Part No.	Pack of	Amperage	Cable Size
EFH1	10	8 A	1 mm ²
EFH11	10	17 A	2 mm ²

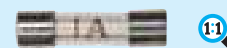

Mini Glass Fuses

Radio type.

Part No.	Pack of	Amperage	Length
EFG101	50	1 A	25 mm
EFG102	50	2 A	25 mm





Cable Tie Bases - Plastic

Self-adhesive with 2 screw holes.

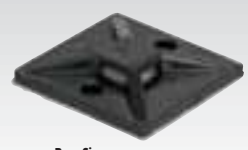

Part No.	Pack of	For Tie Width	Colour	Base Size
EAC9BK	50	3.5 mm	Black	19 mm x 19 mm
EAC4BK	50	4.8 mm	Black	28 mm x 28 mm

Cable Tie Bases - Plastic

Self-adhesive with 2 screw holes.



Part No.	Pack of	For Tie Width	Colour	Base Size
EAC9	50	3.5 mm	White	19 mm x 19 mm
EAC4	50	4.8 mm	White	28 mm x 28 mm

Cable Tie Cradles

Polyamide. Operating Temperature: -40 to 85°C.



Part No.	Qty	Max Tie Width	Colour	Screw Size
EMC5BK	100	5 mm	Black	M3
EMC9BK	100	9 mm	Black	M5

Cable Tie Cradles

Polyamide. Operating Temperature: -40 to 85°C.



Part No.	Qty	Max Tie Width	Colour	Screw Size
EMC5	100	5 mm	White	M3
EMC9	100	9 mm	White	M5

Assorted Box of Cable Tie Bases & Cradle Mounts

Bases: Self adhesive with 2 screw holes.
Cradle Mounts: Polyamide.
Operating Temperature: -40 to 85°C.



Part No.	Box of
AB178N	120 Pieces

4 x Cradle Mounts; Sizes (Colour): 5, 9 mm (Black), 5, 9 mm (White)
4 x Cable Tie Bases, Sizes (Colour): 3.5, 4.8 mm (Black), 3.5, 4.8 mm (White)

Cable Clips - Plastic

Self-adhesive.



Part No.	Pack of	For Ø Up To	Colour	Base Size
EAC1	50	5 mm	White	19 mm x 19 mm
EAC2	50	8 mm	White	25 mm x 25 mm
EAC3	50	14 mm	White	33 mm x 28 mm

Assorted Pack of Cable Clips - Plastic

Self-adhesive.



Part No.	Pack of
AP5	50 Pieces

3 x Sizes (for Ø Up To): 5, 8 and 14 mm.



JCS Rubber Lined P-Clips

Hole Dia 6 mm. Mild steel, zinc plated.
EPDM rubber lined to prevent chafing caused by vibration.

Part No.	Pack of	Size
EAC105	50	5 mm
EAC106	50	6 mm
EAC108	50	8 mm
EAC110	50	10 mm
EAC113	50	13 mm
EAC116	50	16 mm
EAC121	50	21 mm
EAC125	50	25 mm
EAC129	50	29 mm
EAC135	50	35 mm
EAC138	50	38 mm
EAC144	25	44 mm
EAC148	25	48 mm
EAC152	25	52 mm
EAC160	25	60 mm

Assorted Pack of JCS Rubber Lined P-Clips

Part No.	Pack of
EAC100	60 Pieces

5 x Sizes: 6, 21, 29, 35 mm. 10 x Sizes: 8, 10, 13, 16 mm.



P-Clips

Nylon. Black.



Part No.	Pack of	For Cable Ø
EAC405	100	4.8 mm
EAC406	100	6.0 mm
EAC409	100	9.0 mm
EAC412	100	12.0 mm
EAC419	50	19.1 mm

Assorted Box of P-Clips

Nylon. Black.



Part No.	Box of
AB193	160 Pieces

5 x Sizes (for Cable Ø): 4.8, 6.0, 9.0, 12.0, 19.1 mm.



Cable Clips - Metal

Permanent self-adhesive.
Galvanised mild steel, white acrylic coated.

Part No.	Pack of	Size	for Cable Ø
EAC26	100	Medium	8 mm
EAC27	25	Large	12 mm

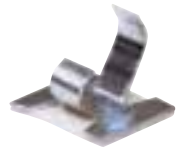

Cable Clips - Metal

Self-adhesive.

Part No.	Pack of	Diameter
EAC6	50	9.5 mm



Chassis Clips - Steel

Part No.	Pack of	Cable Grip	Length
EAC13	50	6 mm	40 mm



Cable Gland - Metric

DIN EN 50262/VDE 0619.
Body material Polyamide 6 with neoprene seal. IP68 rating.
Temp range: -30°C to 80°C. Locking nut included.

Part No.	Qty	Size	Cable Range
ECG16	10	M16	5 - 10 mm
ECG20	10	M20	10 - 14 mm
ECG25	10	M25	13 - 18 mm
ECG32	2	M32	18 - 25 mm
ECG40	2	M40	22 - 32 mm
ECG50	1	M50	30 - 38 mm



Cable Gland - PG

DIN EN 50262/VDE 0619.
Body material Polyamide 6 with neoprene seal.
IP68 rating. Temp range: -30°C to 80°C. Locking nut included.

Part No.	Qty	Size	Cable Range
EPG13	10	PG13.5	6 - 12 mm
EPG16	10	PG16	10 - 14 mm
EPG21	5	PG21	13 - 18 mm
EPG29	2	PG29	18 - 25 mm
EPG36	1	PG36	22 - 32 mm
EPG42	1	PG42	30 - 38 mm



Conduit - Split

Nylon.

Part No.	Length	Size	I.D. x O.D.
ECS10	10 m	10 mm	6.9 x 9.9 mm
ECS11	10 m	16 mm	11.5 x 15.5 mm
ECS16	10 m	21 mm	16.5 x 20.7 mm
ECS19	10 m	24 mm	19.5 x 23.5 mm
ECS31	25 m	10 mm	6.5 x 10.0 mm
ECS33	25 m	21 mm	16.9 x 21.2 mm
ECS34	25 m	26 mm	21.3 x 25.6 mm



Conduit - Unsplit

Nylon.

Part No.	Length	Size	I.D. x O.D.
ECS41	25 m	10 mm	6.5 x 10.0 mm
ECS42	25 m	16 mm	11.8 x 16.0 mm
ECS43	25 m	21 mm	16.9 x 21.2 mm
ECS44	25 m	26 mm	21.3 x 25.6 mm



Spiral Binding - Black

Polythene.

Part No.	Length	Band Width	Range
ECS29	10 m	9 mm	9 - 65 mm





Cable Ties - Black

Standard type. Manufactured from Nylon 6.6.

Part No.	Pack of	Length x Width
ECT210	100	100 mm x 2.5 mm
ECT210/5	5 x 100	100 mm x 2.5 mm
ECT210/10	10 x 100	100 mm x 2.5 mm
ECT210/55K	550 x 100	100 mm x 2.5 mm
ECT216	100	160 mm x 2.5 mm
ECT216/5	5 x 100	160 mm x 2.5 mm
ECT216/10	10 x 100	160 mm x 2.5 mm
ECT216/40K	400 x 100	160 mm x 2.5 mm
ECT220	100	200 mm x 2.5 mm
ECT220/5	5 x 100	200 mm x 2.5 mm
ECT220/10	10 x 100	200 mm x 2.5 mm
ECT220/30K	300 x 100	200 mm x 2.5 mm



Part No.	Pack of	Length x Width
ECT314	100	140 mm x 3.6 mm
ECT314/5	5 x 100	140 mm x 3.6 mm
ECT314/10	10 x 100	140 mm x 3.6 mm
ECT314/30K	300 x 100	140 mm x 3.6 mm
ECT320	100	200 mm x 3.6 mm
ECT320/5	5 x 100	200 mm x 3.6 mm
ECT320/10	10 x 100	200 mm x 3.6 mm
ECT320/20K	200 x 100	200 mm x 3.6 mm
ECT330	100	300 mm x 3.6 mm
ECT330/5	5 x 100	300 mm x 3.6 mm
ECT330/10	10 x 100	300 mm x 3.6 mm
ECT330/17K	170 x 100	300 mm x 3.6 mm



Part No.	Pack of	Length x Width
ECT416	100	160 mm x 4.8 mm
ECT416/5	5 x 100	160 mm x 4.8 mm
ECT416/10	10 x 100	160 mm x 4.8 mm
ECT416/16K	160 x 100	160 mm x 4.8 mm
ECT420	100	200 mm x 4.8 mm
ECT420/5	5 x 100	200 mm x 4.8 mm
ECT420/10	10 x 100	200 mm x 4.8 mm
ECT420/15K	150 x 100	200 mm x 4.8 mm
ECT425	100	250 mm x 4.8 mm
ECT425/5	5 x 100	250 mm x 4.8 mm
ECT425/10	10 x 100	250 mm x 4.8 mm
ECT425/12K	120 x 100	250 mm x 4.8 mm
ECT430	100	300 mm x 4.8 mm
ECT430/5	5 x 100	300 mm x 4.8 mm
ECT430/10	10 x 100	300 mm x 4.8 mm
ECT430/11K	110 x 100	300 mm x 4.8 mm
ECT437	100	370 mm x 4.8 mm
ECT437/5	5 x 100	370 mm x 4.8 mm
ECT437/10	10 x 100	370 mm x 4.8 mm
ECT437/9K	90 x 100	370 mm x 4.8 mm
ECT439	100	390 mm x 4.8 mm
ECT439/5	5 x 100	390 mm x 4.8 mm
ECT439/10	10 x 100	390 mm x 4.8 mm
ECT439/85	85 x 100	390 mm x 4.8 mm
ECT443	100	430 mm x 4.8 mm
ECT443/5	5 x 100	430 mm x 4.8 mm
ECT443/10	10 x 100	430 mm x 4.8 mm
ECT443/75	75 x 100	430 mm x 4.8 mm



Part No.	Pack of	Length x Width
ECT720	100	200 mm x 7.6 mm
ECT720/5	5 x 100	200 mm x 7.6 mm
ECT720/10	10 x 100	200 mm x 7.6 mm
ECT720/7K	70 x 100	200 mm x 7.6 mm
ECT730	100	300 mm x 7.6 mm
ECT730/5	5 x 100	300 mm x 7.6 mm
ECT730/10	10 x 100	300 mm x 7.6 mm
ECT730/5K	50 x 100	300 mm x 7.6 mm
ECT737	100	370 mm x 7.6 mm
ECT737/5	5 x 100	370 mm x 7.6 mm
ECT737/10	10 x 100	370 mm x 7.6 mm
ECT737/4K	40 x 100	370 mm x 7.6 mm
ECT745	100	450 mm x 7.6 mm
ECT745/5	5 x 100	450 mm x 7.6 mm
ECT745/10	10 x 100	450 mm x 7.6 mm
ECT745/25	25 x 100	450 mm x 7.6 mm
ECT754	100	540 mm x 7.6 mm
ECT754/5	5 x 100	540 mm x 7.6 mm
ECT754/10	10 x 100	540 mm x 7.6 mm
ECT754/2K	20 x 100	540 mm x 7.6 mm



Part No.	Pack of	Length x Width
ECT943	100	430 mm x 9.0 mm
ECT943/5	5 x 100	430 mm x 9.0 mm
ECT943/10	10 x 100	430 mm x 9.0 mm
ECT943/25	25 x 100	430 mm x 9.0 mm
ECT953	100	530 mm x 9.0 mm
ECT953/5	5 x 100	530 mm x 9.0 mm
ECT953/10	10 x 100	530 mm x 9.0 mm
ECT953/2K	20 x 100	530 mm x 9.0 mm
ECT971	100	710 mm x 9.0 mm
ECT971/5	5 x 100	710 mm x 9.0 mm
ECT971/10	10 x 100	710 mm x 9.0 mm
ECT971/2K	20 x 100	710 mm x 9.0 mm
ECT978	100	780 mm x 9.0 mm
ECT978/5	5 x 100	780 mm x 9.0 mm
ECT978/10	10 x 100	780 mm x 9.0 mm
ECT978/2K	20 x 100	780 mm x 9.0 mm
ECT9102	100	1020 mm x 9.0 mm
ECT9102/5	5 x 100	1020 mm x 9.0 mm
ECT9102/1K	10 x 100	1020 mm x 9.0 mm



Part No.	Pack of	Length x Width
ECT1258	100	580 mm x 12.7 mm
ECT1258/5	5 x 100	580 mm x 12.7 mm
ECT1258/12	12 x 100	580 mm x 12.7 mm
ECT12103	100	1030 mm x 12.7 mm
ECT12103/6	6 x 100	1030 mm x 12.7 mm

Cable Ties - Natural

Standard type. Manufactured from Nylon 6.6.

Part No.	Pack of	Length x Width
ECTW210	100	100 mm x 2.5 mm
ECTW210/5	5 x 100	100 mm x 2.5 mm
ECTW210/10	10 x 100	100 mm x 2.5 mm
ECTW210/55K	550 x 100	100 mm x 2.5 mm
ECTW216	100	160 mm x 2.5 mm
ECTW216/5	5 x 100	160 mm x 2.5 mm
ECTW216/10	10 x 100	160 mm x 2.5 mm
ECTW216/40K	400 x 100	160 mm x 2.5 mm
ECTW220	100	200 mm x 2.5 mm
ECTW220/5	5 x 100	200 mm x 2.5 mm
ECTW220/10	10 x 100	200 mm x 2.5 mm
ECTW220/30K	300 x 100	200 mm x 2.5 mm

Part No.	Pack of	Length x Width
ECTW314	100	140 mm x 3.6 mm
ECTW314/5	5 x 100	140 mm x 3.6 mm
ECTW314/10	10 x 100	140 mm x 3.6 mm
ECTW314/30K	300 x 100	140 mm x 3.6 mm
ECTW320	100	200 mm x 3.6 mm
ECTW320/5	5 x 100	200 mm x 3.6 mm
ECTW320/10	10 x 100	200 mm x 3.6 mm
ECTW320/20K	200 x 100	200 mm x 3.6 mm
ECTW330	100	300 mm x 3.6 mm
ECTW330/5	5 x 100	300 mm x 3.6 mm
ECTW330/10	10 x 100	300 mm x 3.6 mm
ECTW330/17K	170 x 100	300 mm x 3.6 mm

Part No.	Pack of	Length x Width
ECTW416	100	160 mm x 4.8 mm
ECTW416/5	5 x 100	160 mm x 4.8 mm
ECTW416/10	10 x 100	160 mm x 4.8 mm
ECTW416/16K	160 x 100	160 mm x 4.8 mm
ECTW420	100	200 mm x 4.8 mm
ECTW420/5	5 x 100	200 mm x 4.8 mm
ECTW420/10	10 x 100	200 mm x 4.8 mm
ECTW420/15K	150 x 100	200 mm x 4.8 mm
ECTW425	100	250 mm x 4.8 mm
ECTW425/5	5 x 100	250 mm x 4.8 mm
ECTW425/10	10 x 100	250 mm x 4.8 mm
ECTW425/12K	120 x 100	250 mm x 4.8 mm
ECTW430	100	300 mm x 4.8 mm
ECTW430/5	5 x 100	300 mm x 4.8 mm
ECTW430/10	10 x 100	300 mm x 4.8 mm
ECTW430/11K	110 x 100	300 mm x 4.8 mm
ECTW437	100	370 mm x 4.8 mm
ECTW437/5	5 x 100	370 mm x 4.8 mm
ECTW437/10	10 x 100	370 mm x 4.8 mm
ECTW437/9K	90 x 100	370 mm x 4.8 mm
ECTW439	100	390 mm x 4.8 mm
ECTW439/5	5 x 100	390 mm x 4.8 mm
ECTW439/10	10 x 100	390 mm x 4.8 mm
ECTW439/85	85 x 100	390 mm x 4.8 mm
ECTW443	100	430 mm x 4.8 mm
ECTW443/5	5 x 100	430 mm x 4.8 mm
ECTW443/10	10 x 100	430 mm x 4.8 mm
ECTW443/75	75 x 100	430 mm x 4.8 mm

Part No.	Pack of	Length x Width
ECTW720	100	200 mm x 7.6 mm
ECTW720/5	5 x 100	200 mm x 7.6 mm
ECTW720/10	10 x 100	200 mm x 7.6 mm
ECTW720/7K	70 x 100	200 mm x 7.6 mm
ECTW730	100	300 mm x 7.6 mm
ECTW730/5	5 x 100	300 mm x 7.6 mm
ECTW730/10	10 x 100	300 mm x 7.6 mm
ECTW730/5K	50 x 100	300 mm x 7.6 mm
ECTW737	100	370 mm x 7.6 mm
ECTW737/5	5 x 100	370 mm x 7.6 mm
ECTW737/10	10 x 100	370 mm x 7.6 mm
ECTW737/4K	40 x 100	370 mm x 7.6 mm
ECTW745	100	450 mm x 7.6 mm
ECTW745/5	5 x 100	450 mm x 7.6 mm
ECTW745/10	10 x 100	450 mm x 7.6 mm
ECTW745/25	25 x 100	450 mm x 7.6 mm
ECTW754	100	540 mm x 7.6 mm
ECTW754/5	5 x 100	540 mm x 7.6 mm
ECTW754/10	10 x 100	540 mm x 7.6 mm
ECTW754/2K	20 x 100	540 mm x 7.6 mm

Part No.	Pack of	Length x Width
ECTW943	100	430 mm x 9.0 mm
ECTW943/5	5 x 100	430 mm x 9.0 mm
ECTW943/10	10 x 100	430 mm x 9.0 mm
ECTW943/25	25 x 100	430 mm x 9.0 mm
ECTW953	100	530 mm x 9.0 mm
ECTW953/5	5 x 100	530 mm x 9.0 mm
ECTW953/10	10 x 100	530 mm x 9.0 mm
ECTW953/2K	20 x 100	530 mm x 9.0 mm
ECTW971	100	710 mm x 9.0 mm
ECTW971/5	5 x 100	710 mm x 9.0 mm
ECTW971/10	10 x 100	710 mm x 9.0 mm
ECTW971/2K	20 x 100	710 mm x 9.0 mm
ECTW978	100	780 mm x 9.0 mm
ECTW978/5	5 x 100	780 mm x 9.0 mm
ECTW978/10	10 x 100	780 mm x 9.0 mm
ECTW978/2K	20 x 100	780 mm x 9.0 mm
ECTW9102	100	1020 mm x 9.0 mm
ECTW9102/5	5 x 100	1020 mm x 9.0 mm
ECTW9102/1K	10 x 100	1020 mm x 9.0 mm

Part No.	Pack of	Length x Width
ECTW1258	100	580 mm x 12.7 mm
ECTW1258/5	5 x 100	580 mm x 12.7 mm
ECTW1258/12	12 x 100	580 mm x 12.7 mm
ECTW12103	100	1030 mm x 12.7 mm
ECTW12103/6	6 x 100	1030 mm x 12.7 mm



Cable Ties - Silver/Grey

Standard type. Manufactured from Nylon 6.6.

Part No.	Pack of	Length x Width
ECTG420	100	200 mm x 4.8 mm
ECTG420/5	5 x 100	200 mm x 4.8 mm
ECTG420/10	10 x 100	200 mm x 4.8 mm
ECTG420/15K	150 x 100	200 mm x 4.8 mm
ECTG430	100	300 mm x 4.8 mm
ECTG430/5	5 x 100	300 mm x 4.8 mm
ECTG430/10	10 x 100	300 mm x 4.8 mm
ECTG430/11K	110 x 100	300 mm x 4.8 mm
ECTG437	100	370 mm x 4.8 mm
ECTG437/5	5 x 100	370 mm x 4.8 mm
ECTG437/10	10 x 100	370 mm x 4.8 mm
ECTG437/9K	90 x 100	370 mm x 4.8 mm

Cable Ties - Blue

Standard type. Manufactured from Nylon 6.6.

Part No.	Pack of	Length x Width
ECT420BU	100	200 mm x 4.8 mm
ECT420BU/5	5 x 100	200 mm x 4.8 mm
ECT420BU/10	10 x 100	200 mm x 4.8 mm
ECT420BU/15K	150 x 100	200 mm x 4.8 mm
ECT430BU	100	300 mm x 4.8 mm
ECT430BU/5	5 x 100	300 mm x 4.8 mm
ECT430BU/10	10 x 100	300 mm x 4.8 mm
ECT430BU/11K	110 x 100	300 mm x 4.8 mm
ECT437BU	100	370 mm x 4.8 mm
ECT437BU/5	5 x 100	370 mm x 4.8 mm
ECT437BU/10	10 x 100	370 mm x 4.8 mm
ECT437BU/9K	90 x 100	370 mm x 4.8 mm

Cable Ties - Red

Standard type. Manufactured from Nylon 6.6.

Part No.	Pack of	Length x Width
ECT420RE	100	200 mm x 4.8 mm
ECT420RE/5	5 x 100	200 mm x 4.8 mm
ECT420RE/10	10 x 100	200 mm x 4.8 mm
ECT420RE/15K	150 x 100	200 mm x 4.8 mm
ECT430RE	100	300 mm x 4.8 mm
ECT430RE/5	5 x 100	300 mm x 4.8 mm
ECT430RE/10	10 x 100	300 mm x 4.8 mm
ECT430RE/11K	110 x 100	300 mm x 4.8 mm
ECT437RE	100	370 mm x 4.8 mm
ECT437RE/5	5 x 100	370 mm x 4.8 mm
ECT437RE/10	10 x 100	370 mm x 4.8 mm
ECT437RE/9K	90 x 100	370 mm x 4.8 mm

Metal Cable Ties - Rollerball

Stainless Steel 316.

Part No.	Pack of	Length x Width
ECT107	50	362 x 4.6 mm
ECT108	50	521 x 4.6 mm

Cable Ties - Green

Standard type. Manufactured from Nylon 6.6.

Part No.	Pack of	Length x Width
ECT420GR	100	200 mm x 4.8 mm
ECT420GR/5	5 x 100	200 mm x 4.8 mm
ECT420GR/10	10 x 100	200 mm x 4.8 mm
ECT420GR/15K	150 x 100	200 mm x 4.8 mm
ECT430GR	100	300 mm x 4.8 mm
ECT430GR/5	5 x 100	300 mm x 4.8 mm
ECT430GR/10	10 x 100	300 mm x 4.8 mm
ECT430GR/11K	110 x 100	300 mm x 4.8 mm
ECT437GR	100	370 mm x 4.8 mm
ECT437GR/5	5 x 100	370 mm x 4.8 mm
ECT437GR/10	10 x 100	370 mm x 4.8 mm
ECT437GR/9K	90 x 100	370 mm x 4.8 mm

Cable Ties - Yellow

Standard type. Manufactured from Nylon 6.6.

Part No.	Pack of	Length x Width
ECT420YE	100	200 mm x 4.8 mm
ECT420YE/5	5 x 100	200 mm x 4.8 mm
ECT420YE/10	10 x 100	200 mm x 4.8 mm
ECT420YE/15K	150 x 100	200 mm x 4.8 mm
ECT430YE	100	300 mm x 4.8 mm
ECT430YE/5	5 x 100	300 mm x 4.8 mm
ECT430YE/10	10 x 100	300 mm x 4.8 mm
ECT430YE/11K	110 x 100	300 mm x 4.8 mm
ECT437YE	100	370 mm x 4.8 mm
ECT437YE/5	5 x 100	370 mm x 4.8 mm
ECT437YE/10	10 x 100	370 mm x 4.8 mm
ECT437YE/9K	90 x 100	370 mm x 4.8 mm



Assorted Pack of Cable Ties - Coloured

Standard type. Manufactured from Nylon 6.6.

Part No.	Pack of	Length x Width
AP41	200	200 x 4.8 mm

Colours: Red, Blue, Green, Yellow



CV Boot Metal Clamps

Stainless steel.

Part No.	Pack of	Size	Range
HCV1	20	Small	19 - 40 mm
HCV2	20	Large	50 - 110 mm

HellermannTyton

BEST
SELLER



HELLERMANN TYTON Cable Ties - Black

Standard type.

Part No.	Pack of	Length x Width	Mfr Ref.
ECT1N	100	100 x 2.5 mm	T18R
ECT5N	200	120 x 4.8 mm	LK2
ECT35	100	150 x 3.5 mm	T30R
ECT2	100	200 x 4.6 mm	T50R
ECT2D	500	200 x 4.6 mm	T50R
ECT3	100	270 x 4.8 mm	LK2A
ECT6	100	300 x 7.6 mm	T120I
ECT7	100	390 x 4.6 mm	T50L
ECT7D	500	390 x 4.6 mm	T50L
ECT4	100	390 x 7.6 mm	T120R
ECT9	100	465 x 7.6 mm	T120M
ECT8	50	540 x 13.0 mm	LK5
ECT10	50	760 x 7.6 mm	120L

HellermannTyton



HELLERMANN TYTON Metal Content Ties

Dark blue nylon. Metal content dispersed throughout the head and strap ensures identification by metal detectors and X-ray machines.

Part No.	Pack of	Length x Width
ECT38	100	150 x 3.5 mm
ECT39	100	200 x 4.6 mm
ECT40	100	390 x 4.6 mm
ECT41	100	380 x 7.6 mm

HellermannTyton



HELLERMANN TYTON Cable Ties - Mounting Head Type - Black

Part No.	Pack of	Length x Width	Mfr Ref.
ECT21	100	215 x 4.6 mm	T50MR
ECT22	100	400 x 7.6 mm	T120MR

HellermannTyton



HELLERMANN TYTON Releasable Chassis Cable Ties - Black

Serrated both sides.

- Ideal for truck frames.

Part No.	Pack of	Length x Width	Mfr Ref.
ECT26	50	300 x 6.0 mm	DE863220

HellermannTyton



HELLERMANN TYTON Cable Ties - Natural (White)

Standard type.

Part No.	Pack of	Length x Width	Mfr Ref.
ECTW1N	100	100 x 2.5 mm	T18R
ECTW35	100	150 x 3.5 mm	T30R
ECTW2	100	200 x 4.6 mm	T50R
ECTW3	100	270 x 4.8 mm	LK2A
ECTW6	100	300 x 7.6 mm	T120I
ECTW7	100	390 x 4.6 mm	T50L
ECTW4	100	390 x 7.6 mm	T120R
ECTW9	100	465 x 7.6 mm	T120M
ECTW8	50	540 x 13.0 mm	LK5

HellermannTyton



HELLERMANN TYTON Cable Ties - Releasable - Black

Part No.	Pack of	Length x Width	Mfr Ref.
ECT20	100	250 x 7.5 mm	REL250

HellermannTyton



HELLERMANN TYTON Cable Ties - Releasable - Black

Fir-tree base (Mounting Hole: 6.3 - 7.0 mm, Maximum Panel Thickness: 7.0 mm).

Part No.	Pack of	Width x Length	Mfr Ref.
ECT25	100	5.0 x 170 mm	REL30SDP6

HellermannTyton



HELLERMANN TYTON Cable Ties - Releasable - Black

Panel fixing type.

Part No.	Pack of	Width x Length	Mfr Ref.
ECT23	100	4.6 x 215 mm	RT50R/SF



White Panel Fixing Cable Ties

Part No.	Pack of	Tie W x L
FIX859	20	4.5 x 200 mm



Heavy Duty Cable Tie Tensioning Tool

Rigid metal construction. For tie widths: 2.2 - 4.8 mm. Suitable for nylon cable ties ONLY.

- Automatic cut-off action.

Part No.	Qty	Description
TL932	1	Cable Tie Tool



Crimping Pliers - Ratchet Type

For insulated terminals.

Part No.	Qty	Description
TL935	1	Ratchet Crimping Pliers



Crimping Pliers - Ratchet Type

Supplied with 2 x jaw sets for insulated and non-insulated terminals.

Part No.	Qty	Description
TL930	1	Ratchet Crimping Pliers



Supaseal Crimping Pliers - Ratchet Type

- Ergonomically designed handle for ease of use
- Ratchet ensures correct crimping pressure
- Crimp range 0.5mm - 2.0mm²

Part No.	Qty	Description
TL936	1	Ratchet Crimping Pliers



Crimping Pliers - Standard

For insulated terminals.

Part No.	Qty	Description
TL933	1	Standard Crimping Pliers



NWS Crimping Pliers - Heavy Duty

For insulated terminals.

Part No.	Qty	Description
TL934	1	Heavy Duty Crimping Pliers



Copper Tube Terminal Indent Crimping Tool

For copper tube terminals: 10 - 120 mm².

Part No.	Qty	Description
TL940	1	Indent Crimping Tool



Wire Stripper, Cutter & Crimping Tool

Part No.	Qty	Description
TL931	1	Wire Stripper, Cutter & Crimper

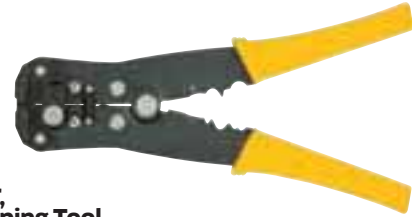

NWS Wire Stripper - Fully Insulated

For wire: 0.2 - 6.0 mm².

Adjusts automatically to diameter of wire.

- Includes side cutter.

Part No.	Qty	Description
TLA341	1	Wire Stripper



KS TOOLS Automatic Wire Strippers

Insulated handles, green for easy cable size differentiation.

Self adjusting, self closing. Adjustable length stop. Length: 170 mm.

- For stripping electrical single and multi core cable without causing damage.
- 4 Position holed blade for wire sizes: 0.5, 1.2, 1.6, 2.0 mm.

Part No.	Qty	For Cable Diameter	Handle Colour
K115.1028	1	0.5 - 2.0 mm	Green



KS TOOLS Automatic Wire Strippers

Insulated handles, red for easy cable size differentiation.

Self adjusting, self closing. Adjustable length stop. Length: 170 mm.

- For stripping electrical single and multi-core cable without causing damage.
- 5 Position holed blade for wire sizes: 1.0, 1.6, 2.0, 2.6, 3.2 mm.

Part No.	Qty	For Cable Diameter	Handle Colour
K115.1029	1	1.0 - 3.2 mm	Red





NWS Boot Lace (End-Sleeve) Terminal Crimping Pliers

Supplied complete with approx. 150 x Assortment of Boot Lace Terminals (0.5 - 2.5 mm²). DIN 46228 (Boot Lace Terminals).

Part No.	Qty	Description
TL252	1	Boot Lace Terminal Pliers



NWS 4-in-1 Electricians' VDE Pliers

Special tool steel, drop-forged, oil hardened. Matt chrome plated. 'Soft-Grip' 2 component handles with soft inlay. Optimised slip guards according to IEC 60900. 1,000V

- Cuts bolts up to M3.5, strips cable 1.5/2.5 mm², crimp and bend facility.

Part No.	Qty	Length
TNV5/190	1	190 mm



NWS Cable Cutter

Special tool steel, drop-forged, oil-hardened. Titanium finish head, soft grip 2-component handles. Spring opening.

- Adjustable screw-joint.
- For stripping and cutting copper and aluminium cable up to 25 mm Ø (70 mm²).

Part No.	Qty	Length
TNR7/210	1	210 mm (8 1/4")



NWS VDE Side Cutter

'Soft-Grip' 2-component handles. Matt chromium plated heads. Optimised slip guards according to IEC 60900. 1,000V.

Part No.	Qty	Length
TNV4/160	1	160 mm (6 1/4")



NWS Electricians' Miniature Side Cutters

Box jointed with double leaf spring. Soft wire capacity: 1.2 mm Ø.

Part No.	Qty	Length
TNE3	1	115 mm



NWS VDE Combination Pliers

'Soft-Grip' 2-component handles. Matt chromium plated heads. Optimised slip guards according to IEC 60900. 1,000V.

Part No.	Qty	Length
TNV1/180	1	180 mm (7")
TNV1/205	1	205 mm (8")



NWS VDE Long (Chain) Nose Pliers

'Soft-Grip' 2-component handles. Matt chromium plated heads. Optimised slip guards according to IEC 60900. 1,000V.

Part No.	Qty	Length
TNV2/205	1	205 mm



NWS VDE Pliers Set

Optimised slip guards according to IEC 60900. 1,000V. Induction hardened precision edges. 2-component safety grip. For hard and soft wire.

Part No.	Qty	Description
KN782	1 Set	3 Piece Set

1 x VDE Combination: 180 mm. 1 x VDE Chain Nose: 205 mm. 1 x VDE Side Cutter: 160 mm



NWS 'ErgoMulti' High Leverage VDE Combination Pliers

Insulation to IEC 60900 1,000V. Tool steel, drop-forged, oil-hardened Matt chromium plated heads. 'Soft-Grip' 2-component handles with soft inlay.

- Ergonomically angled head for strain-free working.
- Optimum power transmission from improved leverage.
- With lock and opening spring.

Part No.	Qty	Length
TNV9/200	1	200 mm (8")



NWS 'ErgoMulti' Ergonomic Electricians' Pliers

Tool steel, drop-forged, oil-hardened matt chromium plated heads. 'Soft-Grip' 2-component handles with soft inlay.

- Ergonomically angled head for strain-free working.
- Optimum power transmission from improved leverage.
- With lock and opening spring.

Part No.	Qty	Length
TNR9/200	1	200 mm (8")



NWS 'MultiCutter' 3-in-1 VDE Wire Stripping Pliers

Insulation to IEC 60900 1,000V. Matt chromium plated heads. 'Soft-Grip' 2-component handles with soft inlay.

- Precision cutting edges, induction hardened.
- V-shaped cutting edges for stripping of wires.
- Cable stripper function: Ø 8 - 13 mm.



Part No.	Qty	Length	
TNV6/180	1	180 mm	(7")



NWS 'MultiCutter' 3-in-1 Wire Stripping Pliers

Special tool steel, drop-forged, oil-hardened. Precision cutting edges, induction hardened for hard and soft wires.

- V-shaped cutting edges for stripping of wires and stranded conductors.
- Cable stripper function for all common cables from 8 - 13 mm Ø



Part No.	Qty	Length	
TNR6/180	1	180 mm	(7")



NWS 'ErgoCombi' High Leverage VDE Combination Pliers

Insulation to IEC 60900 1,000V. Tool steel, drop-forged, oil-hardened. Matt chromium plated heads. 'Soft-Grip' 2-component handles with soft inlay.

- Ergonomically angled head for strain-free working.
- Optimum power transmission from improved leverage.
- Can also be used as a spanner.



Part No.	Qty	Length	
TNV8/200	1	200 mm	(8")



NWS 'ErgoCombi' High Leverage Combination Pliers

Insulation to IEC 60900 1,000V. Tool steel, drop-forged, oil-hardened. Matt chromium plated heads. 'Soft-Grip' 2-component handles with soft inlay.

- Ergonomically angled head for strain-free working.
- Optimum power transmission from improved leverage.
- Can also be used as a spanner.



Part No.	Qty	Length	
TNR8/200	1	200 mm	(8")



NWS VDE Screwdriver - Slotted

DIN 7437 / 7348. Insulation to IEC 60900 1,000V. Black finish alloy hardened special steel blade. 2-component handle with hanging hole.



Part No.	Qty	Tip Width x Height	Shaft Length
TNS120	1	3.5 x 0.6 mm	100 mm
TNS130	1	4.0 x 0.8 mm	100 mm
TNS140	1	5.5 x 1.0 mm	125 mm
TNS150	1	6.5 x 1.2 mm	150 mm



NWS VDE Screwdriver - PH

DIN 7437 / 7348. Insulation to IEC 60900 1,000 V. Black finish alloy hardened special steel blade. 2-component handle with hanging hole.



Part No.	Qty	Tip No.	Shaft Length
TNS200	1	PH0	60 mm
TNS210	1	PH1	80 mm
TNS220	1	PH2	100 mm



NWS VDE Screwdriver - PZ

DIN 7437 / 7348. Insulation to IEC 60900 1,000 V. Black finish alloy hardened special steel blade. 2-component handle with hanging hole.



Part No.	Qty	Tip No.	Shaft Length
TNS300	1	PZ0	60 mm
TNS310	1	PZ1	80 mm
TNS320	1	PZ2	100 mm



NWS VDE Screwdriver Set - Slotted & PH

DIN 7437 / 7348. Insulation to IEC 60900 1,000 V. Black finish alloy hardened special steel blade. 2-component handle with hanging hole.



Part No.	Qty	Description
TNS500	1 Set	5 Piece Set
4 x Slotted (width x shaft length): 2.5 x 75, 4.0 x 100, 5.5 x 125, 6.5 mm.		
1 x PH Head (PH No.x shaft length): PH1 x 80 mm.		
1 x Voltage Tester, GS tested for 120-250V AC: 65 mm blade length.		



NWS VDE Screwdriver Set - Slotted & PH

DIN 7437 / 7348. Insulation to IEC 60900 1,000 V. Black finish alloy hardened special steel blade. 2-component handle with hanging hole.



Part No.	Qty	Description
TNS700	1 Set	7 Piece Set
4 x Slotted (width x shaft length): 2.5 x 75, 4.0 x 100, 5.5 x 125, 6.5 mm.		
2 x PH Head (PH No.x shaft length): PH0 x 60 mm, PH1 x 80 mm.		
1 x Voltage Tester, GS tested for 120-250V AC: 65 mm blade length.		





Actual Size
Images



BEST
SELLER



Commercial Thick Wall Auto Cable, Single - 1.00 mm²

14/0.30 mm, 8.75 amps.

Designed for commercial applications.

Part No.	Length	Colour
EC2000BK	50 m	Black
EC2000BN	50 m	Brown
EC2000BU	50 m	Blue
EC2000GR	50 m	Green
EC2000PU	50 m	Purple
EC2000RE	50 m	Red
EC2000WH	50 m	White
EC2000YE	50 m	Yellow



Thin Wall Auto Cable, Single - 1.00 mm²

32/0.20 mm, 16.5 amps. ISO 6722 : 2011 (Class B).

• Suitable for: Side/Tail Lamps, Map/Interior Lamps, Number Plate, Reversing Lamps, Stereos, Alarms, Aerials, Screen Wash Motors, Air Horns.

Part No.	Length	Colour
EC200BK	50 m	Black
EC200BN	50 m	Brown
EC200BU	50 m	Blue
EC200GR	50 m	Green
EC200PU	50 m	Purple
EC200RE	50 m	Red
EC200WH	50 m	White
EC200YE	50 m	Yellow



Commercial Thick Wall Auto Cable, Single - 2.00 mm²

28/0.30 mm, 17.5 amps.

Designed for commercial applications.

Part No.	Length	Colour
EC3000BK	50 m	Black
EC3000BN	50 m	Brown
EC3000BU	50 m	Blue
EC3000GR	50 m	Green
EC3000PU	50 m	Purple
EC3000RE	50 m	Red
EC3000WH	50 m	White
EC3000YE	50 m	Yellow



Thin Wall Auto Cable, Single - 2.00 mm²

28/0.30 mm, 25.0 amps. ISO 6722 : 2011 (Class B).

• Suitable for: Headlamps, Halogen Lamps, Fog Lamps, Spot Lamps, Cigar Lighters, Rear Screen Heaters.

Part No.	Length	Colour
EC300BK	50 m	Black
EC300BN	50 m	Brown
EC300BU	50 m	Blue
EC300GR	50 m	Green
EC300PU	50 m	Purple
EC300RE	50 m	Red
EC300WH	50 m	White
EC300YE	50 m	Yellow





Thin Wall Auto Cable, Single - 3.00 mm²

44/0.30 mm, 33.0 amps. ISO 6722 : 2011 (Class B).

• Suitable for: Ammeter Circuits, Battery Supply.

Part No.	Length	Colour
EC400BK	30 m	Black
EC400BN	30 m	Brown
EC400RE	30 m	Red



Thin Wall Auto Cable, Single - 4.50 mm²

65/0.30 mm, 42 amps. ISO 6722 : 2011 (Class B).

• Suitable for: Dynamo, Ammeter & Alternator Circuits.

Part No.	Length	Colour
EC500BK	30 m	Black
EC500BN	30 m	Brown
EC500RE	30 m	Red



Thin Wall Auto Cable, Single - 8.50 mm²

120/0.30 mm, 63 amps. ISO 6722 : 2011 (Class B).

Part No.	Length	Colour
EC600BK	30 m	Black
EC600BN	30 m	Brown
EC600RE	30 m	Red



Thin Wall Auto Cable, Flat Twin - 2 x 1.00 mm²

2 x 32/0.20 mm, 16.5 amps. ISO 6722 : 2011 (Class B). Suitable for use at temperature: 70°C.

Part No.	Length	Outer Colour
EC702	30 m	Black
EC712	100 m	Black

BEST SELLER

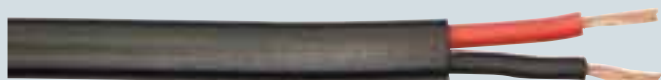

Commercial Thick Wall Auto Cable, Flat Twin - 2 x 1.00 mm²

2 x 14/0.30 mm, 8.75 amps. Designed for commercial applications.

Part No.	Length	Outer Colour
EC7020	30 m	Black
EC7120	100 m	Black



Auto Cable, 4-Core - 4 x 0.75 mm²

4 x 24/0.20 mm, 41.0 amps. ISO 6722 : 2011 (Class B).

Part No.	Length	Outer Colour
EC900	30 m	Black



Auto Cable, 5-Core - 5 x 0.75 mm²

5 x 24/0.20 mm, 14.0 amps. ISO 6722 : 2011 (Class B).

Part No.	Length	Outer Colour
EC901	30 m	Black



Auto Cable, 7-Core - 6 x 1.00 mm² & 1 x 2.00 mm²

6 x 32/0.20 mm, 16.5 amps & 1 x 28/0.30 mm, 25.0 amps. ISO 6722 : 2011 (Class B).

Part No.	Length	Outer Colour
EC903	30 m	Black



Auto Cable, 7-Core - 6 x 1.50 mm² & 1 x 2.50 mm²

6 x 21/0.30 mm, 21.0 amps & 1 x 35/0.30 mm, 29.0 amps. ISO 6722 : 2011 (Class B).

Part No.	Length	Outer Colour
EC904	30 m	Grey



Auto Cable, 7-Core - 7 x 0.75 mm²

7 x 24/0.20 mm, 14.0 amps. ISO 6722 : 2011 (Class B).

Part No.	Length	Outer Colour
EC902	30 m	Black



Thin Wall Auto Cable, Flat Twin - 2 x 2.00 mm²

2 x 28/0.30 mm, 25.0 amps. ISO 6722 : 2011 (Class B). Suitable for use at temperature: 70°C.

Part No.	Length	Outer Colour
EC703	30 m	Black
EC713	100 m	Black

BEST SELLER



Commercial Thick Wall Auto Cable, Flat Twin - 2 x 2.00 mm²

2 x 28/0.30 mm, 17.5 amps. Designed for commercial applications.

Part No.	Length	Outer Colour
EC7030	30 m	Black
EC7130	100 m	Black



Auto Cable, Stereo Twin Speaker - 2 x 0.38 mm²

2 x 12/0.20 mm, 2.00 amps.

Part No.	Length	Colour
EC1102	100 m	Black with White Stripe

Auto Cable, Stereo Twin Speaker - 2 x 0.75 mm² for Hi-Fi Systems

2 x 24/0.20 mm, 6.00 amps.

Part No.	Length	Colour
EC1104	100 m	Black with Red Stripe

Flexible Battery/Starter Cable - 25 mm²

196/0.40 mm, 170 amp.

- Suitable for use at temperatures: -15°C to 70°C.
- Resistant to petrol, lubricating oil and diluted acids.

Part No.	Length	Colour
EC801	10 m	Black
EC801RE	10 m	Red

Flexible Battery/Starter Cable - 40 mm²

315/0.40 mm, 300 amp.

- Suitable for use at temperatures: -15°C to 70°C.
- Resistant to petrol, lubricating oil and diluted acids.

Part No.	Length	Colour
EC802	10 m	Black
EC802RE	10 m	Red

Flexible Battery/Starter Cable - 60 mm²

475/0.40 mm, 415 amp.

- Suitable for use at temperatures: -15°C to 70°C.
- Resistant to petrol, lubricating oil and diluted acids.

Part No.	Length	Colour
EC803	10 m	Black
EC803RE	10 m	Red

Domestic Mains Cable 3-Core - Tough Rubber Sheath

Suitable for single phase.

Part No.	Length	Outer Colour	Size	Amps
EC1201	50 m	Black	3 x 0.75 mm ²	6A
EC1205	50 m	Black	3 x 1.00 mm ²	10A
EC1202	50 m	Black	3 x 1.50 mm ²	15A

Domestic Mains Cable 3-Core - PVC

Suitable for single phase.

Part No.	Length	Outer Colour	Size	Amps
EC1204	50 m	Black	3 x 1.50 mm ²	15A
EC1207	50 m	White	3 x 1.50 mm ²	15A
EC1211	50 m	Orange	3 x 1.50 mm ²	15A

Heavy Duty 'H07' Mains Cable 2-Core - Tough Rubber Sheath

H07RN-F BS EN 60228. Voltage rating: 450-750V. EPR: Type EM2, PCP: Tpe EM2.

- Designed to provide high flexibility and have the capacity to withstand chemical, mechanical and thermal stress.
- Suitable for handling equipment, mobile power supplies, worksites, stage and audio visual equipment, port areas and dams.
- Temperature rating: -30°C to 60°C for fixed installations.

Part No.	Qty	Outer Colour	O.D.	Amps
EC1221	50 m	Black	2 x 1.00 mm ²	10 A
EC1222	50 m	Black	2 x 1.50 mm ²	16 A
EC1223	50 m	Black	2 x 2.50 mm ²	25 A

Heavy Duty 'H07' Mains Cable 3-Core - Tough Rubber Sheath

H07RN-F BS EN 60228. Voltage rating: 450-750V. EPR: Type EM2, PCP: Tpe EM2.

- Designed to provide high flexibility and have the capacity to withstand chemical, mechanical and thermal stress.
- Suitable for handling equipment, mobile power supplies, worksites, stage and audio visual equipment, port areas and dams.
- Temperature rating: -30°C to 60°C for fixed installations.

Part No.	Qty	Outer Colour	O.D.	Amps
EC1231	50 m	Black	3 x 1.00 mm ²	10 A
EC1232	50 m	Black	3 x 1.50 mm ²	16 A
EC1233	50 m	Black	3 x 2.50 mm ²	25 A
EC1234	50 m	Black	3 x 4.00 mm ²	30 A





Cable Rack

Approx. Length: Overall 530 mm, Working 460 mm.
For cable reels with 25 mm core x 135 mm reel diameter (cable reels NOT included).

- Wall mounted or free-standing
- Retaining bar can be easily lifted off to reload
- Also takes heat shrink tubing reels
- Dispense cable without removing reels

Part No.	Qty	Description
ECR	1	Cable Rack



Surge Protector with 2 x USB Sockets

240V 2.1A. Surge protection via the 13A socket to protect any connected electronic equipment.
£ Unlimited connected equipment warranty

- 2 x USB charger outputs ideal for use with mobile devices



Part No.	Qty	Description
ERP71	1	Surge Protector

240V Cable Reels

240V 13A.
Manufactured to BS EN 6124.
Heavy duty with thermal cut-out.
Cable size: 1.25 mm² (HO5VV-F).
Maximum load: 720W fully wound,
3,120W fully unwound.
Fitted with 13A mains plug.



- 4 x Safety shutter sockets
- Strong steel stand and robust case reel
- Power on/off switch
- Power LED indicator

Part No.	Qty	Length
ERP25	1	25 m Reel
ERP50	1	50 m Reel

Cassette Cable Reel

240V 10A.
Heavy duty with thermal cut-out.
Manufactured to BS EN 61242.
Cable size: 1.25 mm².
Fitted with 13A mains plug.



- 4 x Sockets
- Sturdy construction with easy wind handle

Part No.	Qty	Length
ERP18	1	10 m Reel



Surge Protector Extension Lead with 2 x USB Sockets

240V 2.1A. Surge protection via the 13A socket to protect any connected electronic equipment.
£ Unlimited connected equipment warranty

- 2 x USB charger outputs ideal for use with mobile devices

Part No.	Qty	Type	Cable Length
ERP74	1	4-Way	2 m

RCD Safety Adaptor

240V.

Part No.	Qty	Description
ERP20	1	RCD Safety Adaptor



3-Pin Rubber Plugs

13 amp with safety sleeving.
BS 1363/A.

Part No.	Pack of	Colour
ERP51	10	White
ERP52	10	Black



Domestic Mains Fuses

BS 1362.

Part No.	Pack of	Amperage
EFD3	50	3 A
EFD5	50	5 A
EFD13	50	13 A



Trailing Sockets

Safety shutters. BS 1363/A.
Supplied without cable or plug.

Part No.	Pack of	Type	Colour
ERP54	2	Single	Black



Trailing Sockets

Safety shutters. BS 1363/A.
Supplied without cable or plug.

Part No.	Qty	Type	Colour
ERP55	1	Double	White
ERP56	1	Double	Black



Trailing Sockets

Safety shutters. BS 1363/A.
Supplied without cable or plug.

Part No.	Qty	Type	Colour
ERP57	1	4-Way	White



Lead Connectors

10A. Black. Manufactured to BS 5733.

Part No.	Pack of	Pin Type
ERP62	2	2-Pin
ERP63	2	3-Pin



Transformer Trip Switches (Circuit Breakers)

125/250VAC. 32VDC.

Part No.	Pack of	Amperage
EC50	1	5 A
EC51	1	8 A
EC52	1	10 A
EC53	1	12 A
EC54	1	15 A
EC55	1	20 A
EC56	1	25 A
EC57	1	30 A

Transformer Trip Switch (Circuit Breakers) - Weatherproof Cover

Protects switch from moisture ingress and dust. Clear silicone rubber bubble screws over push button. Complete with 'Circuit Breaker - Press To Reset' washer. (Suits Part No.'s EC50 - EC57).

Part No.	Pack of	Suits Thread
EC49	5	M11



110V Cable Reels

110V 16A. Manufactured to BS EN 61242 & BS EN 60309. Heavy duty with thermal cut-out. Cable size: 1.50 mm² 16A yellow cable.

- Two panel sockets
- Strong steel stand and robust case reel
- Power neon indicator

Part No.	Qty	Length
ERP125	1	25 m Reel
ERP150	1	50 m Reel



110V Plugs - Yellow

IP44. 100-130V.

Part No.	Pack of	Amps
ERP68A	1	16 A
ERP68	5	16 A
ERP80	1	32 A



110V Couplers - Yellow

IP44. 100-130V.

Part No.	Pack of	Amps
ERP69A	1	16A
ERP69	5	16A
ERP81	1	32A



110V Panel Sockets - Yellow

IP44. 100-130V.

Part No.	Pack of	Amperage	Flange Size
ERP77	1	16 A	60 mm ²
ERP76	1	16 A	75 mm ²
ERP79	1	32 A	75 mm ²



110V Angled Panel Socket - Yellow

IP44. 100-130V.

Part No.	Pack of	Amperage	Flange Size
ERP78	1	16 A	70 x 85 mm





240V Plugs - Blue

IP44. 200-250V

Part No.	Pack of	Amps
ERP83	1	16 A
ERP89	1	32 A



240V Couplers - Blue

IP44. 200-250V.

Part No.	Pack of	Amps
ERP84	1	16 A
ERP90	1	32 A



240V Panel Sockets - Blue

IP44. 200-250V

Part No.	Pack of	Amperage	Flange Size
ERP82	1	16 A	60 mm ²
ERP85	1	16 A	75 mm ²
ERP88	1	32 A	75 mm ²



240V Angled Panel Sockets - Blue

IP44. 200-250V.

Part No.	Pack of	Amperage	Flange Size
ERP86	1	16 A	70 x 85 mm



Shunt Release

230V AC. Installation on the right side of the MCB.

Part No.	Qty	Description
ERSR230	1	Shut Release



400V Couplers - Red

IP44. 380-415V (4 Pin), 230-400V (5 Pin).

Part No.	Pack of	Type	Amperage
ERP106	1	4 Pin	16 A
ERP107	1	4 Pin	32 A
ERP108	1	5 Pin	16 A
ERP109	1	5 Pin	32 A



400V Plugs - Red

IP44. 380-415V (4 Pin), 230-400V (5 Pin).

Part No.	Pack of	Type	Amperage
ERP102	1	4 Pin	16 A
ERP103	1	4 Pin	32 A
ERP104	1	5 Pin	16 A
ERP105	1	5 Pin	32 A



400V Panel Sockets

IP44. 380-415V (4 Pin), 230-400V (5 Pin).

Part No.	Pack of	Type	Amperage
ERP110	1	4 Pin	16 A
ERP111	1	4 Pin	32 A
ERP112	1	5 Pin	16 A
ERP113	1	5 Pin	32 A



Shunt Trip

230V AC. Installation on the right side of the MCB.

Part No.	Qty	Description
ERST230	1	Shunt Trip





RCD Circuit Breaker - 2 Pole

EN61008-1. AC Type. 30mA

Part No.	Qty	Amperage
ERCD253	1	25 A
ERCD243	1	40 A
ERCD633	1	63 A
ERCD413	1	100 A



Switch Disconnecter - 1 Pole

EN60947-3

Part No.	Qty	Amperage
ERSD125	1	25 A
ERSD140	1	40 A
ERSD163	1	63 A



RCD Circuit Breaker - 4 Pole

EN61008-1. AC Type. 30mA

Part No.	Qty	Amperage
ERCD425	1	25 A
ERCD443	1	40 A
ERCD463	1	63 A



Switch Disconnecter - 3 Pole

EN60947-3

Part No.	Qty	Amperage
ERSD340	1	40 A
ERSD363	1	63 A
ERSD380	1	80 A
ERSD310	1	100 A



MCB Circuit Breaker - 3 Pole

EN60898-1. C Type

Part No.	Qty	Amperage
ERCB316	1	16 A
ERCB320	1	20 A
ERCB325	1	25 A
ERCB332	1	32 A
ERCB340	1	40 A
ERCB350	1	50 A
ERCB363	1	63 A



Switch Disconnecter - 4 Pole

EN60947-3

Part No.	Qty	Amperage
ERSD410	1	100 A



MCB Circuit Breaker - 1 Pole

EN60898-1. C Type

Part No.	Qty	Amperage
ERCB116	1	16 A
ERCB120	1	20 A
ERCB125	1	25 A
ERCB132	1	32 A





NEW

RING HD 2.0" Dash Camera

Takes Micro SD Card NOT included (Part No. MEM32).

- 2.0" screen provides clear footage even when driving at night
- 1080p HD resolution
- 90° lens
- Shock sensor saves recordings when a collision is detected

Part No.	Qty	Description
ERDCP20	11	HD 2.0" Dash Camera



NEW

RING HD 2.4" Dash Camera

12/24 DC with hardwire kit and 32GB Micro SD Card included.

- 2.4" screen provides clear footage even when driving at night
- 720p HD resolution
- Adjustable 110° lens to capture a wide view of the road
- Automatically switches on and off with your engine
- Audio and loop recording
- Shock sensor saves recordings when a collision is detected
- Lockable Micro SD slot to prevent tampering
- Includes 32GB Micro SD card



Part No.	Qty	Description
ERVEP1	1	HD 2.4" Dash Camera



'Premium Brand' Micro SD Memory Card

Suitable for use in Dash Cams.

Part No.	Qty	Capacity
MEM32	1	32GB



Interior Camera For Extra Security



NEW

RING HD 2.4" Dash Camera with Cabin Camera

12/24 DC with hardwire kit and 64GB Micro SD Card included. Comes with interior cabin camera for extra security.

- 2.4" screen provides clear footage even when driving at night
- 1080p HD resolution
- Adjustable 120° lens to capture a wide view of the road
- GPS Function
- Automatically switches on and off with your engine
- Audio and loop recording
- Shock sensor saves recordings when a collision is detected
- Lockable Micro SD slot to prevent tampering
- Includes 64GB Micro SD card



Part No.	Qty	Description
ERVEP2	1	HD 2.4" Dash Camera with Cabin Camera





71



74



76



77



78



81



Light + Power



82



84



93

- 70 Head Torches
- 72 Torches
- 74 Hand Lamps
- 76 Work Lights
- 77 Work Lamps
- 78 Rotating Beacons
- 80 Light Bulbs
- 81 Heat Lamp Bulbs
- 82 NEOLUX Autobulbs
- 86 EUROLEC Autobulbs
- 90 RING Autobulbs
- 102 RING Autobulb Kits
- 103 RING Autobulb Stands
- 104 Power Inverters
- 105 Battery Chargers
- 106 Jump Leads
- 107 Jump Start Power Packs
- 108 Batteries



102



104



105



106



107



108



110



112





3 x AAA



RING Adjustable LED Head Torch

Complete with 3 x AAA batteries.

- Bright white LED providing 50 lumens light output
- Provides high beam for maximum light output, a low beam for energy saving and flashing beam for attention
- Adjustable head strap with padding for comfortable use
- 8 hours battery life (approx)
- Adjusts through 90° to focus on work area



Part No.	Qty	Description
ERT5174	1	Adjustable LED Head Torch



3 x AAA



RING High Performance LED Head Torch

Complete with 3 x AAA batteries.

- Bright white LED providing 87 lumens light output
- High and low flashing functions
- Red LED flashing mode in case of emergencies
- 8 hours battery life (approx)
- Adjusts through 45° to focus on work area



Part No.	Qty	Description
ERT5191	1	High Performance LED Head Torch



RING Motion Sensor LED Head Torch

Supplied with a micro USB charging cable.

- LED provides 110 lumens light output
- High and low settings to maintain battery power
- Adjustable head strap for comfortable use
- Operated by on/off switch or motion sensor
- 360° light rotation

Part No.	Qty	Description
ERT5210	1	Motion Sensor LED Head Torch



3 x AAA



LEDLENSER 'NEO4' 240lm LED Head Torch/Rear Red LED

IP57 rating, 7-year warranty.

Supplied with 3 x AAA Alkaline batteries.

- 240lm provides light up to 30m
- 3 x Modes: High Power (240lm), Low Power (20lm), Blink
- Runtime: 6hrs (240lm), 40hr (20lm)
- Lightweight: 100g (with batteries)



Part No.	Qty	Description
ETLNE4	1	240lm LED Head Torch/Rear Red LED



2 x AA



LEDLENSER 'H5 CORE' 350lm LED Head Torch

IP67 rating. 7-year warranty. Supplied with 2 x AA Alkaline batteries.

- 3 x modes: Boost (350lm), Standard Power (200lm), Low Power (15lm)
- Advanced Focus System™ - Flood (near), spot (distance) and any level in-between
- Directable light - Angle the light beam up or down within 160°
- 100% dust tight. Watertight in water between 15 cm and 1 m for up to 30 minutes
- Anti-microbial headstrap material - Helps inhibit the growth of harmful microorganism, can also be detached for washing
- Low Battery warning - Allows time to replace batteries before power runs out
- Transport Lock mode - Prevent battery drain if switch is depressed in transit

Part No.	Qty	Description
ETLH5	1	350lm LED Head Torch



3 x AAA



LEDLENSER 'iH5' 200Lm LED Head Torch

Supplied with 1 x AA Alkaline battery.

- 2 modes: Power (200lm), Low Power (20lm)
- Advanced Focusing System: Flood (near) - Spot (distance up to 130m)
- Weight 92g including batteries
- Directable light - angle within 60°
- IP54 rating
- Rubber coated head-strap prevents movement on helmets
- 7 year warranty



Part No.	Qty	Description
ETL1H5	1	200Lm LED Head Torch



LEDLENSER



LEDLENSER 'NEO6R'
240lm Rechargeable LED Head Torch/Rear Red LED

Supplied with 1 x rechargeable battery, USB cable and chest belt.

- 240 Lumens (high) 30m beam, 6hr run time.
- 20 Lumens (low) 10m beam, 40hr runtime
- Red safety light
- 7 year warranty

Part No.	Qty	Description
ETLNE6R	1	240lm LED Recharge Head Torch/Rear LED

LEDLENSER



LEDLENSER 'H5R CORE'
500lm Magnetic Rechargeable LED Head Torch

IP67 rating. 7-year warranty. Supplied with integrated Lithium Polymer rechargeable battery pack and magnetic contact charging cable.

- 3 x modes: Boost (500lm), Power (300lm), Low Power (15lm)
- Range up to 200 meters on Boost
- Weight: 167g including batteries
- Recharge time 3.5 hours via fuss-free magnetic charging cable

Part No.	Qty	Description
ETLH5R	1	500lm LED Mag Charge Head Torch

LEDLENSER



LEDLENSER 'iH5R'
400lm LED Magnetic Rechargeable Helmet/Head Torch

IP54 water-resistance rating. 7-year warranty. Supplied with magnetic charging cable (USB) pouch and helmet mounting kit.

- 2 x modes Power (400lm / 4hrs run time), Low Power (20lm / 35hrs run time)
- Hands-free, compact head torch for everyday use
- Advanced Focus System™ - Flood (near), spot (distance) and any level in-between
- 60° Tilttable Head
- Non-slip rubber lining on headband with helmet mounting kit
- Metal clip provides alternative attachment options

Part No.	Qty	Description
ETL1H5R	1	400lm LED Mag Charge Helmet/Head Torch

LEDLENSER



LEDLENSER 'H7R CORE'
1,000lm Magnetic Rechargeable LED Head Torch

IP67 rating. 7-year warranty. Supplied with a fuss-free magnetic charging cable.

- Head diameter: 41 mm
- Weight: 259 g including batteries
- 3 x modes: Boost (1,000lm), Standard Power (600lm), Low Power (15lm)
- Advanced focusing system - Flood (near), spot (distance) and any level in-between
- Transport Lock mode - Prevent battery drain if switch is depressed in transit
- Recharge time: 3.5 hours

Part No.	Qty	Description
ETLH7R	1	1,000lm LED Mag Charge Head Torch



LEDLENSER POWERCASE Powerbank & 'iH5R' Head Torch Charger Case

For safe transport/storage of head torch Part No. ERL1H5R. Supplied with USB cable and snap hook.

- Easy charging of head torch via magnetic charge system
- Power bank function provided with a capacity of 5,000mAh
- Battery charge level indicator

Part No.	Qty	Description
ETL1H5RPC	1	Powerbank & Head Torch Charger Case



COAST



COAST Rechargeable LED Penlight

Super-slim inspection torch designed to access the tightest possible areas and provide the best possible vision. USB, 230V mains and 12V/24V DC in-vehicle charging adaptors included.

- Lightweight (60 grams) and perfectly balanced for use held between thumb and forefinger for maximum extension
- Low glare inspection beam with crisp circular edges and consistent light level ideal for inspection in tight spaces
- Unique 'pro-flex' charging system, simply insert tip of torch into charger dock (no need to open or remove battery)
- Lithium-Polymer Battery for reliability and long service life
- COAST 5 year warranty

Part No.	Qty	Description
ETL10	1	LED Penlight

LEDLENSER



LEDLENSER 'P4R CORE' 200lm Rechargeable LED Penlight

IP54 rated. 7-year warranty. Supplied with rechargeable battery pack (2 x L-ion 10440) with integrated USB port, pocket clip and USB cable.

- The pen-like LED torch focusable up to 90m
- 3 x modes: High Power (200lm), Mid-Power (90lm), Low Power (15lm)
- Advanced Focus System™ - A seamless beam focusing for flood (near) or spot (distance) illumination and any level in-between
- Fully protected against solid objects and resistant to splashing water
- Aircraft grade aluminium - Provides strength, durability & corrosion resistant
- Recharges via the supplied USB cable in just 2.5 hours

Part No.	Qty	Description
ETLP4R	1	200lm LED Penlight

LEDLENSER



LEDLENSER 'P5R CORE' 500lm Magnetic Rechargeable LED Torch

IP68 rating. 7-year warranty. Magnetic charge system. Small enough to carry comfortably in a pocket.

- Beam range up to 250 meters on Boost
- Weight: 106g with rechargeable batteries
- 7 x modes: Boost (500lm), Standard Power (350lm), Mid-Power (130lm), Low Power (15lm), Blink, S.O.S & Strobe
- Exceptional protection against water and dust ingress
- Transport lock mode prevents accidental battery drain
- Recharge time: 2 hours

Part No.	Qty	Description
ETLP5R	1	500lm LED Mag Charge Torch

LEDLENSER



LEDLENSER 'P7R CORE' 1,400lm Magnetic Rechargeable LED Torch

IP68 rating. 7-year warranty. Supplied with wrist-strap and fuss-free magnetic contact charging cable.

- Flicker-free light
- Delivers a beam up to 300 meters on Boost
- Weight: 202g with rechargeable batteries
- 7 x Modes: Boost (1,400lm), Standard Power (1,000lm), Mid-Power (440lm), Low Power (15lm), Position, S.O.S & Strobe
- Transport lock mode
- Recharge time 4.5 hours

Part No.	Qty	Description
ETLP7R	1	1,400lm LED Mag Charge Torch





1 x AA



ELWIS PRO 'P60' 1W LED Aluminium Torch

- Complete with 1 x AA battery and clip.
- Bright white LED providing 70 lumens
 - Robust aluminium housing
 - Fluorescent on/off switch
 - Manual twist focus

Part No.	Qty	Description
ETL1060	1	LED Torch



3 x AAA



RING Flexible LED Pocket Lamp

Takes 3 x AAA batteries (included).

- Flexible, bright pocket inspection lamp
- Emits up to 220 lumens for bright illumination
- Includes LED torch for focused beam
- White LEDs create comfortable working light
- Magnetic base and pocket clip, for hands-free use
- 4.5-hour operating time
- Flexes and folds to position light exactly where you need it

Part No.	Qty	Description
ERIL58	1	Flexible LED Pocket Lamp



3 x AAA



RING LED Pocket Lamp

Supplied with 3 x AAA batteries.

- 170 lumen output
- Magnetic base and swivel pocket clip for hands free use
- Soft touch finish

Part No.	Qty	Description
ERIL56	1	LED Pocket Lamp

**Which Size
SUITS YOU?**



VISION



NEW

VISION Slimline COB LED Inspection Lamp

Complete with USB charging lead, wall plug and car adaptor.

- LED: 5W COB LED, 1W torch, 6000-7000K, Ra. 70
- Lumen and work time:
Switch 100% position: 500LM, approx 2.5 hrs
Switch 50% position: 250LM, approx 5.0 hrs
Switch 10% position: 50LM, approx 20 hrs
- Battery: 3.7V/2500mA Lithium battery
- Charge time: approx 5.5 hours
- Dimensions(W/D/H): 3.5 x 4.5 x 32/16.5cm
- Wet/Damp rated: IP20
- Strong magnet and hook in bottom
- Overload protection
- Product weight: 0.30kg



Part No.	Qty	Description
EHL305	1	Slimline Inspection Lamp

LUCECO

NEW



LUCECO 10W Multi Position COB LED Inspection Lamp

Supplied with mains adaptor lead and 12V in car charger.

- Utility lamp with versatile design
- ideal for automotive under bonnet and for professional trade use
- Dual 180° ratcheting and 360° twist function to direct light exactly where you need it
- Dual hanging hooks and strong magnetic bases for hands free use
- Up to 1000 lumen light output
- Up to 2.5 hour operating time



Part No.	Qty	Description
EHL100	1	Multi Position Inspection Lamp

VISION



VISION Flexible Magnetic Hand Lamp/Torch

230V mains and 12V DC in-vehicle charging adaptors included.

- 6 x 0.5W High Power SMD LED Lamp: 300 Lumens
- Run time 3.5 hours
- 1 x 1W LED Torch
- 2 x Rear Magnets & Flexible Magnetic Base



Part No.	Qty	Colour
EHL300B	1	Black/Blue
EHL300R	1	Black/Red
EHL300LR	1	Hi-Vis Orange
EHL300LY	1	Hi-Vis Yellow

ELWIS



ELWIS PRO 'D2' Magnetic Flexible High-CRI LED Hand Lamp/Torch

Complete with USB charging lead ONLY. Mains adaptor plug NOT included.

- CRI 95+ High colour rendering index - The best quality light to work with, ideal for painting and refinishing
- Directional light with 2 different light outputs (125 & 250 Lumens)
- Run time: 8 or 4 hours front / 10 hours torch
- IP54 Ingress Protection Rating
- 180° flexible function
- Magnet built into bottom and two magnets built into the back of the lamp
- Strong nylon hook at top
- Low battery warning (5 x flash 5 minutes before battery turns off)



Part No.	Qty	Description
EHL1002	1	Flexible Hand Lamp



NEW

RING 'MAGflex Pro' Fast Charge LED Hand Lamp

Dimensions (H x W x D): 50 x 40 x 205 mm. Supplied with Type-C USB cable and mains charging adaptor.

- Light Output: 500 Lumens (Main) 100 Lumens (Torch)
- Battery: 2500mAh Li-ion
- Operating Time: 3h (Main), 8h (Torch)
- Charging Time: 1h
- Rotating hanging hook and magnets for hands free operation
- Charging indicator
- Soft touch finish



Part No.	Qty	Description
ERIL4200	1	Flexible Hand Lamp



NEW

RING 'MAGflex Slim' Fast Charge LED Hand Lamp

Dimensions when folded (H x W x D): 44 x 37 x 175 mm. Supplied with Type-C USB cable and mains charging adaptor.

- Light Output: 500 Lumens (Main) 100 Lumens (Torch)
- Battery: 2500mAh Li-ion
- Operating Time: 3h (Main), 8h (Torch)
- Charging Time: 1h
- Charging indicator
- Foldable
- Soft touch finish

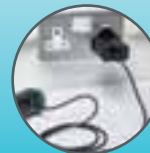

Part No.	Qty	Description
ERIL4300	1	Slimline Hand Lamp



Which Size SUITS YOU?



VISION



NEW

**VISION
Zoom Focus
LED Mini Work Light**

- 230V mains and 12V DC in-vehicle charging adaptor included.
- 20W COB LED provides 1800 Lumens
 - Dual mode - 50%/100% Lumen output
 - Run time up to 6 hours
 - USB Powerbank
 - Output socket (5V Max. 2A)
 - Wet location use IP54
 - Heavy duty cast aluminium housing
 - Battery power indicator
 - Magnetic base (available separately)

Part No.	Qty	Description
EWL100	1	Cordless 20W Work Light
EWL101	1	Magnetic Clip-on Base

RING



**RING 50w
COB LED Work Light**

- Voltage: 100-230V AC. Includes 3 m mains cable. Adjustable floor stand and carry handle.
- COB LED provides 3200 lumens of light output to illuminate work area clearly
 - Provides a pure white light that replicates natural daylight
 - Wide angle of light output that has uniform intensity for greater coverage of the work area
 - Tough robust die cast aluminium and tempered glass construction to withstand the robust working condition in a workshop
 - Construction has an Ingress Protection rating of IP65 that protects from total dust and from low pressure water jet ingress making it suitable for indoor and outdoor use
 - Cool operating temperature for comfort and safety

Part No.	Qty	Description
ERWL50	1	50W COB Work Light

LEDLENSER

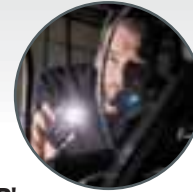

NEW

**LEDLENSER 'iF2R'
200lm Rechargeable
LED Work Light and Torch**

- IP54 rating. 7-year warranty. Provides convenient lighting for tight spaces or for illuminating small areas. Position in different ways with the base, hook and magnet. Supplied with magnetic charging cable.
- 3 modes: Power Flood (200lm), Low Power Flood (100lm) and Power Spot (75lm)
 - Perfect for workshops or sites
 - Equipped with a small spotlight to use as a torch
 - Adjustable base, magnet and hook for mounting and positioning flexibility

Part No.	Qty	Description
EHLF2R	1	200lm Rechargeable LED Work Light

LEDLENSER



NEW

**LEDLENSER 'iF3R'
1,000lm Rechargeable
LED Work Light**

- IP54 rating. 7-year warranty. Supplied with magnetic charging cable.
- 2 Modes: Power (1000lm) , Low Power (100lm)
 - Compact design: only 14 cm long
 - On the lowest setting it will run for up to 15 hours
 - Charges via magnetic charge system, so it's even waterproof when the ports aren't covered (IP54)
 - Small worklight with outstanding light output
 - Adjustable base, magnet and hook for flexible mounting and positioning

Part No.	Qty	Description
EHLF3R	1	1,000lm Rechargeable LED Work Light

RING



**RING
10W COB
LED Work Light**

- Voltage: 100-230V AC. Includes 3 m mains cable. Adjustable floor stand and carry handle.
- Provides 800 Lumens of light output
 - Wide angle, uniform intensity lighting replicating daylight
 - Tough robust design
 - Cool operating temperature

Part No.	Qty	Description
ERWL10	1	10W COB Work Light



LED Adjustable Work Lamp - 6" Rectangular

IP67, EMC approved. Housing: Aluminium. Lens: Acrylic. Stainless steel mounting bracket

- 8 x High Performance LEDs
- 24 Watt/1680 Lumens
- Can be used as standard or side mount with swivel function

Part No.	Qty	Voltage	Description	ECE Reg
EBW6	1	12-28V	6" Adjustable	-

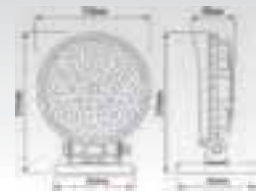

LED Magnetic Work Lamp - 4" Round

IP67, EMC approved. Housing: Aluminium. Lens: Acrylic. Supplied with 9.5M cable with switched in-vehicle adaptor.

- 6 x High Performance LEDs
- 18 Watt/1350 Lumens
- Magnetic Base
- Shock Resistant

Part No.	Qty	Voltage	Description	ECE Reg
EBW1	1	12-28V	4" Round	10



LED High Power Work Lamp - 4" Square

IP67, EMC approved. Housing: Aluminium. Lens: Acrylic. Stainless steel mounting bracket

- 16 x High Performance LEDs
- 48 Watt/3200 Lumens

Part No.	Qty	Voltage	Description	ECE Reg
EBW5	1	12-28V	4" Square	10

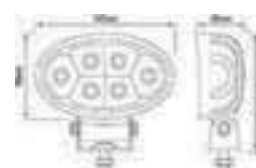

LED Work Lamp - 6" Oval

IP67, EMC approved. Housing: Aluminium. Lens: Polycarbonate. Stainless steel mounting bracket.

- 6 x High Performance LEDs
- 18 Watt/1350 Lumens

Part No.	Qty	Voltage	Description	ECE Reg
EBW3	1	12-28V	6" Oval	10



LED Work Lamp - 4" Square

IP67, EMC approved. Housing: Aluminium. Lens: Acrylic. Stainless steel mounting bracket

- 5 x High Performance LEDs
- 15 Watt/1050 Lumens

Part No.	Qty	Voltage	Description	ECE Reg
EBW2	1	12-28V	4" Square	10

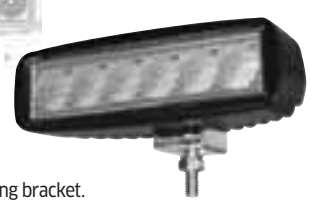

LED Work Lamp - 5" Rectangular

IP67, EMC approved. Housing: Aluminium. Lens: Polycarbonate. Stainless steel mounting bracket.

- 6 x High Performance LEDs
- 18 Watt/1350 Lumens

Part No.	Qty	Voltage	Description	ECE Reg
EBW4	1	12-28V	5" Rectangular	10

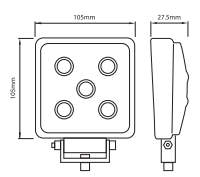

RING 15W LED Square Work Lamp - 105 mm

IP67. Certification: ECE R10. Cable length 300 mm. Housing: Thermoplastic. Lens: Polycarbonate.

- 750 Lumens
- 5 x 3W LEDs
- Lightweight

Part No.	Qty	Voltage	Description	ECE Reg
RCV9608	1	10-30V	105 mm Square	R10

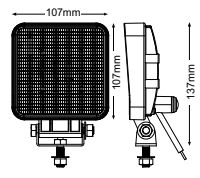

RING 15W LED Square Work Lamp with Switch

IP67. Certification: ECE R10. Cable length 300 mm. Housing: Aluminium. Lens: Polycarbonate.

- 5 x 3W LEDs
- Integrated switch
- Colour temperature: 5600K

Part No.	Qty	Voltage	Description	ECE Reg
RCV9607	1	10-30V	107 mm Square	R10





LAP ELECTRICAL Halogen Rotating Beacon - DIN Pole Mount

IP56. Robust design. Reverse polarity protection.
-30°C to + 50°C extreme temperature reliability.
Takes H1 halogen bulb (NOT included).

Part No.	Qty	Colour	Voltage	ECE Reg
EBC104	1	Amber	12/24V	R65
ERC9420	1	DIN Pole		



LAP ELECTRICAL Halogen Rotating Beacon - 3 Point

IP56. Robust design.
Reverse polarity protection.
-30°C to + 50°C extreme temperature reliability.
Takes H1 halogen bulb (NOT included).

Part No.	Qty	Colour	Voltage	ECE Reg
EBC103	1	Amber	12/24V	R65



LAP ELECTRICAL Halogen Rotating Beacon - Flexi DIN Pole Mount

IP56. Robust design. Reverse polarity protection.
-30°C to + 50°C extreme temperature reliability.
Takes H1 halogen bulb (NOT included).

Part No.	Qty	Colour	Voltage	ECE Reg
EBC105	1	Amber	12/24V	R65
ERC9420	1	DIN Pole		



LAP ELECTRICAL Halogen Rotating Beacon - Magnetic Base

IP56. Robust design. Reverse polarity protection. -30°C to + 50°C extreme temperature reliability. Takes H1 halogen bulb (NOT included).

- 70 mph rated magnet

Part No.	Qty	Colour	Voltage	ECE Reg
EBC102	1	Amber	12/24V	R65



LAP ELECTRICAL Halogen Rotating Beacon - Single Point

IP56. Robust design. Reverse polarity protection.
-30°C to + 50°C extreme temperature reliability.
Takes H1 halogen bulb (NOT included).

Part No.	Qty	Colour	Voltage	ECE Reg
EBC101	1	Amber	12/24V	R65

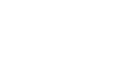

Halogen Rotating Beacon - 3 Point

EMC approved (ECE R10). Reverse polarity protection.
-15°C to +40°C extreme temperature reliability. Maintenance free worm drive mechanism. Supplied with 12V and 24V H1 halogen bulbs.

- Ideal for Refuse Trucks, Agriculture Plant & Contracting

Part No.	Qty	Colour	Voltage	ECE Reg
EBC203	1	Amber	12/24V	R65



LED



RING 'Truck Master' LED Amber Mini Bar - Magnetic Mount

60 MPH speed rating. Reg 65 compliant. IP67 rated. 20 x programmable patterns. 2.4 m cable. In-vehicle power adaptor with flash and on/off switch included. Dimensions (H x W x D): 41 x 251 x 170 mm. 3 years warranty.

Part No.	Qty	DC Voltage	Watts
ERC9822	1	9-30V	40W



LED

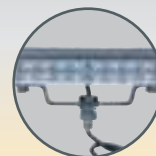

NEW



RING LED Amber Mini Lightbar Single Bolt Mount

Reg 65 compliant. IP67 rated. 40 x 1 W LED. 5 m cable. 3 years warranty.

Part No.	Qty	DC Voltage	Watts
ERC9761	1	10-30V	20W

LED



LED Rotating Beacon - Magnetic Base

IP65. EMC approved (ECE R10). Fully encapsulated electronics. 40 x LEDs. ABS base and polycarbonate lens.

- 40mph rated magnet
- 3 x Flash patterns - Simulated rotating, double flash and quad flash.

Part No.	Qty	Colour	Voltage	ECE Reg
EBC302	1	Amber	12/24V	R65

LED



LED Rotating Beacon - Flexi DIN Pole Mount

IP65. EMC approved (ECE R10). Fully encapsulated electronics. 40 x LEDs. ABS base and polycarbonate lens.

- 3 x Flash patterns - Simulated rotating, double flash and quad flash.

Part No.	Qty	Colour	Voltage	ECE Reg
EBC305	1	Amber	12/24V	R65
ERC9420	1	DIN Pole		

LED



LED Rotating Beacon - Single Point

IP65. EMC approved (ECE R10). Fully encapsulated electronics. 40 x LEDs. ABS base and polycarbonate lens.

- 3 x Flash patterns - Simulated rotating, double flash and quad flash.

Part No.	Qty	Colour	Voltage	ECE Reg
EBC301	1	Amber	12/24V	R65

LED



LED Rotating Beacon - 3 Point

IP65. EMC approved (ECE R10). Fully encapsulated electronics. 40 x LEDs. ABS base and polycarbonate lens.

- 3 x Flash patterns - Simulated rotating, double flash and quad flash.

Part No.	Qty	Colour	Voltage	ECE Reg
EBC303	1	Amber	12/24V	R65
EBC303G	1	Green	12/24V	R65



LED Interior Lamp - 18 x SMD LED 3W

Lamp material: Aluminium. Lens material: Acrylic. Supplied with stainless steel fixings

- On/Off switch

Part No.	Qty	Width x Length	12-24V	Lumens
EBL270	1	28 x 266 mm	12-24V	380

LED Interior Lamp - 45 x SMD LED 6W

Lamp material: Aluminium. Lens material: Acrylic. Supplied with stainless steel fixings

- On/Off switch

Part No.	Qty	Width x Length	Voltage	Lumens
EBL570	1	28 x 570 mm	12-24V	900

LED Interior Swivel Lamp - 6 x LED 6W

Lamp material: Aluminium. Lens material: Acrylic. Supplied with stainless steel fixings and 400 mm cable.

- On/Off switch • Lens swivels 180°

Part No.	Qty	Depth x Length	Voltage	Lumens
EBL330	1	51 x 327 mm	12-24V	600



RING 'TruckMaster' Baton LED Strip Light

Dimensions (H x W): 33 x 19 mm.

Part No.	Qty	Width	DC Voltage	Lumens
ERCV5012	1	300 mm	12/24V	400
ERCV5013	1	600 mm	12/24V	800

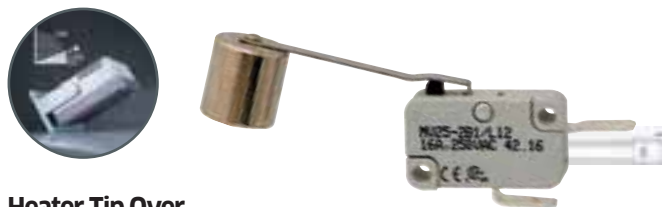

Heater Tip Over Safety Cut Out Switch

16A, 250VAC. Turns a heater off if turned over.

Part No.	Qty	Description
EC15	1	Safety Cut Out Switch



Metal-Halide Bulbs

Giant Edison screw cap (40 mm). Dia x Length: 46 x 225 mm. Provides 10,000 hours of "Day Light" (10 Years).

Part No.	Qty	Watts	Output	Cap
EMH250	1	250W	4200K	GES/E40
EMH400	1	400W	4200K	GES/E40



Metal-Halide Bulbs

Giant Edison screw cap (40 mm). Dia x Length: 76 x 335 mm. Provides 10,000 hours of "Day Light" (10 Years). Suits VT-1 type tower lights.

Part No.	Qty	Watts	Output	Cap
EMH1000	1	1000W	4200K	GES/E40



Fluorescent Hand Lamp - Replacement Tube

4 Pin type.

Part No.	Qty	Description
EHL640	1	11W Replacement Tube



Fluorescent Tube - Single

Suits BEDSONS 'Smartlamp'.

Part No.	Qty	Watts	Length
EHL55	1	8W	12"



Halogen Bulbs

Size 12 x 117 mm. Base R7S for general lighting.

Part No.	Qty	Volts	Watts
EHL30	1	240V	230W
EHL12	1	240V	400W
EHL29	1	110V	500W

LED Classic Bulbs - Edison Screw

E27 Cap. 60W equivalent. Colour Temperature: 4,000K (Daylight). NOT dimmable.

- A+ rated
- 30% energy saving of CFLs
- Double lifetime of CFLs, 15,000 hours

Part No.	Qty	Voltage	Watts
EHLED4A	1	240V	10W
EHLED4	10	240V	10W



1400w Infra-Red Heater Lamp Bulbs

R7S Push in type. For use with most common heaters. Length: 350 mm.

Part No.	Qty	Voltage
EH1	1	110V
EH2	1	240V

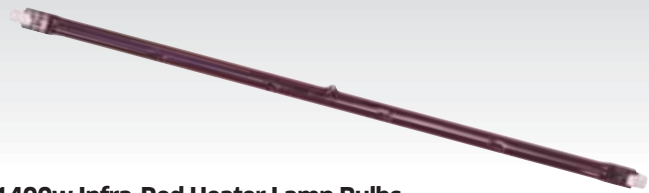

LED Classic Bulbs - Standard Bayonet Cap

B22 Cap (SBC). 60W equivalent. Colour Temperature: 4,000K (Daylight). NOT dimmable.

- A+ rated
- 30% energy saving of CFLs
- Double lifetime of CFLs, 15,000 hours

Part No.	Qty	Voltage	Watts
EHLED6A	1	240V	10W
EHLED6	10	240V	10W



1500w Infra-Red Heater Lamp Bulbs

Fly lead type with 300 mm leads. For use with most common heaters. Length: 350 mm.

Part No.	Qty	Voltage
EH3	1	110V
EH4	1	240V



RING Hand Lamp Bulbs

Pearl glass. Small bayonet cap (SBC).

Part No.	Qty	Volts	Watts
EHL805	10	12V	12W
EHL810	10	12V	24W



Ceramic Terminal Block

76A, 450V. Temperature rating: 500°C.

Part No.	Qty	Type	Cable Size
ETB50	1	2 Pole	16 mm ²



R7S Ceramic Lamp Holder

600V, 1500W, 5KV Pulse Rated. Suits Part No.s EH1 & EH2.

Part No.	Qty	Description
ETB51	1	Ceramic Lamp Holder



R7S Metal Lamp Holder

Suits Part No.s EH1 & EH2

Part No.	Qty	Description
ETB52	1	R7S Metal Lamp Holder





H1 Cap P14.5s
NEOLUX Halogen Headlamps

Part No.	Qty	Volts/Watts	E Mark	ECE No.
EB448	10	12V 55W	E	H1
EB466	10	24V 70W	E	H1



HB3 Cap P20d
NEOLUX Halogen Headlamps

Part No.	Qty	Volts/Watts	E Mark	ECE No.
EB9005	10	12V 60W	E	HB3



H3 Cap PK22s
NEOLUX Halogen Headlamps

Part No.	Qty	Volts/Watts	E Mark	ECE No.
EB453	10	12V 55W	E	H3
EB460	10	24V 70W	E	H3



HB4 Cap P22d
NEOLUX Halogen Headlamps

Part No.	Qty	Volts/Watts	E Mark	ECE No.
EB9006	10	12V 51W	E	HB4



H7 Cap Px26d
NEOLUX Halogen Headlamps

Part No.	Qty	Volts/Watts	E Mark	ECE No.
EB477	10	12V 55W	E	H7
EB474	10	24V 70W	E	H7





**H4 Cap P43t
NEOLUX Halogen Headlamps**

Part No.	Qty	Volts/Watts	E Mark	ECE No.
EB472	10	12V 60/55W	E	H4
EB475	10	24V 75/70W	E	H4

- Direct replacement for existing Gas Discharge Bulbs.
- Long life - 2500 hours.
- High luminance (nom 3200lm).
- 'E' approved.



**D2S Cap P32d-2
NEOLUX HID
Gas Discharge Bulbs**

Part No.	Qty	Volts/Watts	E Mark	ECE No.
EB85122	1	85V 35W	E	D2S



- Direct replacement for existing Gas Discharge Bulbs.
- Long life - 2500 hours.
- High luminance (nom 3200lm).
- 'E' approved.



**D1S Cap PK32d-2
NEOLUX HID
Gas Discharge Bulbs**

Part No.	Qty	Volts/Watts	E Mark	ECE No.
EB85402	1	85V 35W	E	D1S



NEOLUX®
GERMAN TECHNOLOGY

NEOLUX offer a broad range of vehicle lamps produced with high quality standards for price-conscious customers. In considering the needs of their customers, NEOLUX applies German technology standards at all stages of the supply chain. For more than 90 years, NEOLUX has been providing excellent value for money products.

NEOLUX automotive bulbs are specified in accordance with strict German quality standards and comply with ECE R37 respectively and R99 as far as relevant.

NEOLUX halogen bulbs conform to ECE R37 and ECE R99 regulations, making them approved for use across Europe and many other countries around the world which have agreed to follow UNECE 1958 agreement. Thanks to an innovative design, NEOLUX halogen bulbs surpass ECE safety regulations for UV radiation. They are suitable for the most types of headlights with glass or plastic lenses.





**P21W Cap BA15d
NEOLUX Stop, Flasher, Reverse Lamps**

SBC.

Part No.	Qty	Volts/Watts	E Mark	ECE No.
EB346	10	24V 21W	E	P21W



**P21W Cap BA15s
NEOLUX Stop, Flasher, Reverse Lamps**

SCC.

Part No.	Qty	Volts/Watts	E Mark	ECE No.
EB382	10	12V 21W	E	P21W
EB241	10	24V 21W	E	P21W



**PY21W Cap BAU15s
NEOLUX Stop, Flasher, Reverse Lamps**

Off Set Pin (SCC).

Part No.	Qty	Volts/Watts	Colour	E Mark	ECE No.
EB581	10	12V 21W	Amber	E	PY21W

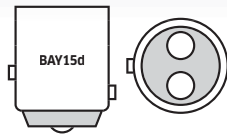

**P21/5W Cap BAY15d
NEOLUX Stop/Tail Lamps**

OSP Index (SBC).

Part No.	Qty	Volts/Watts	E Mark	ECE No.
EB380	10	12V 21/5W	E	P21/5W
EB334	10	24V 24/6W	-	-

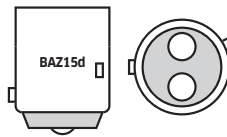

**P21/4W Cap BAZ15d
NEOLUX Fog/Tail Lamps**

SBC Index.

Part No.	Qty	Volts/Watts	E Mark	ECE No.
EB566	10	12V 21/4W	E	P21/4W



**W2.1 x 9.5d
NEOLUX Side and Tail Lamps**

Wedge Base.

Part No.	Qty	Volts/Watts	E Mark	ECE No.
EB501	10	12V 5W	E	W5W
EB501A	10	12V 5W	Amber	WY5W
EB507	10	24V 5W	E	W5W



Cap BA15s
NEOLUX Side and Tail Lamps

SCC.

Part No.	Qty	Volts/Watts	E Mark	ECE No.
EB207	10	12V 5W	E	R5W
EB245	10	12V 10W	E	R10W
EB149	10	24V 5W	E	R5W



S8.5d
NEOLUX Festoon

Part No.	Qty	Volts/Watts	Size (mm)	E Mark	ECE No.
EB239	10	12V 5W	11 x 38		C5W
EB269	10	12V 10W	11 x 30		-
EB264	10	12V 10W	11 x 44		-
EB242	10	24V 5W	11 x 38		C5W



Cap BA9s
NEOLUX Side and Tail Lamps

MCC.

Part No.	Qty	Volts/Watts	E Mark	ECE No.
EB233	10	12V 4W	E	T4W
EB249	10	24V 4W	E	T4W



W2.3W x 4.6d
NEOLUX Wedge Base Panel Lamps
Wedge Base.

Part No.	Qty	Volts/Watts	E Mark	ECE No.
EB286	10	12V 1.2W		-
EB508	10	24V 1.2W		-



R5W Cap BA15d
NEOLUX Side and Tail Lamps

SBC.

Part No.	Qty	Volts/Watts	E Mark	ECE No.
EB209	10	12V 5W	E	R5W
EB150	10	24V 5W	E	R5W





**H1 Cap P14.5s
EUROLEC Halogen Headlamps**

Part No.	Qty	Volts/Watts	E Mark	ECE No.
EUB448	10	12V 55W	E	H1
EUB466	10	24V 70W	E	H1

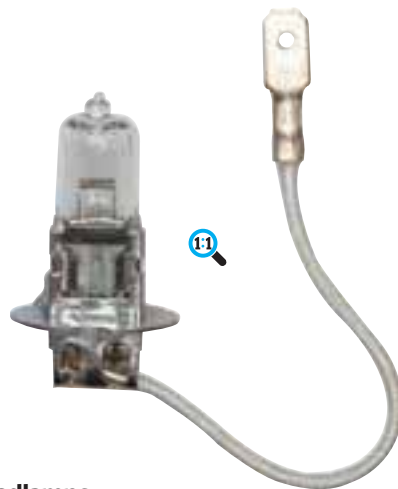

**H3 Cap PK22s
EUROLEC Halogen Headlamps**

Part No.	Qty	Volts/Watts	E Mark	ECE No.
EUB453	10	12V 55W	E	H3
EUB460	10	24V 70W	E	H3



**H7 Cap Px26d
EUROLEC Halogen Headlamps**

Part No.	Qty	Volts/Watts	E Mark	ECE No.
EUB499	10	12V 55W	E	H7
EUB474	10	24V 70W	E	H7



**HB3 Cap P20d
EUROLEC Halogen Headlamps**

Part No.	Qty	Volts/Watts	E Mark	ECE No.
EUB9005	10	12V 60W	E	HB3



**HB4 Cap P22d
EUROLEC Halogen Headlamps**

Part No.	Qty	Volts/Watts	E Mark	ECE No.
EUB9006	10	12V 51W	E	HB4





**H4 Cap P43t
EUROLEC
Halogen Headlamps**

Part No.	Qty	Volts/Watts	E Mark	ECE No.
EUB472	10	12V 60/55W	E	H4
EUB475	10	24V 75/70W	E	H4



- Direct replacement for existing Gas Discharge Bulbs.
- Long life - 2500 hours.
- High luminance (nom 3200lm).
- 'E' approved.

**D2S Cap P32d-2
EUROLEC HID
Gas Discharge Bulbs**

Part No.	Qty	Volts/Watts	E Mark	ECE No.
EUB85122	1	85V 35W	E	D2S



**D1S Cap PK32d-2
EUROLEC HID
Gas Discharge Bulbs**

Part No.	Qty	Volts/Watts	E Mark	ECE No.
EUB85402	1	85V 35W	E	D1S



- Direct replacement for existing Gas Discharge Bulbs.
- Long life - 2500 hours.
- High luminance (nom 3200lm).
- 'E' approved.

**D2R Cap P32d-3
EUROLEC HID
Gas Discharge Bulbs**

Part No.	Qty	Volts/Watts	E Mark	ECE No.
EUB85126	1	85V 35W	E	D2R



Autolamps



**P21W Cap BA15d
AUTOLAMPS
Stop, Flasher, Reverse Lamps**
SBC.

Part No.	Qty	Volts/Watts	E Mark	ECE No.
EP335	10	12V 21W	E	P21W
EP346	10	24V 21W	E	P21W

EUROLEC



**P21W Cap BA15s
EUROLEC
Stop, Flasher, Reverse Lamps**
SCC.

Part No.	Qty	Volts/Watts	E Mark	ECE No.
EU382	10	12V 21W	E	P21W
EU241	10	24V 21W	E	P21W

Autolamps



**P21W Cap BA15s
AUTOLAMPS
Stop, Flasher, Reverse Lamps**
SCC.

Part No.	Qty	Volts/Watts	E Mark	ECE No.
EP339	10	24V 24W	-	-

EUROLEC



**PY21W Cap BAU15s
EUROLEC
Stop, Flasher, Reverse Lamps**
Off Set Pin (SCC).

Part No.	Qty	Volts/Watts	Colour	E Mark	ECE No.
EU581	10	12V 21W	Amber	E	PY21W

EUROLEC



**P21/5W Cap BAY15d
EUROLEC
Stop/Tail Lamps**
OSP Index (SBC).

Part No.	Qty	Volts/Watts	E Mark	ECE No.
EU380	10	12V 21/5W	E	P21/5W
EU334	10	24V 24/6W	E	P21/5W

EUROLEC



**P21/4W Cap BAZ15d
EUROLEC
Fog/Tail Lamps**
SBC Index.

Part No.	Qty	Volts/Watts	E Mark	ECE No.
EU566	10	12V 21/4W	E	P21/4W

EUROLEC





**W2.1 x 9.5d
EUROLEC
Side and Tail Lamps**
Wedge Base.

Part No.	Qty	Volts/Watts		E Mark	ECE No.
EU501	10	12V 5W		E	W5W
EU501A	10	12V 5W	Amber	E	WY5W
EU507	10	24V 5W		E	W5W



**Cap BA15s
EUROLEC
Side and Tail Lamps**
SCC.

Part No.	Qty	Volts/Watts		E Mark	ECE No.
EU207	10	12V 5W		E	R5W
EU245	10	12V 10W		E	R10W
EU149	10	24V 5W		E	R5W



**Cap BA9s
EUROLEC
Side and Tail Lamps**
MCC.

Part No.	Qty	Volts/Watts		E Mark	ECE No.
EU233	10	12V 4W		E	T4W
EU249	10	24V 4W		E	T4W



**R5W Cap BA15d
AUTOLAMPS
Side and Tail Lamps**
SBC.

Part No.	Qty	Volts/Watts		E Mark	ECE No.
EP209	10	12V 5W		E	R5W



**R5W Cap BA15d
EUROLEC
Side and Tail Lamps**
SBC.

Part No.	Qty	Volts/Watts		E Mark	ECE No.
EU150	10	24V 5W		E	R5W



**S8.5d
EUROLEC
Festoon**

Part No.	Qty	Volts/Watts	Size (mm)	ECE No.
EU239	10	12V 5W	11 x 38	C5W
EU269	10	12V 10W	11 x 30	C10W
EU242	10	24V 5W	11 x 38	C5W



**S8.5d
AUTOLAMPS
Festoon**

Part No.	Qty	Volts/Watts	Size (mm)	ECE No.
EP269	10	12V 10W	11 x 30	-



**W2.3W x 4.6d
EUROLEC
Wedge Base Panel Lamps**
Wedge Base.

Part No.	Qty	Volts/Watts		ECE No.
EU286	10	12V 1.2W		-
EU508	10	24V 1.2W		-



**Cap B8.5D
AUTOLAMPS
Printed Circuit Board Base**

Part No.	Qty	Volts/Watts	Colour	ECE No.
EP286T	10	12V 1.2W	Black	-





BEST SELLER

H3 Cap PK22s RING Halogen Headlamps

Part No.	Qty	Volts/Watts	E Mark	ECE No.
ER453	1	12V 55W	E	H3
ER460	1	24V 70W	E	H3
ER442	1	48V 45W		(for Fork Lift Truck) -
ER443	1	80V 55W		(for Fork Lift Truck) -



BEST SELLER

H7 Cap Px26d RING Halogen Headlamps

Part No.	Qty	Volts/Watts	E Mark	ECE No.
ER477	1	12V 55W	E	H7
ER474	1	24V 70W	E	H7



**up to 150%
more light
on the road**



H7 Cap Px26d RING 'Xenon150' Halogen Headlamps

Part No.	Qty	Volts/Watts	E Mark	ECE No.
ERW1577	2	12V 55W	E	H7



**BULB
LED
UPGRADE**



H7 Cap Px26d RING Fog Light Upgrade LED Bulbs

Ice White LED fog light. HID Xenon look.

Part No.	Qty	Volts/Watts	Colour Temp	ECE No.
ERW477FLED	2	12V 2W	6000K	H7

RING 'Xenon150' Performance Bulbs

- Provides up to 150% more light on the road
- All upgrade bulbs are street legal 'E' approved
- No additional wiring or switches required
- Produces exceptional night driving performance
- Allows more time to react to potential hazards, better reflections from road markings and signs

Brightest for longest.

xenon150

The brightest, longest lasting
+150% performance halogen bulb.





BEST SELLER

H1 Cap P14.5s RING Halogen Headlamps

Part No.	Qty	Volts/Watts	E Mark	ECE No.
ER448	1	12V 55W	E	H1
ER448EQ	1	12V 55W (Spot)	E	H1
ER466	1	24V 70W	E	H1



BEST SELLER

H4 Cap P43t RING Halogen Headlamps

Part No.	Qty	Volts/Watts	E Mark	ECE No.
ER472	1	12V 60/55W	E	H4
ER473	1	12V 100/55W (for Off Road Use)	-	-
ER475	1	24V 75/70W	E	H4



H1 Cap P14.5s RING 'Xenon150' Halogen Headlamps

Part No.	Qty	Volts/Watts	E Mark	ECE No.
ERW1548	2	12V 55W	E	H1



H4 Cap P43t RING 'Xenon150' Halogen Headlamps

Part No.	Qty	Volts/Watts	E Mark	ECE No.
ERW1572	2	12V 55W	E	H4





**HB3 Cap P20d
RING Halogen Headlamps**

Part No.	Qty	Volts/Watts	E Mark	ECE No.
ER9005	1	12V 60W	E	HB3



**H8 Cap PGJ19-1
RING Halogen Headlamps**

Part No.	Qty	Volts/Watts	E Mark	ECE No.
ER708	1	12V 35W	E	H9



**HB4 Cap P22d
RING Halogen Headlamps**

Part No.	Qty	Volts/Watts	E Mark	ECE No.
ER9006	1	12V 51W	E	HB4



**H4 Halogen
Conversion Cap P45t (UEC)
RING Headlamps**

Part No.	Qty	Volts/Watts	ECE No.
ER12	1	12V 60/55W	-
ER24	1	24V 75/70W	-





**H9 Cap PGJ19-5
RING Halogen Headlamps**

Part No.	Qty	Volts/Watts	E Mark	ECE No.
ER709	1	12V 65W	E	H9



**RING Asymmetric
Headlamps - Cap P45t (UEC)**

Part No.	Qty	Volts/Watts	E Mark	ECE No.
ER410	10	12V 45/40W	E	R2
ER429	10	24V 55/50W	E	R2



**H11 Cap PGJ19-2
RING Halogen Headlamps**

Part No.	Qty	Volts/Watts	E Mark	ECE No.
ER711	1	12V 55W	E	H11



**H11 Cap PGJ19-2
RING 'Xenon150' Halogen Headlamps**

Part No.	Qty	Volts/Watts	E Mark	ECE No.
ERW1511	2	12V 55W	E	H11



Actual Size
Images



RING Standard Headlamps - Cap BA20d (Bosch Type Fitting)

Part No.	Qty	Volts/Watts	E Mark	ECE No.
ER395	1	12V 35/35W	E	S2



RING HID Gas Discharge Bulbs - D2S Cap P32d-2

Part No.	Qty	Volts/Watts	E Mark	ECE No.
ER85122	1	85V 35W	E	D2S



RING HID Gas Discharge Bulbs - D1S Cap PK32d-2

Part No.	Qty	Volts/Watts	E Mark	ECE No.
ER85402	1	85V 35W	E	D1S



RING HID Gas Discharge Bulbs - D2R Cap P32d-3

Part No.	Qty	Volts/Watts	E Mark	ECE No.
ER85126	1	85V 35W	E	D2R





RING
Stop, Flasher, Reverse Lamps
- P21W Cap BA15d

SBC.

Part No.	Qty	Volts/Watts	E Mark	ECE No.
ERB335	10 x 1	12V 21W	E	P21W
ER335	10	12V 21W	E	P21W
ERB346	10 x 1	24V 21W	E	P21W
ER346	10	24V 21W	E	P21W
ER291	10	24V 21W	E	P21W Heavy Duty



RING
Stop, Flasher, Reverse Lamps
- W21W W3 x 16d

Part No.	Qty	Volts/Watts	E Mark	ECE No.
ERB582	10 x 1	12V 21W	E	W21W
ER582	10	12V 21W	E	W21W
ERB585	10 x 1	12V 21W	E	WY21W Amber
ER585	10	12V 21W	E	WY21W Amber



RING
Stop, Flasher, Reverse Lamps
- P21W Cap BA15s

SCC.

Part No.	Qty	Volts/Watts	Colour	ECE No.
ERB343	10 x 1	12V 21W	Amber	-
ER343	10	12V 21W	Amber	-



**BEST
SELLER**

RING
Stop, Flasher, Reverse Lamps
- P21W Cap BA15s

SCC.

Part No.	Qty	Volts/Watts	E Mark	ECE No.
ERB382	10 x 1	12V 21W	E	P21W
ER382	10	12V 21W	E	P21W
ERB241	10 x 1	24V 21W	E	P21W
ER241	10	24V 21W	E	P21W
ER290	10	24V 21W	E	P21W Heavy Duty
ER339	10	24V 24W	-	-
ER345	10	28V 26W	-	- Long Life



RING LED Bulbs
Stop, Flasher, Reverse
-P21W Cap BA15s

SCC. Ice White LED light.

Illuminates quicker than a standard bulb.

Part No.	Qty	Volts/Watts	Colour Temp	ECE No.
ERW382LED	2	12V 4W	6000K	P21W
ERB2416LED	1	24V 4W	6000K	P21W



RING
Stop, Flasher, Reverse Lamps
- PY21W Cap BAU15s

Off Set Pin (SCC).

Part No.	Qty	Volts/Watts	Colour	E Mark	ECE No.
ERB581	10 x 1	12V 21W	Amber	E	PY21W
ER581	10	12V 21W	Amber	E	PY21W
ER588	10	24V 21W	Amber	E	PY21W





RING
Stop/Tail Lamps
- W21/5W W3 x 16q

Part No.	Qty	Volts/Watts	E Mark	ECE No.
ERB580	10 x 1	12V 21/5W	E	W21/5W
ER580	10	12V 21/5W	E	W21/5W



RING
Stop (High Level Brake Lamp),
Reverse Lamp - Cap W16W, W2.1x9.5d Capless

Part No.	Qty	Volts/Watts	E Mark	ECE No.
ER921	10	12V 21CP (Candle Power)	-	-
ERB955	10 x 1	12V 16W	E	W16W
ER955	10	12V 16W	E	W16W



RING
Side and Tail Lamps
- R5W Cap BA15d

Part No.	Qty	Volts/Watts	E Mark	ECE No.
ERB209	10 x 1	12V 5W	E	R5W
ER209	10	12V 5W	E	R5W
ERB150	10 x 1	24V 5W	E	R5W
ER150	10	24V 5W	E	R5W
ER247	10	24V 5W	E	R5W Heavy Duty
ER875	10	28V 7W	-	Long Life



RING
Fog/Tail Lamps
- P21/4W Cap BAZ15d
SBC Index.

Part No.	Qty	Volts/Watts	E Mark	ECE No.
ERB566	10 x 1	12V 21/4W	E	P21/4W
ER566	10	12V 21/4W	E	P21/4W
ER567	10	24V 21/4W	E	P21/4W



RING
Stop/Tail Lamps
- P21/5W Cap BAY15d
OSP Index (SBC).

Part No.	Qty	Volts/Watts	E Mark	ECE No.
ERB380	10 x 1	12V 21/5W	E	P21/5W
ER380	10	12V 21/5W	E	P21/5W
ERB294	10 x 1	24V 21/5W	E	P21/5W
ER294	10	24V 21/5W	E	P21/5W
ER334	10	24V 24/6W	-	-



RING
Stop/Tail LED Bulbs
- P21/5W Cap BAY15d

OSP Index (SBC). Ice White LED light.
Illuminates quicker than a standard bulb.

Part No.	Qty	Volts/Watts	Colour Temp	ECE No.
ERW380LED	2	12V 4W	6000K	P21/5W





RING
Stop/Tail Lamps
- Cap P27/7W W2.5x16q

Part No.	Qty	Volts/Watts	E Mark	ECE No.
ER180	10	12V 27/7W	E	P27/7W



RING
Stop/Tail Lamps
- P21/5W Cap BA15d

SBC.

Part No.	Qty	Volts/Watts	ECE No.
ER381	10	12V 21/5W	-



RING
Panel and Indicator Bulbs
- Cap G11 E10/E13

MES (Miniature Edison Screw).

Part No.	Qty	Volts/Watts	ECE No.
ER987	10	12V 2.2W	-



**BEST
SELLER**

RING
Side and Tail Lamps
- Cap BA15s

SCC.

Part No.	Qty	Volts/Watts	E Mark	ECE No.
ERB207S	10 x 1	12V 5W	E	R5W
ER207	10	12V 5W	E	R5W
ERB245S	10 x 1	12V 10W	E	R10W
ER245	10	12V 10W	E	R10W
ERB149	10 x 1	24V 5W	E	R5W
ER149	10	24V 5W	E	R5W
ER248	10	24V 5W	Heavy Duty E	R5W
ERB246	10 x 1	24V 10W	E	R10W
ER246	10	24V 10W	E	R10W
ER295	10	24V 10W	Heavy Duty E	R10W
ER874	10	28V 7W	Long Life	-



RING Side and Tail LED Bulbs
- Cap BA15s

SCC. Ice White LED Light.

Part No.	Qty	Volts/Watts	Light Temp	ECE No.
ERW207LED	2	12V 3W	6000K	R5W
ERB1496LED	1	24V 2W	6000K	R5W



**Actual Size
Images**



BEST SELLER

RING Side and Tail Lamps - W2.1 x 9.5d

Wedge Base.

Part No.	Qty	Volts/Watts	E Mark	ECE No.
ERB504	10 x 1	12V 3W	E	W3W
ER504	10	12V 3W	E	W3W
ERB501	10 x 1	12V 5W	E	W5W
ER501	10	12V 5W	E	W5W
ERB501A	10 x 1	12V 5W Amber	E	WY5W
ER501A	10	12V 5W Amber	E	WY5W
ERB505	10 x 1	24V 3W	E	W3W
ER505	10	24V 3W	E	W3W
ERB507	10 x 1	24V 5W	E	W5W
ER507	10	24V 5W	E	W5W



RING T10 Wedge LED Resistor Kit

For 501-W5W LED bulbs.

Plug and play resistor kit for vehicles with bulb failure warning system.

Part No.	Qty	Description	Volts
ELED501RES	2	LED Resistor Kit	12V



RING 'Ice White' LED Bulb - W2.1 x 9.5d

Wedge base. Filament style LED with ice white light output.

Part No.	Qty	Volts	Colour Temp	ECE No.
ERB5076FSLED	1	24V	6000K	W5W



RING 'Ice White' LED Bulb - W2.1 x 9.5d

Wedge base. Filament style LED with ice white light output.

Part No.	Qty	Volts/Watts	Colour Temp	ECE No.
ERB5076LED	1	24V 3W	6000K	W5W

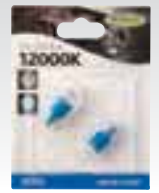

RING 'Cool Blue' LED Bulbs - W2.1 x 9.5d

Cool blue light. Wedge base.

Part No.	Qty	Volts/Watts	Light Temp	ECE No.
ERW50112LED	2	12V 1W	12000K	W5W



RING 'Cool White' LED Bulbs - W2.1 x 9.5d

Cool white light. Wedge base.

Part No.	Qty	Volts/Watts	Light Temp	ECE No.
ERW5014LED	2	12V 1W	4000K	W5W



RING 'Ice White' LED Bulbs - W2.1 x 9.5d

Ice white light. Wedge base.

Part No.	Qty	Volts/Watts	Light Temp	ECE No.
ERW5016LED	2	12V 1W	6000K	W5W



RING 'Ice White' LED Bulbs - W2.1 x 9.5d

Wedge base. Filament style LED with ice white light output.

Part No.	Qty	Volts	Colour Temp	ECE No.
ERW5016FSLED	2	12V	6000K	W5W



RING 'Ice White' LED Bulbs - W2.1 x 9.5d

Wedge base. Latest CANbus technology. No wiring changes needed - simply plug in and play.

Part No.	Qty	Volts/Watts	Colour Temp	ECE No.
ERW501CBLED	2	12V 3W	6000K	W5W





RING Side and Tail Lamps - Cap BA9s



Part No.	Qty	Volts/Watts	E Mark	ECE No.
ERB233	10 x 1	12V 4W	E	T4W
ER233	10	12V 4W	E	T4W
ERB249	10 x 1	24V 4W	E	T4W
ER249	10	24V 4W	E	T4W
ER296	10	24V 4W	E	T4W



RING 'Ice White' LED Bulbs - Cap BA9s

Filament style LED with ice white light output.

Part No.	Pack of	Volts	Light Temp	ECE No.
ERW2336FSLED	2	12V	6000K	T4W



RING Panel and Indicator Lamps - Cap BA9s

MCC.

Part No.	Qty	Volts/Watts	ECE No.
ER289	10	24V 2W	-



RING Panel and Indicator Lamps - Cap BA7s

Two Lug (Peanut Type).

Part No.	Qty	Volts/Watts	ECE No.
ER281	10	12V 2W	-
ER283	10	24V 3W	-



RING Miniature Halogen - Cap BA9s

MCC.

Part No.	Qty	Volts/Watts	E Mark	ECE No.
ER435	10	12V 21W	E	H21W
ER535	10	24V 21W	E	H21W



RING Miniature Halogen - Cap BA9s

MCC.

Part No.	Qty	Volts/Watts	E Mark	ECE No.
ER434	10	12V 6W	E	H6W



RING Miniature Halogen - Cap BA9s

MCC.

Part No.	Qty	Volts/Watts	ECE No.
ER470	10	12V 10W	-



RING Miniature Halogen - Cap G4

Part No.	Qty	Volts/Watts	ECE No.
ER570	10	12V 10W	-
ER571	10	24V 20W	-



Actual Size
Images





**RING 'Cool White'
LED Festoon Bulbs - Cap S8.5d**

Part No.	Qty	Volts/Watts	Size	Colour Temp	ECE No.
ERW2394LED	2	12V 1W	11 x 39 mm	4000K	C5W



**RING 'Ice White'
LED Festoon Bulbs - Cap S8.5d**

Part No.	Qty	Volts/Watts	Size	Colour Temp	ECE No.
ERW2396LED	2	12V 1W	11 x 39 mm	6000K	C5W



**RING 'Cool Blue'
LED Festoon Bulbs - Cap S8.5d**

Part No.	Qty	Volts/Watts	Size	Colour Temp	ECE No.
ERW23912LED	2	12V 1W	11 x 39 mm	12000K	C5W



**RING 'Ice White'
LED Festoon Bulbs - Cap S8.5d**

Latest CANbus technology. No wiring changes needed - simply plug in and play.

Part No.	Qty	Volts/Watts	Size	Colour Temp	ECE No.
ERW239CBLED	2	12V 2W	11 x 39 mm	6000K	C5W



**RING
Festoon
- Cap S8.5d**

Part No.	Qty	Volts/Watts	Size	E Mark	ECE No.
ERB272	10 x 1	12V 10W	11 x 38 mm	-	
ER272	10	12V 10W	11 x 38 mm	-	
ERB269	10 x 1	12V 10W	11 x 30 mm	-	
ER269	10	12V 10W	11 x 30 mm	-	
ERB239	10 x 1	12V 5W	11 x 30 mm	E	C5W
ER239	10	12V 5W	11 x 38 mm	E	C5W
ERB264	10 x 1	12V 10W	11 x 44 mm	-	
ER264	10	12V 10W	11 x 44 mm	-	
ERB242	10 x 1	24V 5W	11 x 38 mm	E	C5W
ER242	10	24V 5W	11 x 38 mm	E	C5W
ER260	10	24V 5W	11 x 42 mm	-	
ER274	10	24V 10W	11 x 41 mm	-	



**RING
Festoon
- Cap S8.5d**

Part No.	Qty	Volts/Watts	Size	E Mark	ECE No.
ER265	10	12V 10W	15 x 44 mm	E	-
ER273	10	12V 21W	15 x 44 mm	E	C21W



**RING Ice White'
LED Festoon Bulbs - Cap S8.5d**

Filament style LED with ice white light output.

Part No.	Qty	Volts	Size	Colour Temp	ECE No.
ERW2396FSLED	2	12V	11 x 39 mm	6000K	C5W



RING Printed Circuit Board Base - Cap B8.5D

Part No.	Qty	Volts/Watts	Base Colour	ECE No.
ER509T	10	12V 1.2W	Black	-
ERB508T	10 x 1	24V 1.2W	Grey	-
ER508T	10	24V 1.2W	Grey	-



RING Printed Circuit Board Base - Cap Kw2x4.6D

Part No.	Qty	Volts/Watts	Base Colour	ECE No.
ER508TCWH	10	24V 1.2W	White	-



RING Printed Circuit Board Base - Cap EBSR

Part No.	Qty	Volts/Watts	Base Colour	ECE No.
ER1791	10	24V 1.2W (53mA)	Yellow	-
ER1471	10	24V 1.2W (40mA)	Brown	-



RING Printed Circuit Board Base - Cap EBS N10

Part No.	Qty	Volts/Watts	Base Colour	ECE No.
ER8328	10	24V 2W	Beige	-



RING LED Blue Panel Bulb

Part No.	Qty	Volts/Milliamps	Size
ER2401LED	1	24V 20mA	36 x 14 mm



RING Wedge Base Panel Lamps - W2.3W x 4.6d

Wedge Base.

Part No.	Qty	Volts/Watts	ECE No.
ERB286	10 x 1	12V 1.2W	-
ER286	10	12V 1.2W	-
ER286B	10	12V 1.2W	Blue
ERB508	10 x 1	24V 1.2W	-
ER508	10	24V 1.2W	-



RING 12V Panel Bulb Kit

12V standard. Supplied in a handy flip-top box.

Part No.	Box of
ERPB121	71 Pieces

21 x 12V Standard Panel Bulbs: 509TMOR, 509TMBK, 509TMBE, 509TMGR, 509TMBL, 509TOR, 509T, 509TGR, 509TBBK, 509TBWH, 509TWGR, 509TWGY, 509TDBK, 509TEBK, 509THGY, 286, 286A, 286B, 286G, 286R, 501A.



RING 12V Special Panel Bulb Kit

12V special. Supplied in a handy flip-top box.

Part No.	Box of
ERPB122	69 Pieces

28 x 12V Special Bulbs: 509TMGV, 509TVI, 509TBL, 509TBE, 86021001, 86021002, 509TLBK, 509TKBK, 509TPBK, 509TWBR, 64124, 64122, 509TCTR, R509TCGY, 509TCGY/1.8, 509TCGYFR, 509TCWH, 509TFBK/12, 509TFBK/14, 509TFGY, 512TR, 512PC, 509TQWH, 509TYBK, 512WB, 509TSBK, 88005996, 509TJBR.



RING 24V Panel Bulb Kit

24V standard. Supplied in a handy flip-top box.

Part No.	Box of
ERPB243	70 Pieces

21 x 24V Bulbs: 508TMRE, 5508TMGR, 508TBR, 508T, 508TBGY, 1471, 1791, 6929, 508TWBR, 508TCWH, 508TCTR, 508A, 508B, 508G, 508R, 508TUWH, 508TVWH, 86021003, 86028166, 8328, 86024918.





RING 12V Counter Stand Bulb Rack Single Boxed Bulbs

Complete with 126 Bulbs.
Dimensions (H x W x D) 480 x 310 x 100 mm.

- Eye-catching dispenser
- Boxed and pre-merchanded with 126 bulbs
- All bulbs are 'E' marked where appropriate
- All bulbs bar-coded



Part No.	Qty	Description
ERU126	1 Set	12V Bulb Counter Stand
Stand contents:	5 x ER448	10 x ERB380
	10 x ERB382	10 x ERB2075
	10 x ERB581	10 x ERB209
	10 x ERB2455	10 x ERB501
	10 x ERB501A	10 x ERB286
	6 x ER477	



RING H4 Headlamp 12V Universal Auto Bulb Kit

Supplied in plastic storage box.

- All bulbs are 'E' marked.
- Also contains 10A blade fuses.

Part No.	Qty	Description
EBU007	1	1 Kit

Kit contains: 1 x Halogen Headlamp: ER472 (12V 60/55W).
4 x Side and Tail Lamps: ER207, ER233, ER245, ER501.
2 x Stop, Flasher, Reverse Lamps: ER382, ER581.
1 x Stop/Tail Lamp: ER380. 1 x Fog/Tail Lamp: ER566. 1 x Festoon: ER239.



RING H1, H4 & H7 Headlamp 12V Universal Auto Bulb Kit

Supplied in plastic storage box.

- All bulbs are 'E' marked.
- Also contains 10A blade fuses..

Part No.	Qty	Description
EBU027	1	1 Kit

Kit contains: 3 x Halogen Headlamps: ER477 (12V 55W), 472 (12V 55W), ER448 (12V 60/55W).
5 x Side & Tail Lamps: ER207 (x2), ER233, ER245, ER434, ER501.
3 x Stop, Flasher, Reverse Lamps: ER382, ER581, ER955.
1 x Stop/Tail Lamp: ER380. 1 x Fog/Tail Lamp: ER566. 1 x Festoon: ER239.



RING H7 Headlamp 12V Universal Auto Bulb Kit

Supplied in plastic storage box.

- All bulbs are 'E' marked.
- Also contains 10A blade fuses.

Part No.	Qty	Description
EBU077	1	1 Kit

Kit contains: 1 x Halogen Headlamp: ER477 (12V 55W).
4 x Side and Tail Lamps: ER207, ER233, ER245, ER501.
2 x Stop, Flasher, Reverse Lamps: ER382, ER581.
1 x Stop/Tail Lamp: ER380. 1 x Fog/Tail Lamp: ER566. 1 x Festoon: ER239.



RING H4 Headlamp 24V Auto Bulb Kit

Supplied in plastic storage box.

- All bulbs are 'E' marked.
- Also contains 10A blade fuses.

Part No.	Qty	Description
EBU034	1	1 Kit

Kit contains: 1 x Halogen Headlamp: ER475 (24V 75/70W).
1 x Side and Tail Lamps: ER150.
3 x Stop, Flasher, Reverse Lamps: ER346, ER588, ER241.
3 x Stop/Tail Lamp: ER507, ER249, ER149. 1 x Festoon: ER242.



RING H7 Headlamp 24V Auto Bulb Kit

Supplied in plastic storage box.

- All bulbs are 'E' marked.
- Also contains 10A blade fuses.

Part No.	Qty	Description
EBU033	1	1 Kit

Kit contains: 1 x Halogen Headlamps: ER474 (24V 70W).
1 x Side and Tail Lamps: ER150.
3 x Stop, Flasher, Reverse Lamps: ER346, ER588, ER241.
3 x Stop/Tail Lamp: ER507, ER249, ER149. 1 x Festoon: ER242.





RING 'PowerSourcePure' Modified Sine Wave 1000W Inverter

Professional 1000 watt modified sine wave inverter, converts 12 volt battery power into useful 230 volt AC mains power. Tested and certified to the relevant EMC and LVD Directives.

- Operating mode and fault indicators
- Up to 12 hours continuous use
- Compact heavy duty extruded casing
- USB charging socket for mobile devices
- Low power alarm and shut down to prevent inverter draining the battery
- Dimensions (H x W x D): 340 x 170 x 81.5 mm

Part No.	Qty	Description
ERINVMA10	1	Sine Wave Inverter 1000w



RING 'PowerSourcePure' Modified Sine Wave 2000w Inverter

Professional 2000 watt modified sine wave inverter, converts 12 volt battery power into useful 230 volt AC mains power. Tested and certified to the relevant EMC and LVD Directives.

- Operating mode and fault indicators
- Up to 12 hours continuous use
- Compact heavy duty extruded casing
- Low power alarm and shut down to prevent inverter draining the battery
- Dimensions (H x W x D): 340 x 170 x 162 mm

Part No.	Qty	Description
ERINVMA20	1	Sine Wave Inverter 2000w

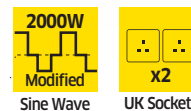

RING 'PowerSource' 12V Inverters

12V DC input modified sine wave (MSW) inverters. Supplied with battery clips for connection directly to the vehicle battery.

- Includes high power 2A USB socket suitable for recharging MP3 players, smart phones and tablets.
- Manufactured from lightweight durable ABS.

Part No.	Qty	Description
ERINVU300	1	300W Inverter
ERINVU500	1	500W Inverter

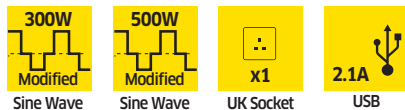

RING 'Powering' 12V Slimline Flexible 120W Inverter

Ultra slim design and flexible coiled cable allows for the inverter to be positioned in the most convenient part of any vehicle.

- Ideal for mobile phones, hand held games consoles, laptops, TVs, etc.
- Includes USB port to allow recharging of electronic devices including MP3 players.

Part No.	Qty	Description
ERINV120	1	120W Inverter





NEW

RING Smart Battery Charger 12V DC

Compatible with lead acid, gel, calcium, EFB and AGM batteries. The smart charge cycle charges the battery twice as fast as a standard car battery charger, and protects against overcharging. Slim line design makes it easy to store, while the one-button functionality makes it easy to use. The charger automatically detects the battery condition and applies the most suitable charging cycle.

- 4A smart battery charger
- Suitable for 12V vehicles
- Recommended for START/STOP vehicles
- IP65 rated: weatherproof



Part No.	Qty	Dimensions	Weight	Voltage	Amps Output
ERSC704	1	128 x 80 x 24 mm	0.506 Kg	12V	4A



NEW



RING Smart Charger and Battery Maintainer 12/24V

Compatible with lead acid, gel, calcium, EFB and AGM batteries. Keeps batteries in good condition without risk of overcharging. One button operation and large LCD backlit display for ease of use as well as reverse polarity and short-circuit protection for safety. Connect and be sure with the charger adjusting automatically to long-term maintenance mode when the vehicle's battery is full.

- For 12V and 24V vehicles
- Up to 4A or 8A charge rate
- STOP/START compatible
- Cold weather charging mode which protects batteries in cold temperatures
- One button operation for ease-of-use
- Reverse polarity and short-circuit protection

Part No.	Qty	Dimensions	Weight	Voltage	Amps Output
ERSC808	1	183 x 114 x 64 mm	0.902 Kg	12/24V	8A



12/24 Volts



RING 'SmartChargePro' 12V Battery Charger

230V AC 50Hz Input. 12V, 2-50A programmable 8 stage battery smart charger with multiple charge rate settings.

- Multi-chemistry function to set the specific charge required for different battery types.
- Power supply function maintains the battery voltage when appliances connected and drawing power.
- Includes LCD display.

Part No.	Qty	Description
ERSCPR50	1	12V Battery Charger



Booster Cables/ Jump Leads - 16 mm²

- Welding cable remains flexible even in extreme cold.
- Exceptional toughness and durability.
- Resistant to oil, Heat, abrasion, ozone and most solvents - will not sustain combustion.
- Extra Heavy Duty Clips.
- Clip insulation can be removed to provide traditional clip design.



Part No.	Qty	Length	Amp Cont.	Amp Max
BC1	1	12 ft (3.6 m)	100 A	300 A
BC3	1	16 ft (4.8 m)	110 A	300 A
BC4	1	32 ft (9.6 m)	100 A	300 A

Heavy Duty Booster Cables/ Jump Leads - 25 mm²

- Welding cable remains flexible even in extreme cold.
- Exceptional toughness and durability.
- Resistant to oil, Heat, abrasion, ozone and most solvents - will not sustain combustion.
- Extra Heavy Duty Clips.
- Clip insulation can be removed to provide traditional clip design.



Part No.	Qty	Length	Amp Cont.	Amp Max
BC5	1	16 ft (4.8 m)	170 A	450 A

Heavy Duty Booster Cables/ Jump Leads - 35 mm²

- Welding cable remains flexible even in extreme cold.
- Exceptional toughness and durability.
- Resistant to oil, Heat, abrasion, ozone and most solvents - will not sustain combustion.
- Extra Heavy Duty Clips.
- Clip insulation can be removed to provide traditional clip design.

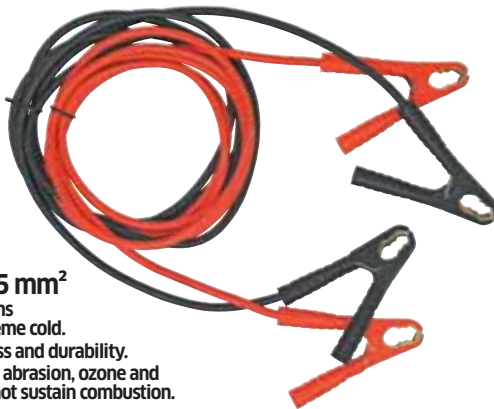

Part No.	Qty	Length	Amp Cont.	Amp Max
BC9	1	16 ft (4.8 m)	240 A	600 A

Booster Cables/ Jump Leads Clips

Extra heavy duty. Crimped.



Part No.	Qty	Colours	Amp Cont.
BC2	4 (2 x Pairs)	Red & Black	170 A



RING 'Powering' Booster Cables/Jump Leads

For LGV/Commercial Use.

- 100% multi-strand copper conductors.
- Fully insulated heavy duty clips.
- User instructions on packaging.
- Flexible PVC coating.
- Colour coded to British Standards.
- Supplied in nylon storage bag.

Part No.	Qty	Ø x Length	Amperage
BC350	1	35 mm ² x 4.5 m	450 A
BC500	1	50 mm ² x 5.0 m	600 A



RING 12V Digital Battery Analyser

Provides an accurate way to check the cranking ability and condition of 12V vehicle batteries. Microprocessor control which can analyse and test battery capacity without applying a load, providing faster more accurate results.

- LED display.
- Battery Range: 100-1700 CCA.

Part No.	Qty	Description
ERBA50	1	12V Battery Analyser



RING High Power Micro Jump Starter

A powerful, safe and compact Lithium Cobalt LiCoO₂ jump starter, ideal for small to medium cars and vans. Able to start 12V vehicles up to 3L. Also provides power to recharge electronic gadgets. Compact design fits easily into your glove box, without compromising on power.

- Powerbank function
- Fast 3hr recharge time - micro USB charging cable included
- Suitable for small to medium cars and vans up to 3L
- Intelligent clamps safely manage power between the jump starter and vehicle
- Reverse polarity, short circuit and anti-spike protection
- Includes integrated LED torch
- Rechargeable batteries included

Part No.	Qty	Dimensions	Voltage	Output
ERPPL300	1	31 x 163 x 90 mm	12V	300A

BEST SELLER



PROCELL Alkaline Batteries

Dependable power for professional devices.

Part No.	Box of	Size	Volts	Alt. Ref.'s
BAT308	10	AAA	1.5V	(LR03)



BEST SELLER



DURACELL Plus Alkaline Batteries

Part No.	Qty	Size	Volts	Alt. Ref.'s
BAT108	10 x 4	AAA	1.5V	(LR03)
BAT108A	4	AAA	1.5V	(LR03)

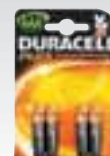

BEST SELLER



PROCELL Alkaline Batteries

Dependable power for professional devices.

Part No.	Box of	Size	Volts	Alt. Ref.'s
BAT307	10	AA	1.5V	(LR6)



BEST SELLER



DURACELL Plus Alkaline Batteries

Part No.	Qty	Size	Volts	Alt. Ref.'s
BAT107	20 x 4	AA	1.5V	(LR6)
BAT107A	4	AA	1.5V	(LR6)



PROCELL Alkaline Batteries

Dependable power for professional devices.

Part No.	Box of	Size	Volts	Alt. Ref.'s
BAT306	10	C	1.5V	(LR14)



BEST SELLER



DURACELL Plus Alkaline Batteries

Part No.	Qty	Size	Volts	Alt. Ref.'s
BAT106	10 x 2	C	1.5V	(LR14)
BAT106A	2	C	1.5V	(LR14)



PROCELL Alkaline Batteries

Dependable power for professional devices.

Part No.	Box of	Size	Volts	Alt. Ref.'s
BAT305	10	D	1.5V	(LR20)



BEST SELLER



DURACELL Plus Alkaline Batteries

Part No.	Qty	Size	Volts	Alt. Ref.'s
BAT105	10 x 2	D	1.5V	(LR20)
BAT105A	2	D	1.5V	(LR20)



BEST SELLER



PROCELL Alkaline Batteries

Dependable power for professional devices.

Part No.	Box of	Size	Volts	Alt. Ref.'s
BAT309	10	9V	9V	(PP3)



BEST SELLER



DURACELL Plus Alkaline Batteries

Part No.	Qty	Size	Volts	Alt. Ref.'s
BAT109	10 x 1	9V	9V	(PP3)
BAT109A	1	9V	9V	(PP3)



DURACELL 'Ultra' Alkaline Batteries

Part No.	Qty	Size	Volts	Alt. Ref.'s
BAT151	10 x 2	AAAA	1.5V	(25A, U2, LR8D425)
BAT151A	2	AAAA	1.5V	(25A, U2, LR8D425)



GP Batteries



GP BATTERIES 'Greencell' Heavy Duty Batteries - Zinc Chloride

Part No.	Qty	Size	Volts	Alt. Ref.'s
BAT30	10 x 4	AAA	1.5V	(HP16, R03S)



GP BATTERIES 'Greencell' Heavy Duty Batteries - Zinc Chloride

Part No.	Qty	Size	Volts	Alt. Ref.'s
BAT3	10 x 4	AA	1.5V	(HP7, R6S)



GP BATTERIES 'Greencell' Heavy Duty Batteries - Zinc Chloride

Part No.	Qty	Size	Volts	Alt. Ref.'s
BAT2	10 x 2	C	1.5V	(HP11, R14S)



GP BATTERIES 'Greencell' Heavy Duty Batteries - Zinc Chloride

Part No.	Qty	Size	Volts	Alt. Ref.'s
BAT1	10 x 2	D	1.5V	(HP2, R20S)



GP BATTERIES 'Greencell' Heavy Duty Batteries - Zinc Chloride

Part No.	Qty	Size	Volts	Alt. Ref.'s
BAT4	10 x 1	9V	9V	(PP3S, 6F22)



GP Batteries

GP BATTERIES 'Super' Alkaline Batteries

Part No.	Box of	Size	Volts	Alt. Ref.'s
BAT408A	20 x 2	AAA	1.5V	(MN2400, LR03)
BAT408	100 x 2	AAA	1.5V	(MN2400, LR03)



GP Batteries



**BEST
SELLER**

GP BATTERIES 'Ultra' Alkaline Batteries

Part No.	Box of	Size	Volts	Alt. Ref.'s
BAT8	10 x 4	AAA	1.5V	(MN2400, LR03)
BAT301	24	AAA	1.5V	(MN2400, LR03)



**BEST
SELLER**

GP BATTERIES 'Ultra' Alkaline Batteries

Part No.	Box of	Size	Volts	Alt. Ref.'s
BAT7	10 x 4	AA	1.5V	(MN1500, LR6)
BAT300	24	AA	1.5V	(MN1500, LR6)



GP BATTERIES 'Ultra' Alkaline Batteries

Part No.	Box of	Size	Volts	Alt. Ref.'s
BAT6	10 x 2	C	1.5V	(MN1400, LR14)



GP BATTERIES 'Ultra' Alkaline Batteries

Part No.	Box of	Size	Volts	Alt. Ref.'s
BAT5	10 x 2	D	1.5V	(MN1300, LR20)



GP BATTERIES 'Ultra' Alkaline Batteries

Part No.	Box of	Size	Volts	Alt. Ref.'s
BAT9	10 x 1	9V	9V	(PP3, MN1604, 6LF22, 6LR61)



GP Batteries

GP BATTERIES 'Super' Alkaline Batteries

Part No.	Box of	Size	Size	Alt. Ref.'s
BAT407A	20 x 2	AA	1.5V	(MN1500, LR6)
BAT407	100 x 2	AA	1.5V	(MN1500, LR6)



GP Batteries



GP BATTERIES 'ReCyko Pro' Rechargeable Batteries

High capacity NiMH.

Part No.	Pack of	Size	Capacity	Volts
BAT208	4	AAA	800 mAh	1.2V



GP BATTERIES 'ReCyko Pro' Rechargeable Batteries

High capacity NiMH.

Part No.	Pack of	Size	Capacity	Volts
BAT207	4	AA	2000 mAh	1.2V



GP BATTERIES 'ReCyko+' Rechargeable Batteries

High capacity NiMH.

Part No.	Pack of	Size	Capacity	Volts
BAT206	2	C	3000 mAh	1.2V



GP BATTERIES 'ReCyko+' Rechargeable Batteries

High capacity NiMH.

Part No.	Pack of	Size	Capacity	Volts
BAT205	2	D	5700 mAh	1.2V



GP BATTERIES 'ReCyko+' Rechargeable Batteries

High capacity NiMH.

Part No.	Pack of	Size	Capacity	Volts
BAT209	1	9V	200 mAh	9V



GP Batteries



GP BATTERIES Battery Charger Unit

Charges 2 or 4 x NiMH D, C, AA, AAA and 1 or 2 x 9V. 5 Hour charging (1300 mAh AA). (Batteries NOT included).

Part No.	Qty	Description
BAT84	1	NiMH Battery Charger Unit/Adaptor

GP Batteries



GP BATTERIES ReCyko USB/Mains Speed Charger with Dock

Charges 4 x AA, or 4 x AAA NiMH batteries. Provides advanced battery analytics and two charging modes (fast 1.3 hrs / eco 4 hrs). 4 x AA 2600 mAh batteries, USB charging cable and mains adaptor included.

Part No.	Qty	Description
BAT186	1	NiMH Battery Charger with Dock



**DURACELL
Hi-Speed Charger with
2 x AA & 2 x AAA 'Duralock' Batteries**

Medium Capacity NiMH: AA 1300 mAh, AAAA 750 mAh. 2 x AA ready in 45 minutes.

Part No.	Qty	Description
BAT185	1 Set	NiMH Charger + 2 x AA & 2 x AAA



**DURACELL 'Duralock'
Rechargeable Batteries**
Medium capacity NiMH.

Part No.	Pack of	Size	Capacity	Volts
BAT118	4	AAA	750 mAh	1.2V



**DURACELL 'Duralock'
Rechargeable Batteries**
Medium capacity NiMH.

Part No.	Pack of	Size	Capacity	Volts
BAT117	4	AA	1300 mAh	1.2V



DURACELL®

**DURACELL 'Ultra'
Lithium Batteries**

Part No.	Pack of	Size	Volts	Alt. Ref.'s
BAT131	2	123	3V	(CR123A, DL123, EL123AP)



**GP BATTERIES 'Super'
Alkaline Batteries**

Part No.	Box of	Size	Volts	Alt. Ref.'s
BAT51	10 x 2	AAAA	1.5V	(MN2500, 25A, U2, LR8D425)



**GP BATTERIES 'Super'
Alkaline Batteries**

For paggers

Part No.	Box of	Size	Volts	Alt. Ref.'s
BAT80	10 x 2	N	1.5V	(MN9100, LR1)



**GP BATTERIES 'Super'
Alkaline Batteries**

Used by alarm manufacturers Autoblock and Gelhard.

Part No.	Pack of	Size	Volts	Alt. Ref.'s
BAT12	10	27A	12V	(EL812, BRONICA-1)



**GP BATTERIES 'Super'
Alkaline Batteries**

Car alarm/remote: DIAHATSU, FORD, HONDA, MAZDA, MERCEDES, NISSAN, SAAB, TOYOTA, VAUXHALL, VOLVO.

Part No.	Pack of	Size	Volts	Alt. Ref.'s
BAT11	10	23A	12V	(MN21, V23GA, A23)



**GP BATTERIES
Lithium Batteries**

For use in LED Torches & Digital Cameras.

Part No.	Pack of	Size	Volts	Alt. Ref.'s
BAT13	10	CR123A	3V	(123, DL123, EL123AP)



**GP BATTERIES
Lithium Batteries**

For use in Digital Cameras.

Part No.	Pack of	Size	Volts	Alt. Ref.'s
BAT14	10	CR2	3V	(DLCR2, EL1CR2)



GP Batteries



GP BATTERIES
Button Cell Batteries
- Lithium Coins

Part No.	Pack of	Size	Volts
BAT23	10	CR1220	3V

Car alarm/remote: PEUGEOT, Used by alarm manufacturers: Meta, Moss, Phillips.

Part No.	Pack of	Size	Volts
BAT40	10	CR1616	3V

Car alarm/remote: AUDI, CITROËN, DAEWOO, PEUGEOT, NISSAN, TOYOTA.

Part No.	Pack of	Size	Volts
BAT28	10	CR1620	3V

Car alarm/remote: AUDI, CITROËN, DAEWOO, PEUGEOT, NISSAN, TOYOTA.

Part No.	Pack of	Size	Volts
BAT37	10	CR1632 *	3V

Car alarm/remote: TOYOTA, LEXUS.
* NOT branded GP BATTERIES

Part No.	Pack of	Size	Volts
BAT24	10	CR2016	3V

Car alarm/remote: BMW, CITROËN, FIAT, FORD, HONDA, LAND ROVER, PEUGEOT, RENAULT, ROVER, SAAB, SEAT, VOLVO.

Part No.	Pack of	Size	Volts
BAT25	10	CR2025	3V

Car alarm/remote: CITROËN, MERCEDES, PEUGEOT, VAUXHALL.

Part No.	Pack of	Size	Volts
BAT32	10	CR2032	3V

Car alarm/remote: CITROËN, NISSAN, ROVER.

Part No.	Pack of	Size	Volts
BAT35	10	CR2430	3V

Car alarm/remote: VOLVO, MITSUBISHI.

Part No.	Pack of	Size	Volts
BAT36	10	CR2450	3V

Car alarm/remote: BMW.

GP Batteries



GP BATTERIES
Button Cell Batteries
- Alkaline Batteries

Part No.	Pack of	Size	Volts
BAT21	10	LR44	1.5V

Car alarm/remote: CITROËN, PEUGEOT. Alt. Ref.'s (V13GA, PX76A, A76, AG13, SR44)

Part No.	Pack of	Size	Volts
BAT19	10	LR54	1.5V

Alt. Ref.'s (LR1130, AG10, GP189)

BEST SELLER



Heavy Duty Lantern Batteries
- Zinc Chloride

Part No.	Pack of	Size	Volts	Alt. Ref.'s
BAT10N	6	996	6V	(4R25, 1209)
BAT10A	1	996	6V	(4R25, 1209)

EVEREADY



EVEREADY Lantern Batteries
- Zinc Chloride

Part No.	Box of	Size	Volts	Alt. Ref.'s
BAT50	12	996	6V	(4R25, 1209)

GP Batteries

Assorted Pack of GP BATTERIES
Alkaline Batteries & Lithium Cells

Part No.	Pack of
AP177	24 Pieces

5 x Lithium Cells: CR1220, CR1616, CR2016, CR2025, CR2032.
3 x Alkaline Batteries: 23A, 27A, LR44.





114



117

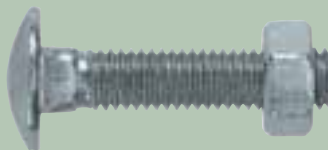

118



119



122



123



Threaded Fasteners



124



125



126

- 114 Set Screws
- 117 Bolts
- 118 Coach Bolts
- 119 Studding
- 120 Socket Screws
- 123 Machine Screws
- 124 Body Screws
- 124 Thread Repair
- 125 Threaded Inserts
- 126 Nuts
- 129 Washers
- 133 Sealing Washers
- 136 Sump Plug Washers
- 138 O-Rings

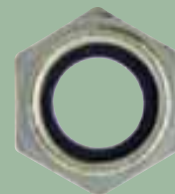

127



129



130



131



134



135



137



138





Set Screws High Tensile - Metric

Zinc plated steel. DIN 933 Grade 8.8.

Part No.	Pack of	Size x Length
HSS110	200	M4 x 10
HSS111	200	M4 x 25
HSS97	200	M5 x 12
HSS36	200	M5 x 16
HSS98	200	M5 x 20
HSS41	200	M5 x 25
HSS99	200	M5 x 30
HSS37	200	M5 x 35
HSS42	200	M5 x 40
HSS43	100	M5 x 50
HSS100	200	M6 x 12
HSS69	200	M6 x 16
HSS40	200	M6 x 20
HSS44	200	M6 x 25
HSS101	200	M6 x 30
HSS38	200	M6 x 35
HSS45	200	M6 x 40
HSS46	100	M6 x 50
HSS102	50	M6 x 60
HSS103	50	M6 x 75
HSS47	200	M7 x 25
HSS48	100	M7 x 40
HSS104	200	M8 x 16
HSS70	200	M8 x 20
HSS50	200	M8 x 25
HSS105	100	M8 x 30
HSS39	100	M8 x 35
HSS51	100	M8 x 40
HSS112	100	M8 x 45
HSS52	100	M8 x 50
HSS106	50	M8 x 60
HSS113	100	M8 x 70
HSS71	50	M8 x 75
HSS92	25	M8 x 100
HSS107	100	M10 x 20
HSS53	100	M10 x 25
HSS108	100	M10 x 30
HSS72	100	M10 x 35
HSS54	100	M10 x 40
HSS55	50	M10 x 50
HSS109	50	M10 x 60
HSS114	50	M10 x 70
HSS73	50	M10 x 75
HSS115	50	M10 x 80
HSS93	25	M10 x 100
HSS56	50	M12 x 25
HSS116	50	M12 x 35
HSS57	50	M12 x 40
HSS58	50	M12 x 50
HSS74	25	M12 x 75
HSS94	25	M12 x 100
HSS75	25	M14 x 40
HSS76	25	M14 x 50
HSS117	25	M14 x 70
HSS79	25	M14 x 75
HSS95	25	M14 x 100
HSS77	25	M16 x 50
HSS78	25	M16 x 75
HSS96	25	M16 x 100

Assorted Box of Set Screws High Tensile - Metric

Zinc plated steel. DIN 933 Grade 8.8.

Part No.	Box of
AB9N	150 Pieces
1 x M5: x 25 mm. 1 x M6: x 25 mm.	
2 x M8: x 25, 40 mm. 2 x M10: x 25, 40 mm.	



'Max Box' Assortment of Set Screws High Tensile - Metric

Zinc plated steel. DIN 933 Grade 8.8.

Part No.	Box of
AB564	290 Pieces
2 x M4: x 10, 20 mm. 3 x M5: x 10, 16, 30 mm. 5 x M6: x 10, 12, 16, 20, 30 mm. 4 x M8: x 16, 20, 30, 40 mm.	
2 x M10: x 25, 30 mm. 3 x M12: x 20, 30, 40 mm.	

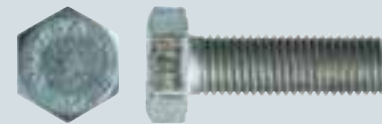

Set Screws High Tensile - Metric Fine

Zinc plated steel. DIN 961 Grade 8.8.

Part No.	Pack of	Size x Length	Pitch
HSS61	200	M5 x 25	0.50 mm
HSS62	200	M6 x 25	0.75 mm
HSS64	200	M8 x 25	1.00 mm
HSS65	200	M8 x 40	1.00 mm
HSS66	100	M10 x 40	1.25 mm
HSS60	50	M12 x 55	1.50 mm

Assorted Box of Set Screws High Tensile - Metric Fine

Zinc plated steel. DIN 961 Grade 8.8.

Part No.	Box of
AB11N	140 Pieces
1 x M5 (x 0.50 mm Pitch): x 25 mm.	
1 x M6 (x 0.75 mm Pitch): x 25 mm.	
2 x M8 (x 1.00 mm Pitch): x 25, 40 mm.	
1 x M10 (x 1.25 mm Pitch): x 40 mm.	
1 x M12 (x 1.50 mm Pitch): x 55 mm.	





Assorted Set Screws with Nuts

Zinc plated steel. DIN 933 Grade 8.8 (Set Screws High Tensile). DIN934 (Steel Nuts).

Part No.	Pack of	Size
AP64	200 Pieces	M6

3 x Lengths: 25, 40, 50 mm.

Part No.	Pack of	Size
AP65	200 Pieces	M8

3 x Lengths: 25, 40, 50 mm.

Part No.	Pack of	Size
AP67	200 Pieces	M10

3 x Lengths: 25, 40, 50 mm.

Part No.	Pack of	Size
AP68	100 Pieces	M12

3 x Lengths: 25, 40, 50 mm.

Assorted Box of M5 Fasteners

Zinc plated steel. DIN 933 Grade 8.8 (Set Screws High Tensile). DIN 934 (Steel Nuts). DIN 125 (Flat Washers).

Part No.	Box of
AB163N	550 Pieces

5 x Set Screws: M5 x 16, 20, 25, 40, 50 mm.
1 x Steel Nuts: M5. 1 x Flat Washers: M5.



Assorted Box of M6 Fasteners

Zinc plated steel. DIN 933 Grade 8.8 (Set Screws High Tensile). DIN 934 (Steel Nuts). DIN 125 (Flat Washers).

Part No.	Box of
AB128N	485 Pieces

5 x Set Screws: M6 x 16, 20, 25, 35, 50 mm.
1 x Steel Nuts: M6. 1 x Flat Washers: M6.



Assorted Box of M8 Fasteners

Zinc plated steel. DIN 933 Grade 8.8 (Set Screws High Tensile). DIN 934 (Steel Nuts). DIN 125 (Flat Washers).

Part No.	Box of
AB129N	245 Pieces

5 x Set Screws: M8 x 20, 25, 40, 50, 75 mm.
1 x Steel Nuts: M8. 1 x Flat Washers: M8.



Assorted Box of M10 Fasteners

Zinc plated steel. DIN 933 Grade 8.8 (Set Screws High Tensile). DIN 934 (Steel Nuts). DIN 125 (Flat Washers).

Part No.	Box of
AB130N	150 Pieces

4 x Set Screws: M10 x 25, 40, 50, 75 mm.
1 x Steel Nuts: M10. 1 x Flat Washers: M10.

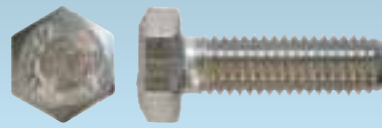

Stainless Steel Set Screws - Metric

Stainless Steel. DIN 933 Grade A2.

Part No.	Pack of	Size x Length
HIS525	100	M5 x 25
HIS625	100	M6 x 25
HIS825	100	M8 x 25
HIS840	50	M8 x 40
HIS1025	50	M10 x 25
HIS1040	50	M10 x 40

Assorted Box of Stainless Steel Set Screws - Metric

Stainless Steel. DIN 933 Grade A2.

Part No.	Box of
AB154	120 Pieces

1 x M5: x 25 mm. 1 x M6: x 25 mm. 1 x M8: x 25 mm.
1 x M8: x 40 mm. 2 x M10: x 25, 40 mm.



Plain (Black) Set Screws High Tensile - Metric

Self colour finish steel. DIN 933/BS 3692 Grade 8.8.

Part No.	Pack of	Size x Length
HSB510	200	M5 x 10
HSB670	50	M6 x 70
HSB880	25	M8 x 80
HSB1220	25	M12 x 20
HSB1265	25	M12 x 65
HSB1280	25	M12 x 80
HSB12120	25	M12 x 120
HSB1640	25	M16 x 40
HSB1660	25	M16 x 60
HSB1680	25	M16 x 80

Metric Thread Pitch Sizes

Below is a listing of the popular standard pitch sizes for all metric (coarse) threaded products.

Size	Pitch	Size	Pitch
M3	0.50 mm	M12	1.75 mm
M4	0.70 mm	M14	2.00 mm
M5	0.80 mm	M16	2.00 mm
M6	1.00 mm	M18	2.50 mm
M7	1.00 mm	M20	2.50 mm
M8	1.25 mm	M22	2.50 mm
M10	1.50 mm	M24	3.00 mm



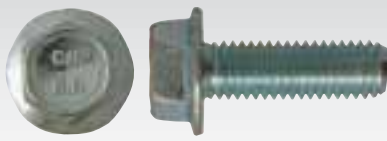

Serrated Flanged Set Screws - Metric

Zinc plated steel. DIN 6921 Grade 8.8.

Part No.	Pack of	Size x Length	Thread Type
HFL616	100	M6 x 16	Full Thread
HFL620	100	M6 x 20	Full Thread
HFL820	100	M8 x 20	Full Thread
HFL825	100	M8 x 25	Full Thread
HFL830	50	M8 x 30	Full Thread
HFL125	50	M10 x 25	Full Thread
HFL130	50	M10 x 30	Full Thread



Serrated Flanged Bolts - Metric

Zinc plated steel. DIN 6921 Grade 8.8.

Part No.	Pack of	Size x Length	Thread Type
HFL625	100	M6 x 25	Part Thread
HFL630	100	M6 x 30	Part Thread
HFL840	50	M8 x 40	Part Thread
HFL140	50	M10 x 40	Part Thread
HFL150	25	M10 x 50	Part Thread

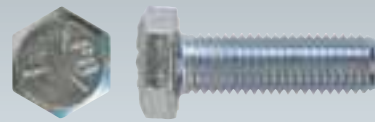

Set Screws High Tensile - UNF

Zinc plated steel. ANSI B18.2.1.1965 Grade 5.

Part No.	Pack of	Size x Length
HSS2	200	3/16" x 1"
HSS3	200	3/16" x 1 1/2"
HSS5	200	1/4" x 1/2"
HSS6	200	1/4" x 3/4"
HSS7	200	1/4" x 1"
HSS8	200	1/4" x 1 1/2"
HSS9	200	1/4" x 2"
HSS10	100	1/4" x 3"
HSS87	200	5/16" x 1/2"
HSS11	200	5/16" x 3/4"
HSS12	200	5/16" x 1"
HSS13	200	5/16" x 1 1/2"
HSS14	100	5/16" x 2"
HSS15	100	5/16" x 3"
HSS16	100	3/8" x 3/4"
HSS17	100	3/8" x 1"
HSS18	100	3/8" x 1 1/2"
HSS19	50	3/8" x 2"
HSS20	50	3/8" x 3"
HSS88	50	7/16" x 1"
HSS80	50	7/16" x 1 1/2"
HSS81	50	7/16" x 2"
HSS89	25	7/16" x 3"
HSS90	50	1/2" x 1"
HSS82	50	1/2" x 1 1/2"
HSS83	50	1/2" x 2"
HSS84	25	1/2" x 3"
HSS91	25	5/8" x 1 1/2"
HSS85	25	5/8" x 2"
HSS86	25	5/8" x 3"

Assorted Box of Set Screws High Tensile - UNF

Zinc plated steel. ANSI B18.2.1.1965 Grade 8.8 Equivalent.

Part No.	Box of
AB5N	150 Pieces
1 x 3/16" UNF: x 1", 1 x 1/4" UNF: x 1", 2 x 5/16" UNF: x 1", x 1 1/2". 2 x 3/8" UNF: x 1", 1 1/2".	



Spanner/Socket Size Guide

Use this guide to help choose the correct size spanner or socket required for standard Set Screw, Nut and Bolt thread sizes. Information for guidance only.

Thread Size	Spanner/Socket	Size	Pitch
M3	7 mm	7/16 UNF (Bolt)	5/8 AF
3/16 UNF	5/16 AF	M10	17 mm
M5	8 mm	7/16 UNF (Nut)	11/16 AF
M6	10 mm	M12	19 mm
M7	11 mm	1/2 UNF	3/4 AF
1/4 UNF	7/16 AF	M14	22 mm
5/16 UNF	1/2 AF	5/8 UNF	15/16 AF
M8	13 mm	M16	24 mm
3/8 UNF	9/16 AF		

Assorted Box of Set Screws High Tensile - UNC

Zinc plated steel. ANSI B18.2.1.1965 Grade 8.8 Equivalent.

Part No.	Box of
AB7N	150 Pieces
2 x 1/4" UNC: x 3/4", x 1". 2 x 5/16" UNC: x 1", x 1 1/2". 2 x 3/8" UNC: x 1", x 1 1/2".	





Bolts High Tensile - Metric

Zinc plated steel. DIN 931 Grade 8.8.

Part No.	Pack of	Size x Length
HBO36	100	M6 x 40
HBO70	50	M6 x 130
HBO37	100	M8 x 40
HBO71	50	M8 x 45
HBO72	50	M8 x 50
HBO73	50	M8 x 55
HBO74	50	M8 x 65
HBO75	25	M8 x 80
HBO76	25	M8 x 110
HBO77	25	M10 x 40
HBO26	100	M10 x 50
HBO78	25	M10 x 55
HBO79	25	M10 x 60
HBO80	25	M10 x 65
HBO81	25	M10 x 70
HBO82	25	M10 x 75
HBO83	25	M10 x 90
HBO21	100	M10 x 100
HBO84	25	M10 x 130
HBO85	25	M10 x 150
HBO22	100	M12 x 45
HBO27	100	M12 x 50
HBO23	100	M12 x 60
HBO28	50	M12 x 75
HBO86	25	M12 x 80
HBO87	25	M12 x 90
HBO33	25	M12 x 100
HBO88	25	M12 x 110
HBO89	25	M12 x 120
HBO90	25	M12 x 140
HBO91	25	M12 x 150
HBO29	50	M14 x 50
HBO30	50	M14 x 70
HBO92	25	M14 x 75
HBO93	25	M14 x 80
HBO34	25	M14 x 100
HBO94	25	M16 x 40
HBO24	50	M16 x 45
HBO31	50	M16 x 50
HBO25	50	M16 x 60
HBO32	25	M16 x 70
HBO95	10	M16 x 65
HBO96	10	M16 x 75
HBO97	10	M16 x 80
HBO98	10	M16 x 90
HBO35	25	M16 x 100
HBO99	10	M16 x 110
HBO100	10	M16 x 120
HBO101	10	M16 x 130

Part No.	Pack of	Size x Length
HBO102	10	M16 x 150
HBO103	10	M18 x 100
HBO104	10	M20 x 50
HBO105	10	M20 x 60
HBO106	10	M20 x 70
HBO107	10	M20 x 75
HBO108	10	M20 x 80
HBO109	10	M20 x 90
HBO110	10	M20 x 100
HBO111	10	M20 x 130
HBO112	5	M24 x 70
HBO113	5	M24 x 90
HBO114	5	M24 x 120



Bolts High Tensile - UNF

Zinc plated steel. ANSI B18.2.1.1965 Grade 5.

Part No.	Pack of	Size x Length
HBO2	100	5/16" x 2 1/4"
HBO3	100	5/16" x 2 3/4"
HBO4	100	3/8" x 1 1/4"
HBO13	100	3/8" x 1 1/2"
HBO61	100	3/8" x 2 1/2"
HBO62	50	3/8" x 3"
HBO63	25	3/8" x 4"
HBO5	100	7/16" x 1 1/2"
HBO6	100	7/16" x 2"
HBO7	50	7/16" x 3"
HBO8	50	1/2" x 1 1/2"
HBO9	50	1/2" x 2"
HBO14	50	1/2" x 2 1/2"
HBO10	50	1/2" x 3"
HBO15	25	1/2" x 4"
HBO64	10	1/2" x 5"
HBO11	50	5/8" x 2"
HBO16	25	5/8" x 2 1/2"
HBO12	25	5/8" x 3"
HBO17	25	5/8" x 4"
HBO65	10	5/8" x 5"
HBO66	25	3/4" x 3"
HBO67	25	3/4" x 4"
HBO68	10	3/4" x 5"





Coach Bolts with Steel Nuts, Cup Square Head - Metric, Fully Threaded

Zinc plated steel. DIN 603, Grade 4.8. Cup square head.

Part No.	Pack of	Size x Length
HCS7	100 Pairs	M6 x 20
HCS8	100 Pairs	M6 x 25
HCS9	100 Pairs	M6 x 30
HCS1	100 Pairs	M6 x 40
HCS10	50 Pairs	M6 x 50
HCS11	100 Pairs	M6 x 55
HCS2	100 Pairs	M6 x 75
HCS12	50 Pairs	M6 x 80
HCS13	50 Pairs	M6 x 90
HCS14	50 Pairs	M6 x 100
HCS15	25 Pairs	M6 x 110
HCS16	25 Pairs	M6 x 130
HCS17	50 Pairs	M8 x 25
HCS18	50 Pairs	M8 x 30
HCS19	50 Pairs	M8 x 35
HCS3	50 Pairs	M8 x 40
HCS20	50 Pairs	M8 x 50
HCS21	50 Pairs	M8 x 60
HCS4	50 Pairs	M8 x 75
HCS22	50 Pairs	M8 x 100
HCS23	25 Pairs	M8 x 120
HCS24	25 Pairs	M8 x 130
HCS25	25 Pairs	M8 x 150
HCS26	50 Pairs	M10 x 25
HCS27	50 Pairs	M10 x 30
HCS5	50 Pairs	M10 x 40
HCS28	50 Pairs	M10 x 50
HCS29	50 Pairs	M10 x 65
HCS6	50 Pairs	M10 x 75
HCS30	50 Pairs	M10 x 90
HCS31	50 Pairs	M10 x 100
HCS32	25 Pairs	M10 x 110
HCS33	25 Pairs	M10 x 120
HCS34	25 Pairs	M10 x 130
HCS35	25 Pairs	M10 x 150
HCS36	25 Pairs	M10 x 180
HCS37	25 Pairs	M10 x 220
HCS38	25 Pairs	M12 x 30
HCS39	25 Pairs	M12 x 50
HCS40	25 Pairs	M12 x 75
HCS41	25 Pairs	M12 x 100
HCS42	25 Pairs	M12 x 130
HCS43	25 Pairs	M12 x 150
HCS44	10 Pairs	M12 x 180
HCS45	10 Pairs	M12 x 200
HCS46	5 Pairs	M12 x 220



Coach Bolts with Steel Nuts, Cup Square Head - Metric

Zinc plated steel. BS 4933.

Part No.	Pack of	Size x Length
HCB1	100 Pairs	M6 x 40
HCB2	100 Pairs	M6 x 75
HCB3	50 Pairs	M8 x 40
HCB4	50 Pairs	M8 x 75
HCB5	50 Pairs	M10 x 40
HCB6	50 Pairs	M10 x 75



Roofing Bolts & Nuts - Metric

Zinc plated steel. DIN 603.

Part No.	Pack of	Size x Length
HRF520	100 Pairs	M5 x 20
HRF620	100 Pairs	M6 x 20
HRF625	100 Pairs	M6 x 25
HRF640	100 Pairs	M6 x 40
HRF650	100 Pairs	M6 x 50
HRF660	100 Pairs	M6 x 60
HRF680	50 Pairs	M6 x 80
HRF6100	50 Pairs	M6 x 100
HRF830	100 Pairs	M8 x 30
HRF835	100 Pairs	M8 x 35
HRF860	50 Pairs	M8 x 60
HRF880	50 Pairs	M8 x 80



Sleeve Anchors

Part No.	Pack of	Size
HCT10	50	M10 x 50
HCT12	50	M12 x 75

Metric Thread Pitch Sizes

Below is a listing of the popular standard pitch sizes for all metric (coarse) threaded products.

Size	Pitch	Size	Pitch
M3	0.50 mm	M12	1.75 mm
M4	0.70 mm	M14	2.00 mm
M5	0.80 mm	M16	2.00 mm
M6	1.00 mm	M18	2.50 mm
M7	1.00 mm	M20	2.50 mm
M8	1.25 mm	M22	2.50 mm
M10	1.50 mm	M24	3.00 mm

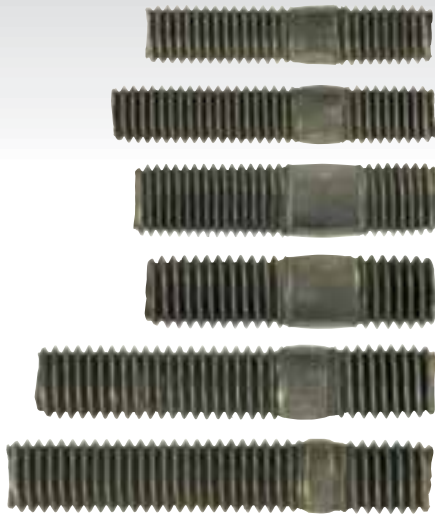

Exhaust Manifold Studs

Mild steel.

Part No.	Pack of	Size x Pitch	Length
HMS11	20	M8 x 1.25 mm	37 mm
HMS12	20	M8 x 1.25 mm	42 mm
HMS13	20	M10 x 1.25 mm	37 mm
HMS14	20	M10 x 1.50 mm	38 mm
HMS15	20	M10 x 1.50 mm	52 mm
HMS16	20	M10 x 1.50 mm	55 mm



Exhaust Manifold Nuts - Brass

Part No.	Pack of	Size x Pitch
HBN5	50	M8 x 1.25 mm
HBN6	50	M10 x 1.25 mm



Exhaust Manifold Nuts - Copper Flashed Steel

DIN 980.

Part No.	Pack of	Size x Pitch
HBN8	50	M8 x 1.25 mm
HBN7	50	M10 x 1.50 mm



Exhaust Manifold Nuts - Zinc Plated Steel

Non-serrated. Flanged tri-lock. 9/16" (14 mm) AF head. DIN 980. Grade 8.8.

Part No.	Pack of	Size
HBN10	50	M10 x 1.25 mm

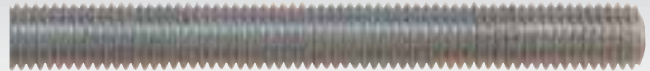

Studding - UNF, 36" (91 cm) Lengths

Zinc plated steel. DIN 975.

Part No.	Pack of	Size
HSR44	5	1/4"
HSR45	5	5/16"
HSR46	5	3/8"
HSR47	5	7/16"



Studding - Metric, 1 m (39") Lengths

Zinc plated mild steel. DIN 975. Grade 4.8.

Part No.	Pack of	Size
HSR26	5	M6
HSR28	5	M8
HSR30	5	M10
HSR32	5	M12
HSR34	4	M14
HSR36	4	M16
HSR38	2	M20
HSR40	2	M24

Assorted Pack of Studding - Metric, 1 m (39") Lengths

Zinc plated mild steel. DIN 975. Grade 4.8.

Part No.	Pack of
AP50	9 Pieces

3 x Sizes: M6, M8, M10



Assorted Pack of Studding - Metric, 30 cm (12") Lengths

Zinc plated mild steel. DIN 975. Grade 4.8.

Part No.	Pack of
AP8	30 Pieces

3 x Sizes: M6, M8, M10.



Looking for more Exhaust Products?

Exhaust clamps and fittings can be found on Page 266





Black Socket Screws, Cap Head - Metric

Black finish steel. DIN 912 Grade 12.9.

Part No.	Pack of	Size x Length	Thread Type	Hex/Socket Size
HCH38	200	M3 x 8	Full Thread	2.5 mm
HCH310	200	M3 x 10	Full Thread	2.5 mm
HCH312	200	M3 x 12	Full Thread	2.5 mm
HCH320	200	M3 x 20	Full Thread	2.5 mm
HCH330	200	M3 x 30	Part Thread	2.5 mm
HCH335	200	M3 x 35	Part Thread	2.5 mm
HCH410	200	M4 x 10	Full Thread	3 mm
HCH412	200	M4 x 12	Full Thread	3 mm
HCH416	200	M4 x 16	Full Thread	3 mm
HCH420	200	M4 x 20	Full Thread	3 mm
HCH425	200	M4 x 25	Full Thread	3 mm
HCH430	200	M4 x 30	Part Thread	3 mm
HCH440	200	M4 x 40	Part Thread	3 mm
HCH450	100	M4 x 50	Part Thread	3 mm
HCH56	200	M5 x 6	Full Thread	4 mm
HCH510	200	M5 x 10	Full Thread	4 mm
HCH512	200	M5 x 12	Full Thread	4 mm
HCH516	200	M5 x 16	Full Thread	4 mm
HCH520	200	M5 x 20	Full Thread	4 mm
HCH525	200	M5 x 25	Full Thread	4 mm
HCH530	200	M5 x 30	Part Thread	4 mm
HCH540	200	M5 x 40	Part Thread	4 mm
HCH550	100	M5 x 50	Part Thread	4 mm
HCH580	50	M5 x 80	Part Thread	4 mm
HCH610	200	M6 x 10	Full Thread	5 mm
HCH612	200	M6 x 12	Full Thread	5 mm
HCH615	200	M6 x 15	Full Thread	5 mm
HCH616	200	M6 x 16	Full Thread	5 mm
HCH620	200	M6 x 20	Full Thread	5 mm
HCH625	200	M6 x 25	Full Thread	5 mm
HCH630	200	M6 x 30	Full Thread	5 mm
HCH635	200	M6 x 35	Part Thread	5 mm
HCH640	200	M6 x 40	Part Thread	5 mm
HCH645	100	M6 x 45	Part Thread	5 mm
HCH650	100	M6 x 50	Part Thread	5 mm
HCH660	100	M6 x 60	Part Thread	5 mm
HCH665	100	M6 x 65	Part Thread	5 mm
HCH670	50	M6 x 70	Part Thread	5 mm
HCH810	200	M8 x 10	Full Thread	6 mm
HCH812	100	M8 x 12	Full Thread	6 mm
HCH816	200	M8 x 16	Full Thread	6 mm
HCH820	100	M8 x 20	Full Thread	6 mm
HCH825	100	M8 x 25	Full Thread	6 mm
HCH830	100	M8 x 30	Full Thread	6 mm
HCH835	100	M8 x 35	Full Thread	6 mm
HCH840	100	M8 x 40	Part Thread	6 mm
HCH845	50	M8 x 45	Part Thread	6 mm
HCH850	50	M8 x 50	Part Thread	6 mm
HCH860	50	M8 x 60	Part Thread	6 mm
HCH865	50	M8 x 65	Part Thread	6 mm
HCH870	50	M8 x 70	Part Thread	6 mm
HCH890	50	M8 x 90	Part Thread	6 mm
HCH1020	50	M10 x 20	Full Thread	8 mm
HCH1025	50	M10 x 25	Full Thread	8 mm
HCH1030	100	M10 x 30	Full Thread	8 mm
HCH1035	50	M10 x 35	Full Thread	8 mm
HCH1040	100	M10 x 40	Full Thread	8 mm
HCH1045	50	M10 x 45	Part Thread	8 mm
HCH1050	25	M10 x 50	Part Thread	8 mm

Part No.	Pack of	Size x Length	Thread Type	Hex/Socket Size
HCH1055	25	M10 x 55	Part Thread	8 mm
HCH1060	25	M10 x 60	Part Thread	8 mm
HCH1070	25	M10 x 70	Part Thread	8 mm
HCH1075	25	M10 x 75	Part Thread	8 mm
HCH1080	25	M10 x 80	Part Thread	8 mm
HCH1090	10	M10 x 90	Part Thread	8 mm
HCH10100	10	M10 x 100	Part Thread	8 mm
HCH1220	50	M12 x 20	Full Thread	10 mm
HCH1225	50	M12 x 25	Full Thread	10 mm
HCH1230	50	M12 x 30	Full Thread	10 mm
HCH1235	50	M12 x 35	Full Thread	10 mm
HCH1240	50	M12 x 40	Full Thread	10 mm
HCH1245	25	M12 x 45	Full Thread	10 mm
HCH1250	50	M12 x 50	Full Thread	10 mm
HCH1260	25	M12 x 60	Part Thread	10 mm
HCH1275	25	M12 x 75	Part Thread	10 mm
HCH1280	25	M12 x 80	Part Thread	10 mm
HCH1290	10	M12 x 90	Part Thread	10 mm
HCH12130	10	M12 x 130	Part Thread	10 mm
HCH1630	10	M16 x 30	Full Thread	14 mm
HCH1640	10	M16 x 40	Full Thread	14 mm
HCH1650	10	M16 x 50	Full Thread	14 mm
HCH1665	10	M16 x 65	Part Thread	14 mm
HCH1680	10	M16 x 80	Part Thread	14 mm
HCH1690	10	M16 x 90	Part Thread	14 mm
HCH16100	10	M16 x 100	Part Thread	14 mm
HCH16200	10	M16 x 200	Part Thread	14 mm
HCH2050	10	M20 x 50	Full Thread	17 mm
HCH2080	10	M20 x 80	Part Thread	17 mm
HCH2090	5	M20 x 90	Part Thread	17 mm
HCH20100	5	M20 x 100	Part Thread	17 mm
HCH20140	5	M20 x 140	Part Thread	17 mm
HCH20150	10	M20 x 150	Part Thread	17 mm
HCH2490	5	M24 x 90	Part Thread	19 mm
HCH24100	5	M24 x 100	Part Thread	19 mm

Assorted Box of Socket Screws Cap Head - Metric Black

Black. DIN 912 Grade 12.9.

Part No. Box of

AB92 100 Pieces

2 x M5: x 30, 40 mm. 2 x M6: x 30, 40 mm.
2 x M8: x 30, 40 mm. 2 x M10: x 30, 40 mm.



'Max Box' Assortment of Socket Screws Cap Head - Metric Black

Black. DIN 912 Grade 12.9.

Part No. Box of

AB562 270 Pieces

2 x M4: 12, 20 mm. 4 x M5: 16, 20, 30, 40 mm. 5 x M6: 12, 16, 20, 30, 40 mm.
4 x M8: 12, 20, 30, 40 mm. 2 x M10: 30, 40. 1 x M12: 50.



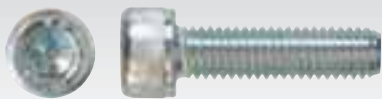

Socket Screws, Cap Head - Metric

Zinc plated steel. DIN 912 Grade 12.9.

Part No.	Pack of	Size x Length	Thread Type	Hex/Socket Size
HCZ308	200	M3 x 8	Full Thread	2.5 mm
HCZ316	100	M3 x 16	Full Thread	2.5 mm
HCZ420	100	M4 x 20	Full Thread	3 mm
HCZ430	100	M4 x 30	Part Thread	3 mm
HCZ510	100	M5 x 10	Full Thread	4 mm
HCZ516	100	M5 x 16	Full Thread	4 mm
HCZ525	100	M5 x 25	Full Thread	4 mm
HCZ530	50	M5 x 30	Part Thread	4 mm
HCZ535	50	M5 x 35	Part Thread	4 mm
HCZ540	50	M5 x 40	Part Thread	4 mm
HCZ620	100	M6 x 20	Full Thread	5 mm
HCZ625	100	M6 x 25	Full Thread	5 mm
HCZ630	100	M6 x 30	Full Thread	5 mm
HCZ635	50	M6 x 35	Part Thread	5 mm
HCZ816	50	M8 x 16	Full Thread	6 mm
HCZ820	50	M8 x 20	Full Thread	6 mm
HCZ830	50	M8 x 30	Full Thread	6 mm
HCZ845	25	M8 x 45	Part Thread	6 mm
HCZ865	50	M8 x 65	Part Thread	6 mm
HCZ1025	25	M10 x 25	Full Thread	8 mm
HCZ1030	25	M10 x 30	Full Thread	8 mm
HCZ1040	25	M10 x 40	Full Thread	8 mm
HCZ10130	25	M10 x 130	Part Thread	8 mm
HCZ1225	25	M12 x 25	Full Thread	10 mm
HCZ12100	10	M12 x 100	Part Thread	10 mm
HCZ12110	10	M12 x 110	Part Thread	10 mm
HCZ1660	10	M16 x 60	Full Thread	14 mm



'Max Box' Assortment of Socket Screws Cap Head - Metric

Zinc plated steel.
DIN 912 Grade 12.9.

Part No. Box of

AB563 300 Pieces

2 x M3: x 8, 16 mm. 2 x M4: x 20, 30 mm. 6 x M5: x 10, 16, 25, 30, 35, 40 mm. 4 x M6: x 20, 25, 30, 35 mm.
4 x M8: x 16, 20, 30, 45 mm. 3 x M10: x 25, 30, 40 mm. 1 x M12: x 25 mm.

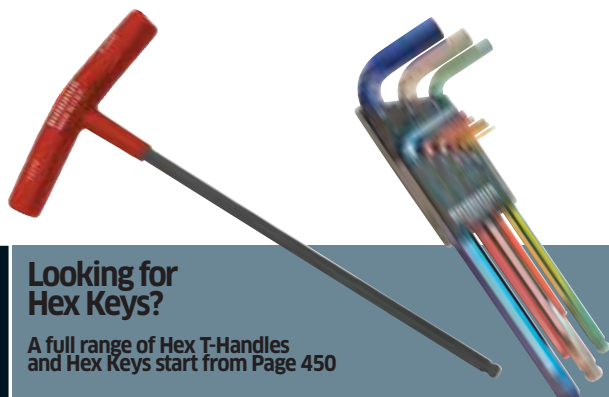

Looking for Hex Keys?

A full range of Hex T-Handles and Hex Keys start from Page 450

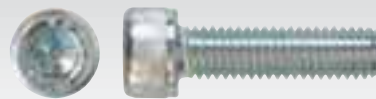

Socket Screws, Cap Head - UNC

Zinc plated steel. Grade 12.9.

Part No.	Pack of	Size x Length	Thread Type
HCZ1	100	1/4 UNC x 1/2"	Full Thread
HCZ2	100	1/4 UNC x 1 1/4"	Full Thread
HCZ3	100	1/4 UNC x 1 1/2"	Part Thread
HCZ4	100	1/4 UNC x 1 3/4"	Part Thread
HCZ5	50	1/4 UNC x 2"	Part Thread
HCZ6	50	5/16 UNC x 1"	Full Thread
HCZ7	50	5/16 UNC x 1 1/4"	Full Thread
HCZ8	50	3/8 UNC x 1"	Full Thread
HCZ9	25	3/8 UNC x 1 1/2"	Full Thread
HCZ10	25	3/8 UNC x 2"	Part Thread
HCZ11	10	1/2 UNC x 2"	Full Thread



Black Socket Screws, Button Head - Metric

Black finish steel. ISO 7380 Grade 10.9.

Part No.	Pack of	Size x Length	Thread Type	Hex/Socket Size
HBU410	200	M4 x 10	Full Thread	3 mm
HBU512	200	M5 x 12	Full Thread	4 mm
HBU516	200	M5 x 16	Full Thread	4 mm
HBU520	200	M5 x 20	Full Thread	4 mm
HBU525	200	M5 x 25	Full Thread	4 mm
HBU610	100	M6 x 10	Full Thread	5 mm
HBU612	100	M6 x 12	Full Thread	5 mm
HBU616	200	M6 x 16	Full Thread	5 mm
HBU625	100	M6 x 25	Full Thread	5 mm
HBU630	100	M6 x 30	Full Thread	5 mm
HBU810	100	M8 x 10	Full Thread	6 mm
HBU816	100	M8 x 16	Full Thread	6 mm
HBU820	100	M8 x 20	Full Thread	6 mm
HBU825	100	M8 x 25	Full Thread	6 mm
HBU830	100	M8 x 30	Full Thread	6 mm
HBU1040	50	M10 x 40	Full Thread	8 mm

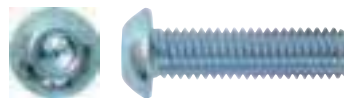

Socket Screws, Button Head - Metric

Zinc plated steel. ISO 7380 Grade 10.9.

Part No.	Pack of	Size x Length	Thread Type	Hex/Socket Size
HBZ620	100	M6 x 20	Full Thread	5 mm
HBZ820	100	M8 x 20	Full Thread	6 mm
HBZ830	100	M8 x 30	Full Thread	6 mm
HBZ840	100	M8 x 40	Part Thread	6 mm
HBZ1030	50	M10 x 30	Full Thread	8 mm
HBZ1035	50	M10 x 35	Full Thread	8 mm
HBZ1040	50	M10 x 40	Full Thread	8 mm





Black Socket Screws, Countersunk - Metric

Black finish steel. DIN 7991 Grade 10.9.

Part No.	Pack of	Size x Length	Thread Type	Hex/Socket Size
HKB36	200	M3 x 6	Full Thread	2.5 mm
HKB320	200	M3 x 20	Full Thread	2.5 mm
HKB412	200	M4 x 12	Full Thread	3 mm
HKB416	200	M4 x 16	Full Thread	3 mm
HKB420	200	M4 x 20	Full Thread	3 mm
HKB440	200	M4 x 40	Part Thread	3 mm
HKB510	200	M5 x 10	Full Thread	4 mm
HKB512	200	M5 x 12	Full Thread	4 mm
HKB516	200	M5 x 16	Full Thread	4 mm
HKB520	200	M5 x 20	Full Thread	4 mm
HKB525	200	M5 x 25	Full Thread	4 mm
HKB530	200	M5 x 30	Full Thread	4 mm
HKB612	200	M6 x 12	Full Thread	5 mm
HKB616	200	M6 x 16	Full Thread	5 mm
HKB620	200	M6 x 20	Full Thread	5 mm
HKB625	200	M6 x 25	Full Thread	5 mm
HKB630	100	M6 x 30	Full Thread	5 mm
HKB640	100	M6 x 40	Part Thread	5 mm
HKB820	100	M8 x 20	Full Thread	6 mm
HKB825	100	M8 x 25	Full Thread	6 mm
HKB830	100	M8 x 30	Full Thread	6 mm
HKB840	100	M8 x 40	Full Thread	6 mm
HKB850	100	M8 x 50	Part Thread	6 mm
HKB860	50	M8 x 60	Part Thread	6 mm
HKB1020	50	M10 x 20	Full Thread	8 mm
HKB1025	50	M10 x 25	Full Thread	8 mm
HKB1035	50	M10 x 35	Full Thread	8 mm
HKB1040	50	M10 x 40	Full Thread	8 mm
HKB1050	50	M10 x 50	Part Thread	8 mm
HKB1225	50	M12 x 25	Full Thread	10 mm
HKB1250	50	M12 x 50	Full Thread	10 mm
HKB1650	10	M16 x 50	Full Thread	14 mm
HKB1670	10	M16 x 70	Part Thread	14 mm
HKB1675	10	M16 x 75	Part Thread	14 mm
HKB20100	10	M20 x 100	Part Thread	17 mm

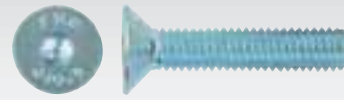

Socket Screws, Countersunk - Metric

Zinc plated steel. Grade 10.9.

Part No.	Pack of	Size x Length	Thread Type	Hex/Socket Size
HKZ460	100	M4 x 60	Part Thread	3 mm
HKZ620	100	M6 x 20	Full Thread	5 mm
HKZ640	100	M6 x 40	Part Thread	5 mm
HKZ825	100	M8 x 25	Full Thread	6 mm
HKZ830	100	M8 x 30	Full Thread	6 mm

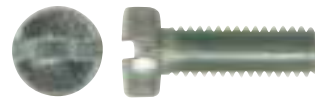

Machine Screws, Cheese Head, Slotted - Metric

Zinc plated steel. DIN 84 Grade 4.8.

Part No.	Pack of	Size x Length	Thread Type
HBH306	500	M3 x 6	Full Thread
HBH308	500	M3 x 8	Full Thread
HBH310	500	M3 x 10	Full Thread
HBH312	500	M3 x 12	Full Thread
HBH320	500	M3 x 20	Full Thread
HBH325	500	M3 x 25	Full Thread
HBH330	200	M3 x 30	Full Thread
HBH350	100	M3 x 50	Full Thread
HBH406	500	M4 x 6	Full Thread
HBH412	500	M4 x 12	Full Thread
HBH508	500	M5 x 8	Full Thread
HBH510	100	M5 x 10	Full Thread
HBH516	100	M5 x 16	Full Thread
HBH550	100	M5 x 50	Full Thread
HBH610	100	M6 x 10	Full Thread
HBH612	100	M6 x 12	Full Thread
HBH616	100	M6 x 16	Full Thread
HBH620	100	M6 x 20	Full Thread
HBH625	100	M6 x 25	Full Thread

Assorted Box of Machine Screws Cheese Head, Slotted - Metric

Zinc plated steel. DIN 84 Grade 4.8.

Part No.	Box of
AB209N	435 Pieces
8 x M3: x 6, 8, 10, 12, 20, 25, 30, 50 mm.	
2 x M4: x 6, 12 mm. 1 x M5: x 8. 2 x M6: 10, 20 mm.	



Hex Key/Socket Size Guide

Use this guide to help choose the correct size hex key or hex bit socket required for standard Socket Cap Screw thread sizes. Information for guidance only.

Thread Size	Hex Size	Thread Size	Hex Size
M3	2.5 mm	M10	8 mm
M4	3 mm	M12	10 mm
M5	4 mm	M16	14 mm
M6	5 mm	M20	17 mm
M8	6 mm	M24	19 mm



Machine Screws with Nuts, Pan Head, Slotted - Metric

Zinc plated steel. DIN 85 & 934.

Part No.	Pack of	Size x Length	Thread Type
HBA10	100 Pairs	M3 x 8	Full Thread
HBA11	100 Pairs	M3 x 20	Full Thread
HBA12	100 Pairs	M4 x 20	Full Thread
HBA16	100 Pairs	M4 x 25	Full Thread
HBA13	100 Pairs	M4 x 40	Full Thread
HBA14	100 Pairs	M5 x 25	Full Thread
HBA17	100 Pairs	M5 x 40	Full Thread
HBA15	100 Pairs	M5 x 50	Full Thread

Assorted Box of Machine Screws with Nuts & Washers, Pan Head, Slotted - Metric

Zinc plated steel. DIN 85 & DIN 934.

Part No. Box of

AB68N 840 Pieces

6 x Machine Screws: M3 x 8 mm, M3 x 20 mm, M4 x 20 mm, M4 x 40 mm, M5 x 25 mm, M5 x 50 mm.
3 x Nuts: M3, M4, M5. 3 x Washers: M3, M4, M5.



Assorted Box of Machine Screws with Nuts, Round Head, Slotted - BA

Brass. BS 57.

Part No. Box of

AB4N 410 Pieces

10 x Machine Screws: 6BA x 1/2", 6BA x 3/4", 6BA x 1", 4BA x 1/2", 4BA x 3/4", 4BA x 1", 2BA x 1/2", 2BA x 3/4", 2BA x 1", 2BA x 1 1/2". 3 x Nuts: 6BA, 4BA, 2BA.

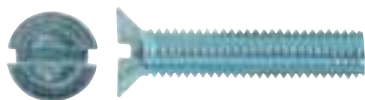

Machine Screws, Slotted Countersunk - Metric

Zinc plated steel. BS 57.

Part No.	Pack of	Size x Length	Thread Type
HBT510	100	M5 x 10	Full Thread
HBT516	100	M5 x 16	Full Thread
HBT525	100	M5 x 25	Full Thread
HBT550	100	M5 x 50	Full Thread
HBT625	100	M6 x 25	Full Thread
HBT650	100	M6 x 50	Full Thread

Metric Thread Pitch Sizes

Below is a listing of the popular standard pitch sizes for all metric (coarse) threaded products.

Size	Pitch	Size	Pitch
M3	0.50 mm	M12	1.75 mm
M4	0.70 mm	M14	2.00 mm
M5	0.80 mm	M16	2.00 mm
M6	1.00 mm	M18	2.50 mm
M7	1.00 mm	M20	2.50 mm
M8	1.25 mm	M22	2.50 mm
M10	1.50 mm	M24	3.00 mm

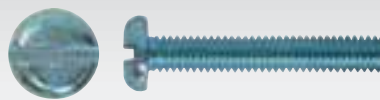

Machine Screws, Pan Head Slotted - Metric

Zinc plated steel.

Part No.	Pack of	Size x Length	Thread Type
HBS36	100	M3 x 6	Full Thread
HBS320	100	M3 x 20	Full Thread
HBS325	100	M3 x 25	Full Thread
HBS340	100	M3 x 40	Full Thread
HBS48	100	M4 x 8	Full Thread
HBS416	100	M4 x 16	Full Thread
HBS425	100	M4 x 25	Full Thread
HBS440	100	M4 x 40	Full Thread
HBS512	100	M5 x 12	Full Thread
HBS516	100	M5 x 16	Full Thread
HBS525	100	M5 x 25	Full Thread
HBS540	100	M5 x 40	Full Thread
HBS550	100	M5 x 50	Full Thread
HBS625	100	M6 x 25	Full Thread
HBS640	50	M6 x 40	Full Thread
HBS650	50	M6 x 50	Full Thread

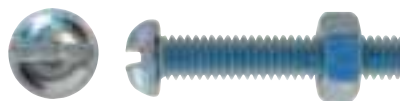

Machine Screws with Nuts, Round Head, Slotted - BA

Zinc plated steel. BS 57.

Part No.	Pack of	Size x Length	Thread Type
HBA8	100 Pairs	6BA x 3/4"	Full Thread
HBA1	100 Pairs	6BA x 1"	Full Thread
HBA9	100 Pairs	4BA x 3/4"	Full Thread
HBA3	100 Pairs	4BA x 1"	Full Thread
HBA4	100 Pairs	4BA x 2"	Full Thread
HBA5	100 Pairs	2BA x 1"	Full Thread
HBA7	100 Pairs	2BA x 1 1/2"	Full Thread
HBA6	100 Pairs	2BA x 2"	Full Thread

Assorted Box of Machine Screws with Nuts, Round Head, Slotted - BA

Zinc plated steel. BS 57.

Part No. Box of

AB3 1,025 Pieces

8 x Machine Screws: 6BA x 3/4", 6BA x 1", 4BA x 3/4", 4BA x 1", 4BA x 2", 2BA x 1, 2BA x 1 1/2", 2BA x 2".
3 x Nuts: 6BA, 4BA, 2BA.



Looking for Body Screws?

The Machine Screws range continues overleaf

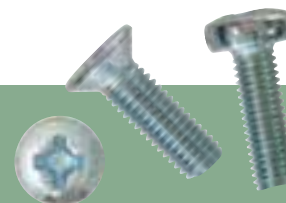

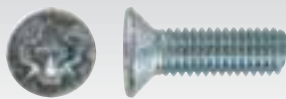

Machine Screws (Body Screws), Countersunk, Pozi - Metric

Zinc plated steel. DIN 965.

Part No.	Pack of	Size x Length	Thread Type
HBC520	200	M5 x 20	Full Thread
HBC525	200	M5 x 25	Full Thread
HBC550	200	M5 x 50	Full Thread
HBC610	200	M6 x 10	Full Thread
HBC612	200	M6 x 12	Full Thread
HBC620	200	M6 x 20	Full Thread
HBC625	200	M6 x 25	Full Thread
HBC650	200	M6 x 50	Full Thread
HBC820	200	M8 x 20	Full Thread
HBC825	200	M8 x 25	Full Thread



Assorted Box of Machine Screws (Body Screws) Countersunk, Pozi - Metric

Zinc plated steel. DIN 965.

Part No.	Box of
AB135N	250 Pieces

2 x M5: x 20, 25 mm. 3 x M6: x 20, 25, 50 mm.
1 x M8: x 20 mm.

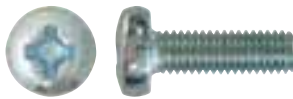

Machine Screws (Body Screws), Pan Head, Pozi - Metric

Zinc plated steel. DIN 7985.

Part No.	Pack of	Size x Length	Thread Type
HBP312	200	M3 x 12	Full Thread
HBP330	200	M3 x 30	Full Thread
HBP412	200	M4 x 12	Full Thread
HBP435	200	M4 x 35	Full Thread
HBP450	200	M4 x 50	Full Thread
HBP516	200	M5 x 16	Full Thread
HBP520	200	M5 x 20	Full Thread
HBP525	200	M5 x 25	Full Thread
HBP540	100	M5 x 40	Full Thread
HBP550	100	M5 x 50	Full Thread
HBP68	200	M6 x 8	Full Thread
HBP610	200	M6 x 10	Full Thread
HBP616	200	M6 x 16	Full Thread
HBP620	200	M6 x 20	Full Thread
HBP625	200	M6 x 25	Full Thread
HBP820	200	M8 x 20	Full Thread
HBP825	200	M8 x 25	Full Thread



Assorted Box of Machine Screws (Body Screws) Pan Head, Pozi - Metric

Zinc plated steel. DIN 7985.

Part No.	Box of
AB134N	290 Pieces

3 x M4: x 12, 35, 50 mm. 4 x M5: x 20, 25, 40, 50 mm.
2 x M6: x 20, 25 mm.



Thread Insert System Kits

Supplied in a robust plastic storage case.

Part No.	Qty	Size	Pitch
HRK105	1 Kit	M5	0.80 mm
HRK106	1 Kit	M6	1.00 mm
HRK108	1 Kit	M8	1.25 mm
HRK110	1 Kit	M10	1.50 mm
HRK112	1 Kit	M12	1.75 mm

Kit contains:
1 x Pre-wind Installation Tool. 1 x HSS-G Tap. 1 x HSS Drill: 5.2 mm
1 x Tang Break-off Tool. No. 8. 20 x Inserts.



Insert Replacement Packs - Metric

Part No.	Pack of	Size	Pitch
HRP105	10	M5	0.80 mm
HRP106	10	M6	1.00 mm
HRP108	10	M8	1.25 mm
HRP110	10	M10	1.50 mm
HRP112	10	M12	1.75 mm



Thread Repair Kit - Spark Plug Inserts

Supplied in a robust plastic storage case.

Part No.	Qty	Size	Pitch
HRK214	1 Kit	M14	1.25 mm

Kit contains:
1 x Pre-wind Installation Tool. 1 x HSS-G Tap: 5 x Inserts M14 x 1.25 mm:
8.4 mm, 12.4 mm, 16.4 mm Reach.



Insert Replacement Packs - Spark Plug M14 x 1.25 mm

Part No.	Pack of	Size x Pitch	Reach
HRP208	10	M14 x 1.25 mm	1/2"
HRP212	10	M14 x 1.25 mm	3/4"



Metric Thread Pitch Sizes

Below is a listing of the popular standard pitch sizes for all metric (coarse) threaded products.

Size	Pitch	Size	Pitch
M3	0.50 mm	M12	1.75 mm
M4	0.70 mm	M14	2.00 mm
M5	0.80 mm	M16	2.00 mm
M6	1.00 mm	M18	2.50 mm
M7	1.00 mm	M20	2.50 mm
M8	1.25 mm	M22	2.50 mm
M10	1.50 mm	M24	3.00 mm



ECLIPSE-SPIRALUX Threaded Insert Tool Kit

Complete with nose bush and mandrel conversions and inserts. For quick, manual insertion of permanent load bearing threads in materials from 0.20" to 0.128". Supplied in a plastic storage box.

Part No.	Qty	Description
TL831	1 Kit	Threaded Insert Tool Kit

1 x Insert Tool. 4 x Nose Bush/Mandrels: 4, 5, 6, 8 mm. 10 x Threaded Inserts: 4, 5, 6, 8 mm.

ECLIPSE-SPIRALUX Nose Bush & Mandrel Kits

Suits Part No. TL831.

Part No.	Qty	Size
TL832	1 Kit	4 mm
TL834	1 Kit	6 mm
TL833	1 Kit	5 mm
TL835	1 Kit	8 mm



**BEST
SELLER**

Threaded Inserts - Regular

Zinc plated steel.

Part No.	Pack of	Size
NST4	50	M4
NST5	50	M5
NST6	50	M6
NST8	50	M8



Assorted Box of Threaded Inserts - Regular

Zinc plated steel.

Part No.	Box of
AB78N	250 Pieces

5 x Sizes: M4, M5, M6, M8, M10.



Threaded Inserts - Half Hex

Zinc plated steel.

Part No.	Pack of	Size
NST14	50	M4
NST15	50	M5
NST16	50	M6
NST18	50	M8



Assorted Box of Threaded Inserts - Half Hex

Zinc plated steel.

Part No.	Box of
AB182	225 Pieces

4 x Sizes: M4, M5, M6, M8.



**BEST
SELLER**

Threaded Inserts - Splined

Zinc plated steel.

Part No.	Pack of	Size
NST24	50	M4
NST25	50	M5
NST26	50	M6
NST28	50	M8
NST10	50	M10



Assorted Box of Threaded Inserts - Splined

Zinc plated steel.

Part No.	Box of
AB183	225 Pieces

4 x Sizes: M4, M5, M6, M8.



Threaded Inserts - Cylindrical Head Full Hex

Zinc plated steel. Large flange.

Part No.	Pack of	Size
NST34	50	M4
NST35	50	M5
NST36	50	M6
NST38	50	M8
NST40	50	M10



Assorted Box of Threaded Inserts - Cylindrical Head Full Hex

Zinc plated steel. Large flange.

Part No.	Box of
AB181	250 Pieces

5 x Sizes: M4, M5, M6, M8, M10





Steel Nuts - Metric

Zinc plated steel. DIN 934.

Part No.	Pack of	Size
HSN19	200	M3
HSN20	200	M4
HSN21	200	M5
HSN22	200	M6
HSN23	200	M7
HSN24	200	M8
HSN25	200	M10
HSN26	100	M12
HSN28	100	M14
HSN27	100	M16
HSN29	25	M20
HSN30	25	M24

Assorted Box of Steel Nuts - Metric

Zinc plated steel. DIN 934.

Part No.	Box of
AB202N	275 Pieces

8 x Sizes: M4, M5, M6, M8, M10, M12, M14, M16.



Assorted Box of Steel Nuts - Metric (Popular Sizes)

Zinc plated steel. DIN 934.

Part No.	Box of
AB10N	370 Pieces

5 x Sizes: M5, M6, M8, M10, M12.

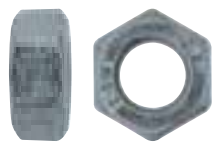

Steel Nuts - Metric Fine

Zinc plated steel. DIN 934.

Part No.	Pack of	Size x Pitch
HSN31	200	M5 x 0.50 mm
HSN32	200	M6 x 0.75 mm
HSN33	200	M8 x 1.00 mm
HSN35	100	M10 x 1.00 mm
HSN34	200	M10 x 1.25 mm
HSN37	100	M12 x 1.50 mm*
HSN36	100	M12 x 1.25 mm*
HSN38	50	M16 x 1.50 mm*

Assorted Box of Steel Nuts - Metric Fine

Zinc plated steel. DIN 934.

Part No.	Box of
AB12N	350 Pieces

7 x Sizes: M5 x 0.50 mm, M6 x 0.75 mm, M8 x 1.00 mm, M10 x 1.00 mm, M10 x 1.25 mm, M12 x 1.25 mm, M12 x 1.50 mm.



Stainless Steel Nuts - Metric

Stainless Steel. DIN 934 Grade A2.

Part No.	Pack of	Size
HIN105	200	M5
HIN106	200	M6
HIN108	100	M8
HIN110	100	M10

Assorted Box of Stainless Steel Nuts - Metric

Stainless Steel. DIN 934 Grade A2.

Part No.	Box of
AB155	250 Pieces

4 x Sizes: M5, M6, M8, M10.

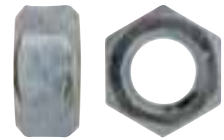

Steel Nuts - UNF

Zinc plated steel. ANSI B18.2.2.

Part No.	Pack of	Size
HSN1	200	3/16" UNF
HSN2	200	1/4" UNF
HSN3	200	5/16" UNF
HSN4	200	3/8" UNF
HSN5	100	7/16" UNF
HSN6	100	1/2" UNF
HSN7	100	5/8" UNF
HSN8	50	3/4" UNF

Assorted Box of Steel Nuts - UNF

Zinc plated steel. ANSI B18.2.2.

Part No.	Box of
AB6N	325 Pieces

4 x UNF: 3/16", 1/4", 5/16", 3/8".



Assorted Box of Steel Nuts - UNC

Zinc plated steel. ANSI B18.2.2.

Part No.	Box of
AB8N	350 Pieces

3 x UNC: 1/4", 5/16", 3/8".

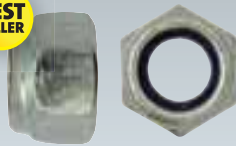

**BEST
SELLER**

Nylon Lock Nuts - Metric

Zinc plated steel.
P-Type. DIN 982.

Part No.	Pack of	Size
HNN19	200	M4
HNN20	100	M5
HNN21	100	M6
HNN22	100	M8
HNN23	100	M10
HNN24	100	M12
HNN26	50	M14
HNN25	25	M16
HNN27	25	M20

Assorted Box of Nylon Lock Nuts - Metric

Zinc plated steel.
P-Type. DIN 982.

Part No.	Box of
AB201N	275 Pieces

8 x Sizes: M4, M5, M6, M8, M10, M12, M14, M16.



Assorted Box of Nylon Lock Nuts - Metric (Popular Sizes)

Zinc plated steel. P-Type. DIN 982.

Part No.	Box of
AB15N	300 Pieces

4 x Sizes: M6, M8, M10, M12.



'Max Box' Assortment of Steel Nuts & Nylon Lock Nuts

Zinc plated steel.
DIN 934 (Steel Nuts)/DIN 982 (Nylon Lock Nuts, P-Type).

Part No.	Box of
AB510	400 Pieces

5 x Sizes, Steel Nuts: M5, M6, M8, M10, M12. 7 x Sizes, Nylon Lock Nuts: M5, M6, M7, M8, M10, M12, M14.

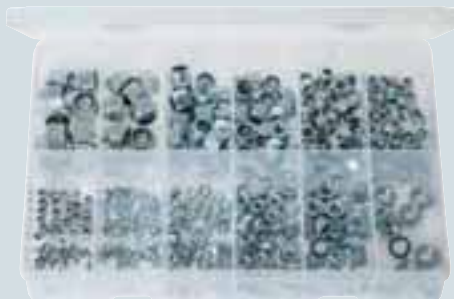

Nylon Lock Nuts - Metric Fine

Zinc plated steel.
T-Type. DIN 985.

Part No.	Pack of	Size	Pitch
HNN32	50	M8	1.00 mm
HNN33	50	M10	1.00 mm
HNN34	50	M10	1.25 mm
HNN35	50	M12	1.25 mm
HNN36	50	M12	1.50 mm

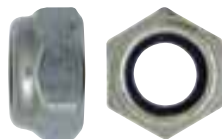

Stainless Steel Nylon Lock Nuts - Metric

Stainless Steel.
T-Type. DIN 985 Grade A2.

Part No.	Pack of	Size
HIL105	100	M5
HIL106	100	M6
HIL108	50	M8
HIL110	50	M10

Assorted Box of Stainless Steel Nylon Lock Nuts - Metric

Stainless Steel. T-Type. DIN 985 Grade A2.

Part No.	Box of
AB156N	225 Pieces

4 x Sizes: M5, M6, M8, M10.



Nylon Lock Nuts - UNF

Zinc plated steel.
BS 4929 Equivalent.

Part No.	Pack of	Size
HNN1	100	1/4"
HNN2	100	5/16"
HNN3	100	3/8"
HNN4	100	7/16"
HNN5	50	1/2"
HNN6	25	5/8"



Assorted Box of Nylon Lock Nuts - UNF

Zinc plated steel.
BS 4929 Equivalent.

Part No.	Box of
AB13N	290 Pieces

5 x UNF: 1/4", 5/16", 3/8", 7/16", 1/2".



Assorted Box of Nylon Lock Nuts - UNC

Zinc plated steel.
BS 4929 Equivalent.

Part No.	Box of
AB14N	275 Pieces

4 x UNC: 1/4", 5/16", 3/8", 1/2".



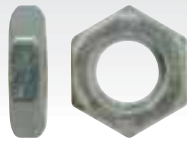

Thin (Half) Nuts - Metric

Zinc plated steel. DIN 439 Part 2.

Part No.	Pack of	Size
HNU108	200	M8
HNU110	100	M10
HNU112	50	M12
HNU114	50	M14
HNU116	50	M16



Wing Nuts - Metric

Zinc plated steel.

Part No.	Pack of	Size
HWN1	50	M5
HWN2	50	M6
HWN3	25	M8
HWN4	25	M10



Brass Nuts - BA

BS 57.

Part No.	Pack of	Size
HBN40	100	6BA
HBN41	100	4BA
HBN42	100	2BA

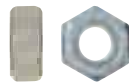

Steel Nuts - BA

Zinc plated steel. BS 57.

Part No.	Pack of	Size
HSN40	200	6BA
HSN41	200	4BA
HSN42	200	2BA



Serrated Flange Nuts - Metric

Zinc plated steel. DIN 6923.

Part No.	Pack of	Size
HSN55	200	M5
HSN56	200	M6
HSN58	200	M8
HSN60	100	M10
HSN62	100	M12
HSN64	50	M14
HSN66	50	M16



Assorted Box of Serrated Flange Nuts - Metric

Zinc plated steel. DIN 6923.

Part No.	Box of
AB104N	330 Pieces

5 x Sizes: M5, M6, M8, M10, M12.



Combi Nuts with Captive Washers

Zinc plated steel.

Part No.	Pack of	Size
HSN76	50	M6
HSN78	50	M8



Locknuts For Thermocouples

Brass

Part No.	Pack of	Description
GAS63	20	Thermocouple Locknuts

Metric Thread Pitch Sizes

Below is a listing of the popular standard pitch sizes for all metric (coarse) threaded products.

Size	Pitch	Size	Pitch
M3	0.50 mm	M12	1.75 mm
M4	0.70 mm	M14	2.00 mm
M5	0.80 mm	M16	2.00 mm
M6	1.00 mm	M18	2.50 mm
M7	1.00 mm	M20	2.50 mm
M8	1.25 mm	M22	2.50 mm
M10	1.50 mm	M24	3.00 mm



Exhaust Manifold Nuts - Brass

Part No.	Pack of	Size x Pitch
HBN5	50	M8 x 1.25 mm
HBN6	50	M10 x 1.25 mm

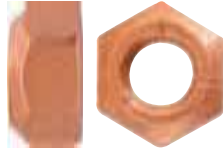

Exhaust Manifold Nuts - Copper Flashed Steel

DIN 980.

Part No.	Pack of	Size x Pitch
HBN8	50	M8 x 1.25 mm
HBN7	50	M10 x 1.50 mm



Exhaust Manifold Nuts - Zinc Plated Steel

Non-serrated. Flanged tri-lock. 9/16" (14 mm) AF head. DIN 980. Grade 8.8.

Part No.	Pack of	Size
HBN10	50	M10 x 1.25 mm

**BEST
SELLER**



Repair Washers - Imperial

Zinc plated steel. 1.37/1.69 mm thickness.

Part No.	Pack of	I.D. x O.D.
HRW13	200	3/16" x 3/4"
HRW1	200	3/16" x 1"
HRW14	200	1/4" x 3/4"
HRW2	200	1/4" x 1"
HRW6	200	1/4" x 1 1/2"
HRW3	200	5/16" x 1"
HRW4	200	5/16" x 1 1/2"
HRW8	100	5/16" x 2"
HRW15	100	3/8" x 1 1/4"
HRW5	200	3/8" x 1 1/2"
HRW7	100	3/8" x 2"

Assorted Box of Repair Washers - Imperial

Zinc plated steel. 1.37/1.69 mm thickness.

Part No.	Box of
AB22N	220 Pieces

6 x Sizes (I.D. x O.D.): 3/16" x 1", 1/4" x 1", 1/4" x 1 1/2", 5/16" x 1", 5/16" x 1 1/2", 3/8" x 1 1/2".



Repair Washers - Metric

Zinc plated steel.

Part No.	Pack of	I.D. x O.D.
HRW520	200	M5 x 20
HRW620	100	M6 x 20
HRW830	200	M8 x 30
HRW1025	100	M10 x 25
HRW1040	100	M10 x 40



Looking for Exhaust Manifold Studs?

Manifold Studs can be found back on Page 119





BEST SELLER

Flat Washers 'Form C' - Metric

Zinc plated steel.
BS 4320 Form C.

Part No.	Pack of	I.D. x O.D.
HFW59	1,000	M5 x 12.5
HFW60	500	M6 x 14
HFW61	500	M8 x 21
HFW62	250	M10 x 24
HFW63	250	M12 x 28
HFW64	100	M14 x 30
HFW65	100	M16 x 34
HFW66	100	M20 x 39
HFW67	50	M24 x 50



BEST SELLER

Flat Washers 'Form A' - Metric

Zinc plated steel.
DIN 125 Type A. Heavy Gauge.

Part No.	Pack of	I.D. x O.D.
HFW10	1,000	M3 x 7
HFW11	1,000	M4 x 9
HFW12	1,000	M5 x 10
HFW13	500	M6 x 12
HFW14	500	M8 x 17
HFW15	250	M10 x 21
HFW16	250	M12 x 24
HFW19	100	M14 x 28
HFW17	100	M16 x 30
HFW18	100	M20 x 37
HFW20	50	M24 x 44

Assorted Box of Flat Washers 'Form C' - Metric

Zinc plated steel. BS 4320 Form C.

Part No.	Box of
AB119N	620 Pieces

6 x Sizes: M6, M8, M10, M12, M14, M16.



Assorted Box of Flat Washers 'Form A' - Metric

Zinc plated steel. DIN 125 Type A. Heavy Gauge.

Part No.	Box of
AB76N	800 Pieces

9 x Sizes: M3, M4, M5, M6, M8, M10, M12, M16, M20.



Flat Washers 'Table 4' - Imperial

Zinc plated steel.
BS 3410 Table 4 (Heavy Gauge).

Part No.	Pack of	I.D. x O.D.
HFW40	1,000	3/16" x 1/2"
HFW41	500	1/4" x 5/8"
HFW42	500	5/16" x 3/4"
HFW43	500	3/8" x 7/8"
HFW44	200	7/16" x 1"
HFW45	200	1/2" x 1 1/8"
HFW46	100	9/16" x 1 1/4"
HFW47	100	5/8" x 1 3/8"
HFW48	100	3/4" x 1 5/8"
HFW49	50	7/8" x 1 7/8"
HFW50	50	1" x 2 1/8"
HFW51	25	1 1/8" x 2 3/8"
HFW52	25	1 1/4" x 2 5/8"
HFW53	25	1 3/8" x 2 7/8"
HFW54	25	1 1/2" x 3 1/8"

Flat Washers 'Table 3' - Imperial

Zinc plated steel.
BS 3410 Table 3 (Heavy Gauge).

Part No.	Pack of	I.D. x O.D.
HFW1	1,000	3/16" x 7/16"
HFW2	500	1/4" x 9/16"
HFW3	500	5/16" x 5/8"
HFW4	500	3/8" x 3/4"
HFW5	250	7/16" x 7/8"
HFW6	250	1/2" x 1"
HFW7	100	5/8" x 1 1/4"
HFW8	100	3/4" x 1 1/2"



Assorted Box of Flat Washers 'Table 4' - Imperial

Zinc plated steel. BS 3410 Table 4 (Heavy Gauge).

Part No.	Box of
AB109N	920 Pieces

6 x Sizes: 3/16" x 1/2", 1/4" x 5/8", 5/16" x 3/4", 3/8" x 7/8", 1/2" x 1 1/8", 5/8" x 1 3/8".



Assorted Box of Flat Washers 'Table 3' - Imperial

Zinc plated steel. BS 3410 Table 3 (Heavy Gauge).

Part No.	Box of
AB20N	800 Pieces

6 x Sizes: 3/16", 1/4", 5/16", 3/8", 7/16", 1/2".





Stainless Steel Flat Washers 'Form B' - Metric

Stainless Steel. BS 4320 [Table 1] Form B Grade A2.
*DIN 125A (BS 4320 [Table 1] Form A) Grade A2.

Part No.	Pack of	I.D. x O.D.
HIW105	1,000	M5 x 10*
HIW106	500	M6 x 12
HIW108	500	M8 x 17
HIW110	250	M10 x 21

Assorted Box of Stainless Steel Flat Washers - Metric

Stainless Steel. BS 4320 [Table 1] Form B Grade A2. *DIN 125A (BS 4320 [Table 1] Form A) Grade A2.

Part No.	Box of
AB157	650 Pieces

4 x Sizes: M5*, M6, M8, M10.



Stainless Steel Spring Washers - Metric

Stainless Steel. Square Section.
DIN 7980 Grade A2.

Part No.	Pack of	I.D.
HIP105	500	M5
HIP106	250	M6
HIP108	250	M8
HIP110	100	M10

Assorted Box of Stainless Steel Spring Washers - Metric

Stainless Steel. Square Section.
DIN 7980 Grade A2.

Part No.	Box of
AB158	650 Pieces

4 x Sizes: M5, M6, M8, M10.



**BEST
SELLER**



Spring Washers - Metric

Zinc plated steel. Rectangular Section.
DIN 127B.

Part No.	Pack of	Size
HSW9	1,000	M4
HSW10	500	M5
HSW11	300	M6
HSW12	300	M8
HSW13	300	M10
HSW14	150	M12
HSW17	100	M14
HSW15	50	M16
HSW18	50	M18
HSW16	50	M20
HSW19	25	M24

Assorted Box of Spring Washers - Metric

Zinc plated steel. Rectangular Section.
DIN 127B.

Part No.	Box of
AB77N	1,015 Pieces

8 x Sizes: M4, M5, M6, M8, M10, M12, M16, M20.



Spring Washers - Imperial

Zinc plated steel. Rectangular Section.
ANSI B18.21.1 Table 2.

Part No.	Pack of	I.D.
HSW1	1,000	3/16"
HSW2	500	1/4"
HSW3	500	5/16"
HSW4	500	3/8"
HSW5	250	7/16"
HSW6	250	1/2"
HSW8	100	3/4"
HSW20	25	7/8"
HSW21	25	1"



Assorted Box of Spring Washers - Imperial

Zinc plated steel. Rectangular Section
ANSI B18.21.1 Table 2.

Part No.	Box of
AB21N	800 Pieces

6 x Sizes: 3/16", 1/4", 5/16", 3/8", 7/16", 1/2".





Copper Washers

WS 086.

Part No.	Pack of	I.D. x O.D.	Thickness	Equiv.
HCW5	100	3/16" x 7/16"	0.8 mm	(M5 x 11)
HCW6	100	1/4" x 9/16"	0.8 mm	(M6 x 14)
HCW8	100	5/16" x 5/8"	0.8 mm	(M8 x 16)
HCW10	100	3/8" x 3/4"	0.8 mm	(M10 x 19)
HCW11	100	7/16" x 7/8"	1.3 mm	
HCW12	100	1/2" x 1"	1.3 mm	(M12 x 25)

Assorted Box of Copper Washers - Imperial

WS 086.

Part No. Box of

AB24N 400 Pieces

6 x Sizes: 3/16" x 7/16", 1/4" x 9/16", 5/16" x 5/8", 3/8" x 3/4", 7/16" x 7/8", 1/2" x 1" (M5, M6, M8, M10, M12).



Lock Washers, Serrated Internal - Metric

Zinc plated steel. DIN 6798.

Part No.	Pack of	I.D.
HLW1	1,000	M5
HLW2	500	M6
HLW3	500	M8
HLW4	500	M10
HLW5	250	M11
HLW6	250	M13

Assorted Box of Lock Washers Serrated - Internal

Zinc plated steel. DIN 6798.

Part No. Box of

AB27N 800 Pieces

6 x Sizes: M5, M6, M8, M10, M11, M13.



Rivet Washers

Zinc plated steel.

Part No.	Pack of	Size
PRW1	1,000	M3 x 13 (1/8" x 1/2")

Lock Washers, Serrated External - Metric

Zinc plated steel.

Part No.	Pack of	I.D.
HLW20	1,000	M4
HLW21	500	M5
HLW22	500	M6
HLW23	250	M8
HLW24	100	M10
HLW29	50	M12
HLW27	50	M14
HLW28	50	M16

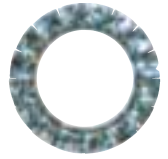

Assorted Box of Shim Washers

Zinc plated steel.

Part No. Box of

AB28N 315 Pieces

8 x 0.010 Thick: 3/16" x 7/16", 1/4" x 9/16", 5/16" x 5/8", 3/8" x 3/4", 7/16" x 7/8", 1/2" x 1", 5/8" x 1 1/4", 3/4" x 1 1/2".
7 x 0.015 Thick: 1/4" x 9/16", 5/16" x 5/8", 3/8" x 3/4", 7/16" x 7/8", 1/2" x 1", 5/8" x 1 1/4", 3/4" x 1 1/2".



Assorted Box of Lock Washers Serrated - External

Zinc plated steel.

Part No. Box of

AB208N 440 Pieces

8 x Sizes: M4, M5, M6, M8, M10, M12, M14, M16.





Fibre Washers - Metric

DIN 7603A.

Part No.	Pack of	I.D. x O.D. x Thickness
HFB5	100	M5 x 9 x 1.0
HFB6	100	M6 x 10 x 1.0
HFB8	100	M8 x 12 x 1.0
HFB10	100	M10 x 14 x 1.0
HFB12	100	M12 x 18 x 1.5
HFB14	100	M14 x 20 x 1.5
HFB16	100	M16 x 22 x 1.5
HFB18	100	M18 x 24 x 1.5

Assorted Box of Fibre Washers - Metric

DIN 7603A.

Part No. Box of

AB143 600 Pieces

8 x Sizes: M5 x 9 x 1.0, M6 x 10 x 1.0, M8 x 12 x 1.0, M10 x 14 x 1.0, M12 x 18 x 1.5, M14 x 20 x 1.5, M16 x 22 x 1.5, M18 x 24 x 1.5.



Fibre Washers - Imperial

WS 010.

Part No.	Pack of	I.D. x O.D. x Thickness
HFB31	100	13/64" x 3/8" x 1/16"
HFB32	100	1/4" x 3/8" x 1/16"
HFB33	100	5/16" x 5/8" x 1/16"
HFB34	100	3/8" x 5/8" x 1/16
HFB35	100	29/64" x 11/16" x 1/16
HFB36	100	1/2" x 11/16" x 1/16
HFB37	100	5/8" x 7/8" x 1/16
HFB38	100	49/64" x 1" x 1/16

Assorted Box of Fibre Washers - Imperial

WS 010.

Part No. Box of

AB25N 600 Pieces

8 x Sizes: 13/64" x 3/8", 1/4" x 3/8", 5/16" x 5/8", 3/8" x 5/8", 29/64" x 11/16", 1/2" x 11/16", 5/8" x 7/8", 49/64" x 1".



Aluminium Washers - Metric

DIN 7603A

Part No.	Pack of	I.D. x O.D. x Thickness
HAW610	100	M6 x 10 x 1.0
HAW811	100	M8 x 11 x 1.0
HAW1013	100	M10 x 13 x 1.0
HAW1014	100	M10 x 14 x 1.0
HAW1216	100	M12 x 16 x 1.5
HAW1218	100	M12 x 18 x 1.5
HAW1418	100	M14 x 18 x 1.5
HAW1420	100	M14 x 20 x 1.5
HAW1620	100	M16 x 20 x 1.5
HAW1721	100	M17 x 21 x 1.5
HAW2227	100	M22 x 27 x 1.0

Assorted Box of Aluminium Washers - Metric

DIN 7603A.

Part No. Box of

AB149 260 Pieces

11 x Sizes: M6 x 10, M8 x 11, M10 x 13, M10 x 14, M12 x 16, M12 x 18, M14 x 18, M14 x 20, M16 x 20, M17 x 21, M22 x 27.



Copper Compression Washers - Metric

Oval section.

Part No.	Pack of	I.D. x O.D. x Thickness
HCC610	100	6 x 10 x 1.5 mm
HCC812	100	8 x 12 x 1.5 mm
HCC1014	100	10 x 14 x 1.5 mm
HCC1218	50	12 x 18 x 2.0 mm
HSU10	50	14 x 20 x 2.0 mm
HSU11	50	16 x 22 x 2.0 mm
HSU12	50	18 x 24 x 2.0 mm
HCC2026	50	20 x 26 x 2.0 mm
HCC2227	50	22 x 27 x 2.0 mm
HCC2632	50	26 x 32 x 2.5 mm



Copper Sealing Washers - Metric

DIN 7603A.

Part No.	Pack of	I.D. x O.D. x Thickness
HCU509	100	M5 x 9 x 1.0
HCU610	100	M6 x 10 x 1.0
HCU612	100	M6 x 12 x 1.0
HCU609	100	M6.5 x 9.5 x 1.0
HCU811	100	M8 x 11.5 x 1.0
HCU812	100	M8 x 12 x 1.0
HCU814	100	M8 x 14 x 1.0
HCU914	100	M9 x 14 x 1.0
HCU1013	100	M10 x 13.5 x 1.0
HCU1014	100	M10 x 14 x 1.0
HCU1016	100	M10 x 16 x 1.0
HCU10165	100	M10 x 16 x 1.5
HCU1021	100	M10 x 21 x 1.0
HCU1117	50	M11 x 17 x 1.5
HCU1216	100	M12 x 16 x 1.5
HCU1218	100	M12 x 18 x 1.5
HCU1318	50	M13 x 18 x 1.5
HCU14180	50	M14 x 18 x 1.0
HCU1418	100	M14 x 18 x 1.5
HCU1420	100	M14 x 20 x 1.5
HCU1520	50	M15 x 20 x 2.0
HCU1620	100	M16 x 20 x 1.5
HCU1622	100	M16 x 22 x 1.5
HCU1624	50	M16 x 24 x 1.5
HCU1721	50	M17 x 21 x 1.5
HCU1723	50	M17 x 23 x 1.5
HCU1725	50	M17.5 x 25 x 2.0
HCU1822	100	M18 x 22 x 1.5
HCU1824	100	M18 x 24 x 1.5
HCU2026	100	M20 x 26 x 1.5
HCU2024	50	M20 x 24 x 1.5
HCU2125	100	M21 x 25 x 1.0
HCU2227	50	M22 x 27 x 1.5
HCU2430	100	M24 x 30 x 2.0
HCU2634	50	M26 x 34 x 2.0
HCU2834	25	M28 x 34 x 2.0
HCU3038	25	M30 x 38 x 2.0
HCU3240	25	M32 x 40 x 2.0
HCU3545	25	M35 x 45 x 2.0

Assorted Box of Copper Sealing Washers - Metric

DIN 7603A.

Part No.	Box of
AB106	250 Pieces

16 x Sizes: M5 x 9 x 1.0, M6 x 10 x 1.0, M6 x 12 x 1.0, M8 x 12 x 1.0, M8 x 14 x 1.0, M10 x 14 x 1.0, M10 x 16 x 1.0, M12 x 16 x 1.5, M12 x 18 x 1.5, M14 x 18 x 1.5, M14 x 20 x 1.5, M16 x 20 x 1.5, M16 x 22 x 1.5, M18 x 22 x 1.5, M18 x 24 x 1.5, M20 x 26 x 1.5 mm.



Copper Sealing Washers - Imperial/BSP

Part No.	Pack of	I.D. x O.D. x Thickness	Size
HCU23	100	.265 x .375 x 20g	1/4"
HCU24	100	.265 x .437 x 20g	1/4"
HCU25	100	.265 x .500 x 20g	1/4"
HCU34	100	.323 x .437 x 20g	5/16"
HCU35	100	.323 x .500 x 20g	5/16"
HCU46	100	.390 x .590 x 20g	(3/8") 1/8" BSP
HCU48	100	.390 x .590 x 18g	(3/8") 1/8" BSP
HCU57	100	.530 x .720 x 20g	1/4" BSP
HCU58	100	.530 x .750 x 18g	1/4" BSP
HCU68	100	.665 x .875 x 18g	(21/32") 3/8" BSP
HCU80	100	.830 x 1.00 x 18g	(13/16") 1/2" BSP
HCU81	100	.830 x 1.04 x 18g	(13/16") 1/2" BSP
HCU91	100	.910 x 1.13 x 16g	(29/32") 5/8" BSP
HCU93	100	1.05 x 1.32 x 16g	3/4" BSP
HCU95	100	1.20 x 1.50 x 16g	7/8" BSP
HCU96	100	1.32 x 1.62 x 16g	(1 5/16") 1" BSP

Assorted Box of Copper Sealing Washers - Imperial/BSP

Part No.	Box of
AB23	225 Pieces

16 x Sizes: 1/4" (265 x .375 x 20g), 1/4" (265 x .437 x 20g), 1/4" (265 x .500 x 20g), 5/16" (.323 x .437 x 20g), 5/16" (.323 x .500 x 20g), 1/8" BSP (3/8") (.390 x .590 x 20g), 1/8" BSP (3/8") (.390 x .590 x 18g), 1/4" BSP (.530 x .720 x 20g), 1/4" BSP (.530 x .750 x 18g), 3/8" BSP (21/32") (.665 x .875 x 18g), 1/2" BSP (13/16") (.830 x 1.00 x 18g), 1/2" BSP (13/16") (.830 x 1.04 x 18g), 5/8" BSP (29/32") (.910 x 1.13 x 16g), 3/4" BSP (1.05 x 1.32 x 16g), 7/8" BSP (1.20 x 1.50 x 16g), 1" BSP (1.32 x 1.62 x 16g).



'Max Box' Assortment of Copper Sealing Washers - Metric

DIN 7603A.

Part No.	Box of
AB505	1,050 Pieces

16 Sizes: M5 x 9 x 1.0, M6 x 10 x 1.0, M6 x 12 x 1.0, M8 x 12 x 1.0, M8 x 14 x 1.0, M10 x 14 x 1.0, M10 x 16 x 1.0, M12 x 16 x 1.5, M12 x 18 x 1.5, M14 x 18 x 1.5, M14 x 20 x 1.5, M16 x 20 x 1.5, M16 x 22 x 1.5, M18 x 22 x 1.5, M18 x 24 x 1.5, M20 x 26 x 1.5 mm.



Bonded Seals (Dowty Washers) - Metric

Metal with black nitrile rubber (NBR). Self centralising.

Part No.	Pack of	Size	Centralising Lip I.D.
HSL10	50	M10	8.05 mm
HSL12	50	M12	9.73 mm
HSL14	50	M14	11.38 mm
HSL16	50	M16	13.41 mm
HSL18	50	M18	14.76 mm
HSL20	50	M20	16.76 mm
HSL22	25	M22	18.74 mm
HSL24	25	M24	20.11 mm



Bonded Seals (Dowty Washers) - BSP

Metal with black nitrile rubber (NBR). Self centralising.

Part No.	Pack of	Size	Centralising Lip I.D.
HSL41	50	1/8" BSP	8.26 mm
HSL42	50	1/4" BSP	11.18 mm
HSL43	50	3/8" BSP	14.76 mm
HSL44	50	1/2" BSP	18.24 mm
HSL45	25	5/8" BSP	20.27 mm
HSL46	25	3/4" BSP	23.83 mm
HSL48	25	1" BSP	29.92 mm



Assorted Box of Bonded Seals (Dowty Washers) - Metric

Metal with black nitrile rubber (NBR). Self centralising.

Part No.	Box of
AB107	90 Pieces

8 x Sizes: M10, M12, M14, M16, M18, M20, M22, M24.



Assorted Box of Bonded Seals (Dowty Washers) - BSP

Metal with black nitrile rubber (NBR). Self centralising.

Part No.	Box of
AB67N	100 Pieces

7 x Sizes: 1/8" BSP, 1/4" BSP, 3/8" BSP, 1/2" BSP, 5/8" BSP, 3/4" BSP, 1" BSP.



Assorted Box of Copper Sealing Washers (Diesel Injector Washers)

Copper. DIN 7603A.

Part No.	Box of
AB142	250 Pieces

16 x Sizes: M6 x 10 x 1.0 (BOSCH 2916 710 602), M8 x 11.5 x 1.0 (LUCAS NW5-17W4, BOSCH 2916 710 646), M10 x 13.5 x 1.0 (BOSCH 2916 710 605), M10 x 14 x 1.0 (BOSCH 2916 710 649), M10 x 20 x 1.0 (MAN/PERKINS P:2411126), M10 x 20 x 2.0 (LUCAS 5339401, PERKINS P:0920113), M12 x 16 x 1.5 (BOSCH 2916 710 607), M12 x 18 x 1.5 (BOSCH 2916 710 608), M14 x 18 x 1.5 (BOSCH 2916 710 609), M14 x 20 x 1.5 (BOSCH 2916 710 610), M16 x 20 x 1.5 (BOSCH 2916 710 611), M17 x 21 x 1.5 (BOSCH 2916 710 611, GM 14025557), M21 x 25 x 1.0 (LUCAS NW5/59), M22 x 27 x 1.0 (LUCAS NW5/60).

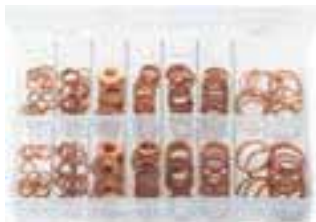

Air Conditioning O-Rings Kit

Highly saturated nitrile O-rings for use with Freon R134a. Supplied in a hinged plastic case.

Part No.	Description
HAC200	270 Piece Kit

18 x Sizes (I.D. x Thickness):
 5.29 x 1.78 (7/32" x 1/16"), (1/4" x 1/16"),
 6.07 x 1.78, 6.8 x 1.9, 7.65 x 1.78 (5/16" x 1/16"),
 7.8 x 1.9, 8 x 2, 8.8 x 1.9 (20 pcs),
 10.82 x 1.78 (7/16" x 1/16"),
 10.77 x 2.62 (7/16" x 3/32"), 11 x 2, 12 x 2 (15 pcs),
 13.9 x 1.8, 13.95 x 2.62 (9/16" x 3/32"), 14 x 2, 15 x 2,
 17 x 2, 17.17 x 1.78 (11/16" x 1/16"),
 17.04 x 3.53 mm (11/16" x 1/8") (10 pcs).



Copper Compression Washers - Metric

Oval section.

Part No.	Pack of	I.D. x O.D. x Thickness
HCC610	100	6 x 10 x 1.5 mm
HCC812	100	8 x 12 x 1.5 mm
HCC1014	100	10 x 14 x 1.5 mm
HCC1218	50	12 x 18 x 2.0 mm
HSU10	50	14 x 20 x 2.0 mm
HSU11	50	16 x 22 x 2.0 mm
HSU12	50	18 x 24 x 2.0 mm
HCC2026	50	20 x 26 x 2.0 mm
HCC2227	50	22 x 27 x 2.0 mm
HCC2632	50	26 x 32 x 2.5 mm



Sump Plug Washers



BEST SELLER

Copper Compression Washers

Part No. Pack of I.D. x O.D. x Thickness

HSU45 50 12 x 17 x 2.0 mm

Suits TOYOTA Auris, Avensis, Camry, Carina, Celica, Corolla, Corona, Hiace, Hilux, Land Cruiser, Prius, Rav 4, Starlet, Supra, Yaris.



BEST SELLER

Flat Copper Washers

Part No. Pack of I.D. x O.D. x Thickness

HSU1022 50 10 x 20 x 2.0 mm

Suits CITROËN Berlingo, C1, C2, C3, C4, C5, C6, Xantia, Xsara. FIAT Scudo. MINI R56, R55, Clubman. PEUGEOT 107, 206, 207, 306, 307, 308, 406, 407, 607, 806, 807, 1007, 4007, Bipper, Expert, Partner. TOYOTA Aygo, Corolla. VOLVO C30, S40 II, V50.



BEST SELLER

Flat Copper Washers

Part No. Pack of I.D. x O.D. x Thickness

HSU14 50 14 x 20 x 2.0 mm

Suits VAUXHALL, VW (Except Beetle).



BEST SELLER

Copper Compression Washers

Part No. Pack of I.D. x O.D. x Thickness

HSU10 50 14 x 20 x 2.0 mm

Suits CITROËN (9/93->), PEUGEOT (9/93->).



Flat Copper Washers

Part No. Pack of I.D. x O.D. x Thickness

HSU1217 50 12 x 17 x 1.5 mm

Suits BMW Series 1, 3, 5, 6, 7, X3, X5, X6, Z1, Z3, Z4.



Flat Copper Washers

Part No. Pack of I.D. x O.D. x Thickness

HSU26 50 16.3 x 25.4 x 2.0 mm

Suits ROVER Mini, Metro & 100 Series.



BEST SELLER

Copper Compression Washers

Part No. Pack of I.D. x O.D. x Thickness

HSU11 50 16 x 22 x 2.0 mm

Suits CITROËN (<9/93), PEUGEOT (<9/93), RENAULT 5, FIAT (Diesel), ROVER (Diesel).



Flat Copper Washers

Part No. Pack of I.D. x O.D. x Thickness

HSU27 50 14 x 19 x 2.0 mm

Suits ROVER (Non-HONDA Engines inc. K Series, Except Diesel & Mini A Series).



Flat Copper Washers

Part No. Pack of I.D. x O.D. x Thickness

HSU1826 50 18 x 26 x 1.5 mm

Suits ALFA ROMEO 145, 146, 147, 155, 156, 159, 166, Brera, GT, GTV, Spider. FIAT Brava, Bravo, Coupe, Doblo, Idea, Mera, Multipla, Stilo, Strada. LANCIA Delta, Kappa, Lybra, Musa, Thesis. SUZUKI SX4.



Copper Compression Washers

Part No. Pack of I.D. x O.D. x Thickness

HSU12 50 18 x 24 x 2.0 mm

Suits RENAULT (Except RENAULT 5).



Flat Copper Washers

Part No. Pack of I.D. x O.D. x Thickness

HSU1420 50 14 x 20 x 1.5 mm

Suits VAUXHALL Astra, Cavalier, Combo, Corsa, Corsavan, Nova. OPEL/VAUXHALL Ascona, Astra, Calibra, Carlton, Cavalier, Corsa, Frontera, Kadett, Manta, Nova, Omega, Rekord, Senator, Tigra, Vectra, Zafira. CHRYSLER 300 C, PT Cruiser, Voyager. MERCEDES Klasse A, B, CE, G, V, GL, MSL, SLK, Sprinter, T1, Vaneo, Vito. AUDI 80, 90, 100, 200, A4, A6, A8, Quattro. SEAT Ibiza, Inca. SKODA Fabia, Felicia. VW Caddy, Fox, Golf I.



Flat Copper Washers

Part No. Pack of I.D. x O.D. x Thickness

HSU35 50 19 x 26 x 2.0 mm

Suits VOLVO (Other than 3 Series).



Looking for Sump Plugs?

Our Sump Plug range starts on Page 259



PLEASE NOTE:
Vehicle listings for sump plugs are for guidance only

BEST SELLER

Nitrile Rubber O-Rings

Part No.	Pack of	I.D. x Thickness
HSU50	50	18 x 2 NBR

Suits VAUXHALL Astra F G H, Combo, Corsa B C D, Vectra B C.



Aluminium Washers

Part No.	Pack of	I.D. x O.D. x Thickness
HSU1215	50	12 x 15 x 1.5 mm

Suits BMW Series 1, 3, 5, 6, 7, X3, X5, X6, Z1, Z3, Z4.

BEST SELLER

Fibre Washers

Part No.	Pack of	I.D. x O.D. x Thickness
HSU40	50	12 x 24 x 2.0 mm

Suits TOYOTA Auris, Avensis, Camry, Carina, Celica, Corolla, Corona, Hiace, Hilux, Land Cruiser, Prius, Rav 4, Starlet, Supra, Yaris.



Flanged Rubber O-Rings

Part No.	Pack of	I.D. x O.D. x Thickness
HSU60	50	11 x 21 x 2.5 mm

Suits VAUXHALL Astra G, Omega B, Signum, Vectra BC, Zafira.



Aluminium Washers

Part No.	Pack of	I.D. x O.D. x Thickness
HSU1217AL	50	12 x 17 x 1.5 mm

Suits BMW Series 1, 2, 3, 5, 7, 8, X5, Z4. MERCEDES 190, SL, CLK, T1, Klasse C, E, G, S. MINI One D.



Fibre Washers

Part No.	Pack of	I.D. x O.D. x Thickness
HSU41	50	18 x 29 x 2.0 mm

Suits TOYOTA (Large Engines inc. Supra).

BEST SELLER

Flanged Rubber O-Rings

Part No.	Pack of	I.D. x O.D. x Thickness
HSU51	50	13 x 22 x 3.0 mm

Suits CHRYSLER 300, Caravan, Cirrus, Crossfire, Le Baron, Neo, PT Cruiser, Sebring, Stratus, Voyager. FORD C-Max, Cougar, Courier, Escort, Fiesta, Focus, C-Max Focus, Fusion, Galaxy, Ka, Maverick, Mondeo, Puma, S-Max, Transit.

BEST SELLER

Aluminium Washers

Part No.	Pack of	I.D. x O.D. x Thickness
HSU25	50	14 x 22 x 2.0 mm

Suits ROVER (All HONDA Engines), HONDA (New Models).

BEST SELLER

Bonded Seals

Part No.	Pack of	I.D. x O.D.
HSU21	50	16.7 x 24 mm

Suits FORD Mondeo (Zetec Engines). FORD Focus & KA.



Nylon Washers

Part No.	Pack of	I.D. x O.D. x Thickness
HSU19	50	13 x 20 x 2.0 mm

Suits FORD OHV.



Aluminium Washers

Part No.	Pack of	I.D. x O.D. x Thickness
HSU1824AL	50	18 x 24 x 1.5 mm

Suits VOLVO, PORSCHE.



Nylon Washers

Part No.	Pack of	I.D. x O.D. x Thickness
HSU20	50	14.5 x 22 x 2.0 mm

Suits FORD OHC.



Aluminium Washers

Part No.	Pack of	I.D. x O.D. x Thickness
HSU30	50	22 x 27 x 1.5 mm

Suits FIAT (Except Diesel), MERCEDES (Some).

**BEST SELLER**

Sump Plug Washers

Part No.	Box of
----------	--------

AB117N 265 Pieces

4 x Copper Compression: 12 x 17 x 2.00, 14 x 20 x 2.0, 16 x 22 x 2.0, 18 x 24 x 2.0 mm.
 4 x Flat Copper: 10 x 20 x 2.00, 12 x 17 x 1.5, 14 x 20 x 1.5, 14 x 20 x 2.0 mm.
 2 x Aluminium: 14 x 22 x 2.0, 18 x 24 x 1.5 mm.
 2 x Flanged Rubber O-ring: 11 x 21 2.5, 13 x 22 x 3.0 mm.
 1 x Nitrile Rubber O-Ring: 18 x 2 NBR.
 1 x Fibre: 12 x 24 x 2.0 mm.
 1 x Bonded Seal: 16.7 x 24 mm.





O-Rings - Imperial

Nitrile rubber. BS 1806.

Part No.	Pack of	I.D. x Thickness	ARP/BS
AB101/1	100	2.90 x 1.78 mm	006
AB101/4	100	5.28 x 1.78 mm	009
AB101/5	100	6.07 x 1.78 mm	010
AB101/6	100	7.66 x 1.78 mm	011
AB101/8	100	9.19 x 2.62 mm	110
AB101/9	100	10.78 x 2.62 mm	111
AB101/10	100	12.37 x 2.62 mm	112
AB101/16	100	20.22 x 3.53 mm	211
AB101/17	100	21.82 x 3.53 mm	212
AB101/20	100	26.58 x 3.53 mm	215
AB101/21	100	28.17 x 3.53 mm	216
AB101/22	100	29.75 x 3.53 mm	217
AB101/23	100	31.34 x 3.53 mm	218
AB101/24	100	32.92 x 3.53 mm	219
AB101/25	100	34.52 x 3.53 mm	220
AB101/26	100	36.10 x 3.53 mm	221
AB101/27	100	37.69 x 3.53 mm	222
AB101/28	100	37.47 x 5.33 mm	325
AB101/29	100	40.65 x 5.33 mm	326
AB101/30	100	43.82 x 5.33 mm	327

O-Rings Service Kit - Imperial

Nitrile rubber. BS 1806.

Part No. Box of

AB101 382 Pieces

30 x Sizes (ARP/BS) I.D. x Thickness: 2.90 x 1.78 (006), 3.68 x 1.78 (007), 4.48 x 1.78 (008), 5.28 x 1.78 (009), 6.07 x 1.78 (010), 7.66 x 1.78 (011), 9.25 x 1.78 (012), 9.19 x 2.62 (110), 10.78 x 2.62 (111), 12.37 x 2.62 (112), 13.95 x 2.62 (113), 15.54 x 2.62 (114), 17.13 x 2.62 (115), 18.72 x 2.62 (116), 18.64 x 3.53 (210), 20.22 x 3.53 (211), 21.82 x 3.53 (212), 23.40 x 3.53 (213), 24.99 x 3.53 (214), 26.58 x 3.53 (215), 28.17 x 3.53 (216), 29.75 x 3.53 (217), 31.34 x 3.53 (218), 32.92 x 3.53 (219), 34.52 x 3.53 (220), 36.10 x 3.53 (221), 37.69 x 3.53 (222), 37.47 x 5.33 (325), 40.65 x 5.33 (326), 43.82 x 5.33 (327).



O-Rings Service Kit - Metric

Nitrile rubber. BS 4518.

Part No. Box of

AB100 404 Pieces

30 x Sizes (Peg Ref) I.D. x Thickness: 3 x 2 (006), 4 x 2 (007), 5 x 2 (008), 6 x 2 (009), 7 x 2 (010), 8 x 2 (011), 10 x 2 (012), 10 x 2.5 (110), 11 x 2.5 (111), 12 x 2.5 (112), 14 x 2.5 (113), 16 x 2.5 (114), 17 x 2.5 (115), 19 x 2.5 (116), 19 x 3 (210), 20 x 3 (211), 22 x 3 (212), 24 x 3 (213), 25 x 3 (214), 27 x 3 (215), 28 x 3 (216), 30 x 3 (217), 32 x 3 (218), 33 x 3 (219), 35 x 3 (220), 36 x 3 (221), 38 x 3 (222), 38 x 4 (325), 41 x 4 (326), 44 x 4 mm (327).



O-Rings - Metric

Nitrile rubber. BS 4518.

Part No.	Pack of	I.D. x Thickness	Peg No.
AB100/1	100	3 x 2 mm	006
AB100/2	100	4 x 2 mm	007
AB100/3	100	5 x 2 mm	008
AB100/4	100	6 x 2 mm	009
AB100/5	100	7 x 2 mm	010
AB100/6	100	8 x 2 mm	011
AB100/7	100	10 x 2 mm	012
AB100/8	100	10 x 2.5 mm	110
AB100/9	100	11 x 2.5 mm	111
AB100/10	100	12 x 2.5 mm	112
AB100/11	100	14 x 2.5 mm	113
AB100/12	100	16 x 2.5 mm	114
AB100/13	100	17 x 2.5 mm	115
AB100/14	100	19 x 2.5 mm	116
AB100/15	100	19 x 3 mm	210
AB100/16	100	20 x 3 mm	211
AB100/17	100	22 x 3 mm	212
AB100/18	100	24 x 3 mm	213
AB100/19	100	25 x 3 mm	214
AB100/20	100	27 x 3 mm	215
AB100/21	100	28 x 3 mm	216
AB100/22	100	30 x 3 mm	217
AB100/23	100	32 x 3 mm	218
AB100/24	100	33 x 3 mm	219
AB100/25	100	35 x 3 mm	220
AB100/26	100	36 x 3 mm	221
AB100/27	100	38 x 3 mm	222
AB100/28	100	38 x 4 mm	325
AB100/29	100	42 x 4 mm	326
AB100/30	100	45 x 4 mm	327

Assorted Box of O-Rings - Imperial

Nitrile rubber. BS 1806.

Part No. Box of

AB61 325 Pieces

10 x ARP/BS: 008, 010, 011, 012, 013, 014, 016, 116, 118, 120.



Assorted Box of O-Rings - Metric

Nitrile rubber. BS 4518.

Part No. Box of

AB81 325 Pieces

4 x I.D. x Thickness: 4.1 x 1.6, 6.1 x 1.6, 10.1 x 1.6, 12.1 x 1.6.
4 x I.D. x Thickness: 7.6 x 2.4, 9.6 x 2.4, 11.6 x 2.4, 12.6 x 2.4
2 x I.D. x Thickness: 19.5 x 3.0, 24.5 x 3.0.



O-Ring Splicing Kit

Nitrile rubber.

Part No. Description

AB126 14 Piece Kit

5 x Imperial Nitrile Rubber Cord, 1 m Lengths: 1/16", 3/32", 1/8", 3/16", 1/4".
6 x Metric Nitrile Rubber Cord, 1 m Lengths: 1.6, 2, 3, 4, 5, 5.7 mm.
1 x Trimming Knife. 1 x Cutting Block.
1 x S-A-S Super Glue: 5g.





140

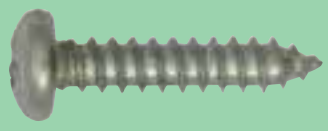

142



144



145



146



148



**Hardware +
Trim Clips**



150



152



154

- 140 Number Plate Screws
- 142 Self Tapping Screws
- 145 Self Drilling Screws
- 145 Sheet Metal Screws
- 146 Body Sems Screws
- 148 Speed Nuts
- 150 Spring Fasteners
- 150 Spring Clips
- 151 Rivets
- 154 Rivet Tools
- 156 Clips + Pins
- 160 Steel Stock
- 162 Trim Buttons
- 164 Fir-Tree Fixings
- 165 Push Rivets
- 168 Drive Rivets
- 170 Screw-Type Rivets
- 174 Locking Nuts
- 175 Grommets
- 176 Panel Clips
- 179 Side Moulding Clips
- 180 Miscellaneous Clips
- 182 Pipe + Rod Clips
- 184 Trim Rivets
- 185 Trim Clips by OEM Ref
- Vehicle Marque



156



158



158

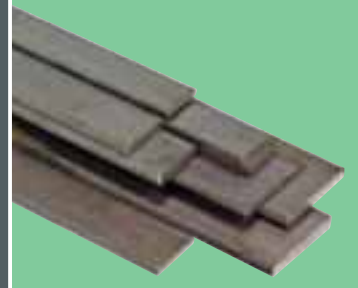

160



163



164



172





Number Plate Fasteners - Self-Tappers with Plastic Head - Long



Part No.	Pack of	Colour	Size
NP10	100	White	4.8 x 24 mm
NP11	100	Yellow	4.8 x 24 mm
NP12	100	Black	4.8 x 24 mm
NP21	100	Blue	4.8 x 24 mm
NP40	100	Green	4.8 x 24 mm



Number Plate Fasteners - Plastic Number Plate Bolts & Nuts - Long



Part No.	Pack of	Colour	Size
NP24	100 Pairs	No. Plate White	6 x 22 mm
NP25	100 Pairs	Yellow	6 x 22 mm
NP26	100 Pairs	Black	6 x 22 mm



Number Plate Fasteners - Self-Tappers with Plastic Head - Short



Part No.	Pack of	Colour	Size
NP16	100	White	4.8 x 18 mm
NP17	100	Yellow	4.8 x 18 mm
NP18	100	Black	4.8 x 18 mm
NP20	100	Blue	4.8 x 18 mm
NP39	100	Green	4.8 x 18 mm



Number Plate Fasteners - Plastic Number Plate Bolts & Nuts - Short



Part No.	Pack of	Colour	Size
NP1	100 Pairs	No. Plate White	6 x 18 mm
NP2	100 Pairs	Yellow	6 x 18 mm
NP5	100 Pairs	Black	6 x 18 mm

Assorted Box of Number Plate Fasteners with Plastic Head - Short

Self tapping screws with plastic head, 4.8 x 18 mm.

Part No.	Box of
AB184	260 Pieces

4 x Colours: White, Yellow, Black, Blue.



Assorted Box of Number Plate Fasteners

White, Yellow, Black.

Part No.	Box of
AB62	240 Pairs

1 x Self-Tapping Screw, Pan Head - Poz: 8 x 3/4" (4.9 x 19 mm).
 3 x Hinged Caps: White, Yellow, Black.
 3 x Plastic Bolts & Nuts: White, Yellow, Black.





Number Plate Fasteners - Self-Tappers with Domes and Cups

No. 8 x 3/4" (4.2 x 19mm) Pan Head - Pozi.

Part No.	Pack of	Colour	Size
NP7	100 Sets	White	4.2 x 19 mm
NP8	100 Sets	Yellow	4.2 x 19 mm
NP9	100 Sets	Black	4.2 x 19 mm
NP22	100 Sets	Blue	4.2 x 19 mm

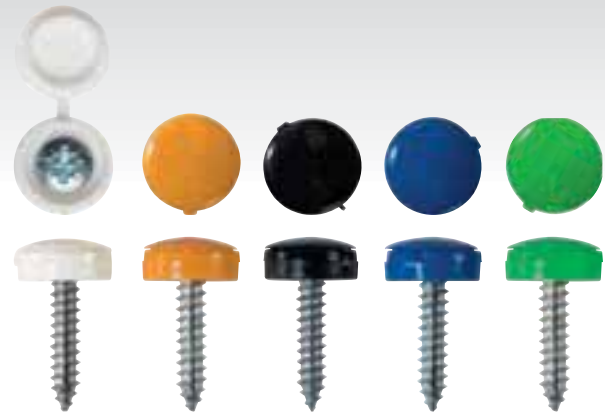

Number Plate Fasteners - Self-Tappers with Hinged Caps

No. 8 x 3/4" (4.2 x 19mm) Pan Head - Pozi.

Part No.	Pack of	Colour	Size
NP3	100 Pairs	White	4.2 x 19 mm
NP4	100 Pairs	Yellow	4.2 x 19 mm
NP6	100 Pairs	Black	4.2 x 19 mm
NP19	100 Pairs	Blue	4.2 x 19 mm
NP37	100 Pairs	Green	4.2 x 19 mm



Number Plate Fasteners - Domes & Cups

Can be used with Pan Head Pozi Self-Tapping Screw - No. 8.

Part No.	Pack of	Colour
NP13	100 Pairs	White
NP14	100 Pairs	Yellow
NP15	100 Pairs	Black
NP23	100 Pairs	Blue



Double-Sided Adhesive Pads - Number Plate Pads

Part No.	Pack of	Size
VC401	20 x 3	80 x 25 mm



Security Number Plate Fasteners - Self-Tappers with Hinged Caps

No. 8 x 3/4" (4.2 x 19mm) Pan Head - Slotted One Way/Clutch Head Screws (Tamperproof).

Part No.	Pack of	Colour	Size
NP33	100 Pairs	White	4.2 x 19 mm
NP34	100 Pairs	Yellow	4.2 x 19 mm
NP35	100 Pairs	Black	4.2 x 19 mm
NP36	100 Pairs	Blue	4.2 x 19 mm
NP38	100 Pairs	Green	4.2 x 19 mm



Assorted Box of Security Number Plate Fasteners

Slotted One Way/Clutch Head Screws (Tamperproof).

Part No.	Box of
AB222	200 Pieces

1 x Self-Tapping Screw, Pan-Head - One-Way: 8 x 3/4" (4.9 x 19 mm).
4 x Hinged Caps: White, Yellow, Black, Blue.





Self-Tapping Screws Pan Head - Pozi

AB Type. Zinc plated steel. DIN 7981/C/Z.

Part No.	Pack of	Gauge x Length	Size x Length
HTP4/4	200	4 x 1/2"	2.9 x 13 mm
HTP4/6	200	4 x 3/4"	2.9 x 19 mm
HTP6/4	200	6 x 1/2"	3.5 x 13 mm
HTP6/5	200	6 x 5/8"	3.5 x 16 mm
HTP6/6	200	6 x 3/4"	3.5 x 19 mm
HTP6/8	200	6 x 1"	3.5 x 25 mm
HTP6/10	200	6 x 1 1/4"	3.5 x 32 mm
HTP8/4	200	8 x 1/2"	4.2 x 13 mm
HTP8/5	200	8 x 5/8"	4.2 x 16 mm
HTP8/6	200	8 x 3/4"	4.2 x 19 mm
HTP8/8	200	8 x 1"	4.2 x 25 mm
HTP8/12	100	8 x 1 1/2"	4.2 x 38 mm
HTP10/4	200	10 x 1/2"	4.8 x 13 mm
HTP10/5	200	10 x 5/8"	4.8 x 16 mm
HTP10/6	200	10 x 3/4"	4.8 x 19 mm
HTP10/8	200	10 x 1"	4.8 x 25 mm
HTP10/10	200	10 x 1 1/4"	4.8 x 32 mm
HTP10/12	200	10 x 1 1/2"	4.8 x 38 mm
HTP12/4	200	12 x 1/2"	5.5 x 13 mm
HTP12/6	200	12 x 3/4"	5.5 x 19 mm
HTP12/8	200	12 x 1"	5.5 x 25 mm
HTP12/12	200	12 x 1 1/2"	5.5 x 38 mm
HTP12/16	100	12 x 2"	5.5 x 51 mm
HTP12/24	100	12 x 3"	5.5 x 76 mm
HTP14/6	100	14 x 3/4"	6.3 x 19 mm
HTP14/8	200	14 x 1"	6.3 x 25 mm
HTP14/12	200	14 x 1 1/2"	6.3 x 38 mm

Assorted Box of Self-Tapping Screws Pan Head - Pozi (Small Sizes)

AB Type. Zinc plated steel. DIN 7981/C/Z.

Part No.	Box of
AB2	700 Pieces
1 x No. 4: x 1/2"; 2 x No. 6: x 1/2", 3/4"; 3 x No. 8: x 1/2", 3/4", 1"; 3 x No. 10: x 1/2", 3/4", 1"; 2 x No. 12: x 3/4", 1".	



Assorted Box of Self-Tapping Screws Pan Head - Pozi (Large Sizes)

AB Type. Zinc plated steel. DIN 7981/C/Z.

Part No.	Box of
AB94	300 Pieces
4 x No. 10: x 1/2", 3/4", 1", 1 1/2"; 3 x No. 12: x 3/4", 1", 1 1/2"; 2 x No. 14: x 1", 1 1/2".	



Stainless Steel Self-Tapping Screws Pan Head - Pozi

AB Type. Stainless Steel. DIN 7981 Grade A2.

Part No.	Pack of	Gauge x Length	Size x Length
HTA6/4	200	6 x 1/2"	3.5 x 13 mm
HTA6/6	200	6 x 3/4"	3.5 x 19 mm
HTA6/8	200	6 x 1"	3.5 x 25 mm
HTA8/4	200	8 x 1/2"	4.2 x 13 mm
HTA8/6	200	8 x 3/4"	4.2 x 19 mm
HTA8/8	200	8 x 1"	4.2 x 25 mm
HTA10/4	200	10 x 1/2"	4.8 x 13 mm
HTA10/6	200	10 x 3/4"	4.8 x 19 mm
HTA10/8	200	10 x 1"	4.8 x 25 mm

Assorted Box of Stainless Steel Self-Tapping Screws Pan Head - Pozi

AB Type. Stainless Steel. DIN 7981 Grade A2.

Part No.	Box of
AB141	450 Pieces
3 x No. 6: x 1/2", 3/4", 1"; 3 x No. 8: x 1/2", 3/4", 1"; 3 x No. 10: x 1/2", 3/4", 1".	

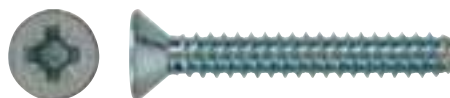

Self-Tapping Screws (Floorboards/Decking) Countersunk Head - Pozi

B Type. Zinc plated steel. DIN 7982/F/Z.

Part No.	Pack of	Gauge x Length	Size x Length
HTC14/12	200	14 x 1 1/2"	6.3 x 38 mm
HTC14/14	200	14 x 1 3/4"	6.3 x 44 mm
HTC14/16	200	14 x 2"	6.3 x 51 mm

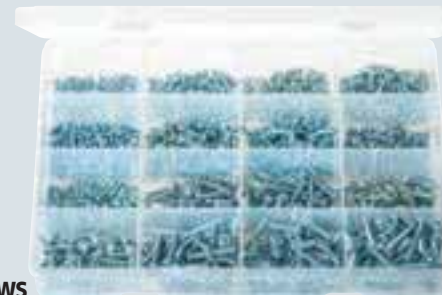

'Max Box' Assortment of Self-Tapping Screws Pan Head - Pozi

AB Type. Zinc plated steel. DIN 7981/C/Z.

Part No.	Box of
AB507	1,150 Pieces
1 x No. 4: x 1/2"; 3 x No. 6: x 1/2", 3/4", 1"; 3 x No. 8: x 1/2", 3/4", 1"; 4 x No. 10: x 1/2", 3/4", 1", 1 1/2"; 3 x No. 12: x 3/4", 1", 1 1/2"; 2 x No. 14: x 1", 1 1/2".	



Self-Tapping Screws Countersunk Head - Pozi

AB Type. Zinc plated steel. DIN 7982/C/Z.

Part No.	Pack of	Gauge x Length	Size x Length
HTC4/4	200	4 x 1/2"	2.9 x 13 mm
HTC4/6	200	4 x 3/4"	2.9 x 19 mm
HTC6/4	200	6 x 1/2"	3.5 x 13 mm
HTC6/5	200	6 x 5/8"	3.5 x 16 mm
HTC6/6	200	6 x 3/4"	3.5 x 19 mm
HTC6/8	200	6 x 1"	3.5 x 25 mm
HTC6/10	200	6 x 1 1/4"	3.5 x 32 mm
HTC6/12	200	6 x 1 1/2"	3.5 x 38 mm
HTC8/4	200	8 x 1/2"	4.2 x 13 mm
HTC8/5	200	8 x 5/8"	4.2 x 16 mm
HTC8/6	200	8 x 3/4"	4.2 x 19 mm
HTC8/8	200	8 x 1"	4.2 x 25 mm
HTC8/12	200	8 x 1 1/2"	4.2 x 38 mm
HTC8/16	200	8 x 2"	4.2 x 51 mm
HTC10/4	200	10 x 1/2"	4.8 x 13 mm
HTC10/5	200	10 x 5/8"	4.8 x 16 mm
HTC10/6	200	10 x 3/4"	4.8 x 19 mm
HTC10/8	200	10 x 1"	4.8 x 25 mm
HTC10/10	200	10 x 1 1/4"	4.8 x 32 mm
HTC10/12	200	10 x 1 1/2"	4.8 x 38 mm
HTC10/16	200	10 x 2"	4.8 x 51 mm
HTC12/6	100	12 x 3/4"	5.5 x 19 mm
HTC12/8	100	12 x 1"	5.5 x 25 mm
HTC12/12	100	12 x 1 1/2"	5.5 x 38 mm
HTC14/12A	200	14 x 1 1/2"	6.3 x 38 mm
HTC14/14A	200	14 x 1 3/4"	6.3 x 44 mm
HTC14/16A	200	14 x 2"	6.3 x 51 mm

Assorted Box of Self-Tapping Screws Countersunk - Pozi

AB Type. Zinc plated steel. DIN 7982/C/Z.

Part No.	Box of
AB63N	550 Pieces
4 x No. 6: x 5/8", 3/4", 1", 1 1/2".	
4 x No. 8: x 5/8", 3/4", 1", 1 1/2".	
4 x No. 10: x 5/8", 3/4", 1", 1 1/2".	



Assorted Pack of Plastic Wall Plugs

Part No.	Pack of
AP49	400 Pieces
3 x Colours: Yellow, Red, Brown.	



Multi-purpose Countersunk Screws - Pozi

Zinc plated steel. 3/4 thread

• Suitable for use with a variety of materials including wood.

Part No.	Pack of	Gauge x Length	Size x Length
HTW6/6	200	6 x 3/4"	3.5 x 19 mm
HTW6/8	200	6 x 1"	3.5 x 25 mm
HTW6/10	200	6 x 1 1/4"	3.5 x 32 mm
HTW6/12	200	6 x 1 1/2"	3.5 x 38 mm
HTW8/4	200	8 x 1/2"	4.2 x 13 mm
HTW8/6	200	8 x 3/4"	4.2 x 19 mm
HTW8/10	200	8 x 1 1/4"	4.2 x 32 mm
HTW8/12	200	8 x 1 1/2"	4.2 x 38 mm
HTW8/14	200	8 x 1 3/4"	4.2 x 44 mm
HTW8/16	200	8 x 2"	4.2 x 51 mm
HTW8/20	200	8 x 2 1/2"	4.2 x 63 mm
HTW8/24	200	8 x 3"	4.2 x 76 mm
HTW10/8	200	10 x 1"	4.8 x 25 mm
HTW10/12	200	10 x 1 1/2"	4.8 x 38 mm
HTW10/16	200	10 x 2"	4.8 x 51 mm
HTW10/20	200	10 x 2 1/2"	4.8 x 63 mm
HTW10/24	200	10 x 3"	4.8 x 76 mm
HTW12/8	100	12 x 1"	5.5 x 25 mm
HTW12/12	100	12 x 1 1/2"	5.5 x 38 mm
HTW12/24	100	12 x 3"	5.5 x 76 mm

Assorted Box of Multi-Use Screws Countersunk - Pozi

Zinc plated steel.

Part No.	Box of
AB140	525 Pieces
3 x No. 6: x 3/4", 1", 1 1/2".	
4 x No. 8: x 3/4", 1", 1 1/2", 2".	
3 x No. 10: x 1 1/2", 2", 2 1/2". 1 x No. 12: x 2".	



Looking for Screwdrivers or Bits?

Our full range of Screwdrivers and Bits start from Page 442





Self-Tapping Screws Flanged Head - Pozi Black

AB Type. Black zinc plated steel. BS 4174.

Part No.	Pack of	Gauge x Length	Size x Length
HTK6/3	200	6 x 3/8"	3.5 x 10 mm
HTK6/4	200	6 x 1/2"	3.5 x 13 mm
HTK6/5	200	6 x 5/8"	3.5 x 16 mm
HTK6/6	200	6 x 3/4"	3.5 x 19 mm
HTK6/8	200	6 x 1"	3.5 x 25 mm
HTK8/3	200	8 x 3/8"	4.2 x 10 mm
HTK8/4	200	8 x 1/2"	4.2 x 13 mm
HTK8/5	200	8 x 5/8"	4.2 x 16 mm
HTK8/6	200	8 x 3/4"	4.2 x 19 mm
HTK8/8	200	8 x 1"	4.2 x 25 mm
HTK8/10	100	8 x 1 1/4"	4.2 x 32 mm
HTK8/12	200	8 x 1 1/2"	4.2 x 38 mm
HTK10/3	200	10 x 3/8"	4.8 x 10 mm
HTK10/4	200	10 x 1/2"	4.8 x 13 mm
HTK10/5	200	10 x 5/8"	4.8 x 16 mm
HTK10/6	200	10 x 3/4"	4.8 x 19 mm
HTK10/8	200	10 x 1"	4.8 x 25 mm



Self-Tapping Screws Flanged Head - TORX® Black

AB Type. Black zinc plated steel. BS 4174.

Part No.	Pack of	Gauge x Length	Size x Length
HXT6/5	100	6 x 5/8"	3.5 x 16 mm
HXT7/6	100	7 x 3/4"	3.9 x 19 mm
HXT8/5	100	8 x 5/8"	4.2 x 16 mm
HXT8/6	100	8 x 3/4"	4.2 x 19 mm
HXT8/8	100	8 x 1"	4.2 x 25 mm
HXT10/5	100	10 x 5/8"	4.8 x 16 mm



Assorted Box of Self-Tapping Screws Flanged Pan Head - TORX® Black

AB Type. Black zinc plated steel. BS 4174.

Part No.	Box of
AB168N	450 Pieces
1 x No. 6: x 5/8", 1 x No. 7: x 3/4", 3 x No. 8: x 5/8", 3/4", 1", 1 x No. 10: x 5/8".	



Assorted Box of Self-Tapping Screws Flanged - Pozi Black

AB Type. Black zinc plated steel. BS 4174.

Part No.	Box of
AB71	700 Pieces
2 x No. 6: x 1/2", 3/4", 4 x No. 8: x 1/2", 3/4", 1", 1 1/2", 3 x No. 10: x 1/2", 3/4", 1".	



'Max Box' Assortment of Self-Tapping Screws Flanged Pan Head - Pozi

AB Type. Black zinc plated steel. BS 4174.

Part No.	Box of
AB506	1,250 Pieces
6 x No. 6: x 3/8", 1/2", 5/8", 3/4", 1", 3/8", 5 x No. 8: x 1/2", 5/8", 3/4", 1", 1 1/2", 4 x No. 10: x 1/2", 5/8", 3/4", 1".	

Self-Drill Fixings

Part No.	Pack of	Size
HCT8	50	MB



Assorted Pack of Plastic Wall Plugs

Part No.	Pack of
AP49	400 Pieces

3 x Colours: Yellow, Red, Brown.



Looking for Screwdrivers or Bits?

Our full range of Screwdrivers and Bits start from Page 442





Self-Drilling Screws - Hex Head

Zinc plated steel. DIN 7504K.

Part No.	Pack of	Gauge x Length	Size x Length
HHD8/4	200	8 x 1/2"	4.2 x 13 mm
HHD8/6	200	8 x 3/4"	4.2 x 19 mm
HHD8/8	200	8 x 1"	4.2 x 25 mm
HHD10/4	200	10 x 1/2"	4.8 x 13 mm
HHD10/6	200	10 x 3/4"	4.8 x 19 mm
HHD10/8	200	10 x 1"	4.8 x 25 mm
HHD12/8	200	12 x 1"	5.5 x 25 mm
HHD12/12	200	12 x 1 1/2"	5.5 x 38 mm
HHD12/16	200	12 x 2"	5.5 x 51 mm
HHD14/8	200	14 x 1"	6.3 x 25 mm
HHD14/12	200	14 x 1 1/2"	6.3 x 38 mm
HHD14/16	200	14 x 2"	6.3 x 51 mm

Assorted Box of Self-Drilling Screws Hex Head

Zinc plated steel. DIN 7504K.

Part No.	Box of
AB138	400 Pieces
3 x No. 8: x 1/2", 3/4", 1", 3 x No. 10: x 1/2", 3/4", 1".	
3 x No. 12: x 1", 1 1/2", 2".	

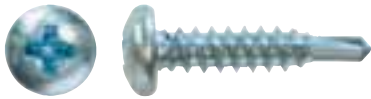

Self-Drilling Screws, Pan Head - PHILLIPS

Zinc plated steel. DIN 7504N.

Part No.	Pack of	Gauge x Length	Size x Length
HPD6/4	200	6 x 1/2"	3.5 x 13 mm
HPD6/6	200	6 x 3/4"	3.5 x 19 mm
HPD6/8	200	6 x 1"	3.5 x 25 mm
HPD8/4	200	8 x 1/2"	4.2 x 13 mm
HPD8/6	200	8 x 3/4"	4.2 x 19 mm
HPD8/8	200	8 x 1"	4.2 x 25 mm
HPD10/4	200	10 x 1/2"	4.8 x 13 mm
HPD10/6	200	10 x 3/4"	4.8 x 19 mm
HPD10/8	200	10 x 1"	4.8 x 25 mm
HPD10/12	200	10 x 1 1/2"	4.8 x 38 mm
HPD10/16	200	10 x 2"	4.8 x 51 mm

Assorted Box of Self-Drilling Screws Pan Head - Phillips

Zinc plated steel. DIN 7504N.

Part No.	Box of
AB137	500 Pieces
3 x No. 6: x 1/2", 3/4", 1", 3 x No. 8: x 1/2", 3/4", 1".	
5 x No. 10: x 1/2", 3/4", 1", 1 1/2", x 2".	



Sheet Metal Screws, Washer Faced

Zinc plated steel. DIN 6928.

Part No.	Pack of	Gauge x Length	Size x Length
AS1	100	8 x 3/4"	4.2 x 19 mm
AS2	100	10 x 3/4"	4.8 x 19 mm
AS3	100	12 x 3/4"	5.5 x 19 mm



Sheet Metal Screws with Captive Washer

Zinc plated steel. DIN 7976.

Part No.	Pack of	Gauge x Length	Size x Length
AS12	100	8 x 1/2"	4.2 x 13 mm
AS22	100	10 x 1/2"	4.8 x 13 mm
AS32	100	12 x 1/2"	5.5 x 13 mm
AS42	100	14 x 1/2"	6.3 x 13 mm



Sheet Metal Screws with Captive Washer

Zinc plated steel. DIN 7976.

Part No.	Pack of	Gauge x Length	Size x Length
AS13	100	8 x 3/4"	4.2 x 19 mm
AS23	100	10 x 3/4"	4.8 x 19 mm
AS33	100	12 x 3/4"	5.5 x 19 mm
AS4	100	14 x 3/4"	6.3 x 19 mm

Assorted Box of Sheet Metal Screws with Captive Washer

Zinc plated steel. DIN 7976 (Screws).

Part No.	Box of
AB132	300 Pieces
2 x 8 (4.2 mm): x 1/2" (13 mm), 3/4" (19 mm).	
2 x 10 (4.8 mm): x 1/2" (13 mm), 3/4" (19 mm).	
2 x 12 (5.5 mm): x 1/2" (13 mm), 3/4" (19 mm).	
2 x 14 (6.3 mm): x 1/2" (13 mm), 3/4" (19 mm).	





Size Ø 4.8



Black Pan Head PH Screws
Gauge x L: 12 x 3/4" Head Ø: 16 mm

Part No. Pack of
FIX726 20

Honda 90114SE0000



Size Ø 4.2



Black Flanged PH Head Screws
Thread Ø x L: 4.2 x 13 mm Head Ø: 12 mm

Part No. Pack of
FIX728 20

Universal



Size Ø 4.8



Black Bumper Cover PH Screws
Thread Ø x L: 4.8 x 14 mm Washer Ø: 16 mm

Part No. Pack of
FIX734 20

Honda 90126SR4000

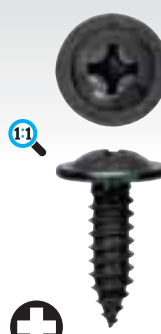

Size Ø 6.3



Black Flanged PH Head Screws
Gauge x L: 14 x 3/4" Head Ø: 15 mm

Part No. Pack of
FIX719 20

Hyundai 9215522000

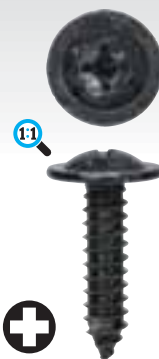

Size Ø 6.3



Black Flanged Head PH Screws
Gauge x L: 14 x 1" Head Ø: 16 mm

Part No. Pack of
FIX720 20

Hyundai / VW



Hole Ø M6



Black Bolts For Bumper
Head Ø x H: 18 x 24

Part No. Pack of
FIX725 10

Fiat 46419734



Size Ø M6



Dacromat Finish TX Bolt Screws
Thread: M6 x 15 mm Head Ø: 14 mm

Part No. Pack of
FIX733 20

Merc N000000001476



Size Ø 4.2



Black TX Body Screws with Captive Washers
Gauge x L: 8 x 5/8" Washer Ø: 14 mm

Part No. Pack of
FIX161 50

FIX161



Size Ø 4.8



Black TX20 Washer Faced Body Screws
Thread Ø x L: 4.8 x 17 mm Head Ø: 15 mm

Part No. Pack of
FIX162 50

FIX162



Size Ø 5.2



Black TX Body Screws
Thread Ø x L: 5.2 x 16 mm Head Ø: 15 mm

Part No. Pack of
FIX714 20

VW N90775001 / N90648702



Size Ø 6.0



Black TX Body Screws
Thread Ø x L: 6.0 x 23 mm Head Ø: 15 mm

Part No. Pack of
FIX715 20

PSA

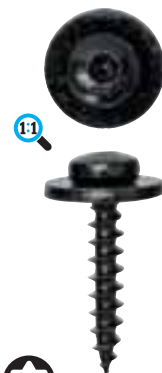

Size Ø 4.8



Black TX Screws
Thread Ø x L: 4.8 x 23 mm Washer Ø: 16 mm

Part No. Pack of
FIX729 20

Renault 7701049008 / 7703017090



Size Ø M6



Black TX Bumper Bolts
Thread: M6 x 20 mm Head Ø: 19 mm

Part No. Pack of
FIX716 20

PSA 742723
VW 6N0807199 / N907750 01





Size Ø **M6**

Zinc Plated Hex Bolt Screws with Captive Washer
Thread: M6 x 18 mm Washer Ø: 20 mm

Part No.	Pack of
FIX150	50



Size Ø **M6**

Zinc Plated Hex Bolt Screws with Captive Washer
Thread: M6 x 18 mm Washer Ø: 18 mm

Part No.	Pack of
FIX151	50



Size Ø **M6**

Zinc Plated Hex Bolt Screws with Captive Washer
Thread: M6 x 10 mm Washer Ø: 18 mm

Part No.	Pack of
FIX152	50



Size Ø **M6**

Zinc Plated Hex Bolt Screws with Captive Washer
Thread: M6 x 12 mm Washer Ø: 18 mm

Part No.	Pack of
FIX732	20

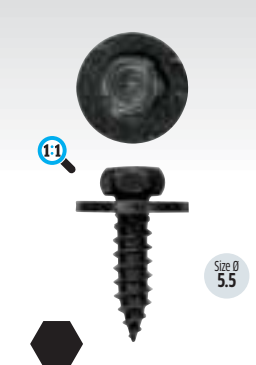

Size Ø **5.5**

Black Hex Screws with Captive Washer
Thread Ø x L: 5.5 x 17 mm Washer Ø: 15 mm

Part No.	Pack of
FIX721	20

BMW 7119904288



Size Ø **4.8**

Black Sheet Metal Screws, Washer Faced
Gauge x L: 10 x 3/4" Washer Ø: 15 mm

Part No.	Pack of
FIX155	50



Size Ø **6.3**

Black Sheet Metal Screws with Captive Washer
Gauge x L: 14 x 3/4" Washer Ø: 18 mm

Part No.	Pack of
FIX153	50



Size Ø **5.6**

Black 20 mm Hex Screws
Thread Ø x L: 5.6 x 22 mm Washer Ø: 20 mm

Part No.	Pack of
FIX730	20

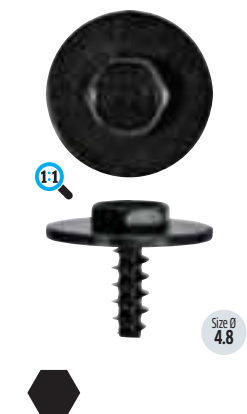

Size Ø **4.8**

Black Sheet Metal Screws with Captive Washer
Thread Ø x L: 4.8 x 13 mm Washer Ø: 22 mm

Part No.	Pack of
FIX149	50



Size Ø **4.8**

Black Hex Screws
Thread Ø x L: 4.8 x 17 mm Washer Ø: 26 mm

Part No.	Pack of
FIX724	20

Merc 2019900536



Size Ø **M5**

Black Hex Bolt Screws with Washer
Thread: M5 x 15 mm Washer Ø: 12.5 mm

Part No.	Pack of
FIX737	20



Size Ø **M6**

Black Hex Bolt Screws with Washer
Thread: M6 x 21 mm Washer Ø: 16.8 mm

Part No.	Pack of
FIX735	20



Size Ø **M6**

Black Hex Bolt Screws with Washer
Thread: M6 x 22 mm Washer Ø: 24 mm

Part No.	Pack of
FIX736	20



Size Ø **M8**

Black Hex Bolt Screws with Washer
Thread: M8 x 27 mm Washer Ø: 24 mm

Part No.	Pack of
FIX731	20



Size Ø **M8**

Black Serrated Head Bolts
Thread: M8 x 14 Head Ø: 16.5

Part No.	Pack of
FIX738	20



U-Nuts

Zinc plated steel. BS EN 10132 : 2000



Screw Ø: No. 4 (2.9 mm)
W x L x R: 8 x 11 x 5 mm

Part No.	Pack of
HUC7	100



Screw Ø: No. 6 (3.5 mm)
W x L x R: 8 x 12 x 6.5 mm

Part No.	Pack of
HUC11	100



BEST SELLER

Screw Ø: No. 6 (3.5 mm)
W x L x R: 11 x 16.5 x 7 mm

Part No.	Pack of
HUC1	100



Screw Ø: No. 8 (4.2 mm)
W x L x R: 11 x 16.5 x 7 mm

Part No.	Pack of
HUC21	100



BEST SELLER

Screw Ø: No. 8 (4.2 mm)
W x L x R: 12.5 x 14 x 7.5 mm

Part No.	Pack of
HUC2	100

BEST SELLER



Screw Ø: No. 8 (4.2 mm)
W x L x R: 11 x 16.5 x 7 mm

Part No.	Pack of
HUC22	100



Phosphate Silver
Screw Ø: No. 8 (4.2 mm)
W x L x R: 16.5 x 11 x 8 mm

Part No.	Pack of
FIX154	50

GM 90270271



Zinc plated steel.
Screw Ø: No. 8 (4.2 mm)
W x L x R: 16 x 11 x 8 mm

Part No.	Pack of
FIX653	20

Merc 0009947345



Screw Ø: No. 8 (4.2 mm)
W x L x R: 11 x 24.5 x 14 mm

Part No.	Pack of
HUC6	100



Zinc plated steel.
Screw Ø: No. 8 (4.2 mm)
W x L x R: 11 x 25 x 16 mm

Part No.	Pack of
FIX652	20

Merc 1239940645

BEST SELLER



Screw Ø: No. 10 (4.8 mm)
W x L x R: 12.5 x 20 x 10 mm

Part No.	Pack of
HUC3	100

BEST SELLER



Screw Ø: No. 12 (5.5 mm)
W x L x R: 15 x 30 x 11.5 mm

Part No.	Pack of
HUC4	100

BEST SELLER



Screw Ø: No. 14 (6.3 mm)
W x L x R: 14 x 21 x 11 mm

Part No.	Pack of
HUC5	100



1:1 Actual Size Images

J-Nuts

Zinc plated steel.



Screw Ø: No. 8 (4.2 mm)
W x L x R: 11.5 x 16.5 x 9 mm

Part No.	Pack of
HJC1	100



Screw Ø: No. 10 (4.8 mm)
W x L x R: 13 x 20 x 10 mm

Part No.	Pack of
HJC2	100



Screw Ø: No. 12 (5.5 mm)
W x L x R: 15 x 25 x 12 mm

Part No.	Pack of
HJC3	100



Screw Ø: No. 14 (6.3 mm)
W x L x R: 14.5 x 25 x 13 mm

Part No.	Pack of
HJC4	100

Assorted Box of U-Nuts & J-Nuts

Zinc plated steel.

Part No.	Box of
AB49N	250 Pieces

5 x U-Nuts: No. 6, 8, 10, 12, 14.
4 x J-Nuts: No. 8, 10, 12, 14.



Assorted Box of U-Nuts

Zinc plated steel.

Part No.	Box of
AB166	200 Pieces

10 x Sizes: No. 4, 6 (x 2), 8 (x 4), 10, 12, 14.



Chimney Nuts



11 Thread Ø: M6
W x L x R: 16 x 24 x 12 mm

Part No.	Pack of
HUC59	10



11 Thread Ø: M6
W x L x R: 14 x 24 x 15 mm

Part No.	Pack of
HUC55	25



11 Thread Ø: M6
W x L x R: 16 x 24 x 12 mm

Part No.	Pack of
FIX722	20

VW



11 Thread Ø: M5
W x L x R: 15 x 21 x 11 mm

Part No.	Pack of
HUC56	10

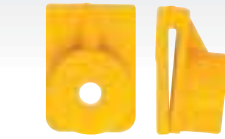

11 Hole Ø: 3
W x L x R: 17 x 12 x 9.5 mm

Part No.	Pack of
FIX409	20

Fiat 1488680



11 Thread Ø: M5
W x L x R: 15.5 x 12 x 6 mm

Part No.	Pack of
FIX661	20

Merc A0039944245



11 Thread Ø: M6
W x L x R: 21 x 16 x 9 mm

Part No.	Pack of
FIX660	10

Merc A0049941545



11 Thread Ø: M6
W x L x R: 16 x 18.5 x 9 mm

Part No.	Pack of
HUC52	25

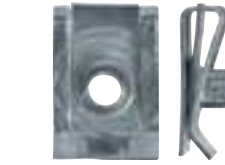

11 Thread Ø: M5
W x L x R: 15 x 21 x 10 mm

Part No.	Pack of
HUC50	25



11 Hole Ø: 4
W x L x R: 18.5 x 28 x 10 mm

Part No.	Pack of
FIX453	20

BMW 0714721877 / 51417025609



11 Thread Ø: M6
W x L x R: 16 x 24 x 12 mm

Part No.	Pack of
HUC57	10

**BEST
SELLER**



11 Thread Ø: M6
W x L x R: 16 x 23.5 x 12 mm

Part No.	Pack of
HUC51	25

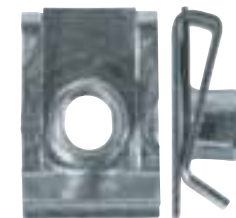

11 Thread Ø: M8
W x L x R: 18.5 x 28 x 14 mm

Part No.	Pack of
HUC58	10

**MAX
BOX**

'Max Box' Assortment of Sheet Metal Screws, U-Nuts & J-Nuts

Zinc plated steel.
DIN 7976 (Screws), BS EN 10132 : 2000 (U-Nuts).

Part No.	Box of
AB504	600 Pieces

3 x Washer Faced Screws: 8 x 3/4" (4.2 x 19 mm), 10 x 3/4" (4.8 x 19 mm), 12 x 3/4" (5.5 x 19 mm),
8 x Captive Washer Screws: 8 x 1/2" (4.2 x 13 mm), 8 x 3/4" (4.2 x 19 mm), 10 x 1/2" (4.8 x 13 mm), 10 x 3/4" (4.8 x 19 mm),
12 x 1/2" (5.5 x 13 mm), 12 x 3/4" (5.5 x 19 mm), 14 x 1/2" (6.3 x 13 mm), 14 x 3/4" (6.3 x 19 mm),
6 x U-Nuts: No. 8 (4.2 mm) (3 x Sizes), No. 10 (4.8 mm), No. 12 (5.5 mm), No. 14 (6.3 mm). 1 x J-Nuts: No. 14 (6.3 mm).



Assorted Box of Chimney Nuts Zinc & Black.

Part No.	Box of
AB167N	60 Pieces

1 x Zinc M5. 2 x Zinc M6. 1 x Black M6.



Assorted Box of Sheet Metal Screws & J-Nuts

Zinc plated steel. BS 4174 (Screws).

Part No.	Box of
AB51N	350 Pieces

3 x Washer-Faced Screws: No. 8, 10, 12.
1 x Screws with Captive Washers: No. 14.
4 x J-Nuts: No. 8, 10, 12, 14.



Spring Nuts



Zinc/Alu Finish
Part No. **FIX195** **Pack of** 10
 VW 8D0805121



Zinc/Alu Finish Spring Nuts
 W x L x R: 25 x 24 x 11 mm
Part No. **FIX200** **Pack of** 10
 VW 8D0805960



Zinc/Alu Finish Spring Nuts
 W x L x R: 19 x 23 x 12 mm
Part No. **FIX862** **Pack of** 20
 VW 8K0805922A



Zinc/Alu Finish
 Heat Shield Clip/Nut Washers
Part No. **FIX183** **Pack of** 50
 VW N90796501 Ford 6715468



Zinc/Alu Finish
Part No. **FIX184** **Pack of** 50
 VW 8D0805121 / N90335004 /
 N90335006
 Ford V703505301 PSA 6715468



Black
Part No. **FIX196** **Pack of** 10



Black Quarter Turn Studs
 Ø x H 18 x 23 mm
Part No. **FIX194** **Pack of** 10



Black Trim Clips
 W x D x H 15.5 x 9 x 25 mm
Part No. **FIX630** **Pack of** 20
 VW 1J6867276



Black Headlight
 Adjuster Clips
 W x D x H 20 x 16 x 15 mm
Part No. **FIX202** **Pack of** 20
 VW 4A0805163



Flat Clips (Push-on Fixes) - Round
 Zinc plated steel.

Part No.	Pack of	I.D.	
HFC1	200	(2.4 mm)	3/32"
HFC2	200	(3.2 mm)	1/8"
HFC9	200	5.0 mm	(3/16")
HFC10	200	6.0 mm	(1/4")
HFC11	200	8.0 mm	(5/16")
HFC12	200	(10.0 mm)	3/8"



Flat Clips (Push-on Fixes) - Rectangular
 Zinc plated steel.

Part No.	Pack of	I.D.	
HFC6	200	(2.4 mm)	3/32"
HFC7	200	(3.2 mm)	1/8"
HFC8	200	(4.0 mm)	5/32"

Assorted Box of Flat Clips (Push-on Fixes)
 Zinc plated steel.

Part No.	Box of
AB50	1,000 Pieces

3 x Round, Imperial: 3/32", 1/8", 3/8".
 3 x Round, Metric (Imperial):
 5 mm (3/16"), 6 mm (1/4"), 8 mm (5/16").
 3 x Rectangular: 3/32", 1/8", 5/32".



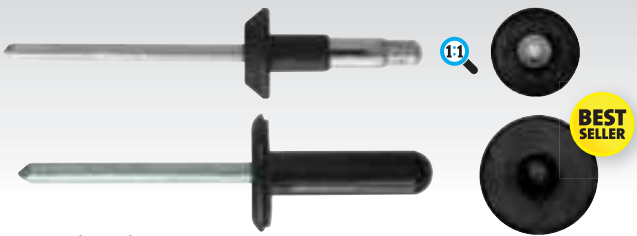

Body Trim Rivets
Aluminium/Black Plastic Flange

Part No.	Pack of	Head Ø	Flange Ø	OEM Ref
FIX206	50	4 mm	11.8 mm	Volvo 979878
FIX207	50	6 mm	15.8 mm	Ford 1041415 / W7044395 / W709095533

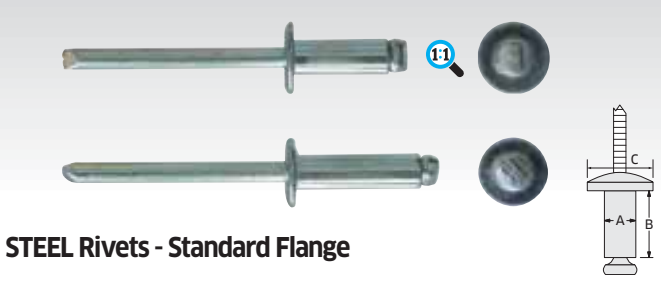

STEEL Rivets - Standard Flange

Part No.	Pack of	Ø (A) x Length (B)	Flange Ø (C)
PRS4	100	4.8 x 12 mm (3/16" x 15/32")	9.5 mm
PRS5	100	4.8 x 16 mm (3/16" x 5/8")	9.2 mm



Trim Clip Rivets
Aluminium

Part No.	Pack of	Ø	OEM Ref
FIX70	50	2.4 mm	Ford 6028434 GM 164361 / 90033713



POP AVDEL 'Bulbex' Rivets - Standard Flange
Aluminium.

Part No.	Pack of	Ø (A) x Length (B)	Flange Ø (C)
PR10	200	4.8 x 23 mm (3/16" x 7/8")	9.5 mm
PR12	200	4.8 x 27 mm (3/16" x 11/16")	9.7 mm

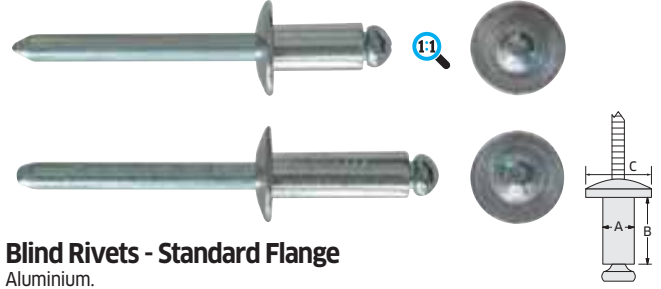

Blind Rivets - Standard Flange
Aluminium.

Part No.	Pack of	Ø (A) x Length (B)	Flange Ø (C)
PR112	100	6.4 x 12 mm (1/4" x 1/2")	12.6 mm
PR114	250	6.4 x 18 mm (1/4" x 3/4")	12.5 mm



POP AVDEL Blind Rivets - Standard Flange
Aluminium.

Part No.	Pack of	Ø (A) x Length (B)	Flange Ø (C)
PR214	100	6.4 x 19.5 mm (1/4" x 3/4")	12.6 mm



Rivet Washers
Zinc plated steel.

Part No.	Pack of	Size
PRW1	1,000	M3 x 13 (1/8" x 1/2")

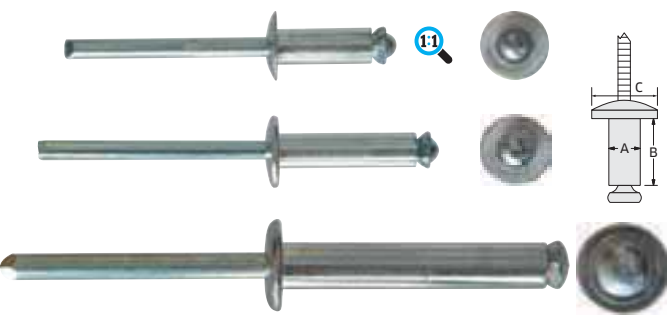

Rivets - Peel Back Type
Aluminium.

Part No.	Pack of	Ø (A) x Length (B)	Flange Ø (C)
PR47	100	4.8 x 12 mm (3/16" x 15/32")	9.2 mm
PR48	100	4.8 x 18 mm (3/16" x 23/32")	9.5 mm
PR49	100	6.4 x 35 mm (1/4" x 1 3/8")	12.3 mm
PRL49	1,000	6.4 x 35 mm (1/4" x 1 3/8")	12.3 mm



Speed Fasteners - Cage Nuts
Zinc plated steel.

Part No.	Pack of	Screw Size	Hole Ø	Panel Thickness
HCN61	100	M6 Narrow	9.5 mm	0.71 - 1.63 mm
HCN62	100	M6 Wide	9.5 mm	1.83 - 2.64 mm





Black Rivets - Standard Flange

Black anodised aluminium.

Part No.	Pack of	Ø (A) x Length (B)	Flange Ø (C)
PRB11	100	3.2 x 8 mm (1/8" x 5/16")	5.7 mm
PRB12	100	4.0 x 10 mm (5/32" x 3/8")	7.7 mm
PRB13	100	4.8 x 14 mm (3/16" x 1/2")	9.3 mm

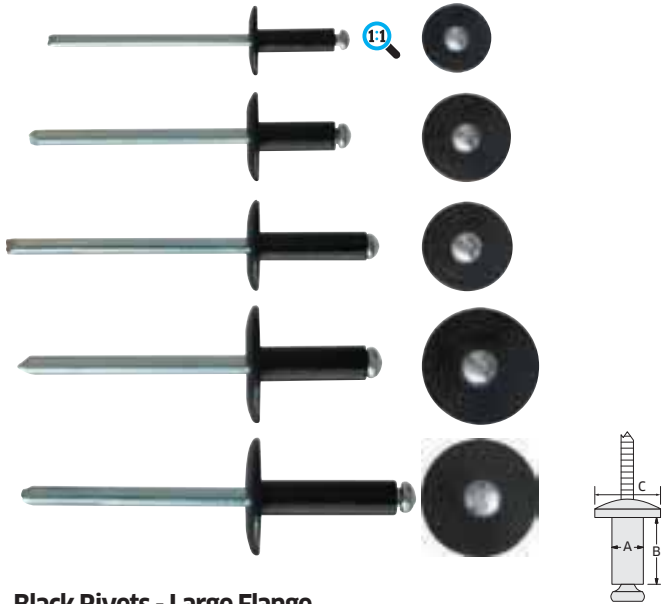

Black Rivets - Large Flange

Black anodised aluminium.

Part No.	Pack of	Ø (A) x Length (B)	Flange Ø (C)
PRB21	100	3.2 x 10 mm (1/8" x 3/8")	9.2 mm
PRB22	100	4.0 x 10 mm (5/32" x 3/8")	11.8 mm
PRB25	100	4.0 x 14 mm (5/32" x 1/2")	11.8 mm
PRB23	100	4.8 x 14 mm (3/16" x 1/2")	15.4 mm
PRB24	100	4.8 x 18 mm (3/16" x 3/4")	15.4 mm

Assorted Box of Black Rivets

Black anodised aluminium.

Part No.	Box of
AB112	200 Pieces

1 x Standard Flange, 3.2 x 8 mm.
 1 x Standard Flange, 4.0 x 10.
 1 x Standard Flange, 4.8 x 14 mm.
 1 x Large Flange, 3.2 x 10 mm.
 2 x Large Flange, 4.0: x 10, 14 mm.
 2 x Large Flange, 4.8: x 14, 18 mm.

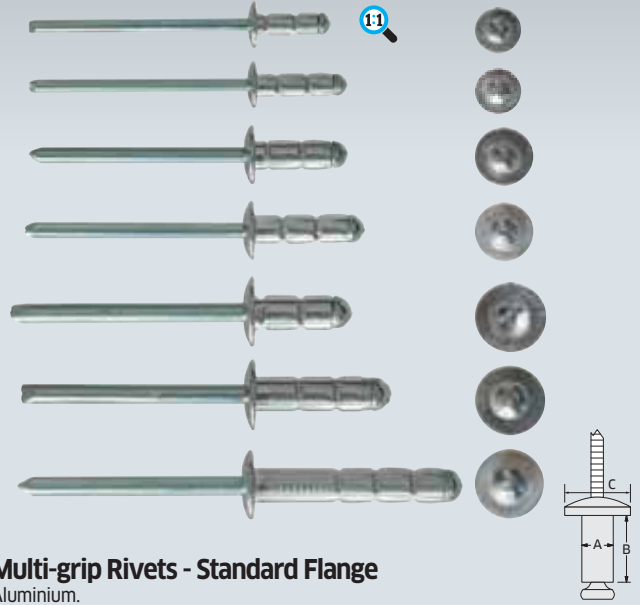

Multi-grip Rivets - Standard Flange

Aluminium.

Part No.	Pack of	Ø (A) x Length (B)	Flange Ø (C)
PR101	500	3.2 x 8 mm (1/8" x 5/16")	6.1 mm
PR102	500	3.2 x 10 mm (1/8" x 3/8")	6.1 mm
PR103	500	4.0 x 10 mm (5/32" x 3/8")	7.7 mm
PR104	500	4.0 x 14 mm (5/32" x 9/16")	7.7 mm
PR105	500	4.8 x 13 mm (3/16" x 1/2")	9.3 mm
PR106	500	4.8 x 15 mm (3/16" x 19/32")	9.3 mm
PR109	200	4.8 x 25 mm (3/16" x 31/32")	9.1 mm



Multi-grip Rivets - Large Flange

Aluminium.

Part No.	Pack of	Ø (A) x Length (B)	Flange Ø (C)
PR111	200	4.8 x 10 mm (3/16" x 3/8")	15.5 mm
PR107	200	4.8 x 18 mm (3/16" x 23/32")	15.3 mm
PR108	200	4.8 x 25 mm (3/16" x 31/32")	15.3 mm



Actual Size Images

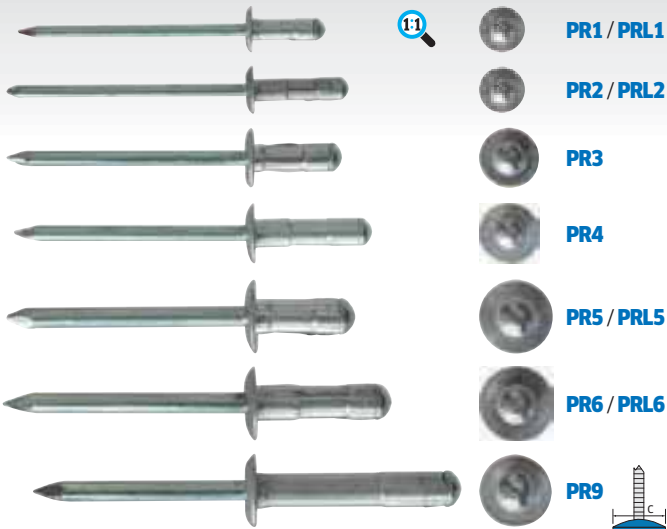

POP AVDEL 'Avex' Multi-grip Rivets - Standard Flange
Aluminium.

Part No.	Pack of	Ø (A) x Length (B)	Flange Ø (C)
PR1	500	3.2 x 10 mm (1/8" x 3/8")	6.2 mm
PRL1	10,000	3.2 x 10 mm (1/8" x 3/8")	6.2 mm
PR2	500	3.2 x 13 mm (1/8" x 1/2")	6.3 mm
PRL2	8,000	3.2 x 13 mm (1/8" x 1/2")	6.3 mm
PR3	500	4.0 x 12 mm (5/32" x 7/16")	7.7 mm
PR4	500	4.0 x 15 mm (5/32" x 9/16")	7.9 mm
PR5	500	4.8 x 13 mm (3/16" x 1/2")	9.7 mm
PRL5	4,000	4.8 x 13 mm (3/16" x 1/2")	9.7 mm
PR6	500	4.8 x 19 mm (3/16" x 3/4")	9.8 mm
PRL6	4,000	4.8 x 19 mm (3/16" x 3/4")	9.8 mm
PR9	200	4.8 x 27 mm (3/16" x 1")	9.3 mm

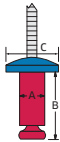

POP AVDEL 'Avex' Multi-grip Rivets - Large Flange
Aluminium.

Part No.	Pack of	Ø (A) x Length (B)	Flange Ø (C)
PR11	200	4.8 x 13 mm (3/16" x 1/2")	15.6 mm
PR7	200	4.8 x 19 mm (3/16" x 3/4")	15.5 mm
PRL7	2,000	4.8 x 19 mm (3/16" x 3/4")	15.5 mm
PR8	200	4.8 x 27 mm (3/16" x 1")	15.5 mm
PRL8	2,000	4.8 x 27 mm (3/16" x 1")	15.5 mm

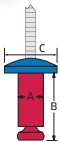

Assorted Box of POP AVDEL 'Avex' Multi-grip Rivets with Washers
Aluminium.

Part No.	Box of
AB48N	440 Pieces
2 x Standard Flange, 3.2: x 10, 13 mm. 2 x Standard Flange, 4.0: x 12, 15 mm. 2 x Standard Flange, 4.8: x 13, 19 mm. 1 x Large Flange, 4.8: x 19 mm. 1 x Washers, M3 x 13.	



Rivets - Sealed Type (Closed End)
Aluminium. DIN 7337.

Part No.	Pack of	Ø (A) x Length (B)	Flange Ø (C)
PRC50	100	4.8 x 10 mm (3/16" x 3/8")	9.3 mm
PRC53	100	4.8 x 12 mm (3/16" x 7/16")	9.3 mm
PRC54	100	4.8 x 14 mm (3/16" x 9/16")	9.3 mm
PRC56	100	4.8 x 16 mm (3/16" x 5/8")	9.7 mm
PRC58	100	4.8 x 18 mm (3/16" x 3/4")	9.3 mm

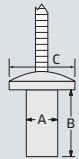

Assorted Box of Rivets - Sealed Type (Closed End)
Aluminium. DIN 7337.

Part No.	Box of
AB146N	200 Pieces
5 x Sizes: 4.8 x 10, 12, 14, 16, 18 mm.	

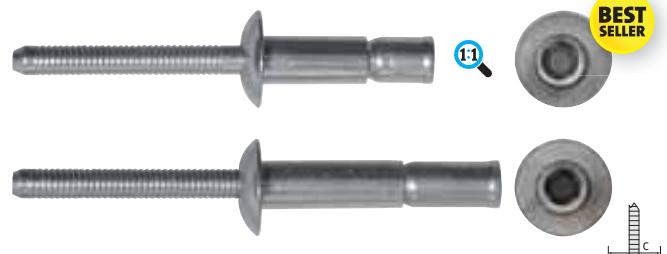

Monobolts - 2771 Series
Protruding head. Zinc plated carbon steel.

Part No.	Pack of	Ø (A) x Length (B)	Flange Ø (C)
HMB623	100	6.4 x 23 mm (1/4" x 7/8")	12.9 mm
HMB632	100	6.4 x 32 mm (1/4" x 1 1/4")	12.9 mm

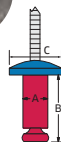



ECLIPSE-SPIRALUX Lazy Tong Riveter

Complete with nose spanner and 3 interchangeable noses for 3, 4 and 5 mm rivets. Suitable for aluminium/steel rivets.

Part No.	Qty	Description
TL811	1	Lazy Tong Riveter
TL817	1 Kit	Jaw Repair Kit



ECLIPSE-SPIRALUX Standard Rivet Gun

Complete with nose spanner and 3 interchangeable noses for 3, 4 and 5 mm rivets. Suitable for aluminium/steel rivets.

Part No.	Qty	Description
TL801	1	Rivet Gun
TL816	1 Kit	Jaw Repair Kit



ECLIPSE-SPIRALUX Replacement Noses For Lazy Tong Riveter and Standard Rivet Gun

Suits Part No.s: TL801 and TL811.

Part No.	Pack of	For Rivet Size
TL802	5	3 mm (1/8")
TL803	5	4 mm (5/32")
TL804	5	5 mm (3/16")

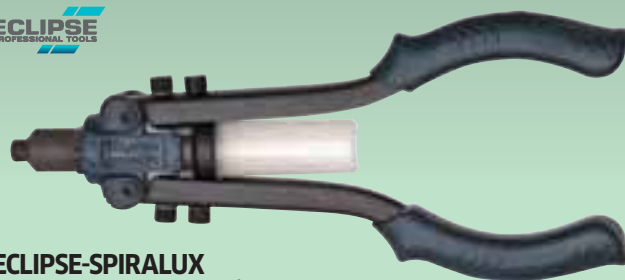

ECLIPSE-SPIRALUX Compact Lever Arm Riveter

Contains rivet noses for use with 2.4, 3.2, 4.0, 4.8 & 6.4 mm aluminium and steel rivets. Noses are colour coded by size for easy identification changeable by hand - no need for extra tools.

- Strong 3-piece alloy steel jaw mechanism with hexagonal internal structure for a longer life and easy operating
- Reinforced 2 mm thick Carbon Steel heat-treated handle for extra strength and durability
- Ergonomically designed handles for comfortable use
- Features a convenient rivet stem collector for protection and safety

Part No.	Qty	Description
TL822	1	Compact Lever Arm Riveter



ECLIPSE-SPIRALUX Compact Lever Arm Riveter - Replacement Nozzles

Suits Part No. TL822.

Part No.	Qty	Size
TL822-2	1	2.4 mm (3/32")
TL822-3	1	3.2 mm (1/8")
TL822-4	1	4.0 mm (5/32")
TL822-5	1	4.8 mm (3/16")
TL822-6	1	6.0 mm (1/4")



ECLIPSE-SPIRALUX Compact Lever Arm Riveter - Replacement Jaws

Suits Part No. TL822.

Part No.	Qty	Description
TL823	1 Kit	Replacement Jaws



ECLIPSE-SPIRALUX Rivet Gun

Complete with 4 interchangeable noses for 2.4, 3.2, 4.0 and 4.8 mm aluminium rivets. NOT suitable for steel rivets. Automatic ejection of the mandrel. Slip guarded comfort handle.

Part No.	Qty	Description
TL800	1	Rivet Gun

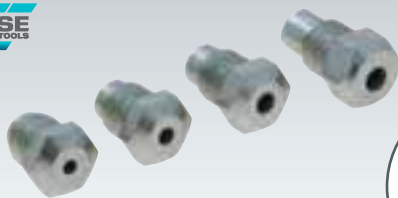

**ECLIPSE-SPIRALUX
'Classic' Long Arm Riveter - Nose Kit**

Suits classic model ONLY (Part No. TL821).

Part No.	Qty	Repairs
TL825	Set of 4	Long Arm Riveter

For Rivet Sizes: 4, 5 (x 2) and 6 mm (5/32", 3/16", 1/4").



**ECLIPSE-SPIRALUX
'Classic' Long Arm Riveter
- Replacement Jaws**

Suits classic model ONLY (Part No. TL821).

Part No.	Qty	Description
TL826	1 Kit	Replacement Jaws

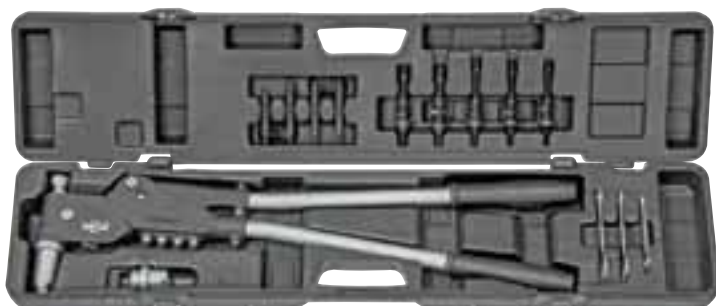

Heavy Duty Accordion Riveting Pliers

Complete with interchangeable nose piece. For 2.4, 3.2, 4.0 and 4.8 mm rivets.

Part No.	Qty	Description
TL8110	1	Heavy Duty Accordion Riveter



Swivel Head Riveter 360° Action

Contains rivet noses for use with 2.4 (3/32"), 3.2 (1/8"), 4.0 (5/32") & 4.8 mm (3/16") aluminium, steel and stainless steel rivets. Slip guarded comfort handles.

Part No.	Qty	Description
TL890	1	Swivel Head Riveter



Heavy Duty Long Handled Swivel Head Riveter and Nut Sert Riveter Kit

Combination set for standard rivets 2.4, 3.2, 4.0 and 4.8 mm and nutserts 4.0 to 10.0 mm.

Part No.	Qty	Description
TL8100	1 Kit	17 Piece Kit

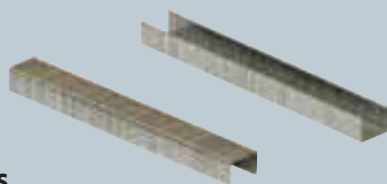

Metal Staples

Suits Part No. STAP4.

Part No.	Pack of	Size
STAP5	2,000	8 mm



Metal Staple Tacker

Takes 8 mm staples.

Part No.	Qty	Description
STAP4	1	Staple Gun





Circlips - Internal

Carbon spring steel, phosphate finish.
DIN 472.

Part No.	Pack of	Bore Size	Circlip O.D.
HCL111	100	11 mm	11.8 mm
HCL113	100	13 mm	14.1 mm
HCL116	100	16 mm	17.3 mm
HCL119	100	19 mm	20.5 mm
HCL121	100	21 mm	22.5 mm
HCL122	100	22 mm	23.5 mm
HCL125	100	25 mm	26.9 mm
HCL130	100	30 mm	32.1 mm
HCL135	100	35 mm	37.8 mm
HCL138	100	38 mm	40.8 mm
HCL140	50	40 mm	43.5 mm
HCL142	50	42 mm	45.5 mm
HCL147	50	47 mm	50.5 mm



Circlips - External

Carbon spring steel, phosphate finish.
DIN 471.

Part No.	Pack of	Shaft Size	Circlip I.D.
HCL207	500	7 mm	6.5 mm
HCL208	500	8 mm	7.4 mm
HCL210	500	10 mm	9.3 mm
HCL211	100	11 mm	10.2 mm
HCL212	500	12 mm	11.0 mm
HCL213	100	13 mm	11.9 mm
HCL214	200	14 mm	12.9 mm
HCL215	200	15 mm	13.8 mm
HCL216	100	16 mm	14.7 mm
HCL217	200	17 mm	15.7 mm
HCL218	200	18 mm	16.5 mm
HCL219	100	19 mm	17.5 mm
HCL220	200	20 mm	18.5 mm
HCL221	100	21 mm	19.5 mm
HCL222	100	22 mm	20.5 mm
HCL224	100	24 mm	22.2 mm
HCL225	100	25 mm	23.2 mm
HCL230	100	30 mm	27.9 mm
HCL235	100	35 mm	32.2 mm
HCL238	100	38 mm	35.2 mm
HCL240	50	40 mm	36.5 mm
HCL250	25	50 mm	45.8 mm

Assorted Box of Circlips Internal - Metric

DIN 472.

Part No.	Box of
AB173	230 Pieces

13 x Sizes: 11, 13, 16, 19, 21, 22, 25, 30, 35, 38, 40, 42, 47 mm.



Assorted Box of Circlips External - Metric

DIN 471.

Part No.	Box of
AB174	350 Pieces

16 x External Sizes: 7, 8, 10, 12, 14, 15, 17, 18, 20, 22, 24, 25, 30, 35, 40, 50 mm.



'Max Box' Assortment of Circlips Internal & External - Metric

DIN 472 (Internal), DIN 471 (External).

Part No.	Box of
AB561	400 Pieces

3 x Internal: 40, 42, 47 mm. 15 x External: 7, 8, 10, 12, 14, 15, 17, 18, 20, 24, 25, 30, 35, 40, 50 mm.



Assorted Box of Circlips Internal & External - Metric

DIN 472 (Internal), DIN 471 (External).

Part No.	Box of
AB37N	280 Pieces

10 x Internal Sizes: 11, 13, 16, 19, 21, 22, 25, 30, 35, 38 mm.
10 x External Sizes: 11, 13, 16, 19, 21, 22, 25, 30, 35, 38 mm.





E-Retainers - Metric

DIN 6799.

Part No.	Pack of	Size
HER1	100	1.70 mm
HER2	100	2.75 mm
HER3	100	3.50 mm
HER4	100	4.50 mm
HER6	100	6.00 mm
HER7	100	7.00 mm
HER13	100	13.00 mm
HER15	100	15.50 mm

Assorted Box of E-Retainers - Metric

DIN 6799.

Part No.	Box of
AB127N	725 Pieces

8 x Sizes (Shaft Ø): 1.7, 2.75, 3.5, 4.5, 6.0, 7.0, 13.0, 15.5 mm.



E-Retainers - Imperial

DIN 6799 (BS 3673/2).

Part No.	Pack of	Size
HER51	100	1/8"
HER52	100	5/32"
HER53	100	3/16"
HER54	100	7/32"
HER55	100	1/4"
HER56	100	5/16"
HER57	100	3/8"
HER58	100	7/16"
HER59	100	1/2"
HER60	100	5/8"

Assorted Box of E-Retainers - Imperial

DIN 6799 (BS 3673/2).

Part No.	Box of
AB55N	800 Pieces

10 x Sizes (Shaft Ø): 1/8", 5/32", 3/16", 7/32", 1/4", 5/16", 3/8", 7/16", 1/2", 5/8".



Clevis Pins

BS 1574

Part No.	Pack of Size	Grip Length
HCP5	50 6.0 x 20.0 mm (1/4" x 3/4")	20.2 mm (25/32")
HCP1	50 3/16" x 5/8"	(4.8 x 15.9 mm) 15/32" (12.2 mm)
HCP2	50 3/16" x 7/8"	(4.8 x 22.2 mm) 11/16" (18.0 mm)
HCP3	50 1/4" x 1/2"	(6.4 x 12.7 mm) 9/32" (7.4 mm)
HCP4	50 1/4" x 11/16"	(6.4 x 17.5 mm) 17/32" (13.7 mm)
HCP6	50 9/32" x 7/8"	(7.1 x 22.2 mm) 5/8" (16.5 mm)
HCP7	50 5/16" x 1"	(7.9 x 25.4 mm) 25/32" (20.2 mm)
HCP8	50 3/8" x 1 1/4"	(9.5 x 31.8 mm) 29/32" (23.6 mm)

Assorted Box of Clevis Pins

BS 1574.

Part No.	Box of
AB33	200 Pieces

8 x Sizes: 3/16" x 5/8", 3/16" x 7/8", 1/4" x 1/2", 1/4" x 1 1/16", 9/32" x 7/8", 5/16" x 1", 3/8" x 1 1/4", M6 x 20 (1/4" x 7/8").



Linch Pins with O-Ring

Safety Type.

Part No.	Pack of	Pin Size
LP1	10	1/4" x 1 3/4"
LP2	10	5/16" x 1 1/2"
LP4	10	7/16" x 1 3/4"



Linch Pins with O-Ring

Safety Type.

Part No.	Pack of	Size	Suits
LP10	10	10 mm x 70 mm	JCB
LP11	10	9 mm x 52 mm	JCB



BEST SELLER



R-Clips

Part No.	Pack of	Pin Dia x Overall Length
LP5	50	2.5 x 45 mm
LP6	25	3 x 54 mm
LP7	25	4 x 75 mm
LP8	20	5 x 107 mm
LP9	10	6 x 117 mm

Assorted Box of R-Clips

Part No.	Box of
AB88N	80 Pieces

5 x Sizes (Wire Ø x Length): 2.5 x 45, 3 x 54, 4 x 75, 5 x 107, 6 x 117 mm.



BEST SELLER



Brake Pad Pin Retainers

Part No.	Pack of	Size	Approx. Length	Wire Ø
BR6	100	Small	19 mm	1.2 mm
BR7	100	Large	23 mm	1.5 mm



Double Type R-Clip Module Assembly

R-clip dimensions (Wire Ø x L): 3.7 x 95 mm.

Part No.	Pack of	Description
HV20	10	R-Clip Module Assembly



Split Pins - Imperial

Zinc plated steel. DIN 94/BS 1574. (* Stainless Steel).

Part No.	Pack of	O.D. x Length
HSP20	500	1/32" x 3/4" * (1.0 x 19 mm) *
HSP1	500	1/16" x 1" (1.6 x 25 mm)
HSP2	500	5/64" x 1" (2.0 x 25 mm)
HSP3	500	3/32" x 1" (2.4 x 25 mm)
HSP4	500	3/32" x 1 1/2" (2.4 x 38 mm)
HSP5	500	7/64" x 1 1/2" (2.8 x 38 mm)
HSP6	500	1/8" x 1 1/2" (3.2 x 38 mm)
HSP7	500	9/64" x 1 1/2" (3.6 x 38 mm)
HSP12	250	5/32" x 1 5/8" (4.0 x 41 mm)
HSP8	250	5/32" x 2" (4.0 x 51 mm)
HSP9	250	3/16" x 2" (4.8 x 51 mm)
HSP10	100	1/4" x 3" (6.3 x 76 mm)
HSP11	100	5/16" x 3" (7.9 x 76 mm)

Assorted Box of Split Pins - Imperial (Small Sizes)

Zinc plated steel. DIN 94/BS 1574.

Part No.	Box of
AB32N	800 Pieces

8 x Sizes, O.D. x Length: 1/16" x 1" (1.6 x 25 mm), 5/64" x 1" (2.0 x 25 mm), 3/32" x 1" (2.4 x 25 mm), 3/32" x 1 1/2" (2.4 x 38 mm), 7/64" x 1 1/2" (2.8 x 38 mm), 1/8" x 1 1/2" (3.2 x 40 mm), 9/64" x 1 1/2" (3.6 x 40 mm), 5/32" x 1 5/8" (4.0 x 40 mm).



Assorted Box of Split Pins - Imperial (Large Sizes)

Zinc plated steel. DIN 94/BS 1574.

Part No.	Box of
AB73	225 Pieces

5 x Sizes, O.D. x Length: 1/8" x 1 1/2" (3.2 x 38 mm), 5/32" x 2" (4.0 x 51 mm), 3/16" x 2" (4.8 x 51 mm), 1/4" x 3" (6.3 x 76 mm), 5/16" x 3" (7.9 x 76 mm).



'Max Box' Assortment of Split Pins - Imperial

Zinc plated steel. DIN 94/BS 1574.

Part No.	Box of
AB508	850 Pieces

12 x Sizes, O.D. x Length: 1/16" x 1" (1.6 x 5 mm), 5/64" x 1" (2.0 x 25 mm), 3/32" x 1" (2.5 x 25 mm), 3/32" x 1 1/2" (2.4 x 38 mm), 7/64" x 1 1/2" (2.8 x 38 mm), 1/8" x 1 1/2" (3.2 x 38 mm), 9/64" x 1 1/2" (3.6 x 38 mm), 5/32" x 1 5/8" (4.0 x 41 mm), 5/32" x 2" (4.0 x 51 mm), 3/16" x 2" (4.8 x 51 mm), 1/4" x 3" (6.3 x 76 mm), 5/16" x 3" (7.9 x 76 mm).



Split Pins - Metric

Zinc plated steel. DIN 94 / ISO 1234 (BS 7774).

Part No.	Pack of	O.D. x Length	
HSP19	1,000	(1/32" x 3/8")	1.0 x 10 mm
HSP21	500	(5/64" x 9/16")	2.0 x 14 mm
HSP22	500	(5/64" x 3/4")	2.0 x 20 mm
HSP33	500	(3/32" x 1 3/32")	2.5 x 28 mm
HSP62	500	(1/8" x 3/4")	3.2 x 20 mm
HSP63	500	(1/8" x 1 1/4")	3.2 x 32 mm
HSP13	250	(5/32" x 1 3/8")	4.0 x 36 mm

Assorted Box of Split Pins - Imperial & Metric

Zinc plated steel. DIN 94/BS 1574 (Imperial).
DIN 94/ISO 1234 (BS 7774) (Metric).

Part No.	Box of
AB206	370 Pieces
4 x Imperial Sizes, O.D. x Length: 1/32" x 3/8" (1.0 x 10 mm), 5/64" x 1" (2.0 x 25 mm), 9/64" x 1 1/2" (3.6 x 38 mm), 3/16" x 2" (4.8 x 51 mm).	
6 x Metric Sizes, O.D. x Length: 2.0 x 14 mm (5/64" x 9/16"), 2.0 x 20 mm (5/64" x 3/4"), 2.5 x 28 mm (3/32" x 1 3/32"), 3.2 x 20 mm (1/8" x 3/4"), 3.2 x 32 mm (1/8" x 1 1/4"), 4.0 x 36 mm (5/32" x 1 3/8").	



Assorted Box of Compression Springs

Part No.	Box of
AB89	70 Pieces
10 x Sizes (Free Length x O.D.): 21.2 x 8.9 mm, 22.5 x 9.0 mm, 25 x 12.2 mm, 26.5 x 5.4 mm, 31.5 x 10.4 mm, 37 x 7.8 mm, 65.5 x 13 mm, 66 x 10.4 mm, 100 x 18.5 mm, 124 x 16.0 mm.	



Assorted Box of Expansion Springs

Part No.	Box of
AB72	70 Pieces
7 x Sizes (Free Length x O.D.): 29.5 x 6.4 mm, 31.5 x 5.0 mm, 33.3 x 6.8 mm, 56.5 x 7.8 mm, 74 x 10.3 mm, 90 x 11.4 mm, 126 x 9.4 mm.	



Spring Roll Pins - Metric

DIN 1481.

Part No.	Pack of	Diameter x Length
FIX18	50	8 x 55 mm
Suits FORD (Door Hinge Pin).		

Assorted Box of Spring Roll Pins - Metric

Black. DIN 1481.

Part No.	Box of
AB80	300 Pieces
12 x Sizes, O.D. x Length: 2.5 x 24 mm, 2.5 x 36 mm, 3 x 24 mm, 3 x 40 mm, 4 x 24 mm, 4 x 40 mm, 5 x 24 mm, 5 x 40 mm, 6 x 24 mm, 6 x 40 mm, 8 x 24 mm, 8 x 55 mm.	



'Max Box' Assortment of Spring Roll Pins - Metric

Black. DIN 1481.

Part No.	Box of
AB555	340 Pieces
19 x Sizes, O.D. x Length: 3 x 20 mm, 3 x 24 mm, 3 x 30 mm, 4 x 24 mm, 4 x 28 mm, 4 x 40 mm, 4 x 50 mm, 5 x 16 mm, 5 x 20 mm, 5 x 24 mm, 5 x 28 mm, 5 x 32 mm, 5 x 35 mm, 5 x 40 mm, 5 x 45 mm, 6 x 30 mm, 6 x 45 mm, 8 x 32 mm, 8 x 45 mm.	

Assorted Box of Spring Roll Pins - Imperial

Black.

Part No.	Box of
AB35	300 Pieces
11 x Sizes, O.D. x Length: 3/32" x 1", 1/8" x 1", 1/8" x 1 1/2", 5/32" x 1", 5/32" x 1 1/2", 3/16" x 1", 3/16" x 1 1/2", 1/4" x 1", 1/4" x 1 1/2", 5/16" x 1", 5/16" x 2".	



Assorted Box of Accelerator & Clutch Springs

Part No.	Box of
AB29	40 Pieces
8 x Sizes (Free Length x O.D.): 53 x 12.4 mm, 61.2 x 15.4 mm, 63.4 x 13 mm, 66 x 13.1 mm, 77.4 x 23.15 mm, 82.5 x 12.95 mm, 84.2 x 10.9 mm, 86 x 13.3 mm.	





BEST SELLER

Assorted Pack of Angle Iron

Mild steel.

Part No.	Pack of	Length
AP35	5 Pieces	1.5 m (5 ft)

3 x Sizes: (2 x) 20 x 20 x 3 mm, 30 x 30 x 3 mm, (1 x) 40 x 40 x 3 mm.

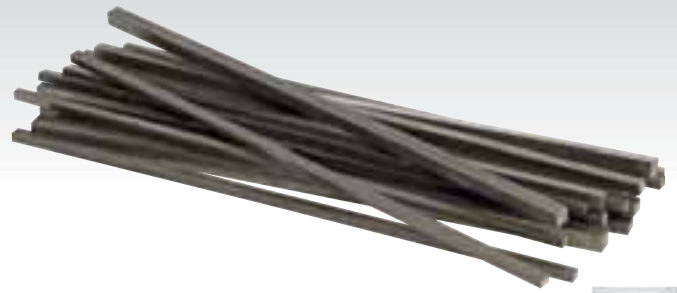

Assorted Pack of Key Steel - Imperial

Part No.	Pack of	Length
AP24	20 Pieces	12" (300 mm)

3/16" x 3/16", 1/4" x 3/16", 1/4" x 1/4", 5/16" x 1/4", 5/16" x 5/16", 3/8" x 1/4", 3/8" x 3/8", 1/2" x 5/16".



BEST SELLER

Assorted Pack of Flat Bar

Mild steel.

Part No.	Pack of	Length
AP13	9 Pieces	1.5 m (5 ft)

8 x Sizes: (2 x) 20 x 3 mm, (1 x) 20 x 5 mm, 25 x 3 mm, 25 x 5 mm, 25 x 6 mm, 40 x 3 mm, 40 x 5 mm, 40 x 6 mm.



Assorted Pack of Key Steel - Metric

Part No.	Pack of	Length
AP26	20 Pieces	12" (300 mm)

9 x Sizes: 4 x 4 mm, 5 x 5 mm, 6 x 6 mm, 8 x 7 mm, 8 x 8 mm, 10 x 8 mm, 10 x 10 mm, 12 x 8 mm, 12 x 12 mm.



Assorted Pack of Round Bar

Bright steel, free cutting.

Part No.	Pack of	Length
AP14	12 Pieces	1.5 m (5 ft)

6 Sizes, Diameters: (2 x) 3/16", 1/4", 5/16", 3/8", 7/16", 1/2"



Assorted Box of Woodruff Keys - Imperial

Part No.	Box of
AB47N	96 Pieces

15 x Sizes: 1/16" x 1/2", 3/32" x 1/2", 1/8" x 1/2", 1/8" x 5/8", 5/32" x 5/8", 5/32" x 3/4", 3/16" x 3/4", 3/16" x 7/8", 3/16" x 1 1/8", 7/32" x 7/8", 7/32" x 1 1/8", 1/4" x 1", 1/4" x 1 1/8", 5/16" x 1 1/4", 3/8" x 1 1/4".



Assorted Box of Woodruff Keys & Key Steel - Metric

Part No.	Box of
AB216	24 Pieces

3 x Woodruff Keys: 4 x 6.5 x 16 mm, 4 x 9 x 22 mm, 6 x 9 x 22 mm.
4 x Key Steel, Parallel: 8 x 7 x 25 mm, 8 x 7 x 32 mm, 8 x 7 x 36 mm, 12 x 8 x 50 mm.



Assorted Pack of Round Bar

Mild steel.

Part No.	Pack of	Length
AP15	10 Pieces	1.5 m (5 ft)

6 x Sizes, Diameters: 3/16", 1/4", 5/16", 3/8", 7/16", 1/2".





1:1 Hole Ø 4

Black Retaining Clips
W x D x H: 8 x 16.5 x 11 mm

Part No.	Pack of
FIX349	20
PSA 699786 / 9619769080 Renault 7701044547	



1:1 Hole Ø 6

Black Retainer Clips
W x D x H: 9.5 x 17.5 x 13 mm

Part No.	Pack of
FIX440	20
Fiat 60814822 / 82382670 Renault 7701026892	



1:1 Hole Ø 4

Grey Fir Tree Buttons
W x D x H: 11 x 5 x 10.5 mm

Part No.	Pack of
FIX613	20
VW 3B0839723	



1:1 Hole Ø 4

Black Door Seal Clips
W x D x H: 13 x 5 x 11 mm

Part No.	Pack of
FIX61	50
VW 251823717	



1:1 Hole Ø 4

Black Retaining Clips
W x D x H: 14 x 7 x 13.5 mm

Part No.	Pack of
FIX318	20
Renault 82176228	



1:1 Hole Ø 4

Yellow Retaining Clips
W x D x H: 14 x 6 x 14 mm

Part No.	Pack of
FIX300	20
Hyundai 8213222100	



1:1 Hole Ø 4

Green Strip Clips
W x D x H: 14 x 8 x 11.5 mm

Part No.	Pack of
FIX449	20
Honda 906646710030	



1:1 Hole Ø 4

White Door Weatherstrip Clips
W x D x H: 15 x 9 x 15 mm

Part No.	Pack of
FIX259	50
Honda 9065154N003 Hyundai 8213227100 Mitsubishi MU481276 Toyota 6786712150	



1:1 Hole Ø 4

Blue Weatherstrip Clips
W x D x H: 15 x 9 x 15 mm

Part No.	Pack of
FIX865	20



1:1 Hole Ø 4

Green Door Clips
W x D x H: 15 x 9.5 x 15 mm

Part No.	Pack of
FIX320	20
Honda 72311555003 Toyota 6786712150	



1:1 Hole Ø 4

White Weatherstrip Clips
W x D x H: 16 x 7 x 13 mm

Part No.	Pack of
FIX463	20
Honda 90664671003	



1:1 Hole Ø 4

Black Door Seal Clips
W x D x H: 17 x 5.5 x 5 mm

Part No.	Pack of
FIX79	50
VW 1H0823717	

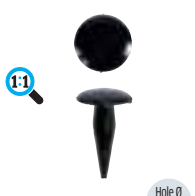

1:1 Hole Ø 3

Black Self Pierce Trim Buttons
Ø x H: 8 x 12 mm

Part No.	Pack of
FIX34	50

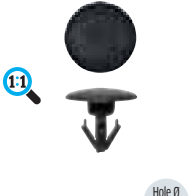

1:1 Hole Ø 4

Black Retaining Clips
Ø x H: 9.5 x 8 mm

Part No.	Pack of
FIX303	20
Mazda BP4K58762	



1:1 Hole Ø 4

Natural Door Clips
Ø x H: 12 x 17 mm

Part No.	Pack of
FIX499	20
Merc A0009871015	



1:1 Hole Ø 6

Black Trim Buttons
Ø x H: 14 x 11 mm

Part No.	Pack of
FIX380	20
Fiat 7677865	



1:1 Hole Ø 4

Black Boot Lining Clips
Ø x H: 14 x 12 mm

Part No.	Pack of
FIX302	20
Ford F1CZ16674A Mazda B455-56-741	



1:1 Hole Ø 8

Black Trim Buttons
Ø x H: 14 x 17 mm

Part No.	Pack of
FIX1	50
Mazda 155300291	



1:1 Hole Ø 6

Black Trim Buttons Self Pierce
Ø x H: 12.5 x 20 mm

Part No.	Pack of
FIX33	50
Universal	



1:1 Hole Ø 6

Black Retaining Clips
Ø x H: 14 x 17 mm

Part No.	Pack of
FIX460	20
Honda 91501-SM4-003	



1:1 Hole Ø 8

Black Trim Buttons
Ø x H: 14 x 19 mm

Part No.	Pack of
FIX46	50
VW 80186729901C / 801867299041	



1:1 Hole Ø 6

Black Multi-step Trim Buttons
Ø x H: 17 x 15 mm

Part No.	Pack of
FIX30	50
VW 82386320301C	



1:1 Hole Ø 8

Grey Trim Buttons
Ø x H: 18 x 17 mm

Part No.	Pack of
FIX36	50
Ford 1018433 / 1018434 Volvo 3272075327462A	



1:1 Hole Ø 8

Black Trim Buttons
Ø x H: 18 x 17 mm

Part No.	Pack of
FIX35	50
Ford 1629279 / 6725950 Volvo 3272075327462B	

BEST SELLER



Hole Ø 8

Gloss Black Retaining Clips
Ø x H: 18 x 18 mm

Part No.	Pack of
FIX314	20
Nissan 155300051	



Hole Ø 7

Black Bumper Shield Clips
Ø x H: 19 x 18 mm

Part No.	Pack of
FIX262	50
Chrysler 1595864 / 1605396 / 6030441	



Hole Ø 4

Black Boot Lining Clips
Ø x H: 20 x 17 mm

Part No.	Pack of
FIX261	50
Honda 90667SA70030 Nissan 8942798070	



Hole Ø 10

Black Self Pierce Trim Buttons
Ø x H: 19 x 26 mm

Part No.	Pack of
FIX58	50
VW 811863905A / 811863905A	



Hole Ø 7

Grey Seat Trim Buttons
Ø x H: 20 x 27 mm

Part No.	Pack of
FIX253	50
VW GR197S16319	



Hole Ø 8.5

Black Bonnet Clips
W x D x H: 26 x 16 mm

Part No.	Pack of
FIX301	20
Hyundai 8112637010 Toyota 9046709050	



Hole Ø 7

Black Boot Lining Clips
Ø x H: 14 x 17 mm

Part No.	Pack of
FIX267	50
GM 233895 / 2338955 PSA 896457 / 896481	



Hole Ø 4.5

Light Grey Trim Clips
Ø x H: 16 x 13 mm

Part No.	Pack of
FIX672	20
Universal	



BEST SELLER

Hole Ø 6

Black Fir Tree Trim Buttons
Ø x H: 16 x 15 mm

Part No.	Pack of
FIX20	50
Universal	



BEST VALUE

Hole Ø 6

Black Fir Tree Clips
Ø x H: 18 x 17.8 mm

Part No.	Pack of
FIX500	50
Chrysler 3691590 Ford 332364 / 389358 PSA 7518C0	



BEST VALUE

Hole Ø 6

Black Fir Tree Clips
Ø x H: 18 x 19 mm

Part No.	Pack of
FIX501	50
PSA 699295 / 6999R2	



Hole Ø 5.6

Light Grey Body Upholstery Clips
Ø x H: 18 x 22 mm

Part No.	Pack of
FIX872	20
Hyundai 8532521000Q5 Toyota 9046706020B6	



BEST VALUE

Hole Ø 6

Black Fir Tree Clips
Ø x H: 18 x 23 mm

Part No.	Pack of
FIX502	50
Honda 90667SA0003 Suzuki 618747	



Hole Ø 7.5

Dark Black Trim Clips
Ø x H: 18 x 24.5 mm

Part No.	Pack of
FIX682	20
Universal	



BEST SELLER

Hole Ø 6

Black Fir Tree Clips
Ø x H: 18 x 28 mm

Part No.	Pack of
FIX29	50



BEST VALUE

Hole Ø 6

Black Trim Buttons - Fir-Tree
Ø x H: 18 x 31 mm

Part No.	Pack of
FIX503	50
BMW 52201964201 / 52201964201 Chrysler 6033082 Ford 3900185 GM 10121502 / D2M100080	



Hole Ø 7

Natural Fir Tree Clips
Ø x H: 18.5 x 31 mm

Part No.	Pack of
FIX218	50
Land Rover Universal	



Hole Ø 6

Light Grey Trim Clips
Ø x H: 18 x 25 mm

Part No.	Pack of
FIX677	20
Universal	





Hole Ø 4

Black Fir Tree Clips
Ø x H: 18.5 x 16.5 mm

Part No. Pack of
FIX687 20

Hyundai 0810268865



Hole Ø 8

Black Trim Buttons - Fir-Tree
Ø x H: 18.5 x 23.8 mm

Part No. Pack of
FIX504 50

Universal



Hole Ø 7

Light Grey Boot Lining Clips
Ø x H: 19 x 21.5 mm

Part No. Pack of
FIX703 20

VW N90201601H



Hole Ø 7

Light Grey Trim Clips
Ø x H: 20 x 26 mm

Part No. Pack of
FIX668 20

Flat Universal



Hole Ø 7

Black Trim Buttons - Fir-Tree
Ø x H: 21 x 23 mm

Part No. Pack of
FIX505 50

Flat 1301019808



Hole Ø 9

Black Gloss Stone Shield Clips
Ø x H: 21.5 x 24 mm

Part No. Pack of
FIX705 20

GM 22512276



Hole Ø 7

Black Trim Clips
Ø x H: 22 x 25.5 mm

Part No. Pack of
FIX669 20

Flat Universal



Hole Ø 6

Black Fir Tree Clips
Ø x H: 24 x 18 mm

Part No. Pack of
FIX21 50

VW N989022 Chrysler 6003349
Ford 385661



Hole Ø 7

Light Brown Trim Panel Clips
Ø x H: 25 x 26 mm

Part No. Pack of
FIX693 20

Universal



Hole Ø 6

Grey Panel Clips
Ø x H: 26.5 x 32 mm

Part No. Pack of
FIX244 50

VW 3C0863559 / W70663555W /
W709167SSZUAM
Chrysler 6501916



Hole Ø 6

Black Bonnet Insulation Clips
Ø x H: 28 x 18.5 mm

Part No. Pack of
FIX163 50

GM 1162484 / 90040750



Hole Ø 9

Black Bumper/
Radiator Push-Type Clips
Ø x H: 35 x 25 mm

Part No. Pack of
FIX164 50

PSA 7518N8
Renault 7703077225 / 7703077225



Trim Buttons

Part No. Box of
AB151 220 Pieces

1 x Canoe Clip: FIX1. 1 x Self Pierce: FIX34. 1 x Trim Buttons: FIX35.
2 x Multi-Step: FIX30, FIX33. 3 x Fir-Tree Fixings: FIX20, FIX21, FIX29.



Fir-Tree Fixings

Part No. Box of
AB253 180 Pieces

2 x Trim Buttons: FIX164, FIX163.
4 x Fir-Trees: FIX29, FIX20, FIX21, FIX218.



Drive Rivets

Part No. Box of
AB152 220 Pieces

8 x Sizes: FIX31, FIX39, FIX42, FIX43, FIX44, FIX45, FIX65, FIX66.



Black Trim Panel Push Rivets
W x D x H: 10.5 x 13.5 x 20.5 mm

Part No.	Pack of
FIX414	20

Merc A1249900792



Black Windshield Push Rivets
Ø x S: 11 x 14 mm

Part No.	Pack of
FIX776	20

Mitsubishi MB955901
Toyota 90467-07066
GM 96057847



Black Push Rivets
Ø x S: 12 x 10 mm

Part No.	Pack of
FIX116	50

Merc A1239900092



Black Windshield Push Rivets
W x D x S: 12.5 x 10 x 10 mm

Part No.	Pack of
FIX780	20

VW N90536901

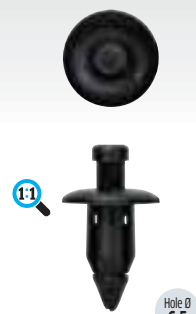

Black Push Rivets
Ø x S: 13 x 8 mm

Part No.	Pack of
FIX760	20

Chrysler 6682401G00
Nissan 6682401G00

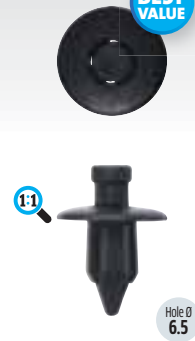

Black Push Rivets
Ø x S: 15 x 9 mm

Part No.	Pack of
FIX510	50

GM 96057846
Mitsubishi MB476821
Suzuki 09409073085PK
Toyota 9046707041

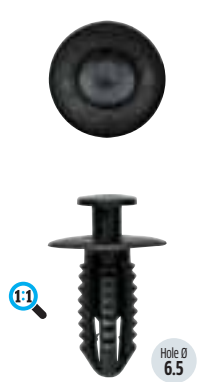

Black Push Rivets
Ø x S: 16 x 18 mm

Part No.	Pack of
FIX759	20

Merc A1249900492



Black Windshield Push Rivets
Ø x S: 14.5 x 27 mm

Part No.	Pack of
FIX775	20

Toyota 90467-09096

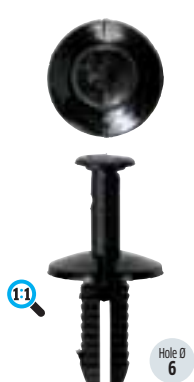

Black Push Rivets
Ø x S: 15 x 15 mm

Part No.	Pack of
FIX107	50

BMW 51111908077
Merc A0009905492

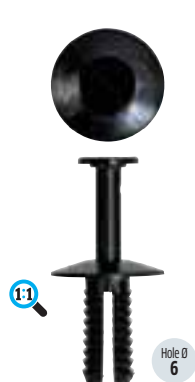

Black Push Rivets
Ø x S: 15 x 15 mm

Part No.	Pack of
FIX111	50

VW N90359101
BMW 51111908077
Merc A0009905492 / A0009905492
/ A1249900492



Black Bumper Push Rivets
Ø x S: 15 x 20 mm

Part No.	Pack of
FIX109	50

BMW 51111964186
GM 1400804



Black Windshield Push Rivets
Ø x S: 16 x 11 mm

Part No.	Pack of
FIX786	20

Subaru 909140012



Black Windshield Push Rivets
Ø x S: 16 x 18 mm

Part No.	Pack of
FIX774	20

Toyota 90467-07146



Black Front Bumper/Boot Push Rivets
Ø x S: 18 x 10 mm

Part No.	Pack of
FIX766	20

Nissan 155309611 / 155310501
Toyota 9046708185



Black Windshield Push Rivets
Ø x S: 18 x 11.5 mm

Part No.	Pack of
FIX781	20

Nissan 8099905N07
Toyota 9046707043 /
9046707043C0 Volvo 987789



Black Bumper Push Rivets
Ø x S: 18 x 13 mm

Part No.	Pack of
FIX257	50



Black Push Rivets
Ø x S: 18 x 13 mm

Part No.	Pack of
FIX512	50

Mitsubishi MR200300





FIX238 Pack of 20
Chrysler 6504521



FIX764 Pack of 20
Toyota 5216120010



FIX511 Pack of 50
Hole Ø 8.5



FIX112 Pack of 50
BMW 51118174185



FIX513 Pack of 50
BMW 51118174185
GM 9046710161150 / 94858299
Honda 156056A003
Mazda E4T68865A
Mitsubishi MU480150
Suzuki 3568481A10

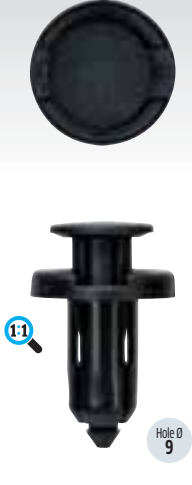

FIX753 Pack of 20
Honda 91503S25003



FIX891 Pack of 20
Ford 4855809
GM 11589289 / 6508863AA



FIX178 Pack of 20
Honda 91501S23003



FIX514 Pack of 50
Honda 91501S23003



FIX637 Pack of 20
Toyota 5325920030



FIX758 Pack of 20
Honda 915453E0003
Nissan 0155304233 / 6384801G00
Toyota 6777152010B1
Volvo 3541113



FIX231 Pack of 20
Honda 91503S23003 / 9150559A003



FIX180 Pack of 20
Honda 91512SX0003



FIX258 Pack of 50
PSA 71741883
Suzuki 0940907332000
Toyota 9046707164



FIX769 Pack of 20
Honda 91512SX0003



FIX273 Pack of 50
PSA 856553
Renault 1609267280



FIX508 Pack of 50
PSA 7013J0 / 8211MV



FIX765 Pack of 20
Honda 91503S7A003



Black Front Bumper Push Rivets
Ø x S: 20 x 13 mm

Part No.	Pack of
FIX768	20
Nissan 1129AG000 / 915035Z3003	



Black Push Rivets
Ø x S: 20 x 5 mm

Part No.	Pack of
FIX113	50
BMW 51481938725	



Black Push Rivets
Ø x S: 20 x 14 mm

Part No.	Pack of
FIX114	50
BMW 51471911992 Merc A2019900292 Mitsubishi M8201411 Volvo 30820141	



Black Push Rivets
Ø x S: 20 x 14 mm

Part No.	Pack of
FIX506	50
BMW 51471911992 Merc A2019900292 Mitsubishi M8201411 Volvo 30820141	



Black Windshield Push Rivets
Ø x S: 20 x 20.5 mm

Part No.	Pack of
FIX779	20
Merc A1269900192	



Black Push Rivets
Ø x S: 20 x 7.5 mm

Part No.	Pack of
FIX403	20
Ford 1738233	



Black Engine Under Cover Push Rivets
Ø x S: 20 x 11 mm

Part No.	Pack of
FIX763	20
Toyota 9046707201	



Black Windshield Push Rivets
Ø x S: 20 x 12.5 mm

Part No.	Pack of
FIX772	20
Subaru 59114AG000	

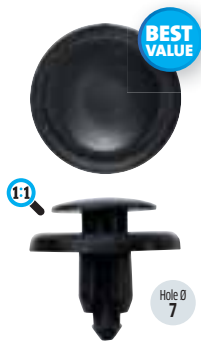

Black Push Rivets
Ø x S: 20 x 8 mm

Part No.	Pack of
FIX509	50



Black Push Rivets
Ø x S x H: 20 x 8 x 22 mm

Part No.	Pack of
FIX754	20
Nissan 6384801G00 Volvo 3541113	



Black Bumper Push Rivets
Ø x S: 20 x 9 mm

Part No.	Pack of
FIX240	50
Mitsubishi MR328954 Nissan 0155309231 Toyota 9004468320	

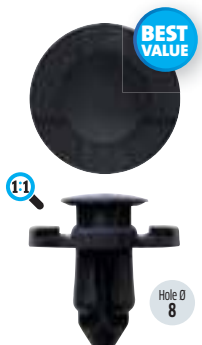

Black Push Rivets
Ø x S: 20 x 9 mm

Part No.	Pack of
FIX507	50



Black Push Rivets
Ø x S: 20 x 21 mm

Part No.	Pack of
FIX751	20
VW 8E0825267 Chrysler 6503598 Ford 1039463 / N8073895 GM 21030249 Land Rover ANR2224 Renault 7701049271	



Black Windshield Push Rivets
Ø x S: 20 x 9 mm

Part No.	Pack of
FIX771	20
Toyota 9046707214	



Black Bumper Push Rivets
Ø x S: 20 x 20 mm

Part No.	Pack of
FIX110	50
VW N90359101 GM 1400806 / 90508809	



Black/Light Grey Roof Trim Push Rivets
Ø x S: 24 x 30 mm

Part No.	Pack of
FIX756	20
Ford E866241SS2M	



Grey Push Rivets
Ø x S: 27 x 19 mm

Part No.	Pack of
FIX651	20
Mercedes-Benz	





Hole Ø 6.5

Black Drive Rivets
W x D x S: 10 x 22 x 9 mm

Part No.	Pack of
FIX65	50
VW 811807447	



Hole Ø 8

Black Drive Rivets
W x D x S: 12 x 17.5 x 7 mm

Part No.	Pack of
FIX66	50
VW 171853695A	



Hole Ø 3.5

Black Drive Rivets
Ø x S: 4.8 x 6 mm

Part No.	Pack of
FIX88	50



Hole Ø 4

Black Drive Rivets
Ø x S: 7.6 x 8 mm

Part No.	Pack of
FIX42	50
PSA 697224 / 9608351380 Renault 7703072224 Eurocode 6539ASSH	



Hole Ø 3.5

Black Drive Rivets
Ø x S: 8 x 7 mm

Part No.	Pack of
FIX91	50



Hole Ø 5

Black Drive Rivets
Ø x S: 8.7 x 8 mm

Part No.	Pack of
FIX43	50
GM 167935 Merc A0009900392 / A0009902292 PSA 7903072116 Renault 7703072173	

BEST SELLER



Hole Ø 6

Black Drive Rivets
Ø x S: 9.5 x 12 mm

Part No.	Pack of
FIX44	50

BEST VALUE



Hole Ø 5

Black Drive Rivets
Ø x S: 10 x 12 mm

Part No.	Pack of
FIX515	50
VW 1L0853934 / N0385012 / N10259301 BMW 51161881149 Merc A0009903492 PSA 77030721 / 7903072170 Renault 7703072116	



Hole Ø 5

Black Drive Rivets
Ø x S: 10 x 14 mm

Part No.	Pack of
FIX174	50
Renault 7703072144	



Hole Ø 6.5

Black Drive Rivets
Ø x S: 11 x 12 mm

Part No.	Pack of
FIX94	50



Hole Ø 5

Black Drive Rivets
Ø x S: 11.4 x 7 mm

Part No.	Pack of
FIX95	50
GM 167935 PSA 7903072116 Renault 7703072173 Volvo 947098	

BEST SELLER



Hole Ø 8

Black Drive Rivets
Ø x S: 12.5 x 12 mm

Part No.	Pack of
FIX98	20
VW N0385501 Ford 7200671 PSA 781424	



Hole Ø 8

Black Drive Rivets
Ø x S: 13 x 13 mm

Part No.	Pack of
FIX45	50
Land Rover 79086L	



Hole Ø 8

Black Underide Guard
Drive Rivets Ø x S: 13 x 15 mm

Part No.	Pack of
FIX106	20
GM 90356928 Merc A0009903792	



Hole Ø 6

Black Drive Rivets
Ø x S: 16 x 11 mm

Part No.	Pack of
FIX103	50
VW N10219501 / N10219502 Ford 1009164 GM 2317703 / 90116376 Merc A0009905592 Volvo 3923475	

BEST SELLER



Hole Ø 8

Black Drive Rivets
Ø x S: 16 x 10 mm

Part No.	Pack of
FIX104	50
GM 1719245 / 90138810	



Hole Ø 8

Black Drive Rivets
Ø x S: 16 x 11 mm

Part No.	Pack of
FIX100	50
VW 16186729901C / N038549101C / BMW 1916670 Ford E8440525 GM 1104880 / 90087290 Merc A0009902992 Volvo 35126242 / 94530507	



Black Drive Rivets
Ø x S: 16 x 13 mm

Part No.	Pack of
FIX39	50



Black Drive Rivets
Ø x S: 16 x 13 mm

Part No.	Pack of
FIX517	50

VW 16186729901C / N038549101C
/ N0385494
BMW 1916670
Ford E8440525
GM 1104880 / 90087290
Merc A0009902992
PSA 697324
Volvo 35126242 / 94530507



Black Panel Drive Rivets
Ø x S: 16 x 14 mm

Part No.	Pack of
FIX709	20

Volvo 91334177

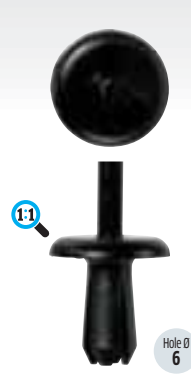

Black Drive Rivets
Ø x S: 16 x 14 mm

Part No.	Pack of
FIX175	50

Merc A0009904529
PSA 79030721 / 740760
Volvo 12681763



Black Drive Rivets
Ø x S: 16.5 x 14 mm

Part No.	Pack of
FIX516	50

Merc A0009904529
PSA 79030721 / 12688176 / 740760
Volvo 12681763



Black Drive Rivets
Ø x S: 18 x 17 mm

Part No.	Pack of
FIX99	50

VW 171885767
Merc A0019944145



Black Drive Rivets
Ø x S: 18.7 x 15 mm

Part No.	Pack of
FIX176	20

GM 1104882 / 90450482
Merc A0019901692



Black Bumper Drive Rivets
Ø x S: 20 x 15 mm

Part No.	Pack of
FIX105	50

BMW 51111944537



Black Drive Rivets
Ø x S: 20 x 24 mm

Part No.	Pack of
FIX177	20

VW 8L0807300



BAHCO Trim Clip Tool

Blade made of high performance alloy steel. Hardness: 40-46 HRC.

Part No.	Qty	Shaft Length	Overall Length
TL125	1	175 mm	245 mm

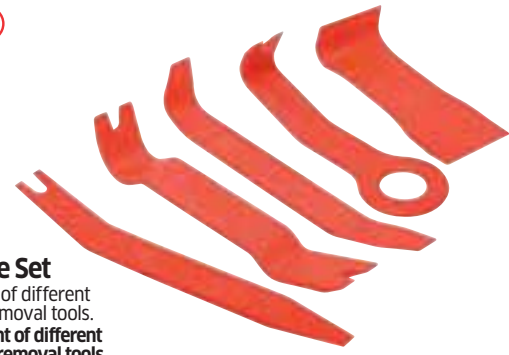

KS TOOLS Plastic Wedge Set

Useful assortment of different wedges and clip removal tools.

- Useful assortment of different wedges and clip removal tools.
- Ideal for removal of paneling, trims and window trims, at the same time, reducing paint work damage: e.g. plastic trims, internal door paneling, plugs, protective caps, actuation knobs etc.

Part No.	Qty	Description
K911.8120	1 Set	5 Piece Set

1 x Standard clip remover. 1 x Trim wedge, narrow model. 1 x Dual clip remover. 1 x Bumper trim wedge, wide model. 1 x Clip remover.





1:1

Hole Ø 7

Black Screw-Type Rivets
W x D x S: 15 x 8 x 15 mm

Part No.	Pack of
FIX124	20
BMW 51131885399	

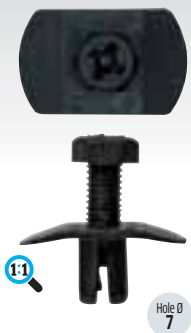

1:1

Hole Ø 7

Black Fender Fasteners
W x D x S: 22 x 14 x 9 mm

Part No.	Pack of
FIX801	20
Isuzu 89422-11500 Nissan 63844-D0100	



1:1

Hole Ø 5

Black Screw-Type Rivets
Ø x S: 11 x 18 mm

Part No.	Pack of
FIX119	50



1:1

Hole Ø 5

Black Screw-Type Rivets
Ø x S: 12 x 11 mm

Part No.	Pack of
FIX117	50
Merc A0009904092 / A1249900592 / A1249909051	



1:1

Hole Ø 5.5

Black Screw Rivets
Ø x S: 12 x 14 mm

Part No.	Pack of
FIX806	20
PSA 6991F0 / 9630090980 Renault 7703072261 / 99950761640	

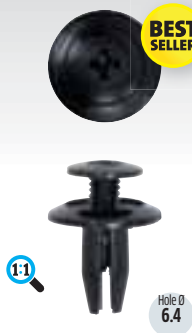

1:1

Hole Ø 6.4

Black Screw-Type Rivets
Ø x S: 15 x 13 mm

Part No.	Pack of
FIX31	50
GM 94198687 Honda 904675A6003 Mazda N30413356A Toyota 9046706017	

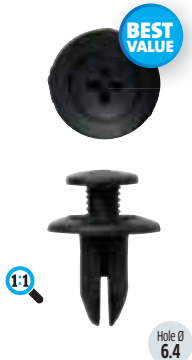

BEST VALUE

1:1

Hole Ø 6.4

Black Screw-Type Rivets
Ø x S: 15 x 13 mm

Part No.	Pack of
FIX522	50
GM 94198687 Honda 904675A6003 Hyundai KK37668868 Isuzu 8942981190 Mazda N30413356A Nissan 1099830880 Toyota 9046706017	



1:1

Hole Ø 6

Black Bumper Liner Screw-Type Rivets
Ø x S: 15 x 13 mm

Part No.	Pack of
FIX794	20
GM 94530438 Mitsubishi MB344728 Nissan 65810AD20	



1:1

Hole Ø 7.5

Black Lining Clips
Ø x S: 15 x 14 mm

Part No.	Pack of
FIX807	20
Honda 90687-SB0-003 / 90687-SB0-013 / 91550-SH3-003	



BEST VALUE

1:1

Hole Ø 6

Black Screw-Type Rivets
Ø x S: 15 x 17 mm

Part No.	Pack of
FIX518	50
Ford 1007932 / 96SG16K262 / W703915SSYYB6	

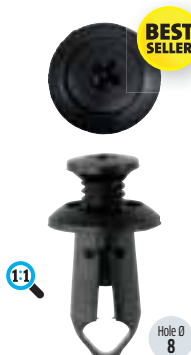

BEST SELLER

1:1

Hole Ø 8

Black Screw-Type Rivets
Ø x S: 15 x 19 mm

Part No.	Pack of
FIX120	50
Chrysler 6503163 Ford W7062645300 GM 10053182	

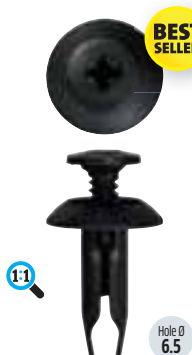

BEST SELLER

1:1

Hole Ø 6.5

Black Screw-Type Rivets
Ø x S: 15.5 x 23 mm

Part No.	Pack of
FIX121	50
Chrysler 6502871 Ford N8039465 / 1354124	

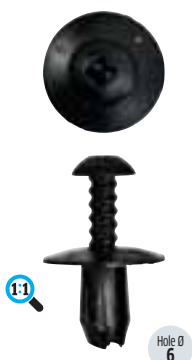

1:1

Hole Ø 6

Black Screw-Type Rivets
Ø x S: 16 x 12 mm

Part No.	Pack of
FIX118	50
Merc A1239900592 Volvo 3120254	

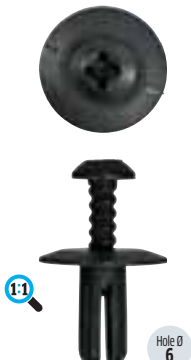

1:1

Hole Ø 6

Black Screw-Type Rivets
Ø x S: 16 x 14 mm

Part No.	Pack of
FIX126	20



1:1

Hole Ø 6

Black Screw-Type Rivets
Ø x S: 16 x 17 mm

Part No.	Pack of
FIX236	20
Chrysler 10139822 / 6508197AA Ford 1007932 / 1673046 / 96SG16K262 Ford W703915SSYYB6	

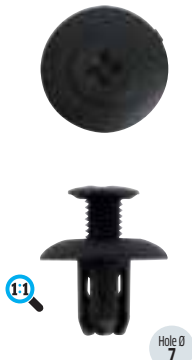

1:1

Hole Ø 7

Black Bumper Screw-Type Rivets
Ø x S: 17 x 11 mm

Part No.	Pack of
FIX234	20
Mitsubishi MB253964 Toyota 90467-07030	

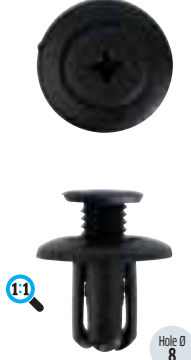

1:1

Hole Ø 8

Black Bumper Screw-Type Rivets
Ø x S: 18 x 13 mm

Part No.	Pack of
FIX232	20
Ford MB45556143 Hyundai 0G03250037A / 8659028000 Mazda B09251833	



1:1

Hole Ø 8.5

White Bumper Clips
Ø x S: 18 x 13 mm

Part No.	Pack of
FIX796	20
Ford MB-455-56143 Mazda B092-51-833 Hyundai 0G032-50037A	

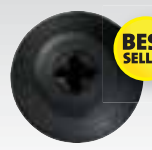
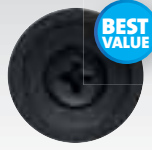

Hole Ø 8

Hole Ø 8

Hole Ø 6

Hole Ø 10

Hole Ø 7.5

Hole Ø 6.5

Beige Bumper Screw-Type Rivets
Ø x S: 18 x 13 mm

Black Screw-Type Rivets
Ø x S: 18 x 13 mm

Black Screw-Type Rivets
Ø x S: 18 x 10 mm

Black Trim Panel Clips
Ø x S: 18 x 18.5 mm

Black Push Type Clips
Ø x S: 18 x 22 mm

Black Screw-Type Rivets
Ø x S: 18 x 23 mm

Part No. Pack of
FIX795 20

Part No. Pack of
FIX520 50

Part No. Pack of
FIX519 50

Part No. Pack of
FIX804 20

Part No. Pack of
FIX359 20

Part No. Pack of
FIX122 50

Ford MB-455-56143
Mazda B092-51-833
Nissan 01553-00380
Hyundai 0G032-50037A /
85325-210005

Hyundai 8659028000
Mazda B09251833

Honda 906885B0003

Merc A1269900392

Honda 905055M4003

Chrysler 10139822 / 6508197AA
Ford 1007932 / 1673046



Hole Ø 8

Hole Ø 8

Hole Ø 8

Hole Ø 8

Hole Ø 8

Hole Ø 8

Light Grey Trim Panel Clips
Ø x S: 18 x 12 mm

Black Trim Panel Clips
Ø x S: 18 x 12 mm

Black Bumper Screw-Type Rivets
Ø x S: 19 x 11 mm

Black Screw-Type Rivets
Ø x S: 20 x 20 mm

Black Screw-Type Rivets
Ø x S: 20 x 8 mm

Black Screw-Type Rivets
Ø x S: 20 x 8 mm

Part No. Pack of
FIX792 20

Part No. Pack of
FIX793 20

Part No. Pack of
FIX233 20

Part No. Pack of
FIX523 50

Part No. Pack of
FIX181 20

Part No. Pack of
FIX123 50

VW 701867299 / 7018672991VZ

VW 70186729901C

Ford MB25556143
Honda 906755B3003
Hyundai 0G03250037A /
8659028000
Mazda FB0156964
Nissan 6387695596 / B09251833

Land Rover AWR3994
Mazda NAO156145
Nissan 6384401A00 /
6385401A00 / 6387801E10

Honda 906755B003
Nissan 75521611000

Honda 906755B003
Nissan 75521611000



Drive Rivets

Part No. Box of
AB152 220 Pieces

8 x Sizes: FIX31, FIX39, FIX42, FIX43, FIX44, FIX45, FIX65, FIX66.



Screw-Type Rivets

Part No. Box of
AB172 130 Pieces

8 x Sizes: FIX31, FIX117, FIX118, FIX119, FIX120, FIX121, FIX122, FIX123.



Locking Nuts

Part No. Box of
AB153 220 Pieces

3 x Round: FIX9, FIX28, FIX38. 1 x Reverse Round: FIX71. 1 x Square: FIX23. 1 x Square Reverse: FIX22. 2 x Large Locking Nuts: FIX73, FIX74.





BEST SELLER



BEST VALUE



Hole Ø 10

Black Screw-Type Rivets
Ø x S: 20 x 14 mm

Part No. Pack of
FIX182 10

BMW 7887508000
Honda 91503SP0003 / 91503SP0003
Land Rover DVQ100230
Mazda FB0156964
Nissan 6387695596
Toyota 94530623



Hole Ø 10

Black Screw-Type Rivets
Ø x S: 20 x 14 mm

Part No. Pack of
FIX521 50



Hole Ø 10

Black Screw-Type Rivets
Ø x S: 20 x 26 mm

Part No. Pack of
FIX216 20

Honda 91502SP0003



Hole Ø 8

Black Screw Type Rivets
Ø x S: 23 x 16 mm

Part No. Pack of
FIX798 20

VW 8541ASCHB



Hole Ø 11

Black Screw Type Rivets
Ø x S: 25 x 14 mm

Part No. Pack of
FIX797 20



Hole Ø 7.8

Black Expansion Rivets
Ø x S: 30 x 17 mm

Part No. Pack of
FIX802 10

Merc A0019900192



Trim Clip Workshop Kit

Contains 1,800 trim clips.
Caters for most vehicle applications.

Part No.	Qty	Description
MKIT1	1 Kit	Trim Clip Workshop Kit

1 x Louvred Panel (W x H): 457 x 946 mm (SB35). 36 x Storage Bins (D x W x H): 165 x 100 x 75 mm Blue (SB21BU). 36 x Trim Clips: FIX500 - FIX535 (Packs of 50); 6 x Trim Buttons - Fir-Tree. 6 x Screw Rivets. 9 x Push Rivets. 3 x Drive Rivets. 3 x Locking Nuts. 9 x Panel Clips.



BEST SELLER

BAHCO Trim Clip Tool

Blade made of high performance alloy steel. Hardness: 40-46 HRC.

Part No.	Qty	Shaft Length	Overall Length
TL125	1	175 mm	245 mm

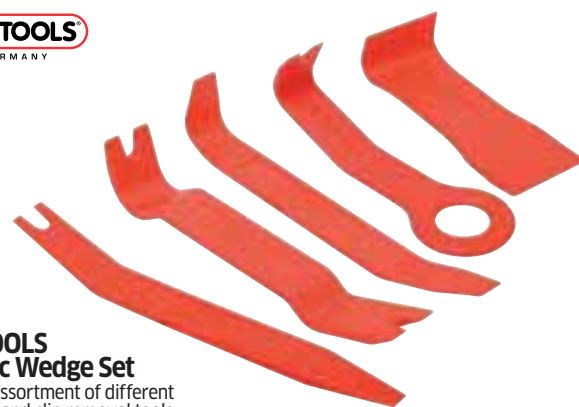

KS TOOLS Plastic Wedge Set

Useful assortment of different wedges and clip removal tools.

- Useful assortment of different wedges and clip removal tools.
- Ideal for removal of paneling, trims and window trims, at the same time, reducing paint work damage: e.g. plastic trims, internal door paneling, plugs, protective caps, actuation knobs etc.

Part No.	Qty	Description
K911.8120	1 Set	5 Piece Set

1 x Standard clip remover. 1 x Trim wedge, narrow model. 1 x Dual clip remover. 1 x Bumper trim wedge, wide model. 1 x Clip remover.



**Actual Size
Images**

Trim Clip Chart

Double sided A1 size guide,
folded down to A4 for easy and convenient use.

If displaying range on a wall two copies will be required.

- Contains 330 popular trim clips, body screws, number plate screws and rivets
- New larger format A1 size chart
- Actual size images for quick and easy identification

Part No.	Qty	Description
YCHART1	1	A1 Double Sided Wall Chart



**Search for
Trim Clips by
OEM Ref - See
Page 185**



Natural Locking Nuts
W x H: 9.5 x 8 mm

Part No. Pack of
FIX23 50



Natural Locking Nuts
W x H: 9.5 x 12 mm

Part No. Pack of
FIX22 50



Natural Locking Nuts
Ø x H: 9 x 9.5 mm

Part No. Pack of
FIX524 50
VW 155809966
Fiat 14115980 PSA 6992G2



Natural Locking Nuts
W x H: 9 x 12 mm

Part No. Pack of
FIX72 50



Black Locking Nuts
Ø x H: 12 x 14 mm

Part No. Pack of
FIX71 50
VW 6N0809966A / 867809966



Black Locking Nuts
W x D x H: 12 x 7 x 12 mm

Part No. Pack of
FIX134 50
VW 81180757C



Salmon Locking Nuts
W x D x H: 12 x 12 x 9 mm

Part No. Pack of
FIX740 20
Fiat 142215088



Natural Locking Nuts
W x H: 11 x 12 mm

Part No. Pack of
FIX142 50
GM 1216957 / 90230960



Black Round Locking Nuts
Ø x H: 13 x 8 mm

Part No. Pack of
FIX9 50



Natural Locking Nuts
Ø x H: 12.5 x 11 mm

Part No. Pack of
FIX28 50



Yellow Locking Nuts
W x H: 14 x 8 mm

Part No. Pack of
FIX190 50
Toyota 9018906018



Natural Round Locking Nuts
Ø x H: 16.5 x 11 mm

Part No. Pack of
FIX221 50
Toyota 9018906006



Natural Locking Nuts
Ø x H: 16 x 11 mm

Part No. Pack of
FIX525 50



Natural Round Locking Nuts
Ø x H: 16 x 9 mm

Part No. Pack of
FIX38 50



White Locking Nuts
Ø x H: 14.3 x 16 mm

Part No. Pack of
FIX191 20
BMW 51127046911
Honda 906726718110M1 / 91620SR2003
Hyundai 9751922000



Natural Locking Nuts
Ø x H: 16 x 20 mm

Part No. Pack of
FIX73 50
VW 321813998A
Honda 906726718111M
Toyota 9018904013



White Push Type Clips
Ø x H: 17.5 x 17.5 mm

Part No. Pack of
FIX747 20
Mitsubishi MB098145 / MU480033
Toyota 9018906001



Natural Locking Nuts
Ø x H: 22 x 21 mm

Part No. Pack of
FIX74 50
Ford 1007902 / 1659672



Black Fender Screw Grommets
Ø x H: 16 x 20 mm

Part No. Pack of
FIX749 20
GM 94854203
Toyota 9018906224



Black Locking Nuts
Ø x H: 20 x 18.5 mm

Part No. Pack of
FIX192 50
Toyota 9018906013



Black Locking Nuts
Ø x H: 20 x 18.5 mm

Part No. Pack of
FIX526 50
Toyota 9018906013



Black Locking Nuts
Ø x H: 15 x 14 mm

Part No. Pack of
FIX135 50
VW N90833801



Black Locking Nuts
Ø x H: 16 x 21 mm

Part No. Pack of
FIX137 20
VW 357827998



Black Locking Nuts
Ø x H: 15 x 21.5 mm

Part No. Pack of
FIX136 50
VW N90821401



1:1 Hole Ø 9

Grey Locking Nuts
Ø x H: 16 x 25 mm

Part No. Pack of
FIX138 50
VW 357868143



1:1 Hole Ø 10

Black Locking Nuts
Ø x H: 18 x 21 mm

Part No. Pack of
FIX139 20
VW 357827998A / 357827998A



1:1 Hole Ø 10

Black Locking Nuts
Ø x H: 18 x 25 mm

Part No. Pack of
FIX145 20
GM 1406984 / 90482706



1:1

Black Locking Nuts
W x D x H: 16 x 12 x 15 mm

Part No. Pack of
FIX461 20
Mitsubishi MB083120
Toyota 90189-04008



1:1 Hole Ø 8

Black Locking Nuts
Ø x H: 24 x 10.5 mm

Part No. Pack of
FIX146 50
BMW 51711958025
Merc A2019900050



1:1 Hole Ø 10

Black Locking Nuts
Ø x H: 23 x 18 mm

Part No. Pack of
FIX144 20
GM 1190970 / 90053803



1:1 Hole Ø 11

Black Locking Nuts
Ø x H: 16 x 11 mm

Part No. Pack of
FIX147 50
VW 8E0825265C
BMW 16131176747
GM 180942 / 90413589
Merc A0039900251



1:1 Hole Ø 11

Dark Red Locking Nuts
L x W x H: 17 x 14.5 x 12 mm

Part No. Pack of
FIX26 50
VW 1J0853120



1:1

Black Side Moulding Clips
W x D x H: 15 x 10 x 15.5 mm

Part No. Pack of
FIX746 20
Renault 7703081185



1:1

Natural Moulding Clips
W x D x H: 20 x 13 x 17.5 mm

Part No. Pack of
FIX867 20
PSA 699796
Renault 7703081185



1:1

Black Locking Nuts
W x D x H: 11 x 21 x 17 mm

Part No. Pack of
FIX148 50
BMW 5113810295 / 51138102952
Merc A6389940845



1:1

Clear Plug in Clips
W x D x H: 17 x 15 x 11 mm

Part No. Pack of
FIX481 20
BMW 51418215806



1:1 Hole Ø 8.5

White Grommets
Ø x H: 11 x 14 mm

Part No. Pack of
FIX305 20
Merc A0019887681



1:1

Clear Retaining Clips
W x D x H: 17 x 15 x 15 mm

Part No. Pack of
FIX482 20
BMW 51458161557



1:1

Red Dash Trim Clips
W x D x H: 19 x 17 x 12 mm

Part No. Pack of
FIX483 20
BMW 51458266814



1:1 Hole Ø 5

Natural Friction Bushes
Ø x H: 5 x 12 mm

Part No. Pack of
FIX6 50
VW 113853615 Fiat 4234280
Merc A0009880027
PSA 9629547080



1:1

Black Screw Grommets
W x D x H: 10 x 10 x 15 mm

Part No. Pack of
FIX890 20
BMW 63171967868
Merc A0009881625



1:1 Hole Ø 10

Black Headlight Locking Nuts
Ø x H: 12.5 x 10.5 mm

Part No. Pack of
FIX621 20
Ford N8079945
Nissan N8079945
Toyota 9046712042



1:1 Hole Ø 10

White Headlight Clips
Ø x H: 15 x 10 mm

Part No. Pack of
FIX645 20
Hyundai 92351-37000



1:1 Hole Ø 9

White Headlight Clips
W x D x H: 18.5 x 14 x 15 mm

Part No. Pack of
FIX421 20
VW 191941142



1:1 Hole Ø 6.5

Black Front Logo Clips
Ø x H: 8 x 13 mm

Part No. Pack of
FIX366 20
Renault 7703081151



1:1 Hole Ø 5

Green Moulding Clips
Ø x H: 13 x 12 mm

Part No. Pack of
FIX87 50
VW 1H0853586



1:1 Hole Ø 9

Black Moulding Grommets
Ø x H: 13 x 12.5 mm

Part No. Pack of
FIX340 20
GM 129943



1:1 Hole Ø 11

Beige/Black Grommets
Ø x H: 16 x 17.5 mm

Part No. Pack of
FIX193 50
VW N10516801





White Lining Clips
Ø x H: 11.5 x 12 mm

Part No. Pack of
FIX863 20
GM 0149907 / 90414663



White Mirror Panel Clips
Ø x H: 12 x 16 mm

Part No. Pack of
FIX810 20
Ford 9032112 / 149910



White/Grey Panel Clips
Ø x H: 15 x 14 mm

Part No. Pack of
FIX816 20
Renault 7701050734 / 7703077430



White Moulding Clips
Ø x H: 15 x 19 mm

Part No. Pack of
FIX828 20
Renault 7703077183



White Lining Clips
Ø x H: 15 x 20 mm

Part No. Pack of
FIX880 20
Renault 7703077250



Black Door Panel Clips
Ø x H: 15 x 20.5 mm

Part No. Pack of
FIX856 20
Renault 7703077434
GM 93160780



Grey Lining Clips
Ø x H: 16 x 16 mm

Part No. Pack of
FIX835 20
Merc A0009905792



Black/White Trim Panel Clips
Ø x H: 16 x 19 mm

Part No. Pack of
FIX818 20
Ford 1257376



Blue Panel Clips
Ø x H: 16.5 x 19 mm

Part No. Pack of
FIX846 20
VW 171867299B
Honda 91560-S9A-A01

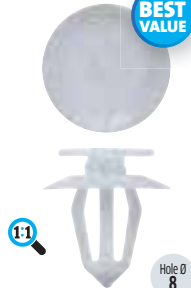

Natural Panel Clips
Ø x H: 17 x 18 mm

Part No. Pack of
FIX527 50
Ford 1008086
GM 2345957 / 2345959 / 90321122
/ 90457899
Toyota 6777102030



Yellow Panel Clips
Ø x H: 17 x 20 mm

Part No. Pack of
FIX831 20
VW 7M0867299K
Ford 1008068 / A310A46-AA



Yellow Panel Clips
Ø x H: 17.5 x 21 mm

Part No. Pack of
FIX167 20
VW 7M0867299K
Ford 1008086 / A310A46AA



White Lining Clips
Ø x H: 17.5 x 21 mm

Part No. Pack of
FIX853 20
Merc A0079899978
Toyota 6777102030



White Panel Clips
Ø x H: 18 x 16 mm

Part No. Pack of
FIX7 50



Natural Panel Clips
Ø x H: 18 x 17 mm

Part No. Pack of
FIX529 50
VW 2730ASCT518
PSA 699156
Renault 7703077469
Eurocode 2730ASCT518



White Inner Door Panel Clips
Ø x H: 18 x 17.5 mm

Part No. Pack of
FIX841 20
Ford 6117693 / E8652205
Merc A0069884378
Mitsubishi M283083



Blue Moulding Clips
Ø x H: 18 x 17.5 mm

Part No. Pack of
FIX838 20
GM 88970345
Toyota 9046710167



White Panel Clips
Ø x H: 18 x 18.5 mm

Part No. Pack of
FIX845 20
Suzuki 940908310
Toyota 6777189104





Blue Panel Clips
Ø x H: 18 x 20 mm

Part No.	Pack of
FIX48	50
Ford 1070107	

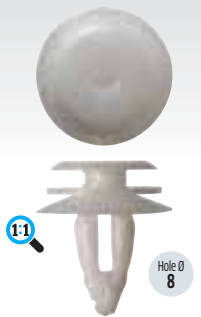

Natural Interior Lining Clips
Ø x H: 18 x 20 mm

Part No.	Pack of
FIX272	50
BMW 51418224768	

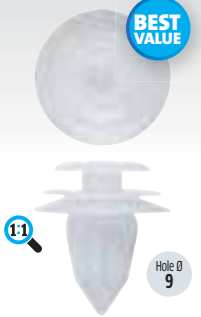

Natural Panel Clips
Ø x H: 18 x 20.5 mm

Part No.	Pack of
FIX531	50
GM 909130115 Toyota 9046710161	

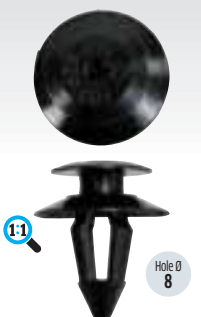

Black Panel Clips
Ø x H: 18 x 21 mm

Part No.	Pack of
FIX160	20
VW 703867299	

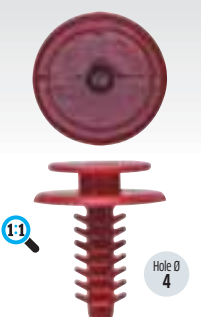

Red Lining Clips
Ø x H: 18 x 22 mm

Part No.	Pack of
FIX824	20
Fiat 46410400 / 500358567	

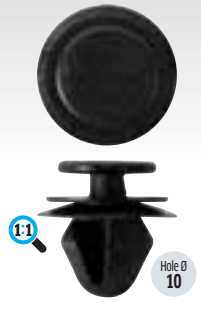

Black Floor Covering Clips
Ø x H: 18.5 x 18 mm

Part No.	Pack of
FIX255	50
PSA 699156 Renault 7703077469	



White Panel Clip
Ø x H: 18.5 x 18 mm

Part No.	Pack of
FIX252	50
PSA 8E9867299 Renault 699156 Eurocode 2730A5CTS18	



Green Lower Panel Clips
Ø x H: 18.5 x 18 mm

Part No.	Pack of
FIX848	20
Merc A0009912771	



White Panel Clips
Ø x H: 18.5 x 20 mm

Part No.	Pack of
FIX530	50
Toyota 6777102030	



Natural Panel Clips
Ø x H: 18.5 x 21 mm

Part No.	Pack of
FIX165	20
Fiat 500326189 Ford 6176723	



Grey Panel Clips
Ø x H: 20 x 19 mm

Part No.	Pack of
FIX37	50
Ford 6117693	



White Panel Clips
Ø x H: 20 x 24 mm

Part No.	Pack of
FIX250	50
VW 6X0867300A PSA 699050	



Green Panel Clips
Ø x H: 18 x 18 mm

Part No.	Pack of
FIX217	50
BMW 51411870718	



Black Panel Clips
Ø x H: 18 x 18.5 mm

Part No.	Pack of
FIX242	50
VW 893867290 GM 2240587 / 2240593 / 90321121	



Black Panel Clips
Ø x H: 18 x 21 mm

Part No.	Pack of
FIX47	50
VW 823867299 Toyota 7504933010	



Yellow Trim Panel Clips
Ø x H: 18 x 20 mm

Part No.	Pack of
FIX812	20
BMW 51418172050	



White Panel Clips
Ø x H: 18 x 21 mm

Part No.	Pack of
FIX528	50
VW 893867290 BMW 51411885961 / 51411973500 BMW 51418224768 Ford SEEFIX528	

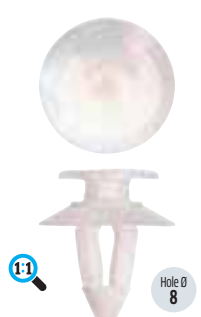

Natural Panel Clips
Ø x H: 18 x 21 mm

Part No.	Pack of
FIX80	50
VW 171867299B / 893867290 BMW 51411885961	





Hole Ø 6

Dark Blue Panel Clips
Ø x H: 16 x 18 mm

Part No.	Pack of
FIX861	20
Honda 90602-TA0-003	



Hole Ø 5.5

Black Panel Clips
Ø x H: 14 x 21 mm

Part No.	Pack of
FIX263	50
Land Rover MWC9134	



Hole Ø 4.7

Blue Door Trim Clips
Ø x H: 14 x 21 mm

Part No.	Pack of
FIX886	20
Land Rover MWC9134	



Hole Ø 8

White Door Trim Panel Clips
Ø x H: 17 x 15.5 mm

Part No.	Pack of
FIX269	50
PSA 699636 Renault 7703077111 Suzuki 09409083085E5	



Hole Ø 10

Black Bumper Clips
Ø x H: 23 x 26 mm

Part No.	Pack of
FIX275	50
BMW 07131480419	

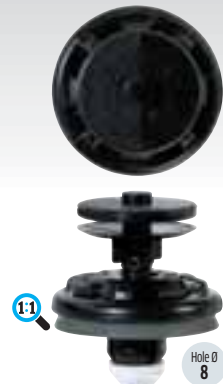

Hole Ø 8

Black Panel Clips
Ø x H: 23 x 27.5 mm

Part No.	Pack of
FIX168	20
VW 6Q0868243	



Hole Ø 10

White/Black Panel Clips
Ø x H: 21.5 x 20 mm

Part No.	Pack of
FIX495	20
Renault 7703077476	



Hole Ø 10

Black Panel Clips
Ø x H: 22 x 22 mm

Part No.	Pack of
FIX83	20
VW 3B0838243	



Hole Ø 10

Black Panel Clips
Ø x H: 27 x 30 mm

Part No.	Pack of
FIX169	20
VW 8E0868243	



Hole Ø 8

Black/White Panel Clips
complete with Housing
Ø x H: 18 x 26 mm

Part No.	Pack of
FIX81	20
VW 6N0868243A	



Hole Ø 9

Brown/White Panel Clips
complete with Housing
Ø x H: 28 x 32 mm

Part No.	Pack of
FIX82	20
VW 1H0868243B	



Hole Ø 6

Black Lining Clips
Ø x H: 19 x 22.5 mm

Part No.	Pack of
FIX819	20
Chrysler 6033862 GM 796255 AMC 4005099	



Hole Ø 3.5

White Steering Clips
Ø x H: 13 x 18 mm

Part No.	Pack of
FIX330	20
Ford YC15B03180AB	



Hole Ø 7.5

White/Black Panel Clips
W x D x H: 15.5 x 15.3 x 16.7 mm

Part No.	Pack of
FIX821	20
Hyundai 87702H1000	



Hole Ø 5

White Bumper Retainer Clips
Ø x H: 16 x 13 mm

Part No.	Pack of
FIX230	20
GM 122920	



Hole Ø 8

White Bumper Trim Clips
Ø x H: 19 x 17 mm

Part No.	Pack of
FIX338	20
PSA 856553 Renault 7703077420 / 7703077421	

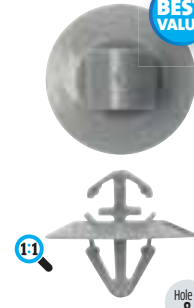

Hole Ø 8

Grey Panel Clips
Ø x H: 19 x 17 mm

Part No.	Pack of
FIX533	50
Fiat 500326896 / 71728806 GM 4409693 / 4412053 / 93160023 Renault 7701470779 / 7703077421	

BEST VALUE

Side Moulding Clips

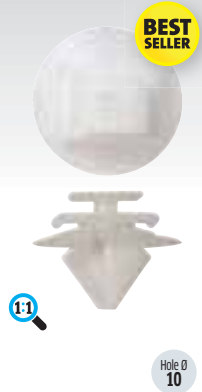

White Panel Clips
 Ø x H: 20 x 16 mm

Part No.	Pack of
FIX166	50
PSA 6539ASCHB / 856540 Renault 7701049270	

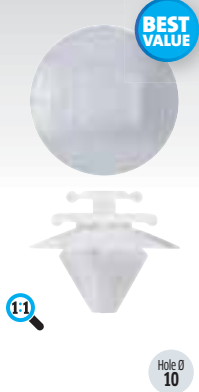

White Panel Clips
 Ø x H: 20 x 16 mm

Part No.	Pack of
FIX532	50
Fiat 71737918 PSA 6539ASCHB / 856540 Renault 7701049270	

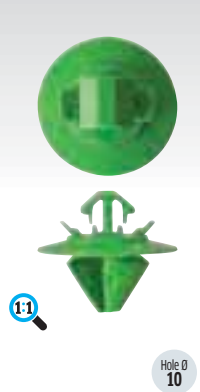

Green Moulding Clips
 Ø x H: 18.5 x 17 mm

Part No.	Pack of
FIX266	50
Fiat 9408565488 PSA 856548	

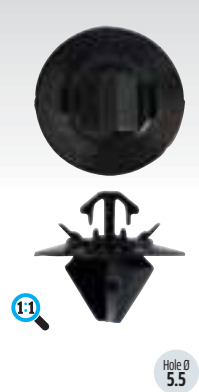

Black Moulding Clips
 Ø x H: 20 x 17.5 mm

Part No.	Pack of
FIX227	50
Fiat 9408565488 PSA 856548	



Orange Moulding Clips
 Ø x H: 17 x 24.5 mm

Part No.	Pack of
FIX837	20
Toyota 9090467036	

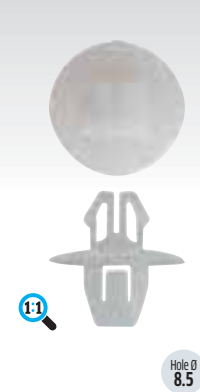

White Moulding Clips
 Ø x H: 18 x 17.8 mm

Part No.	Pack of
FIX228	50
Suzuki 9046711063 Toyota 7539533030 / 7693126010	



White/Black Moulding Clips
 Ø x H: 18 x 22 mm

Part No.	Pack of
FIX49	50
VW 357853575 PSA 6991W4	



Black/Clear Base Panel Clips
 W x D x H: 15 x 6 x 18 mm

Part No.	Pack of
FIX185	20
VW 1H0837719 Ford 106520 / 1065204 GM 157979	



White Side Moulding Clips
 W x D x H: 18 x 16 x 21 mm

Part No.	Pack of
FIX400	20
VW 3C0853586	



White/Black Surround Panel Clips
 Ø x H: 12 x 10.5 mm

Part No.	Pack of
FIX534	50
Fiat 71728806 PSA 856543	



White/Black Washer Panel Clips
 Ø x H: 18 x 14.5 mm

Part No.	Pack of
FIX535	50
Hyundai 877562 / 877562E000	



Light Blue/Black Rocker Panel Clips
 Ø x H: 18 x 19 x 21 mm

Part No.	Pack of
FIX850	20
Hyundai 877583L000	



Natural Bumper Retainer Clips
 W x D x H: 20 x 15 x 17 mm

Part No.	Pack of
FIX237	20
Ford 2T14V35312AB	

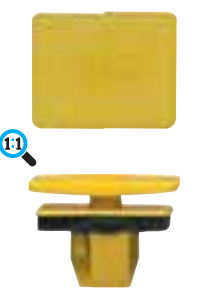

Yellow/Black Rocker Panel Clips
 W x D x H: 20 x 16 x 15 mm

Part No.	Pack of
FIX822	20
Hyundai 877583D000	



Natural Door Lock Rod Clips
 W x D x H: 23 x 9.5 x 18 mm

Part No.	Pack of
FIX462	20
Toyota 6929312050	



Natural Door Linkage Clips
 Ø x H: 9 x 11 mm

Part No.	Pack of
FIX140	50
VW 171837199 Merc A0039885078	

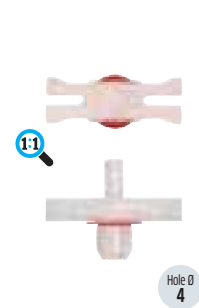

White/Red Washer Moulding Clips
 W x D x S: 18 x 6 x 5 mm

Part No.	Pack of
FIX63	50
VW 113853585C	

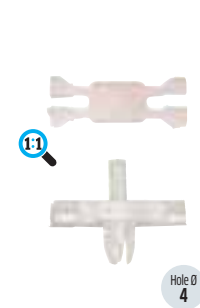

White Moulding Clips
 W x D x S: 18 x 6 x 5 mm

Part No.	Pack of
FIX64	50
VW 113853585C	





White Moulding Clips
W x D x H: 31 x 8.5 x 5 mm

Part No.	Pack of
FIX186	20
VW 191853733A / 6U0853733 / 7603ASCH	



White Moulding Clips
W x D x H: 32 x 10.5 x 6 mm

Part No.	Pack of
FIX187	20
VW 1H0853733B / 8541ASCH	



Yellow Moulding Clips
W x D x H: 35 x 39 x 21 mm

Part No.	Pack of
FIX85	20
VW 1H0853585B	



White/Blue Headlight Clips
W x D x H: 25 x 34 x 16 mm

Part No.	Pack of
FIX417	20
VW 8E0825265C BMW 16131176747 Merc A0039900251 GM 180942 / 90413589	



White Moulding Clips
W x D x H: 41 x 23 x 15 mm

Part No.	Pack of
FIX86	20
VW 1H0853585A	

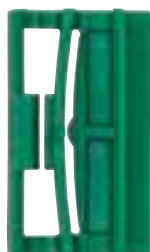

Green Moulding Clips
W x D x H: 19 x 32 x 24 mm

Part No.	Pack of
FIX869	20
BMW 51717066223	



White Door Panel Clips
W x D x H: 48 x 33 x 14 mm

Part No.	Pack of
FIX424	20
Merc A0079887178	



Green/White/Zinc Plated Battery
Terminal Covers - L Shape 2
W x D x H: 54.5 x 16 x 12 mm

Part No.	Pack of
FIX634	10
Merc A2016980660 Eurocode 5328ASCST1B	

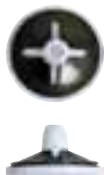

White Badge Fixing Clips
Ø: 12 mm

Part No.	Pack of
FIX67	50
Ford 1053656300	



Black Door Gasket Clips
Ø x H: 6 x 13 mm

Part No.	Pack of
FIX331	20
Ford 1042065 / W7029851042065	



Black Seat Belt Clips
Ø x H: 16 x 5 mm

Part No.	Pack of
FIX411	20



Black Screw Nut
Ø x H: 20 x 21 mm

Part No.	Pack of
FIX354	20
GM 1404960	

Hole Ø
9



Black Door Lock Knobs
Ø x H: 8.5 x 45.5 mm

Part No.	Pack of
FIX436	10
VW 1758371879B9	



Black Bonnet Buffers
Ø x H: 18 x 30 mm

Part No.	Pack of
FIX32	20
VW HNA5373BA Ford AAU5486A	

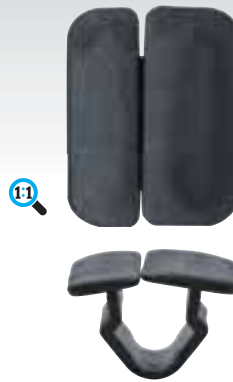

Black Seal Clips
W x D x H: 23 x 29 x 15 mm

Part No.	Pack of
FIX325	20
VW 1H586384901C / 867863849A01C	



Black Floor Mat Twist Lock Clips
Clip/Washer Ø x H: 18.3 x 25 mm

Part No.	Pack of
FIX219	20 Pairs
BMW 51471881521 / 82119410191	

Hole Ø
20



Black Thumb Screw Nuts
W x D x H: 25 x 25 x 17 mm

Part No.	Pack of
FIX640	10
BMW 71111179445	

Black Gloss Boot Lid Thumb Screw
W x D x H: 45.5 x 23 x 32 mm

Part No.	Pack of
FIX639	5
BMW 71111179444	



Black Fender Clips
W x D x H: 32 x 31 x 12 mm

Part No.	Pack of
FIX471	20
Nissan 6384835F00 / 63848D400 Toyota 5378914010	



Black Fender Bumper Clips
W x D x H: 34.5 x 25 x 18.5 mm

Part No.	Pack of
FIX407	20
Toyota 5387958010	



Black Moulding Clips
W x D x H: 20.5 x 12 x 22 mm

Part No.	Pack of
FIX384	20
Ford FCP-0180	



Black Cover Plugs
Ø x H: 22 x 10.5 mm

Part No.	Pack of
FIX490	20
VW 1H0837111AB41	

Hole Ø
15



Black Bonnet Insulator Clips
Ø x H: 24.5 x 18.5 mm

Part No.	Pack of
FIX434	20
VW 701863841	



Black Plastic Nut Star
Ø x H: 22 x 6 mm

Part No.	Pack of
FIX360	20
PSA 055389000	





Hole Ø
6

1:1 Grey Omega Clips
Ø: 8 mm

Part No. Pack of
FIX52 50

Fiat 14569680
PSA 7903079004
Renault 7703079070



Hole Ø
6

1:1 Green Omega Clips
Ø: 11 mm

Part No. Pack of
FIX53 50

Fiat 1456980



Hole Ø
6

1:1 Pink Omega Clips
Ø: 13 mm

Part No. Pack of
FIX54 50



Hole Ø
6

1:1 Blue Omega Clips
Ø: 14 mm

Part No. Pack of
FIX55 50



Hole Ø
6

1:1 White Omega Clips
Ø: 17 mm

Part No. Pack of
FIX56 50



Hole Ø
6

1:1 Yellow Omega Clips
Ø: 24 mm

Part No. Pack of
FIX57 50



Hole Ø
10

Black Bonnet Rod Clips
W x D x H: 20 x 20 x 29 mm

Part No. Pack of
FIX458 20

Hyundai 811741G000
Toyota 5345514020



1:1

Black Bonnet Rod Clips
Ø x H: 16 x 23 mm

Part No. Pack of
FIX624 20

Universal



1:1

Natural Bonnet Rod Clips
W x D x H: 17 x 17 x 25 mm

Part No. Pack of
FIX382 20

Toyota 5345514020



1:1

Hole Ø
7.6

White Bonnet Rod Clips
Ø x H: 16.5 x 26 mm

Part No. Pack of
FIX363 20

Universal



1:1

Hole Ø
7.6

Black Gloss Bonnet Rod Clips
Ø x H: 16.5 x 26 mm

Part No. Pack of
FIX369 20



1:1

Black Bonnet Rod Clips
W x D x H: 13 x 14.5 x 24 mm

Part No. Pack of
FIX335 20

Fiat 46789809



1:1

Natural Bonnet Rod Clips
W x D x H: 15.5 x 15.5 x 24 mm

Part No. Pack of
FIX477 20

Toyota 9095901136



1:1

Natural Brake Pipe
& Petrol Pipe Clips
Pipes Ø: 4 & 8 mm

Part No. Pack of
FIX69 50

Ford 6482170



1:1

White Pipe/Cable Clips
Pipe Ø: 4.8 (x 2) mm

Part No. Pack of
FIX76 50



1:1

White Pipe/Cable Clips
Pipe Ø: 6.4 (x 2) mm

Part No. Pack of
FIX77 50



1:1

White Pipe/Cable Clips
Pipe Ø: 7.9 (x 2) mm

Part No. Pack of
FIX78 50



1:1

White Bonnet Rod Clips
W x D x H: 22 x 14 x 21 mm

Part No. Pack of
FIX361 20

PSA 9605204680

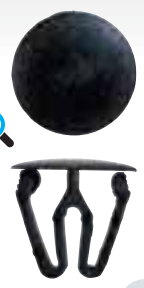

Hole Ø
9.5-13.5

Black Hole Plugs
Ø x H: 16.7 x 16 mm

Part No.	Pack of
FIX1013	50
Universal	



Hole Ø
14-21

Black Hole Plugs
Ø x H: 24.8 x 17 mm

Part No.	Pack of
FIX1421	50
Universal	



Hole Ø
22-30

Black Hole Plugs
Ø x H: 34.8 x 17 mm

Part No.	Pack of
FIX2230	50
Universal	



White Panel Fixing Cable Ties
Tie W x L: 4.5 x 200 mm

Part No.	Pack of
FIX859	20

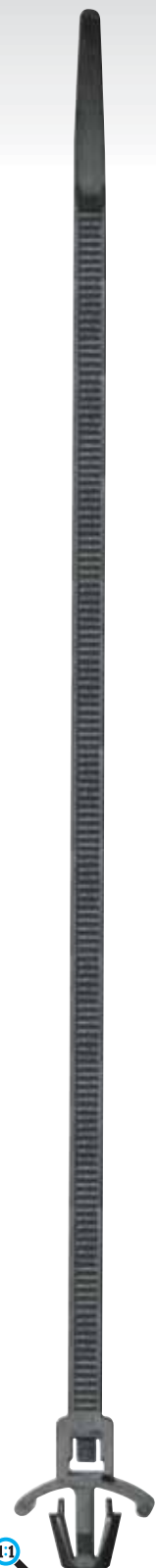

Black Panel Fixing Cable Ties
Width x Length 4.6 x 215 mm

Part No.	Pack of
ECT23	100



Black Panel Fixing Cable Ties
Width x Length: 5.0 x 170 mm

Part No.	Pack of
ECT25	100



Black Cable Fixings
W x L: 18 x 95 mm

Part No.	Pack of
FIX50	50
Ford 389358	



Black Cable Harness Clips
W x H x D: 30 x 43 x 20 mm

Part No.	Pack of
FIX60	50

Assorted Pack of Pipe/Cable Clips

Part No.	Pack of
AP60	35 Pieces
3 x Types: FIX76, FIX77, FIX78.	



Plastic Rivets

Black plastic.



Black Standard Flange Plastic Rivets

Head Ø x Length: 5 x 22 mm

Part No. Pack of

FIX209 50

Chrysler 6500898

Black Standard Flange Plastic Rivets

Head Ø x Length: 6 x 25 mm

Part No. Pack of

FIX210 50

Chrysler 25524005 / 6501559 / 6506007AA
Ford N803862S
GM 10184895

Black Large Flange Plastic Rivets

Head Ø x Length: 6 x 25 mm

Part No. Pack of

FIX211 50

Chrysler 6503860
Ford N8030433 / N803043S / N804675S
GM 10036503 / 14063981 / 6500911

Black Large Flange Plastic Rivets

Head Ø x Length: 7 x 17.5 mm

Part No. Pack of

FIX212 20

Black Large Flange Plastic Rivets

Head Ø x Length: 6 x 19 mm

Part No. Pack of

FIX213 50

BMW 51717002953



Aluminium Trim Clip Rivets

Ø: 2.4 mm

Part No. Pack of

FIX70 50

Ford 6028434 GM 164361 / 90033713

Aluminium/Black Plastic Flange Body Trim Rivets

Head Ø: 4 mm

Part No. Pack of

FIX206 50

Volvo 979878

Aluminium/Black Plastic Cover Body Trim Rivets

Head Ø: 6 mm

Part No. Pack of

FIX207 50

Ford 1041415 / W7044395 / W709095533

Black Rivet

Plastic Ø x Rivet L: 14 x 30 mm

Part No. Pack of

FIX712 10

PSA 6973A4



Looking for Regular Rivets?

Full range of Standard Rivets and Tools start from page 151

Audi • VW • Seat • Škoda



1H0853585A
FIX323 Pack of 20
W x D x H: 39 x 22 x 18,5



1H0853585A
FIX86 Pack of 20
W x D x H: 41 x 23 x 15



1H0853585B
FIX85 Pack of 20
W x D x H: 35 x 39 x 21

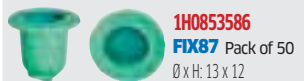

1H0853586
FIX87 Pack of 50
Ø x H: 13 x 12



1H0853733B
FIX187 Pack of 20
W x D x H: 32 x 10,5 x 6



1H0868243A
FIX82 Pack of 20
Ø x H: 28 x 32



1H0868243B
FIX857 Pack of 20
Ø x H: 28 x 31



1J0853120
FIX26 Pack of 50
L x W x H: 17 x 14,5 x 12



1J6867276
FIX630 Pack of 20
W x D x H: 15,5 x 9 x 25



1L0853934
FIX97 Pack of 50
Ø x S: 10 x 12



1L0853934
FIX15 Pack of 50
Ø x S: 10 x 12



1M0854541A
FIX607 Pack of 20
W x D x H: 16 x 16 x 10



1M0854719A
FIX608 Pack of 20
W x D x H: 13 x 15 x 13,5



251823717
FIX61 Pack of 50
W x D x H: 13 x 5 x 11



2730ASCTS1B
FIX529 Pack of 50
Ø x H: 18 x 17



37853575
FIX888 Pack of 20
Ø x H: 18 x 22



321813998A
FIX73 Pack of 50
Ø x H: 16 x 20

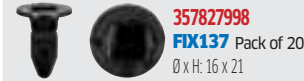

357827998
FIX137 Pack of 20
Ø x H: 16 x 21

Audi • VW • Seat • Škoda



357827998A
FIX139 Pack of 20
Ø x H: 18 x 21



35783718701C
FIX435 Pack of 10
Ø x H: 12,5 x 5,3



357853575
FIX49 Pack of 50
Ø x H: 18 x 22



357867646
FIX413 Pack of 20
W x D x H: 16 x 10,5 x 13



357868143
FIX138 Pack of 50
Ø x H: 16 x 25



3A0853575A
FIX456 Pack of 20
W x D x H: 20 x 20 x 9



3B0838243
FIX83 Pack of 20
Ø x H: 22 x 22



3B0839723
FIX613 Pack of 20
W x D x H: 11 x 5 x 10,5



3B0853576
FIX418 Pack of 20
W x D x H: 25 x 27 x 18



3B0868243
FIX83 Pack of 20
Ø x H: 22 x 22



3C0853586
FIX400 Pack of 20
W x D x H: 18 x 16 x 21



3C0863559
FIX244 Pack of 50
Ø x H: 26,5 x 32



4A0805121A
FIX198 Pack of 20
Ø x H: 25 x 26



4A0805121C
FIX197 Pack of 20
Ø x H: 25 x 27



4A0805960
FIX199 Pack of 10
W x L x R: 25 x 24 x 12



4A0853825
FIX644 Pack of 20
W x D x H: 35 x 22 x 16



4A0853825A
FIX474 Pack of 20
W x D x H: 35 x 22 x 4



4A0853825C
FIX468 Pack of 20
W x D x H: 35 x 27 x 11

Audi • VW • Seat • Škoda



4A0853825C
FIX644 Pack of 20
W x D x H: 35 x 22 x 16



4A0853825D
FIX456 Pack of 20
W x D x H: 20 x 20 x 9



4A0853825E
FIX457 Pack of 10
W x D x H: 23,5 x 20 x 15,5



4D0853825C
FIX478 Pack of 10
W x D x H: 38 x 34 x 15



6K0867838
FIX413 Pack of 20
W x D x H: 16 x 10,5 x 13



6N0807199
FIX716 Pack of 20
Ø x H: 19 x 24



6N0809966A
FIX71 Pack of 50
Ø x H: 12 x 14



6N0868243A
FIX81 Pack of 20
Ø x H: 18 x 26



6Q0853147
FIX614 Pack of 20
W x D x H: 16 x 14 x 20,5



6Q0868243
FIX168 Pack of 20
Ø x H: 23 x 27,5



6U0853733
FIX186 Pack of 20
W x D x H: 31 x 8,5 x 5



6X0867301B
FIX650 Pack of 10
W x D x H: 35 x 21 x 20



701867299
FIX792 Pack of 20
Ø x S: 18 x 12



703867299
FIX274 Pack of 50
Ø x H: 18 x 21



701805163
FIX401 Pack of 20
W x D x H: 17 x 14 x 7



701863841
FIX434 Pack of 20
Ø x H: 24,5 x 18,5



70186729901C
FIX793 Pack of 20
Ø x S: 18 x 12



7018672991YZ
FIX792 Pack of 20
Ø x S: 18 x 12

Audi • VW • Seat • Škoda



701941141A
FIX422 Pack of 10
W x D x H: 30 x 23 x 19,5



703867299
FIX160 Pack of 20
Ø x H: 18 x 21



7603ASCH
FIX186 Pack of 20
W x D x H: 31 x 8,5 x 5



6U0867276C
FIX742 Pack of 20
W x D x H: 11 x 11 x 9 mm



6X0867300A
FIX250 Pack of 50
Ø x H: 20 x 24 mm



7L0839069
FIX494 Pack of 20
W x D x H: 28,5 x 10 x 12,5



7M0867299K
FIX831 Pack of 20
Ø x H: 17 x 20



7M0867299K
FIX167 Pack of 20
Ø x H: 17,5 x 21



80186729901C
FIX46 Pack of 50
Ø x H: 14 x 19



801867299041
FIX46 Pack of 50
Ø x H: 14 x 19



811807447
FIX65 Pack of 50
W x D x H: 10 x 22 x 9

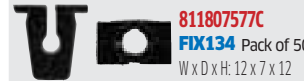

811807577C
FIX1374 Pack of 50
W x D x H: 12 x 7 x 12



811863905A
FIX58 Pack of 50
Ø x H: 19 x 26



82386230301C
FIX30 Pack of 50
Ø x H: 17 x 15



823867299
FIX47 Pack of 50
Ø x H: 18 x 21



8541ASCH
FIX187 Pack of 20
W x D x H: 32 x 10,5 x 6



8541ASCHB
FIX798 Pack of 20
Ø x S: 23 x 16



867809966
FIX71 Pack of 50
Ø x H: 12 x 14

Audi • VW • Seat • Škoda



**Audi • VW
Seat • Škoda**



867863849A01C
FIX325 Pack of 20
W x D x H: 23 x 29 x 15



893867290
FIX80 Pack of 50
Ø x H: 18 x 21



893867290
FIX528 Pack of 50
Ø x H: 18 x 21

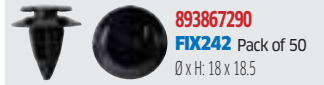

893867290
FIX242 Pack of 50
Ø x H: 18 x 18.5



8D0805121
FIX184 Pack of 50
Ø: 31



8D0805121
FIX195 Pack of 10
Ø x H: 18 x 22



8D0805960
FIX200 Pack of 10
W x L x R: 25 x 24 x 11



8D0853909B
FIX475 Pack of 20
W x D x H: 33.5 x 13 x 6.5



8E0825265C
FIX147 Pack of 50
Ø x H: 16 x 11

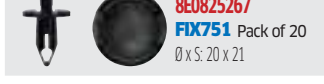

8E0825267
FIX751 Pack of 20
Ø x S: 20 x 21



8E0868243
FIX169 Pack of 20
Ø x H: 27 x 30

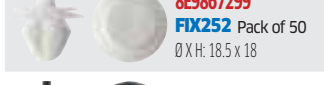

8E9867299
FIX252 Pack of 50
Ø x H: 18.5 x 18



8L0807300
FIX177 Pack of 20
Ø x S: 20 x 24



8N0951257
FIX446 Pack of 10
W x D x H: 30.5 x 24 x 15.5



GR197516319
FIX253 Pack of 50
Ø x H: 20 x 27



HNA53738A
FIX32 Pack of 20
Ø x H: 18 x 30

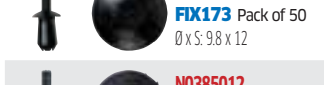

N0385012
FIX173 Pack of 50
Ø x S: 9.8 x 12



N0385012
FIX97 Pack of 50
Ø x S: 10 x 12

**Audi • VW
Seat • Škoda**



N0385012
FIX515 Pack of 50
Ø x S: 10 x 12



N038549101C
FIX100 Pack of 50
Ø x S: 16 x 11



N038549101C
FIX517 Pack of 50
Ø x S: 16 x 13



N038549101C
FIX39 Pack of 50
Ø x S: 16 x 13



N0385494
FIX39 Pack of 50
Ø x S: 16 x 13



N0385494
FIX517 Pack of 50
Ø x S: 16 x 13



N0385501
FIX98 Pack of 20
Ø x S: 12.5 x 12



N10219501
FIX103 Pack of 50
Ø x S: 16 x 11

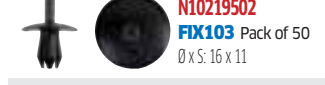

N10219502
FIX103 Pack of 50
Ø x S: 16 x 11

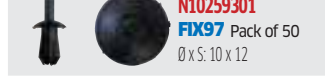

N10259301
FIX97 Pack of 50
Ø x S: 10 x 12



N10259301
FIX515 Pack of 50
Ø x S: 10 x 12

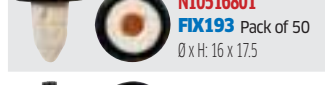

N10516801
FIX193 Pack of 50
Ø x H: 16 x 17.5



N16186729901C
FIX100 Pack of 50
Ø x S: 16 x 11

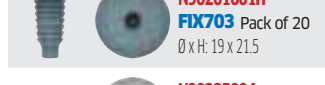

N90201601H
FIX703 Pack of 20
Ø x H: 19 x 21.5



N90335004
FIX184 Pack of 50
Ø: 31

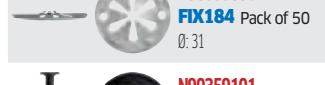

N90335006
FIX184 Pack of 50
Ø: 31

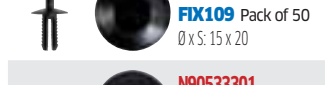

N90359101
FIX109 Pack of 50
Ø x S: 15 x 20



N90533301
FIX631 Pack of 20
Ø x H 20 x 9 mm

**Audi • VW
Seat • Škoda**



N90536901
FIX780 Pack of 20
W x D x S: 12.5 x 10 x 10



N90648702
FIX714 Pack of 20
Ø x H: 15 x 21



N90775001
FIX716 Pack of 20
Ø x H: 19 x 24



N90796501
FIX183 Pack of 50
Ø: 31



N90796501
FIX638 Pack of 5
Ø x H: 14 x 21



N90821401
FIX136 Pack of 50
Ø x H: 15 x 21.5

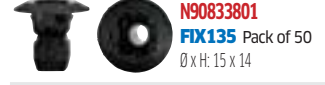

N90833801
FIX135 Pack of 50
Ø x H: 15 x 14

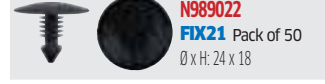

N989022
FIX21 Pack of 50
Ø x H: 24 x 18



W706635SSW
FIX244 Pack of 50
Ø x H: 26.5 x 32



W709167SSZUAM
FIX244 Pack of 50
Ø x H: 26.5 x 32

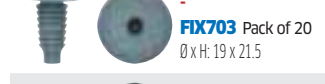

-
FIX703 Pack of 20
Ø x H: 19 x 21.5



-
FIX411 Pack of 20
Ø x H: 16 x 5

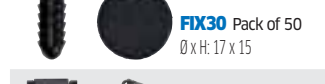

-
FIX30 Pack of 50
Ø x H: 17 x 15



-
FIX722 Pack of 20
W x L x R: 16 x 24 x 12



-
FIX720 Pack of 20
Ø x H: 15.5 x 28

BMW



07131480419
FIX275 Pack of 50
Ø x H: 23 x 26



07147074343
FIX866 Pack of 20
Ø x H: 18 x 32



07147122912
FIX484 Pack of 20
Ø x H: 30 x 33



07147212877
FIX453 Pack of 20
W x L x R: 18.5 x 28 x 10



1916670
FIX100 Pack of 50
Ø x S: 16 x 11



1916670
FIX517 Pack of 50
Ø x S: 16 x 13



1916670
FIX39 Pack of 50
Ø x S: 16 x 13



11121726089
FIX455 Pack of 10
W x D x H: 28 x 32 x 14



11127531561
FIX638 Pack of 5
Ø x H: 14 x 21

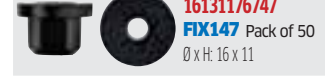

16131176747
FIX147 Pack of 50
Ø x H: 16 x 11



17111712788
FIX447 Pack of 10
Ø x H: 16.5 x 18.5



5113810295
FIX148 Pack of 50
W x D x H: 11 x 21 x 17



52201964201
FIX503 Pack of 50
Ø x H: 18 x 31

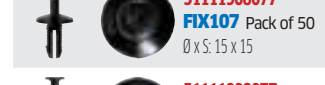

51111908077
FIX107 Pack of 50
Ø x S: 15 x 15

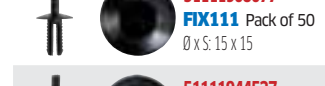

51111908077
FIX111 Pack of 50
Ø x S: 15 x 15

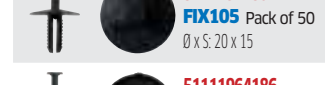

51111944537
FIX105 Pack of 50
Ø x S: 20 x 15

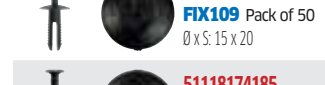

51111964186
FIX109 Pack of 50
Ø x S: 15 x 20



51118174185
FIX112 Pack of 50
Ø x S: 19 x 16





BMW

- 51118174185**
FIX513 Pack of 50
Ø x S: 19 x 14
- 51127046911**
FIX191 Pack of 20
Ø x H: 14.3 x 16
- 51131885399**
FIX124 Pack of 20
W x D x H: 15 x 8 x 15
- 51131924953**
FIX419 Pack of 10
W x D x H: 20 x 8 x 11.5
- 51131946258**
FIX416 Pack of 20
W x D x H: 20 x 13 x 17
- 51137003738**
FIX616 Pack of 10
W x D x H: 43 x 15 x 12
- 51137157702**
FIX617 Pack of 10
W x D x H: 20 x 40 x 8.5
- 51137217789**
FIX618 Pack of 10
W x D x H: 40.5 x 11 x 8.5
- 51138102952**
FIX148 Pack of 50
W x D x H: 11 x 21 x 17
- 51138166675**
FIX417 Pack of 20
W x D x H: 25 x 34 x 16
- 51161881149**
FIX97 Pack of 50
Ø x S: 10 x 12
- 51161881149**
FIX515 Pack of 50
Ø x S: 10 x 12
- 51218205295**
FIX778 Pack of 20
Ø x S: 20 x 18
- 51313401691**
FIX619 Pack of 10
W x D x H: 40 x 14 x 8
- 51317064098**
FIX618 Pack of 10
W x D x H: 40.5 x 11 x 8.5
- 51337052945**
FIX391 Pack of 20
W x D x H: 25 x 14 x 16
- 51338218383**
FIX632 Pack of 20
W x D x H: 38 x 24 x 16.5
- 51338254781**
FIX497 Pack of 10
W x D x H: 41.5 x 23.5 x 16

BMW

- 51411870718**
FIX217 Pack of 50
Ø x H: 18 x 18
- 51411885961**
FIX80 Pack of 50
Ø x H: 18 x 21
- 51411885961**
FIX528 Pack of 50
Ø x H: 18 x 21
- 51411973500**
FIX528 Pack of 50
Ø x H: 18 x 21
- 51417025609**
FIX453 Pack of 20
W x L x R: 18.5 x 28 x 10
- 51418172050**
FIX812 Pack of 20
Ø x H: 18 x 20
- 51418215806**
FIX481 Pack of 20
W x D x H: 17 x 15 x 11
- 51418224768**
FIX272 Pack of 50
Ø x H: 18 x 20
- 51418224768**
FIX528 Pack of 50
Ø x H: 18 x 21
- 51458161557**
FIX482 Pack of 20
W x D x H: 17 x 15 x 15
- 51458266814**
FIX483 Pack of 20
W x D x H: 19 x 17 x 12
- 51471840961**
FIX439 Pack of 20
W x D x H: 15 x 14 x 22
- 51471881521**
FIX219 Pack of 20
Clip/Washer Ø x H: 18.3 x 25
- 51471911992**
FIX114 Pack of 50
Ø x S: 20 x 14
- 51471911992**
FIX506 Pack of 50
Ø x S: 20 x 14
- 51478262533**
FIX404 Pack of 20
Ø x H: 21 x 30.5
- 51513448374**
FIX619 Pack of 10
W x D x H: 40 x 14 x 8
- 51711916197**
FIX383 Pack of 20
Ø x H: 18.5 x 32

BMW

- 51711916199**
FIX878 Pack of 20
Ø x H: 23 x 26
- 51711928946**
FIX415 Pack of 20
W x D x H: 10 x 12 x 17
- 51711945568**
FIX445 Pack of 10
W x D x H: 56 x 18.5 x 22.5
- 51711958025**
FIX146 Pack of 50
Ø x H: 24 x 10.5
- 51711958025**
FIX416 Pack of 20
W x D x H: 20 x 13 x 17
- 51717002953**
FIX213 Pack of 50
Ø x L: 6 x 19. F Ø: 19.7
- 51717006757**
FIX602 Pack of 20
W x D x H: 36 x 14 x 12.5
- 51717066229**
FIX485 Pack of 20
Ø x H: 20 x 36
- 52201964201**
FIX29 Pack of 50
Ø x H: 18 x 28
- 52201964201**
FIX503 Pack of 50
Ø x H: 18 x 31
- 63121387026**
FIX423 Pack of 10
Ø x H: 19 x 28.5
- 63171367868**
FIX890 Pack of 20
W x D x H: 10 x 10 x 15
- 71111179444**
FIX639 Pack of 5
W x D x H: 45.5 x 23 x 32
- 71111179445**
FIX640 Pack of 10
W x D x H: 25 x 25 x 17
- 8262533**
FIX404 Pack of 20
Ø x H: 21 x 30.5
- 82119410191**
FIX219 Pack of 20
Clip/Washer Ø x H: 18.3 x 25
- Sunroof Clip**
FIX791 Pack of 10
W x D x H: 17 x 19 x 10

Chrysler • Jeep • Dodge

- 1595864**
FIX262 Pack of 50
Ø x H: 19 x 18
- 1605396**
FIX262 Pack of 50
Ø x H: 19 x 18
- 10139822**
FIX122 Pack of 50
Ø x S: 18 x 23
- 10139822**
FIX236 Pack of 20
Ø x S: 16 x 18
- 25524005**
FIX210 Pack of 50
Ø x L: 6 x 25. F Ø: 12.9
- 3691590**
FIX500 Pack of 50
Ø x H: 18 x 178
- 6003349**
FIX21 Pack of 50
Ø x H: 24 x 18
- 6004212**
FIX208 Pack of 50
Ø x L: 5 x 15. F Ø: 8.9
- 6030441**
FIX262 Pack of 50
Ø x H: 19 x 18
- 6033082**
FIX29 Pack of 50
Ø x H: 18 x 28
- 6500898**
FIX209 Pack of 50
Ø x L: 5 x 22. F Ø: 11.9
- 6501559**
FIX210 Pack of 50
Ø x L: 6 x 25. F Ø: 12.9
- 6501916**
FIX244 Pack of 50
Ø x H: 26.5 x 32
- 6502871**
FIX121 Pack of 50
Ø x S: 15.5 x 23
- 6503163**
FIX120 Pack of 50
Ø x S: 15 x 19
- 6503598**
FIX751 Pack of 20
Ø x S: 20 x 21
- 6503860**
FIX211 Pack of 50
Ø x L: 6 x 25. F Ø: 16.9
- 6504521**
FIX238 Pack of 20
Ø x S: 18 x 23

Chrysler • Jeep • Dodge

6506007AA
FIX210 Pack of 50
Ø x L: 6 x 25, F Ø: 12,9

6508197AA
FIX122 Pack of 50
Ø x S: 18 x 23

6508197AA
FIX236 Pack of 20
Ø x S: 16 x 18

6508863AA
FIX891 Pack of 20
Ø x S: 18 x 17,5

6682401G00
FIX760 Pack of 20
Ø x S: 13 x 8

MR200300
FIX257 Pack of 50
Ø x S: 18 x 13

-
FIX50 Pack of 50
L: 95

PSA (Citroën • Peugeot)

0137.11
FIX448 Pack of 10
Ø x H: 27 x 11,5

0137.68
FIX448 Pack of 10
Ø x H: 27 x 11,5

2128.22
FIX387 Pack of 20
W x D x H: 19 x 13,5 x 20

6973.A4
FIX712 Pack of 10
Ø x H: 20 x 68

6972.24
FIX42 Pack of 50
Ø x S: 7,6 x 8

6973.24
FIX517 Pack of 50
Ø x S: 16 x 13

6973.24
FIX39 Pack of 50
Ø x S: 16 x 13

PSA (Citroën • Peugeot)

6990.50
FIX250 Pack of 50
Ø x H: 20 x 24 mm

6991.F0
FIX806 Pack of 20
Ø x S: 12 x 14

6991.S6
FIX255 Pack of 50
Ø x H: 18,5 x 18

6991.S6
FIX252 Pack of 50
Ø x H: 18,5 x 18

6991.S6
FIX529 Pack of 50
Ø x H: 18 x 17

6991.W4
FIX888 Pack of 20
Ø x H: 18 x 22

6991.W4
FIX49 Pack of 50
Ø x H: 18 x 22

6992.95
FIX501 Pack of 50
Ø x H: 18 x 19

6992.G2
FIX524 Pack of 50
Ø x H: 9 x 9,5

6995.A3
FIX269 Pack of 50
Ø x H: 17 x 15,5

6996.36
FIX269 Pack of 50
Ø x H: 17 x 15,5

6997.86
FIX349 Pack of 20
W x D x H: 8 x 16,5 x 11

6997.96
FIX867 Pack of 20
W x D x H: 20 x 13 x 17,5

6999.R2
FIX501 Pack of 50
Ø x H: 18 x 19

7030.16
FIX215 Pack of 20
Ø x H: 15,9 x 24

7013.J0
FIX508 Pack of 50
Ø x S: 20 x 11

7427.23
FIX716 Pack of 20
Ø x H: 19 x 24

7518.C0
FIX500 Pack of 50
Ø x H: 18 x 17,8

PSA (Citroën • Peugeot)

7518.N8
FIX164 Pack of 50
Ø x H: 35 x 25

7814.24
FIX98 Pack of 20
Ø x S: 12,5 x 12

7840.L6
FIX353 Pack of 20
W x D x H: 18,5 x 24,5 x 17,5

8211.MV
FIX508 Pack of 50
Ø x S: 20 x 11

8565.35
FIX814 Pack of 20
Ø x H: 18 x 18,5

8565.40
FIX166 Pack of 50
Ø x H: 20 x 16

8565.40
FIX532 Pack of 50
Ø x H: 20 x 16

8565.43
FIX534 Pack of 50
Ø x H: 12 x 10,5

8565.48
FIX266 Pack of 50
Ø x H: 18,5 x 17

8565.48
FIX227 Pack of 50
Ø x H: 20 x 17,5 mm

8565.53
FIX273 Pack of 50
Ø x H: 20 x 20

8565.53
FIX338 Pack of 20
Ø x H: 19 x 17

8964.57
FIX267 Pack of 50
Ø x H: 14 x 17

8964.81
FIX267 Pack of 50
Ø x H: 14 x 17

6715468
FIX184 Pack of 50
Ø: 31

055389000
FIX360 Pack of 20
Ø x H: 22 x 6

77030721
FIX97 Pack of 50
Ø x S: 10 x 12

1609267280
FIX273 Pack of 50
Ø x H: 20 x 20

PSA (Citroën • Peugeot)

7703077111
FIX269 Pack of 50
Ø x H: 17 x 15,5

7903072170
FIX515 Pack of 50
Ø x S: 10 x 12

7903079004
FIX52 Pack of 50
Ø: 8

8E9867299
FIX252 Pack of 50
Ø x H: 18,5 x 18

9608351380
FIX42 Pack of 50
Ø x S: 7,6 x 8

9619769080
FIX349 Pack of 20
W x D x H: 8 x 16,5 x 11

9629547080
FIX6 Pack of 50
Ø x H: 5 x 12

9630090980
FIX806 Pack of 20
Ø x S: 12 x 14

6539ASCHB
FIX166 Pack of 50
Ø x H: 20 x 16

6539ASCHB
FIX532 Pack of 50
Ø x H: 20 x 16

962600842G
FIX690 Pack of 20
Ø x H: 20 x 16

-
FIX363 Pack of 20
Ø x H: 16,5 x 26

-
FIX438 Pack of 20
W x D x H: 22 x 15 x 17

Manufacturers OEM References provided for information and guidance only. E. & O. E.





Fiat • Alfa Romeo
Iveco • Lancia

	1456980 FIX53 Pack of 50 Ø: 11
	4234280 FIX6 Pack of 50 Ø x H: 5 x 12
	4267172 FIX333 Pack of 20 Ø x H: 20 x 14.5
	7560860 FIX333 Pack of 20 Ø x H: 20 x 14.5
	7637466 FIX334 Pack of 20 Ø x H: 24 x 16
	7677865 FIX380 Pack of 20 Ø x H: 14 x 11
	14115980 FIX524 Pack of 50 Ø x H: 9 x 9.5
	14188680 FIX409 Pack of 20 W x L x R: 17 x 12 x 9.5
	14415790 PR10 Pack of 200 Ø x L: 4.8 x 23
	14415890 PR12 Pack of 200 Ø x L: 4.8 x 27
	14569680 FIX52 Pack of 50 Ø: 8
	46410400 FIX824 Pack of 20 Ø x H: 18 x 22
	46461781 FIX446 Pack of 10 W x D x H: 30.5 x 24 x 15.5
	46789809 FIX335 Pack of 20 W x D x H: 13 x 14.5 x 24
	51701542 FIX696 Pack of 20 Ø x H: 18 x 22
	60814822 FIX440 Pack of 20 W x D x H: 9.5 x 17.5 x 13
	71717421 FIX417 Pack of 20 W x D x H: 25 x 34 x 16
	71728806 FIX534 Pack of 50 Ø x H: 12 x 10.5

Fiat • Alfa Romeo
Iveco • Lancia

	BEST VALUE 71737918 FIX532 Pack of 50 Ø x H: 20 x 16
	71741883 FIX258 Pack of 50 Ø x S: 20 x 10
	82382670 FIX440 Pack of 20 W x D x H: 9.5 x 17.5 x 13
	82491303 FIX375 Pack of 20 Ø x H: 18.5 x 22
	142215088 FIX740 Pack of 20 W x D x H: 12 x 12 x 9
	500326189 FIX165 Pack of 20 Ø x H: 18.5 x 21
	500326896 FIX256 Pack of 50 Ø x H: 20 x 17
	BEST VALUE 500326896 FIX533 Pack of 50 Ø x H: 20 x 17
	500358567 FIX824 Pack of 20 Ø x H: 18 x 22
	BEST VALUE 1301019808 FIX505 Pack of 50 Ø x H: 21 x 23
	9408565488 FIX266 Pack of 50 Ø x H: 18.5 x 17
	9408565488 FIX227 Pack of 50 Ø x H 20 x 17.5 mm
	4264257 FIX742 Pack of 20 W x D x H 11 x 11 x 9 mm
	FIX743 Pack of 20 W x D x H: 12 x 12 x 9
	Universal FIX664 Pack of 20 Ø x H: 25 x 26
	Universal FIX668 Pack of 20 Ø x H: 20 x 26
	Universal FIX669 Pack of 20 Ø x H: 22 x 25.5
	Universal FIX699 Pack of 20 Ø x H: 25 x 25

Ford

	1007902 FIX74 Pack of 50 Ø x H: 22 x 21
	1007932 FIX122 Pack of 50 Ø x S: 18 x 23
	1008068 FIX167 Pack of 20 Ø x H: 17.5 x 21
	1008068 FIX831 Pack of 20 Ø x H: 17 x 20
	BEST VALUE 1008086 FIX527 Pack of 50 Ø x H: 17 x 18
	1008086 FIX167 Pack of 20 Ø x H: 17.5 x 21
	1009164 FIX103 Pack of 50 Ø x S: 16 x 11
	1018433 FIX36 Pack of 50 Ø x H: 18 x 17
	1018434 FIX36 Pack of 50 Ø x H: 18 x 17
	1020193 FIX827 Pack of 20 W x D x H: 26.5 x 14 x 18
	1039463 FIX751 Pack of 20 Ø x S: 20 x 21
	1041415 FIX207 Pack of 50 Head Ø: 6. F Ø: 15.8
	1042065 FIX331 Pack of 20 Ø x H: 6 x 13
	1053656300 FIX67 Pack of 50 Ø: 12
	1065204 FIX185 Pack of 20 W x D x H: 15 x 6 x 18
	1070107 FIX48 Pack of 50 Ø x H: 18 x 20
	1416795 FIX23 Pack of 50 W x H: 9.5 x 8
	1480335 FIX390 Pack of 20 Ø x H: 18 x 15

Ford

	1629279 FIX35 Pack of 50 Ø x H: 18 x 17
	1659672 FIX74 Pack of 50 Ø x H: 22 x 21
	1673046 FIX122 Pack of 50 Ø x S: 18 x 23
	1738233 FIX403 Pack of 20 Ø x S: 20 x 7.5
	2T14V35312AB FIX237 Pack of 20 W x D x H: 20 x 15 x 17
	BEST VALUE 332364 FIX500 Pack of 50 Ø x H: 18 x 17.8
	385661 FIX21 Pack of 50 Ø x H: 24 x 18
	389358 FIX50 Pack of 50 L: 95
	BEST VALUE 389358 FIX500 Pack of 50 Ø x H: 18 x 17.8
	3900185 FIX29 Pack of 50 Ø x H: 18 x 28
	BEST VALUE 3900185 FIX503 Pack of 50 Ø x H: 18 x 31
	4855809 FIX891 Pack of 20 Ø x S: 18 x 17.5
	6028434 FIX70 Pack of 50 Ø: 1/8"
	6117693 FIX841 Pack of 20 Ø x H: 18 x 17.5
	6117693 FIX37 Pack of 50 Ø x H: 20 x 19
	6176723 FIX165 Pack of 20 Ø x H: 18.5 x 21
	6448410 FIX245 Pack of 50 Ø x H: 25 x 14
	6482170 FIX69 Pack of 50 Pipes Ø: 4 & 8

 **Ford**

 **6678518**
FIX245 Pack of 50
Ø x H: 25 x 14

 **6715468**
FIX183 Pack of 50
Ø: 31

 **6725950**
FIX35 Pack of 50
Ø x H: 18 x 17

 **7000412**
PR12 Pack of 200
Ø x L: 4.8 x 27

 **7200671**
FIX98 Pack of 20
Ø x S: 12.5 x 12

 **9032112**
FIX810 Pack of 20
Ø x H: 12 x 16

 **96SG16K262**
FIX236 Pack of 20
Ø x S: 16 x 18

 **96SG16K262**
FIX518 Pack of 50
Ø x S: 15 x 21

 **A310A46-AA**
FIX831 Pack of 20
Ø x H: 17 x 20

 **E844052S**
FIX100 Pack of 50
Ø x S: 16 x 11

 **E844052S**
FIX517 Pack of 50
Ø x S: 16 x 13

 **E844052S**
FIX39 Pack of 50
Ø x S: 16 x 13

 **E865220S**
FIX841 Pack of 20
Ø x H: 18 x 17.5

 **E866241SS2M**
FIX756 Pack of 20
Ø x S: 24 x 30

 **F1CZ16674A**
FIX302 Pack of 20
Ø x H: 14 x 12

 **FCP-0180**
FIX384 Pack of 20
W x D x H: 20.5 x 12 x 22

 **MB25556143**
FIX233 Pack of 20
Ø x S: 19 x 11

 **MB-455-56143**
FIX796 Pack of 20
Ø x S: 18 x 13

 **Ford**

 **MB-455-56143**
FIX232 Pack of 20
Ø x S: 18 x 13

 **MB-455-56143**
FIX795 Pack of 20
Ø x S: 18 x 13

 **N8030433**
FIX211 Pack of 50
Ø x L: 6 x 25, F Ø: 16.9

 **N803043-S**
FIX211 Pack of 50
Ø x L: 6 x 25, F Ø: 16.9

 **N803862-S**
FIX210 Pack of 50
Ø x L: 6 x 25, F Ø: 12.9

 **N803946-S**
FIX121 Pack of 50
Ø x S: 15.5 x 23

 **N804675-S**
FIX211 Pack of 50
Ø x L: 6 x 25, F Ø: 16.9

 **N807389-S**
FIX751 Pack of 20
Ø x S: 20 x 21

 **N807994-S**
FIX621 Pack of 20
Ø x H: 12.5 x 10.5

 **V703505-S-301**
FIX184 Pack of 50
Ø: 31

 **W700671**
FIX245 Pack of 50
Ø x H: 25 x 14

 **W700673**
FIX690 Pack of 20
Ø x H: 20 x 16

 **W7029851042065**
FIX331 Pack of 20
Ø x H: 6 x 13

 **W703915SSYB6**
FIX236 Pack of 20
Ø x S: 16 x 18

 **W703915SSYB6**
FIX518 Pack of 50
Ø x S: 15 x 21

 **W704258S**
FIX827 Pack of 20
W x D x H: 26.5 x 14 x 18

 **W704439S**
FIX207 Pack of 50
Head Ø: 6, F Ø: 15.8

 **W706264-S300**
FIX120 Pack of 50
Ø x S: 15 x 19

 **Ford**

 **W709095533**
FIX207 Pack of 50
Head Ø: 6, F Ø: 15.8

 **YC15B03180AB**
FIX330 Pack of 20
Ø x H: 13 x 18

 **-**
FIX32 Pack of 20
Ø x H: 18 x 30

 **-**
FIX355 Pack of 20
Ø x H: 10 x 18

 **-**
FIX356 Pack of 20
Ø x H: 10 x 18

 **-**
FIX733 Pack of 20
Thread: M5 x 20

 **Honda • Acura**

 **90664-671-0030**
FIX449 Pack of 20
W x D x H: 14 x 8 x 11.5

 **93405-0601608**
FIX732 Pack of 20
Thread: M6 x 12

 **15605-6A003**
FIX513 Pack of 50
Ø x S: 19 x 14

 **71592-55D-000**
FIX328 Pack of 10
W x D x H: 23.5 x 19.5 x 34.5

 **71592-56A-000**
FIX328 Pack of 10
W x D x H: 23.5 x 19.5 x 34.5

 **72311-55S-003**
FIX320 Pack of 20
W x D x H: 15 x 9.5 x 15

 **75305-S0A-003**
FIX476 Pack of 20
W x D x H: 18 x 13 x 13

 **75306-SDA-A01**
FIX633 Pack of 20
W x D x H: 27 x 21 x 18

 **90107-S10-003**
FIX605 Pack of 20
Ø x H: 16 x 16

 **90114-SE0-000**
FIX726 Pack of 20
Ø x H: 16 x 24

 **90126-SR4-000**
FIX734 Pack of 20
Ø x H: 16 x 18.5

 **90467-SA6-003**
FIX31 Pack of 50
Ø x S: 15 x 13

 **90467-SA6-003**
FIX522 Pack of 50
Ø x S: 15 x 13

 **90505-SM4-003**
FIX359 Pack of 20
Ø x S: 18 x 22

 **90602-55A-003**
FIX851 Pack of 20
Ø x H: 18 x 21

 **90602-SFA-004**
FIX623 Pack of 20
Ø x H: 16 x 18

 **90602-TA0-003**
FIX861 Pack of 20
Ø x H: 16 x 18

 **90651-S4N-003**
FIX259 Pack of 50
W x D x H: 15 x 9 x 15

Manufacturers OEM References provided for information and guidance only. E. & O. E.



Honda • Acura

-  **90654-SA4-003**
FIX464 Pack of 20
W x D x H: 21 x 8 x 17.5
-  **90657-SB0-003**
FIX487 Pack of 20
Ø x S: 10.5 x 9.5
-  **90664-671-003**
FIX463 Pack of 20
W x D x H: 16 x 7 x 13
-  **90667-S0D-003ZC**
FIX700 Pack of 20
Ø x H: 18 x 22
-  **90667-S0D-003ZH**
FIX877 Pack of 20
Ø x H: 18 x 22
-  **90667-SA7-0030**
FIX261 Pack of 50
Ø x H: 20 x 17
-  **90667-SAO-003**
FIX502 Pack of 50
Ø x H: 18 x 23
-  **90671-S0D-003ZK**
FIX701 Pack of 20
Ø x H: 18 x 15.5
-  **906726718110M**
FIX191 Pack of 20
Ø x H: 14.3 x 16
-  **90672-SJ4-013**
FIX491 Pack of 20
W x D x H: 16 x 16 x 24.5
-  **90675-SB3-003**
FIX181 Pack of 20
Ø x S: 20 x 8
-  **90675-SB3-003**
FIX123 Pack of 50
Ø x S: 20 x 8
-  **90675-SB3-003**
FIX233 Pack of 20
Ø x S: 19 x 11
-  **90687-SAS-0030**
FIX345 Pack of 20
Ø x H: 15 x 18
-  **90687-SB0-013**
FIX807 Pack of 20
Ø x S: 15 x 14
-  **90688-SB0-003**
FIX519 Pack of 50
Ø x S: 18 x 10
-  **90700-SJ4-000**
FIX465 Pack of 20
Ø x H: 30.5 x 12
-  **91501-SG0-003**
FIX871 Pack of 20
W x D x H: 13 x 11.5 x 16

Honda • Acura

-  **91501-SM4-003**
FIX460 Pack of 20
Ø x H: 14 x 17
-  **91501-STK-003**
FIX357 Pack of 20
Ø x H: 30 x 16
-  **91501-SWA-003**
FIX388 Pack of 20
W x D x H: 28.5 x 28.5 x 16.5
-  **91501-SZ3-003**
FIX178 Pack of 20
Ø x S: 19.5 x 13
-  **91501-SZ3-003**
FIX514 Pack of 50
Ø x S: 19.5 x 13
-  **91502-SP0-003**
FIX216 Pack of 20
Ø x S: 20 x 26
-  **91503-S7A-003**
FIX765 Pack of 20
Ø x S: 20 x 11
-  **91503-SP0-003**
FIX182 Pack of 10
Ø x S: 20 x 14
-  **91503-SP0-003**
FIX521 Pack of 50
Ø x S: 20 x 14
-  **91503-SZ3-003**
FIX231 Pack of 20
Ø x S: 19.5 x 13
-  **91503-SZ5-003**
FIX753 Pack of 20
Ø x S: 19.5 x 17
-  **91505-S9A-003**
FIX231 Pack of 20
Ø x S: 19.5 x 13
-  **91508-SR3-003**
FIX785 Pack of 20
Ø x S: 17.5 x 9.5
-  **91510-SR3-003**
FIX486 Pack of 20
W x D x H: 25 x 24 x 11.5
-  **91512SX0003**
FIX180 Pack of 20
Ø x S: 20 x 10
-  **91512-SX0-003**
FIX769 Pack of 20
Ø x S: 20 x 10
-  **91516-SK7-013**
FIX800 Pack of 20
Ø x S: 20 x 15
-  **91534-SE0-000**
FIX489 Pack of 20
W x D x H: 10 x 10.5 x 13

Honda • Acura

-  **91545-SE0-003**
FIX758 Pack of 20
Ø x S: 19.5 x 12
-  **91550-SH3-003**
FIX807 Pack of 20
Ø x S: 15 x 14
-  **91560-S84-A01**
FIX833 Pack of 20
Ø x H: 16.5 x 19
-  **91560-S9A-A01**
FIX846 Pack of 20
Ø x H: 16.5 x 19
-  **91566-SP0-003**
FIX843 Pack of 20
Ø x H: 17.5 x 22.5
-  **91578-SV4-003**
FIX467 Pack of 20
W x D x H: 25.5 x 19 x 10
-  **91591-SJ6-013**
FIX464 Pack of 20
W x D x H: 21 x 8 x 17.5
-  **91606-SE3-030**
FIX707 Pack of 20
Ø x H: 17.5 x 18.5
-  **91620-SR2-003**
FIX191 Pack of 20
Ø x H: 14.3 x 16
-  **91808-SM4-000**
FIX785 Pack of 20
Ø x S: 17.5 x 9.5
-  **91473** Pack of 20
W x D x H: 26 x 19 x 40

Hyundai • Kia

-  **08102-68865**
FIX687 Pack of 20
Ø x H: 18.5 x 16.5
-  **0G032-50037A**
FIX796 Pack of 20
Ø x S: 18 x 13
-  **0G032-50037A**
FIX232 Pack of 20
Ø x S: 18 x 13
-  **0G032-50037A**
FIX795 Pack of 20
Ø x S: 18 x 13
-  **0G032-50037A**
FIX233 Pack of 20
Ø x S: 19 x 11
-  **87756-2E000**
FIX535 Pack of 50
Ø x H: 18 x 14.5
-  **81126-37010**
FIX301 Pack of 20
W x D x H: 26 x 16
-  **82132-22100**
FIX300 Pack of 20
W x D x H: 14 x 6 x 14
-  **82132-27100**
FIX259 Pack of 50
W x D x H: 15 x 9 x 15
-  **86590-28000**
FIX520 Pack of 50
Ø x S: 18 x 13
-  **86590-28000**
FIX232 Pack of 20
Ø x S: 18 x 13
-  **86590-28000**
FIX233 Pack of 20
Ø x S: 19 x 11
-  **92155-22000**
FIX719 Pack of 20
Ø x H: 15 x 24
-  **92351-37000**
FIX645 Pack of 20
Ø x H: 15 x 10
-  **97519-22000**
FIX191 Pack of 20
Ø x H: 14.3 x 16
-  **85325-210005**
FIX795 Pack of 20
Ø x S: 18 x 13
-  **81174-1G000**
FIX458 Pack of 20
W x D x H: 20 x 20 x 29
-  **85325-21000Q5**
FIX872 Pack of 20
Ø x H: 18 x 22

 **Hyundai • Kia**

 **87702-H1000**
FIX821 Pack of 20
W x D x H: 15.5 x 15.3 x 16.7

 **87719-3D000**
FIX868 Pack of 20
Ø x H: 18 x 31

 **87756-2G000**
FIX603 Pack of 20
W x D x H: 22 x 13 x 13

 **87758-3D000**
FIX822 Pack of 20
W x D x H: 20 x 16 x 15

 **87758-3L000**
FIX850 Pack of 20
Ø x H: 18 x 19 x 21

 **-**
FIX720 Pack of 20
Ø x H: 15.5 x 28

 **ISUZU**

 **89422-11500**
FIX801 Pack of 20
W x D x S: 22 x 14 x 9

 **89429-81190**
FIX522 Pack of 50
Ø x S: 15 x 13

 **Land Rover**

 **79086L**
FIX45 Pack of 50
Ø x S: 13 x 13

 **ANR2224**
FIX751 Pack of 20
Ø x S: 20 x 21

 **AWR3994**
FIX523 Pack of 50
Ø x S: 20 x 20

 **DVQ100230**
FIX182 Pack of 10
Ø x S: 20 x 14

 **DVQ100230**
FIX521 Pack of 50
Ø x S: 20 x 14

 **MWC9134**
FIX263 Pack of 50
Ø x H: 14 x 21

 **MWC9134**
FIX886 Pack of 20
Ø x H: 14 x 21

 **Universal**
FIX218 Pack of 50
Ø x H: 18.5 x 31

 **Mazda**

 **01553-00-291**
FIX1 Pack of 50
Ø x H: 14 x 17

 **B092-51-833**
FIX796 Pack of 20
Ø x S: 18 x 13

 **B092-51-833**
FIX232 Pack of 20
Ø x S: 18 x 13

 **B092-51-833**
FIX795 Pack of 20
Ø x S: 18 x 13

 **B092-51-833**
FIX520 Pack of 50
Ø x S: 18 x 13

 **B455-56-741**
FIX302 Pack of 20
Ø x H: 14 x 12

 **BP4K-58-762**
FIX303 Pack of 20
Ø x H: 9.5 x 8

 **E4T6-88-65A**
FIX513 Pack of 50
Ø x S: 19 x 14

 **FB01-56-964**
FIX233 Pack of 20
Ø x S: 19 x 11

 **FB01-56-964**
FIX182 Pack of 10
Ø x S: 20 x 14

 **FB01-56-964**
FIX521 Pack of 50
Ø x S: 20 x 14

 **N304-13-356A**
FIX31 Pack of 50
Ø x S: 15 x 13

 **N304-13-356A**
FIX522 Pack of 50
Ø x S: 15 x 13

 **NA01-56-145**
FIX523 Pack of 50
Ø x S: 20 x 20

 **UB39-56-741**
FIX302 Pack of 20
Ø x H: 14 x 12

 **-**
FIX845 Pack of 20
Ø x H: 18 x 18.5

 **Mercedes-Benz**

 **A0009947345**
FIX653 Pack of 20
W x L x R: 16 x 11 x 8

 **A0019940645**
FIX657 Pack of 10
W x D x H: 16 x 18 x 7

 **A1239940645**
FIX652 Pack of 20
W x L x R: 25 x 11 x 16

 **A2019900536**
FIX724 Pack of 20
Ø x H: 8 x 24

 **A0009871015**
FIX499 Pack of 20
Ø x H: 12 x 17

 **A0009880027**
FIX6 Pack of 50
Ø x H: 5 x 12

 **A0009881625**
FIX890 Pack of 20
W x D x H: 10 x 10 x 15

 **A0009900392**
FIX710 Pack of 20
Ø x S: 10 x 7

 **A0009900392**
FIX43 Pack of 50
Ø x S: 8.7 x 8

 **A0009902292**
FIX710 Pack of 20
Ø x S: 10 x 7

 **A0009902292**
FIX43 Pack of 50
Ø x S: 8.7 x 8

 **A0009902992**
FIX100 Pack of 50
Ø x S: 16 x 11

 **A0009902992**
FIX517 Pack of 50
Ø x S: 16 x 13

 **A0009902992**
FIX39 Pack of 50
Ø x S: 16 x 13

 **A0009903492**
FIX97 Pack of 50
Ø x S: 10 x 12

 **A0009903492**
FIX515 Pack of 50
Ø x S: 10 x 12

 **A0009903492**
FIX710 Pack of 20
Ø x S: 10 x 7

 **A0009903792**
FIX106 Pack of 20
Ø x S: 13 x 15



Manufacturers OEM References provided for information and guidance only. E. & O. E.

 Mercedes-Benz

-   **A0009904092**
FIX117 Pack of 50
Ø x S: 12 x 11
-   **A0009904529**
FIX175 Pack of 50
Ø x S: 16 x 14
-   **A0009904529**
FIX516 Pack of 50
Ø x S: 16.5 x 14
-   **A0009905492**
FIX107 Pack of 50
Ø x S: 15 x 15
-   **A0009905492**
FIX111 Pack of 50
Ø x S: 15 x 15
-   **A0009905592**
FIX103 Pack of 50
Ø x S: 16 x 11
-   **A0009905792**
FIX835 Pack of 20
Ø x H: 16 x 16
-   **A0009908492**
FIX451 Pack of 20
Ø x S: 10 x 11
-   **A0009912771**
FIX848 Pack of 20
Ø x H: 18.5 x 18
-   **A0019880325**
FIX493 Pack of 20
Ø x H: 20 x 13.5
-   **A0019883181**
FIX442 Pack of 10
W x D x H: 18 x 22 x 24
-   **A0019884481**
FIX429 Pack of 20
W x D x H: 15.5 x 12 x 16
-   **A0019884681**
FIX642 Pack of 20
W x D x H: 25 x 19 x 25
-   **A0019884981**
FIX425 Pack of 20
W x D x H: 16 x 16 x 21.5
-   **A0019885081**
FIX430 Pack of 20
W x D x H: 22.5 x 22 x 6
-   **A0019885181**
FIX426 Pack of 20
W x D x H: 23.5 x 12.5 x 15
-   **A0019886081**
FIX432 Pack of 20
W x D x H: 15.5 x 18 x 15.5
-   **A0019886381**
FIX431 Pack of 20
W x D x H: 32 x 19 x 25.5

 Mercedes-Benz

-   **A0019887681**
FIX305 Pack of 20
Ø x H: 11 x 14
-   **A0019888081**
FIX428 Pack of 20
W x D x H: 32.5 x 23 x 23
-   **A0019889642**
FIX609 Pack of 10
Ø x H: 19 x 25
-   **A0019900192**
FIX802 Pack of 10
Ø x S: 30 x 17
-   **A0019901692**
FIX176 Pack of 20
Ø x S: 18.7 x 15
-   **A0019944145**
FIX99 Pack of 50
Ø x S: 18 x 17
-   **A0019976535**
FIX635 Pack of 20
W x D x H: 16 x 16 x 16
-   **A0019979586**
FIX385 Pack of 2
Ø x H: 66 x 60
-   **A0029883781**
FIX310 Pack of 20
W x D x H: 11 x 9 x 15
-   **A0029883881**
FIX312 Pack of 20
W x D x H: 26 x 17.5 x 6
-   **A0029883981**
FIX313 Pack of 20
W x D x H: 11 x 8.5 x 16.5
-   **A0039885078**
FIX140 Pack of 50
Ø x H: 9 x 11
-   **A0039900251**
FIX147 Pack of 50
Ø x H: 16 x 11
-   **A0039944245**
FIX661 Pack of 20
W x L x R: 15.5 x 12 x 6
-   **A0049887678**
FIX480 Pack of 20
Ø x H: 8.5 x 16.5
-   **A0049887778**
FIX479 Pack of 10
W x D x H: 20 x 11 x 7
-   **A0049941545**
FIX660 Pack of 10
W x L x R: 21 x 16 x 9
-   **A0059889778**
FIX472 Pack of 20
W x D x H: 17 x 18 x 20 mm

 Mercedes-Benz

-   **A0069884378**
FIX841 Pack of 20
Ø x H: 18 x 17.5
-   **A0069887278**
FIX858 Pack of 10
W x D x H: 47.5 x 23 x 16
-   **A0069887378**
FIX820 Pack of 20
W x D x H: 19 x 18 x 11.5
-   **A0069887478**
FIX374 Pack of 20
W x D x H: 18 x 8 x 6
-   **A0079887178**
FIX424 Pack of 20
W x D x H: 48 x 33 x 14
-   **0079887678**
FIX478 Pack of 10
W x D x H: 38 x 34 x 15
-   **A0079899978**
FIX853 Pack of 20
Ø x H: 17.5 x 21
-   **A0089973981**
FIX367 Pack of 10
W x D x H: 28 x 12 x 6
-   **A0099884078**
FIX311 Pack of 20
W x D x H: 22 x 14 x 6
-   **A0099884178**
FIX365 Pack of 20
W x D x H: 41 x 21 x 16
-   **A0099884178**
FIX373 Pack of 20
W x D x H: 25 x 12 x 16
-   **A0099884278**
FIX308 Pack of 10
W x D x H: 29 x 20 x 33
-   **A0099884378**
FIX309 Pack of 10
W x D x H: 30 x 23 x 17
-   **A108980027**
FIX346 Pack of 20
Ø x H: 16 x 18
-   **A1239900092**
FIX116 Pack of 50
Ø x S: 12 x 10
-   **A1239900592**
FIX118 Pack of 50
Ø x S: 16 x 12
-   **A1248210520**
FIX600 Pack of 5
Ø x H: 37.5 x 28.5
-   **A1249880492**
FIX427 Pack of 20
W x D x H: 18.5 x 19.5 x 20

 Mercedes-Benz

-   **A1249900492**
FIX759 Pack of 20
Ø x S: 16 x 18
-   **A1249900592**
FIX117 Pack of 50
Ø x S: 12 x 11
-   **A1249900792**
FIX414 Pack of 20
W x D x H: 10.5 x 13.5 x 20.5
-   **A1249900951**
FIX117 Pack of 50
Ø x S: 12 x 11
-   **1269900192**
FIX779 Pack of 20
Ø x S: 20 x 20.5
-   **A1269900392**
FIX804 Pack of 20
Ø x S: 18 x 18.5
-   **A2016980160**
FIX420 Pack of 10
W x D x H: 56.5 x 15 x 12
-   **A2016980660**
FIX634 Pack of 10
W x D x H: 54.5 x 16 x 12
-   **A2016980860**
FIX860 Pack of 10
W x D x H: 56 x 15 x 15
-   **A2019900050**
FIX146 Pack of 50
Ø x H: 24 x 10.5
-   **A2019900292**
FIX114 Pack of 50
Ø x S: 20 x 14
-   **A2019900292**
FIX506 Pack of 50
Ø x S: 20 x 14
-   **A2029970186**
FIX386 Pack of 2
Ø x H: 69 x 47
-   **A2115040059**
FIX601 Pack of 5
W x D x H: 40.5 x 29.5 x 43
-   **A6010782041**
FIX377 Pack of 20
W x D x H: 33 x 12 x 18
-   **A6030780141**
FIX373 Pack of 20
W x D x H: 25 x 12 x 16
-   **A6389840961**
FIX611 Pack of 10
W x D x H: 36 x 20 x 12
-   **A6389940845**
FIX148 Pack of 50
W x D x H: 11 x 21 x 17

 **Mercedes-Benz**

-  **N00000001476**
FIX733 Pack of 20
Thread: M5 x 20
-  **Universal**
FIX98 Pack of 20
Ø x S: 12.5 x 12
-  **Universal**
FIX114 Pack of 50
Ø x S: 20 x 14
-  **-**
FIX641 Pack of 10
W x D x H: 11 x 10 x 17
-  **-**
FIX651 Pack of 20
Ø x S: 27 x 19

 **Mitsubishi**

-  **M283083**
FIX841 Pack of 20
Ø x H: 18 x 17.5
-  **M820141**
FIX114 Pack of 50
Ø x S: 20 x 14
-  **M820141**
FIX506 Pack of 50
Ø x S: 20 x 14
-  **MB083120**
FIX461 Pack of 20
W x D x H: 16 x 12 x 15
-  **MB098145**
FIX747 Pack of 20
Ø x H: 17.5 x 17.5
-  **MB253964**
FIX234 Pack of 20
Ø x S: 17 x 11
-  **MB344728**
FIX794 Pack of 20
Ø x S: 15 x 13
-  **MB476821**
FIX510 Pack of 50
Ø x S: 15 x 9
-  **MB955901**
FIX776 Pack of 20
Ø x S: 11 x 14
-  **MR200300**
FIX257 Pack of 50
Ø x S: 18 x 13
-  **MR200300**
FIX512 Pack of 50
Ø x S: 18 x 13
-  **MR328954**
FIX240 Pack of 50
Ø x S: 20 x 9
-  **MR328954**
FIX507 Pack of 50
Ø x S: 20 x 9
-  **MJ480033**
FIX747 Pack of 20
Ø x H: 17.5 x 17.5
-  **MJ480150**
FIX513 Pack of 50
Ø x S: 19 x 14
-  **MJ481276**
FIX259 Pack of 50
W x D x H: 15 x 9 x 15

 **Nissan • Infiniti Datsun**

-  **01553-00051**
FIX314 Pack of 20
Ø x H: 18 x 18
-  **01553-00172**
FIX345 Pack of 20
Ø x H: 15 x 18
-  **01553-03831**
FIX352 Pack of 20
W x D x H: 16 x 10.5 x 22
-  **01553-04233**
FIX758 Pack of 20
Ø x S: 19.5 x 12
-  **01553-09321**
FIX240 Pack of 50
Ø x S: 20 x 9
-  **01553-09321**
FIX507 Pack of 50
Ø x S: 20 x 9
-  **01553-09611**
FIX766 Pack of 20
Ø x S: 18 x 10
-  **01553-10501**
FIX766 Pack of 20
Ø x S: 18 x 10
-  **10998-30880**
FIX522 Pack of 50
Ø x S: 15 x 13
-  **63876-95596**
FIX233 Pack of 20
Ø x S: 19 x 11
-  **6387695596**
FIX182 Pack of 10
Ø x S: 20 x 14
-  **89427-98070**
FIX261 Pack of 50
Ø x H: 20 x 17
-  **755216-11000**
FIX181 Pack of 20
Ø x S: 20 x 8
-  **755216-11000**
FIX123 Pack of 50
Ø x S: 20 x 8
-  **63878-01E10**
FIX523 Pack of 50
Ø x S: 20 x 20
-  **01515-00QAB**
FIX179 Pack of 20
Ø x S: 17.5 x 11.5
-  **01553-0038U**
FIX795 Pack of 20
Ø x S: 18 x 13
-  **11296-AG000**
FIX768 Pack of 20
Ø x S: 20 x 13

 **Nissan • Infiniti Datsun**

-  **62226-AX000**
FIX371 Pack of 10
W x D x H: 47 x 21 x 25
-  **62227-AX000**
FIX370 Pack of 10
W x D x H: 47 x 21 x 25
-  **62318-01W00**
FIX352 Pack of 20
W x D x H: 16 x 10.5 x 22
-  **63844-01A00**
FIX523 Pack of 50
Ø x S: 20 x 20
-  **63844-D0100**
FIX801 Pack of 20
W x D x S: 22 x 14 x 9
-  **63848-01G00**
FIX758 Pack of 20
Ø x S: 19.5 x 12
-  **63848-01G00**
FIX754 Pack of 20
Ø x S x H: 20 x 8 x 22
-  **63848-35F00**
FIX471 Pack of 20
W x D x H: 32 x 31 x 12
-  **63854-01A00**
FIX523 Pack of 50
Ø x S: 20 x 20
-  **65810-AD20**
FIX794 Pack of 20
Ø x S: 15 x 13
-  **65846-4Z000**
FIX620 Pack of 20
Ø x H: 28 x 10.5
-  **66824-01G00**
FIX760 Pack of 20
Ø x S: 13 x 8
-  **8099905N07**
FIX781 Pack of 20
Ø x S: 18 x 11.5
-  **8522-0M000**
FIX628 Pack of 10
W x D x H: 31 x 30 x 37
-  **91503-S23-003**
FIX768 Pack of 20
Ø x S: 20 x 13
-  **96706B0700**
FIX23 Pack of 50
W x H: 9.5 x 8
-  **N807994-S**
FIX621 Pack of 20
Ø x H: 12.5 x 10.5
-  **-**
FIX606 Pack of 20
Ø x H: 28 x 6

Manufacturers OEM References provided for information and guidance only. E. & O. E.



Renault

-  **82176228**
FIX318 Pack of 20
W x D x H: 14 x 7 x 13.5
-  **703077117**
FIX662 Pack of 20
Ø x H: 20 x 16.5
-  **1609267280**
FIX273 Pack of 50
Ø x H: 20 x 20
-  **7700784059**
FIX883 Pack of 20
W x D x H: 50 x 12.5 x 10.5
-  **7700838242**
FIX883 Pack of 20
W x D x H: 50 x 12.5 x 10.5
-  **7700842510**
FIX396 Pack of 5
W x D x H: 50 x 24 x 30
-  **7701026892**
FIX440 Pack of 20
W x D x H: 9.5 x 17.5 x 13
-  **7701044547**
FIX349 Pack of 20
W x D x H: 8 x 16.5 x 11
-  **7701049008**
FIX729 Pack of 20
Ø x H: 9.5 x 30
-  **7701049270**
FIX166 Pack of 50
Ø x H: 20 x 16
-  **7701049270**
FIX532 Pack of 50
Ø x H: 20 x 16
-  **7701049271**
FIX751 Pack of 20
Ø x S: 20 x 21
-  **7701050734**
FIX816 Pack of 20
Ø x H: 15 x 14
-  **7701057429**
FIX397 Pack of 10
W x D x H: 16.5 x 16.5 x 19
-  **7701070813**
FIX406 Pack of 20
W x D x H: 14 x 8 x 17
-  **7701470779**
FIX533 Pack of 50
Ø x H: 20 x 17
-  **7703017090**
FIX729 Pack of 20
Ø x H: 9.5 x 30
-  **7703044129**
FIX394 Pack of 10
W x D x H: 25 x 17 x 10

Renault

-  **7703046049**
FIX655 Pack of 20
W x L x R: 20 x 16 x 10
-  **7703072116**
FIX97 Pack of 50
Ø x S: 10 x 12
-  **7703072116**
FIX515 Pack of 50
Ø x S: 10 x 12
-  **7703072144**
FIX174 Pack of 50
Ø x S: 10 x 14
-  **7703072172**
FIX173 Pack of 50
Ø x S: 9.8 x 12
-  **7703072173**
FIX43 Pack of 50
Ø x S: 8.7 x 8
-  **7703072173**
FIX95 Pack of 50
Ø x S: 11.4 x 7
-  **7703072224**
FIX42 Pack of 50
Ø x S: 7.6 x 8
-  **7703072261**
FIX806 Pack of 20
Ø x S: 12 x 14
-  **7703072360**
FIX179 Pack of 20
Ø x S: 17.5 x 11.5
-  **7703074022**
FIX346 Pack of 20
Ø x H: 16 x 18
-  **7703077117**
FIX339 Pack of 20
Ø x H: 19 x 15
-  **7703077183**
FIX828 Pack of 20
Ø x H: 15 x 19
-  **7703077225**
FIX164 Pack of 50
Ø x H: 35 x 25
-  **7703077250**
FIX880 Pack of 20
Ø x H: 15 x 20
-  **7703077256**
FIX392 Pack of 20
W x D x H: 19 x 13 x 10
-  **7703077420**
FIX338 Pack of 20
Ø x H: 19 x 17
-  **7703077421**
FIX256 Pack of 50
Ø x H: 20 x 17

Renault

-  **7703077421**
FIX533 Pack of 50
Ø x H: 20 x 17
-  **7703077434**
FIX856 Pack of 20
Ø x H: 15 x 20.5
-  **7703077469**
FIX529 Pack of 50
Ø x H: 18 x 17
-  **7703077469**
FIX255 Pack of 50
Ø x H: 18.5 x 18
-  **7703077476**
FIX495 Pack of 20
Ø x H: 21.5 x 20
-  **77030 77477**
FIX496 Pack of 10
W x D x H: 28 x 16 x 17
-  **7703079070**
FIX52 Pack of 50
Ø: 8
-  **7703079652**
FIX433 Pack of 20
W x D x H: 17 x 10 x 14
-  **7703081056**
FIX604 Pack of 20
W x D x H: 25 x 9 x 16
-  **7703081151**
FIX366 Pack of 20
Ø x H: 8 x 13
-  **7703081180**
FIX646 Pack of 10
W x D x H: 20 x 20 x 29
-  **7703081185**
FIX746 Pack of 20
W x D x H: 15 x 10 x 15.5
-  **7703081185**
FIX867 Pack of 20
W x D x H: 20 x 13 x 17.5
-  **9605204680**
FIX361 Pack of 20
W x D x H: 22 x 14 x 21
-  **8200389607**
FIX854 Pack of 10
Ø x H: 21 x 23
-  **8200389607**
FIX854 Pack of 10
Ø x H: 21 x 23
-  **8200389607**
FIX648 Pack of 20
W x D x H: 45 x 15 x 7

Subaru

-  **909140012**
FIX786 Pack of 20
Ø x S: 16 x 11
-  **59114AG000**
FIX772 Pack of 20
Ø x S: 20 x 12.5
-  **94422-KC030**
FIX707 Pack of 20
Ø x H: 17.5 x 18.5

Suzuki

-  **09409-08310**
FIX845 Pack of 20
Ø x H: 18 x 18.5
-  **90467-11063**
FIX228 Pack of 50
Ø x H: 18 x 17.8
-  **09409-07332-000**
FIX258 Pack of 50
Ø x S: 20 x 10
-  **09409-07308-5PK**
FIX510 Pack of 50
Ø x S: 15 x 9
-  **76243-77K00**
FIX829 Pack of 10
W x D x H: 24 x 23 x 33

Manufacturers OEM References provided for information and guidance only. E. & O. E.

Toyota • Lexus



52161-16010
FIX511 Pack of 50
Ø x S: 18 x 28



52161-20010
FIX764 Pack of 20
Ø x S: 18 x 32



53259-20030
FIX637 Pack of 20
W x D x S: 18 x 18 x 11



53452-90351
FIX491 Pack of 20
W x D x H: 16 x 16 x 24.5



53455-14020
FIX458 Pack of 20
W x D x H: 20 x 20 x 29



53455-14020
FIX382 Pack of 20
W x D x H: 17 x 17 x 25



53789-14010
FIX471 Pack of 20
W x D x H: 32 x 31 x 12



53879-58010
FIX407 Pack of 20
W x D x H: 34.5 x 25 x 18.5



67771-02030
FIX527 Pack of 50
Ø x H: 17 x 18



67771-02030
FIX530 Pack of 50
Ø x H: 18.5 x 20



67771-89104
FIX845 Pack of 20
Ø x H: 18 x 18.5



67867-12150
FIX259 Pack of 50
W x D x H: 15 x 9 x 15



67867-12150
FIX320 Pack of 20
W x D x H: 15 x 9.5 x 15

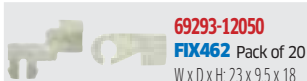

69293-12050
FIX462 Pack of 20
W x D x H: 23 x 9.5 x 18

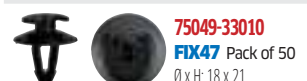

75049-33010
FIX47 Pack of 50
Ø x H: 18 x 21



75395-33030
FIX228 Pack of 50
Ø x H: 18 x 17.8



76931-26010
FIX228 Pack of 50
Ø x H: 18 x 17.8



90044-68320
FIX240 Pack of 50
Ø x S: 20 x 9

Toyota • Lexus



90044-68320
FIX507 Pack of 50
Ø x S: 20 x 9



90189-04008
FIX461 Pack of 20
W x D x H: 16 x 12 x 15



90189-04013
FIX73 Pack of 50
Ø x H: 16 x 20

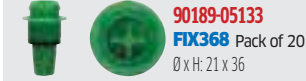

90189-05133
FIX368 Pack of 20
Ø x H: 21 x 36



90189-06001
FIX747 Pack of 20
Ø x H: 17.5 x 17.5



90189-06006
FIX221 Pack of 50
Ø x H: 16.5 x 11



90189-06006
FIX525 Pack of 50
Ø x H: 16 x 11



90189-06013
FIX192 Pack of 50
Ø x H: 20 x 18.5



90189-06013
FIX526 Pack of 50
Ø x H: 20 x 18.5



90189-06018
FIX190 Pack of 50
W x H: 14 x 8



90467-06020-B6
FIX872 Pack of 20
Ø x H: 18 x 22



90189-06224
FIX749 Pack of 20
Ø x H: 16 x 20



90467-06017
FIX522 Pack of 50
Ø x S: 15 x 13



90467-06017
FIX31 Pack of 50
Ø x S: 15 x 13



90467-07041
FIX510 Pack of 50
Ø x S: 15 x 9



90467-07043
FIX781 Pack of 20
Ø x S: 18 x 11.5



90467-07050
FIX345 Pack of 20
Ø x H: 15 x 18



90467-07066
FIX776 Pack of 20
Ø x S: 11 x 14

Toyota • Lexus



90467-07146
FIX774 Pack of 20
Ø x S: 16 x 8



90467-07164
FIX258 Pack of 50
Ø x S: 20 x 10



90467-07201
FIX763 Pack of 20
Ø x S: 20 x 11



90467-07214
FIX771 Pack of 20
Ø x S: 20 x 9



90467-08030
FIX629 Pack of 20
W x D x H: 13 x 7 x 14.5



90467-08081
FIX466 Pack of 20
Ø x H: 30 x 15



90467-08185
FIX766 Pack of 20
Ø x S: 18 x 10



90467-09004/5
FIX459 Pack of 20
Ø x H: 30 x 19.5



90467-09050
FIX301 Pack of 20
W x D x H: 26 x 16



90467-09096
FIX775 Pack of 20
Ø x S: 14.5 x 27



90467-10107
FIX622 Pack of 20
Ø x H: 17 x 14



90467-10161
FIX531 Pack of 50
Ø x H: 18 x 20.5



90467-10167
FIX838 Pack of 20
Ø x H: 18 x 17.5



90467-12042
FIX621 Pack of 20
Ø x H: 12.5 x 10.5



90904-67036
FIX837 Pack of 20
Ø x H: 17 x 24.5



90959-01136
FIX477 Pack of 20
W x D x H: 15.5 x 15.5 x 24

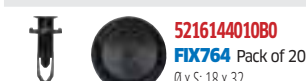

5216144010B0
FIX764 Pack of 20
Ø x S: 18 x 32



5216144010B0
FIX511 Pack of 50
Ø x S: 18 x 28



 Vauxhall • Opel • GM

 Vauxhall • Opel • GM

 Vauxhall • Opel • GM

 Vauxhall • Opel • GM

 **129943**
FIX340 Pack of 20
Ø x H: 13 x 12.5

 **0149907**
FIX863 Pack of 20
Ø x H: 11.5 x 12

 **149910**
FIX810 Pack of 20
Ø x H: 12 x 16

 **157979**
FIX185 Pack of 20
W x D x H: 15 x 6 x 18

 **0164361**
FIX70 Pack of 50
Ø: 1/8"

 **0167935**
FIX710 Pack of 20
Ø x S: 10 x 7

 **0167935**
FIX43 Pack of 50
Ø x S: 8.7 x 8

 **0167935**
FIX95 Pack of 50
Ø x S: 11.4 x 7

 **172017**
FIX417 Pack of 20
W x D x H: 25 x 34 x 16

 **180942**
FIX147 Pack of 50
Ø x H: 16 x 11

 **796255**
FIX819 Pack of 20
Ø x H: 19 x 22.5

 **824767**
FIX317 Pack of 20
W x D x H: 15.5 x 11.5 x 15

 **1104880**
FIX100 Pack of 50
Ø x S: 16 x 11

 **1104880**
FIX517 Pack of 50
Ø x S: 16 x 13

 **1104880**
FIX39 Pack of 50
Ø x S: 16 x 13

 **1104882**
FIX176 Pack of 20
Ø x S: 18.7 x 15

 **1162484**
FIX163 Pack of 50
Ø x H: 28 x 18.5

 **1162488**
FIX170 Pack of 50
W x D x H: 21 x 18 x 10

 **1180216**
FIX343 Pack of 20
W x D x H: 18 x 9.5 x 25

 **1190970**
FIX144 Pack of 20
Ø x H: 23 x 18

 **1216957**
FIX142 Pack of 50
W x H: 11 x 12

 **1218604**
FIX315 Pack of 20
W x D x H: 26 x 23 x 19

 **1222141**
FIX496 Pack of 10
W x D x H: 28 x 16 x 17

 **1400804**
FIX109 Pack of 50
Ø x S: 15 x 20

 **1400806**
FIX110 Pack of 50
Ø x S: 20 x 20

 **1404960**
FIX354 Pack of 20
Ø x H: 20 x 21

 **1406984**
FIX145 Pack of 20
Ø x H: 18 x 25

 **1719242**
FIX173 Pack of 50
Ø x S: 9.8 x 12

 **10036503**
FIX211 Pack of 50
Ø x L: 6 x 25. F Ø: 16.9

 **10053182**
FIX120 Pack of 50
Ø x S: 15 x 19

 **10121502**
FIX29 Pack of 50
Ø x H: 18 x 28

 **10121502**
FIX503 Pack of 50
Ø x H: 18 x 31

 **10184895**
FIX210 Pack of 50
Ø x L: 6 x 25. F Ø: 12.9

 **11067771**
FIX718 Pack of 20
Thread: No. 8 x 1"

 **11589289**
FIX891 Pack of 20
Ø x S: 18 x 17.5

 **14063981**
FIX211 Pack of 50
Ø x L: 6 x 25. F Ø: 16.9

 **2038253**
FIX718 Pack of 20
Thread: No. 8 x 1"

 **2207713**
FIX703 Pack of 20
Ø x H: 19 x 21.5

 **2208843**
FIX342 Pack of 20
Ø x H: 28 x 16

 **2240587**
FIX242 Pack of 50
Ø x H: 18 x 18.5

 **2240593**
FIX242 Pack of 50
Ø x H: 18 x 18.5

 **2317703**
FIX103 Pack of 50
Ø x S: 16 x 11

 **2338955**
FIX267 Pack of 50
Ø x H: 14 x 17

 **2345957**
FIX527 Pack of 50
Ø x H: 17 x 18

 **2345959**
FIX527 Pack of 50
Ø x H: 17 x 18

 **21030249**
FIX751 Pack of 20
Ø x S: 20 x 21

 **22512276**
FIX705 Pack of 20
Ø x H: 21.5 x 24

 **24405740**
FIX496 Pack of 10
W x D x H: 28 x 16 x 17

 **4409693**
FIX256 Pack of 50
Ø x H: 20 x 17

 **4409693**
FIX533 Pack of 50
Ø x H: 20 x 17

 **4412053**
FIX256 Pack of 50
Ø x H: 20 x 17

 **4412053**
FIX533 Pack of 50
Ø x H: 20 x 17

 **6500911**
FIX211 Pack of 50
Ø x L: 6 x 25. F Ø: 16.9

 **88970345**
FIX838 Pack of 20
Ø x H: 18 x 17.5

 **90033713**
FIX70 Pack of 50
Ø: 1/8"

 **90040750**
FIX163 Pack of 50
Ø x H: 28 x 18.5

 **90053803**
FIX144 Pack of 20
Ø x H: 23 x 18

 **90058826**
FIX173 Pack of 50
Ø x S: 9.8 x 12

 **90087290**
FIX100 Pack of 50
Ø x S: 16 x 11

 **90087290**
FIX517 Pack of 50
Ø x S: 16 x 13

 **90087290**
FIX39 Pack of 50
Ø x S: 16 x 13

 **90116376**
FIX103 Pack of 50
Ø x S: 16 x 11

 **90138810**
FIX104 Pack of 50
Ø x S: 16 x 10

 **90218614**
FIX342 Pack of 20
Ø x H: 28 x 16

 **90230960**
FIX142 Pack of 50
W x H: 11 x 12

 **90246867**
FIX343 Pack of 20
W x D x H: 18 x 9.5 x 25

 **90270271**
FIX154 Pack of 50
W x L x H: 16.5 x 11 x 8

 **90321121**
FIX242 Pack of 50
Ø x H: 18 x 18.5

 **90321122**
FIX527 Pack of 50
Ø x H: 17 x 18

 **90355604**
FIX170 Pack of 50
W x D x H: 21 x 18 x 10

 **90356928**
FIX106 Pack of 20
Ø x S: 13 x 15

 **90386374**
FIX315 Pack of 20
W x D x H: 26 x 23 x 19



 **Vauxhall • Opel • GM**



  **90413589**
FIX147 Pack of 50
Ø x H: 16 x 11



  **90414663**
FIX863 Pack of 20
Ø x H: 12 x 13



  **90450482**
FIX176 Pack of 20
Ø x S: 18.7 x 15



  **BEST VALUE**
90457899
FIX527 Pack of 50
Ø x H: 17 x 18



  **90482706**
FIX145 Pack of 20
Ø x H: 18 x 25

  **90508809**
FIX110 Pack of 50
Ø x S: 20 x 20



  **93160023**
FIX256 Pack of 50
Ø x H: 20 x 17



  **BEST VALUE**
93160023
FIX533 Pack of 50
Ø x H: 20 x 17



  **93160780**
FIX856 Pack of 20
Ø x H: 15 x 20.5

  **94198687**
FIX31 Pack of 50
Ø x S: 15 x 13

  **BEST VALUE**
94198687
FIX522 Pack of 50
Ø x S: 15 x 13

  **94530438**
FIX794 Pack of 20
Ø x S: 15 x 13

  **94530623**
FIX182 Pack of 10
Ø x S: 20 x 14

  **BEST VALUE**
94530623
FIX521 Pack of 50
Ø x S: 20 x 14

  **94854203**
FIX749 Pack of 20
Ø x H: 16 x 20

  **BEST VALUE**
94858299
FIX513 Pack of 50
Ø x S: 19 x 14

  **BEST VALUE**
96057846
FIX510 Pack of 50
Ø x S: 15 x 9

  **96057847**
FIX776 Pack of 20
Ø x S: 11 x 14



 **Vauxhall • Opel • GM**

 **204655395**
FIX208 Pack of 50
Ø x L: 5 x 15, F Ø: 8.9

  **BEST VALUE**
909130105
FIX513 Pack of 50
Ø x S: 19 x 14



  **BEST VALUE**
909130115
FIX531 Pack of 50
Ø x H: 18 x 20.5

 **Volvo**



  **947-098**
FIX710 Pack of 20
Ø x S: 10 x 7

  **947098**
FIX95 Pack of 50
Ø x S: 11.4 x 7



 **979878**
FIX206 Pack of 50
Head Ø: 6

  **987789**
FIX781 Pack of 20
Ø x S: 18 x 11.5



  **3120254**
FIX118 Pack of 50
Ø x S: 16 x 12

  **3541113**
FIX758 Pack of 20
Ø x S: 19.5 x 12

  **3541113**
FIX754 Pack of 20
Ø x S x H: 20 x 8 x 22

  **3923475**
FIX103 Pack of 50
Ø x S: 16 x 11

  **12681763**
FIX175 Pack of 50
Ø x S: 16 x 14

  **BEST VALUE**
12681763
FIX516 Pack of 50
Ø x S: 16.5 x 14

  **30808521**
FIX344 Pack of 20
W x D x H: 13.5 x 19.5 x 24

  **30820141**
FIX114 Pack of 50
Ø x S: 20 x 14

 **Volvo**



  **BEST VALUE**
30820141
FIX506 Pack of 50
Ø x S: 20 x 14



  **35126242**
FIX100 Pack of 50
Ø x S: 16 x 11

  **BEST VALUE**
35126242
FIX517 Pack of 50
Ø x S: 16 x 13

  **35126242**
FIX39 Pack of 50
Ø x S: 16 x 13

  **39964090**
FIX762 Pack of 20
Ø x S 15 x 10 mm

  **9133417-7**
FIX709 Pack of 20
Ø x S: 16 x 14

  **3272075327462A**
FIX36 Pack of 50
Ø x H: 18 x 17

  **3272075327462B**
FIX35 Pack of 50
Ø x H: 18 x 17

Universal

  **Universal**
FIX378 Pack of 20
Ø x H: 8 x 11.5 mm

  **Universal**
FIX379 Pack of 20
W x D x H: 8.5 x 8 x 10.5

  **Universal**
FIX675 Pack of 20
Ø x H 15 x 24.5 mm

  **Universal**
FIX688 Pack of 20
Ø x H: 18 x 25

  **Universal**
FIX673 Pack of 20
Ø x H: 18 x 25



  **Universal**
FIX674 Pack of 20
Ø x H: 22 x 24.5

  **Universal**
FIX677 Pack of 20
Ø x H: 18 x 25

  **Universal**
FIX680 Pack of 20
Ø x H: 14.5 x 25

  **Universal**
FIX682 Pack of 20
Ø x H: 18 x 24.5

  **Universal**
FIX684 Pack of 20
Ø x H: 14.5 x 23

  **Universal**
FIX689 Pack of 20
Ø x H: 18 x 23

  **Universal**
FIX20 Pack of 50
Ø x H: 16 x 15

  **Universal**
FIX364 Pack of 20
Ø x H: 22 x 23

Manufacturers OEM References provided for information and guidance only. E. & O. E.





Actual Size Images

Trim Clip Chart

Double sided A1 size guide, folded down to A4 for easy and convenient use.

If displaying range on a wall two copies will be required.

- Contains 330 popular trim clips, body screws, number plate screws and rivets
- New larger format A1 size chart
- Actual size images for quick and easy identification

Part No.	Qty	Description
YCHART1	1	A1 Double Sided Wall Chart





202



203



203



204

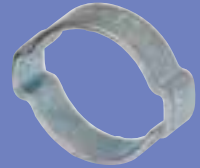

206



207



Tubing + Air



209



210



213

- 202 Hose Clips
- 206 O-Clips
- 207 Hose Connectors
- 208 Hose + Tubing Tools
- 210 Tube Couplings
- 214 Pipe Fittings
- 216 Hose + Tubing
- 219 Air Line Hose
- 220 Air Line Fittings
- 225 Blow Guns
- 226 Air Tools
- 228 Spray Guns
- 229 Tyre Inflators
- 232 Tyre Valve Connectors
- 233 Tyre Pressure Gauges
- 234 Tyre Air Compressors

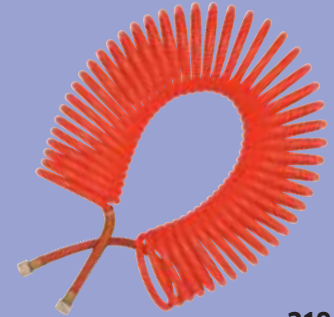

219



220



227



228



231



232



233



235





**BEST
SELLER**

JCS 'Hi-Grip' Hose Clips

Mild steel zinc plated. 12.5 mm (*9.5 mm) band width.
Kite marked to BS 5315 : 1991.

Part No.	Pack of	Size No.	Range	
JCS000	30	12*	9.5 - 12 mm	3/8" - 1/2"
JCSM00	30	16*	11 - 16 mm	1/2" - 5/8"
JCS00	30	20*	13 - 20 mm	1/2" - 3/4"
JCS0	30	22	14 - 22 mm	5/8" - 7/8"
JCS0X	20	25	17 - 25 mm	3/4" - 1"
JCS1A	20	30	22 - 30 mm	7/8" - 1 1/8"
JCS1	20	35	25 - 35 mm	1" - 1 3/8"
JCS1X	20	40	30 - 40 mm	1 1/8" - 1 5/8"
JCS245	20	45	35 - 45 mm	1 3/8" - 1 3/4"
JCS2A	20	50	35 - 50 mm	1 3/8" - 2"
JCS2	20	55	40 - 55 mm	1 5/8" - 2 1/8"
JCS2X	20	60	45 - 60 mm	1 3/4" - 2 3/8"
JCS3	20	70	55 - 70 mm	2 1/8" - 2 3/4"
JCS3X	20	80	60 - 80 mm	2 3/8" - 3 1/8"
JCS4	20	90	70 - 90 mm	2 3/4" - 3 1/2"
JCS4X	20	100	80 - 100 mm	3 1/8" - 4"
JCS5	10	120	90 - 120 mm	3 1/2" - 4 3/4"
JCS6	10	140	110 - 140 mm	4 3/8" - 5 1/2"
JCS7	10	160	130 - 160 mm	5 1/8" - 6 1/4"

Assorted Pack of JCS 'Hi-Grip' Hose Clips - Large Sizes

Mild steel zinc plated. 12.5 mm band width.
Kite marked to BS 5315 : 1991.



Part No.	Pack of
JCS24	24 Pieces

8 x Sizes: 60, 70, 80, 90, 100, 120, 140, 160.



**BEST
SELLER**

Assorted Pack of JCS 'Hi-Grip' Hose Clips - Small Sizes

Mild steel zinc plated. 12.5 mm (9.5 mm) band width.
Kite marked to BS 5315 : 1991.

Part No.	Pack of
JCS50	50 Pieces

8 x Sizes: 12*, 16*, 20*, 22, 25, 30, 35, 40, 50.

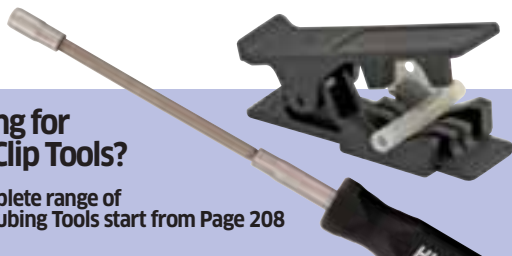

Looking for Hose Clip Tools?

Our complete range of Hose + Tubing Tools start from Page 208



JCS 'Hi-Grip' Hose Clips - Boxed

Mild steel zinc plated.
12.5 mm (*9.5 mm) band width.
Kite marked to BS 5315 : 1991.

Part No.	Box of	Size No.	Range	Range
JCX000	10	12*	9.5 - 12 mm	3/8" - 1/2"
JCXM00	10	16*	11 - 16 mm	1/2" - 5/8"
JCX00	10	20*	13 - 20 mm	1/2" - 3/4"
JCX0	10	22	14 - 22 mm	5/8" - 7/8"
JCX0X	10	25	17 - 25 mm	3/4" - 1"
JCX1A	10	30	20 - 30 mm	7/8" - 1 1/8"
JCX1	10	35	25 - 35 mm	1" - 1 3/8"
JCX1X	10	40	30 - 40 mm	1 1/8" - 1 5/8"
JCX245	10	45	35 - 45 mm	1 3/8" - 1 3/4"
JCX2A	10	50	35 - 50 mm	1 3/8" - 2"
JCX2	10	55	40 - 55 mm	1 5/8" - 2 1/8"
JCX2X	10	60	45 - 60 mm	1 3/4" - 2 3/8"
JCX3	10	70	55 - 70 mm	2 1/8" - 2 3/4"



JCS 'Hi-Grip' Hose Clips Dispenser with 100 Clips

Mild steel zinc plated.
12.5 mm (*9.5 mm) band width.
Kite marked to BS 5315 : 1991.



Part No.	Description
JCS100	100 Piece Set

10 x Sizes: 12*, 16*, 20*, 22, 25, 30, 35, 40, 45, 50.
1 x Flexible hose clip driver: 7 mm Hex.



JCS 'Hi-Grip' Hose Clips Dispenser with 160 Clips

Mild steel zinc plated.
12.5 mm (*9.5 mm) band width.
Kite marked to BS 5315 : 1991.

Part No.	Description
JCS160	160 Piece Set

16 x Sizes: 12*, 16*, 20*, 22, 25, 30, 35, 40, 45, 50, 55, 60, 70, 80, 90, 100.
1 x Flexible hose clip driver: 7 mm Hex.



JCS 'Hi-Grip' 304 Stainless Steel (A2) Hose Clips

Made entirely from 18/8 marine quality stainless steel with Lloyds Register Approval. 12.5 mm (*9.5 mm) band width. Kite marked to BS 5315 : 1991.

• Ideal for salt water and other highly corrosive environments

Part No.	Pack of	Size No.	Range	
JSS000	10	12*	9.5 - 12 mm	3/8" - 1/2"
JSSM00	10	16*	11 - 16 mm	1/2" - 5/8"
JSS00	10	20*	13 - 20 mm	1/2" - 3/4"
JSS0	10	22	14 - 22 mm	5/8" - 7/8"
JSS0X	10	25	17 - 25 mm	3/4" - 1"
JSS1A	10	30	22 - 30 mm	7/8" - 1 1/8"
JSS1	10	35	25 - 35 mm	1" - 1 3/8"
JSS1X	10	40	30 - 40 mm	1 1/8" - 1 5/8"
JSS245	10	45	35 - 45 mm	1 3/8" - 1 3/4"
JSS2A	10	50	35 - 50 mm	1 3/8" - 2"
JSS2	10	55	40 - 55 mm	1 5/8" - 2 1/8"
JSS2X	10	60	45 - 60 mm	1 3/4" - 2 3/8"
JSS3	10	70	55 - 70 mm	2 1/8" - 2 3/4"
JSS3X	5	80	60 - 80 mm	2 3/8" - 3 1/8"
JSS4	5	90	70 - 90 mm	2 3/4" - 3 1/2"
JSS4X	5	100	80 - 100 mm	3 1/8" - 4"
JSS5	5	120	90 - 120 mm	3 1/2" - 4 3/4"
JSS6	5	140	110 - 140 mm	4 3/8" - 5 1/2"
JSS7	5	160	130 - 160 mm	5 1/8" - 6 1/4"



Mini Hose Clips

Part No.	Pack of	Ø Range
HCA8	50	7 - 9 mm
HCA9	50	8 - 10 mm
HCA10	50	9 - 11 mm
HCA11	50	10 - 12 mm
HCA12	50	11 - 13 mm
HCA13	50	12 - 14 mm
HCA14	50	13 - 15 mm
HCA15	50	14 - 16 mm
HCA16	50	15 - 17 mm
HCA17	50	16 - 18 mm

Assorted Box of Mini Hose Clips

Part No.	Box of
AB102	100 Pieces

10 x Sizes (Ø Range): 7 - 9, 8 - 10, 9 - 11, 10 - 12, 11 - 13, 12 - 14, 13 - 15, 14 - 16, 15 - 17, 16 - 18 mm.



JCS Rubber Lined P-Clips

Hole Dia 6 mm. Mild steel, zinc plated. EPDM rubber lined to prevent chafing caused by vibration.

Part No.	Pack of	Size
EAC105	50	5 mm
EAC106	50	6 mm
EAC108	50	8 mm
EAC110	50	10 mm
EAC113	50	13 mm
EAC116	50	16 mm
EAC121	50	21 mm
EAC125	50	25 mm
EAC129	50	29 mm
EAC135	50	35 mm
EAC138	50	38 mm
EAC144	25	44 mm
EAC148	25	48 mm
EAC152	25	52 mm
EAC160	25	60 mm





Assorted Pack of JCS Rubber Lined P-Clips

Hole Dia 6 mm. Mild steel, zinc plated. EPDM rubber lined to prevent chafing caused by vibration.

Part No.	Pack of
EAC100	60 Pieces

5 x Sizes: 6, 21, 29, 35 mm. 10 x Sizes: 8, 10, 13, 16 mm.





CV Boot Metal Clamps

Stainless steel.

Part No.	Pack of	Size	Range
HCV1	20	Small	19 - 40 mm
HCV2	20	Large	50 - 110 mm



CV Boot Clamp Pliers

Part No.	Qty	Description
TL928	1	CV Boot Clamp Pliers





BEST SELLER



JUBILEE Hose Clips

Mild steel zinc plated. 13 mm (*9 mm) band width.
Kite marked to BS 5315 : 1991.

Part No.	Pack of	Size No.	Range
JUB000N	25	000* (12)	9.5 - 12 mm 3/8" - 1/2"
JUBM00N	25	M00* (16)	11 - 16 mm 1/2" - 5/8"
JUB00N	25	00* (20)	13 - 20 mm 1/2" - 3/4"
JUB0N	25	0 (22)	16 - 22 mm 5/8" - 7/8"
JUB0XN	25	0X (25)	18 - 25 mm 3/4" - 1"
JUB1AN	25	1A (30)	22 - 30 mm 7/8" - 1 1/8"
JUB1N	25	1 (35)	25 - 35 mm 1" - 1 3/8"
JUB1XN	25	1X (40)	30 - 40 mm 1 1/8" - 1 5/8"
JUB1MN	25	1M	32 - 45 mm 1 1/4" - 1 3/4"
JUB2AN	25	2A (50)	35 - 50 mm 1 3/8" - 2"
JUB2N	25	2 (55)	40 - 55 mm 1 5/8" - 2 1/8"
JUB2XN	25	2X (60)	45 - 60 mm 1 3/4" - 2 3/8"
JUB3N	25	3 (70)	55 - 70 mm 2 1/8" - 2 3/4"
JUB3XN	10	3X (80)	60 - 80 mm 2 3/8" - 3 1/8"
JUB4N	10	4 (90)	70 - 90 mm 2 3/4" - 3 1/2"
JUB4XN	10	4X (100)	80 - 100 mm 3 1/4" - 4"
JUB5	10	5 (120)	90 - 120 mm 3 3/4" - 4 3/4"
JUB6N	5	6 (140)	110 - 140 mm 4 1/4" - 5 1/2"
JUB7N	5	7	135 - 165 mm 5 1/4" - 6 1/2"

Assorted Pack of JUBILEE Hose Clips - Small Sizes

Mild steel zinc plated. 13 mm (*9 mm) band width.
Kite marked to BS 5315 : 1991.

Part No.	Pack of	Description
JUB50	50 Pieces	Small Sizes

10 x Sizes: 000*, M00*, 00*, 0, 0X, 1A, 1, 1X, 2A, 2.

Assorted Pack of JUBILEE Hose Clips - Large Sizes

Mild steel zinc plated. 13 mm band width.
Kite marked to BS 5315 : 1991.

Part No.	Pack of	Description
JUB25	25 Pieces	Large Sizes

5 x Sizes: 2X, 3, 3X, 4, 4X.

Looking for Hose Clip Tools?

Our complete range of Hose + Tubing Tools start from Page 208

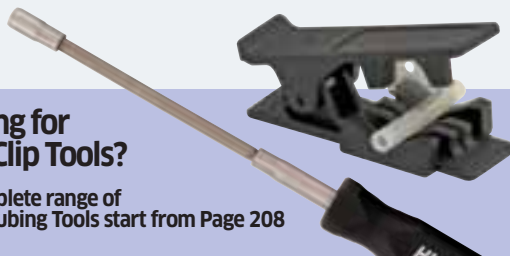

BEST SELLER



JUBILEE Hose Clips In Branded Boxes

Mild steel zinc plated.
Kite marked to BS 5315 : 1991.

Part No.	Box of	Size No.	Range
JUX000	10	000* (12)	9.5 - 12 mm 3/8" - 1/2"
JUXM00	10	M00* (16)	11 - 16 mm 1/2" - 5/8"
JUX00	10	00* (20)	13 - 20 mm 1/2" - 3/4"
JUX0	10	0 (22)	16 - 22 mm 5/8" - 7/8"
JUX0X	10	0X (25)	18 - 25 mm 3/4" - 1"
JUX1A	10	1A (30)	22 - 30 mm 7/8" - 1 1/8"
JUX1	10	1 (35)	25 - 35 mm 1" - 1 3/8"
JUX1X	10	1X (40)	30 - 40 mm 1 1/8" - 1 5/8"
JUX1M	10	1M	32 - 45 mm 1 1/4" - 1 3/4"
JUX2A	10	2A (50)	35 - 50 mm 1 3/8" - 2"
JUX2	10	2 (55)	40 - 55 mm 1 5/8" - 2 1/8"
JUX2X	10	2X (60)	45 - 60 mm 1 3/4" - 2 3/8"
JUX3	10	3 (70)	55 - 70 mm 2 1/8" - 2 3/4"



JUBILEE Hose Clips In Branded Boxes In A Handypack Dispenser

Mild steel zinc plated.
13 mm (*9 mm) band width.
Kite marked to BS 5315 : 1991.

Part No.	Qty	Description
JUX100	1 Set	100 Piece Set

10 x Sizes: 000*, M00*, 00*, 0, 0X, 1A, 1, 1X, 1M, 2A.



JUBILEE Hose Clips Dispenser with 100 Clips and 3 x Hose Clip Drivers

Mild steel zinc plated. 13 mm (*9 mm) band width.
Kite marked to BS 5315 : 1991.

Part No.	Qty	Description
JUB100	1 Set	101 Piece Set

10 x Sizes: 000*, M00*, 00*, 0, 0X, 1A, 1, 1X, 2A, 2, 3 x Flexible hose clip driver: 7 mm Hex.



JUBILEE 'Superclamps' Heavy Duty Bolt Clamps

Zinc plated mild steel. Screws to DIN933.

Part No.	Pack of	Min - Max Ø	Band Width x Thickness	Hex Head
JUBS19	10	17 - 19 mm	18 x 0.6 mm	8 mm
JUBS22	10	20 - 22 mm	18 x 0.6 mm	8 mm
JUBS25	10	23 - 25 mm	18 x 0.6 mm	8 mm
JUBS28	10	26 - 28 mm	18 x 0.6 mm	8 mm
JUBS31	10	29 - 31 mm	18 x 0.6 mm	8 mm
JUBS35	10	32 - 35 mm	18 x 0.6 mm	10 mm
JUBS39	10	36 - 39 mm	18 x 0.6 mm	10 mm
JUBS43	10	40 - 43 mm	18 x 0.6 mm	10 mm
JUBS47	10	44 - 47 mm	20 x 1.0 mm	10 mm
JUBS51	10	48 - 51 mm	20 x 1.0 mm	10 mm
JUBS55	10	52 - 55 mm	20 x 1.0 mm	10 mm
JUBS59	10	56 - 59 mm	20 x 1.0 mm	10 mm
JUBS63	10	60 - 63 mm	20 x 1.0 mm	10 mm
JUBS67	10	64 - 67 mm	20 x 1.0 mm	13 mm
JUBS73	10	68 - 73 mm	25 x 1.5 mm	13 mm
JUBS79	5	74 - 79 mm	25 x 1.5 mm	13 mm
JUBS85	5	80 - 85 mm	25 x 1.5 mm	13 mm
JUBS91	5	86 - 91 mm	25 x 1.5 mm	13 mm
JUBS97	5	92 - 97 mm	25 x 1.5 mm	13 mm
JUBS103	5	98 - 103 mm	25 x 1.5 mm	13 mm
JUBS112	5	104 - 112 mm	25 x 1.5 mm	13 mm
JUBS121	5	113 - 121 mm	25 x 1.5 mm	13 mm
JUBS130	5	122 - 130 mm	25 x 1.5 mm	13 mm
JUBS139	5	131 - 139 mm	25 x 1.5 mm	13 mm
JUBS148	5	140 - 148 mm	25 x 1.8 mm	13 mm
JUBS161	5	149 - 161 mm	25 x 1.8 mm	13 mm
JUBS174	5	162 - 174 mm	25 x 1.8 mm	13 mm
JUBS187	5	175 - 187 mm	25 x 1.8 mm	13 mm



JUBILEE 'Multiband' Mild Steel Banding

Zinc plated. 11 mm band width (steel screws/housings not included).

Part No.	Qty	Length
JUM10	1	10 m Coil
JUM30	1	30 m Coil



JUBILEE 'Multiband' Mild Steel Screws/Housings

Zinc plated. Suits 11 mm 'Multiband'.

Part No.	Pack of	Head Type
JUS1	25	Slotted Head
JUS2	25	Hex Head



BEST
SELLER



TERRY 'Powergrip' Hose Clips

Aluzinc steel band & housing, screw zinc plated steel. 12 mm (~9 mm) band width. Kite marked to BS 5315 : 1991.

Part No.	Pack of	Size No.	Range
HC000	20	12*	9.5 - 12 mm
HCM00	20	16*	11 - 16 mm
HC00	20	20	13 - 20 mm
HCO	20	22	16 - 22 mm
HCOX	20	25	18 - 25 mm
HC1A	20	30	22 - 30 mm
HC1	20	35	25 - 35 mm
HC1X	20	40	30 - 40 mm
HC2A	20	50	35 - 50 mm
HC2	20	55	40 - 55 mm
HC2X	20	60	45 - 60 mm
HC3	20	70	55 - 70 mm
HC3X	20	80	60 - 80 mm
HC4	20	90	70 - 90 mm
HC4X	20	100	85 - 100 mm

TERRY 'Powergrip' Assorted Pack of Hose Clips

Aluzinc steel band & housing, screw zinc plated steel. 12 mm band width. BS 5315.

Part No.	Pack of
AP28	50 Pieces
Sizes HC000 to HC2A	



TERRY 'Powergrip' Hose Clips Dispenser with 100 Clips and Hose Clip Driver

Aluzinc steel band & housing, screw zinc plated steel. 12 mm band width. BS 5315.

Part No.	Qty	Description
HC100	1 Set	102 Piece Set
10 x Sizes: 000*, M00, 00, 0, 0X, 1A, 1, 1X, 2A, 2. 1 x Flexible hose clip driver: 7 mm Hex.		



NORMA

NORMACLAMP® TORRO®
Narrow Band Hose Clips

9 mm band width. Zinc chromate passivated mild steel screw. BS EN 10088-2 Ferritic stainless steel / AISI 430. DIN 3017 (Band and Housing).



Part No.	Pack of	Range
HN0816	20	10 - 16 mm
HN1220	20	12 - 20 mm
HN1625	20	16 - 27 mm
HN2032	20	20 - 32 mm
HN2840	20	28 - 40 mm
HN3250	20	32 - 50 mm
HN4060	20	40 - 60 mm
HN5070	20	50 - 70 mm
HN6080	20	60 - 80 mm
HN7090	20	70 - 90 mm
HN80100	20	80 - 100 mm

Assorted Pack of NORMACLAMP® TORRO®
Narrow Band Hose Clips

9 mm band width. Zinc chromate passivated mild steel screw. BS EN 10088-2 Ferritic stainless steel / AISI 430. DIN 3017 (Band and Housing).



Part No.	Pack of
AP56	50 Pieces

20 x Size Range: 10 - 16 mm. 10 x Size Range: 12 - 20 mm.
5 x Size Range: 16 - 27 mm, 20 - 32 mm, 28 - 40 mm, 32 - 50 mm.



OETIKER

OETIKER Pipe Clips

Zinc plated band. Suitable for small bore petrol pipe, non-reinforced PVC pipe and rubber hose.



Part No.	Pack of	Range
PC1	20	7 - 11 mm
PC3	20	9 - 14 mm
PC2	20	10 - 18 mm



Looking for O-Clip Tools?

Our complete range of Hose + Tubing Tools are overleaf on Page 208



BEST SELLER

O-Clips - 2-Ear Clamps

Zinc plated steel. DIN 1.0338 / SAE 1008/1010.

Part No.	Pack of	I.D.	Range
OC1	25	3/8"	8 - 11 mm
OC1A	50	3/8"	8 - 11 mm
OC2	25	7/16"	9 - 11 mm
OC2A	50	7/16"	9 - 11 mm
OC3	25	1/2"	11 - 13 mm
OC3A	50	1/2"	11 - 13 mm
OC4	25	9/16"	13 - 15 mm
OC4A	50	9/16"	13 - 15 mm
OC5	25	5/8"	15 - 18 mm
OC5A	50	5/8"	15 - 18 mm
OC6	25	3/4"	17 - 20 mm
OC6A	50	3/4"	17 - 20 mm
OC7	25	7/8"	20 - 23 mm
OC7A	50	7/8"	20 - 23 mm

Assorted Box of O-Clips - 2-Ear Clamps

Zinc plated steel. DIN 1.0338 / SAE 1008/1010.

Part No.	Box of
AB38	140 Pieces

6 x Sizes (Ø Range): 3/8" (8 - 11 mm), 7/16" (9 - 11 mm), 1/2" (11 - 13 mm), 9/16" (13 - 15 mm), 5/8" (15 - 18 mm), 3/4" (17 - 20 mm).



OETIKER



OETIKER '167'
O-Clips - Single Ear Clamps

Stainless steel. DIN 1.4301 / UNS S30400.

- 360° stepless design - No steps or gaps in the inner circumference.
- Smooth edged steel prevents damage to hose.



Part No.	Pack of	Range	Width x Thickness
OC11	25	7.0 - 8.7 mm	5 x 0.5 mm
OC12	25	8.3 - 10.0 mm	5 x 0.5 mm
OC13	25	9.6 - 11.3 mm	7 x 0.6 mm
OC14	25	11.3 - 13.8 mm	7 x 0.6 mm
OC15	25	13.2 - 15.7 mm	7 x 0.6 mm
OC16	25	15.3 - 18.5 mm	7 x 0.6 mm
OC17	25	17.8 - 21.0 mm	7 x 0.6 mm
OC18	25	19.4 - 22.6 mm	7 x 0.6 mm

Assorted Box of OETIKER '167'
O-Clips - Single Ear Clamps

Stainless steel. DIN 1.4301 / UNS S30400.

Part No.	Box of
AB144	160 Pieces

8 x Size Ranges: 7.0 - 8.5 mm, 8.5 - 10.0 mm, 9.8 - 11.8 mm, 11.8 - 13.8 mm, 13.2 - 15.8 mm, 15.6 - 17.8 mm, 17.1 - 20.0 mm, 20.2 - 22.8 mm.





Nylon Hose Connectors - Straights

Nylon. Blue. Working temperature 0°C - 100°C.

Part No.	Pack of	For Hose I.D.
PJ105	10	5 mm
PJ106	10	6 mm
PJ108	10	8 mm
PJ110	10	10 mm
PJ112	10	12 mm
PJ116	10	16 mm
PJ119	10	19 mm



Assorted Pack of Nylon Hose Connectors - Straights

Nylon. Blue. Working temperature 0°C - 100°C.

Part No.	Pack of
AP71	35 Pieces

7 x Sizes (Hose I.D.): 5, 6, 8, 10, 12, 16, 19 mm.



Nylon Hose Connectors - Elbows

Nylon. Blue. Working temperature 0°C - 100°C.

Part No.	Pack of	For Hose I.D.
PJ306	5	6 mm
PJ308	5	8 mm
PJ310	5	10 mm
PJ312	5	12 mm
PJ316	5	16 mm
PJ319	5	19 mm



Assorted Pack of Nylon Hose Connectors - Elbows

Nylon. Blue. Working temperature 0°C - 100°C.

Part No.	Pack of
AP72	25 Pieces

5 x Sizes (Hose I.D.): 6, 10, 12, 16, 19 mm.



Nylon Hose Connectors - Reducers

Nylon. Blue. Working temperature 0°C - 100°C.

Part No.	Qty	For Hose I.D.
PJ212	5	12 - 10 mm
PJ216	5	16 - 12 mm
PJ219	5	19 - 16 mm



Hose Connectors - Equal Tees

Nylon. Blue. Working temperature 0°C - 100°C.

Part No.	Pack of	For Hose I.D.
PJ406	5	6 mm
PJ408	5	8 mm
PJ410	5	10 mm
PJ412	5	12 mm
PJ416	5	16 mm
PJ419	5	19 mm



Assorted Pack of Nylon Hose Connectors - Tees

Nylon. Blue. Working temperature 0°C - 100°C.

Part No.	Pack of
AP73	25 Pieces

5 x Sizes (Hose I.D.): 6, 10, 12, 16, 19 mm.

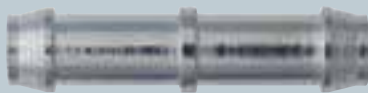

Pipe Joiners

Part No.	Pack of	For Hose I.D.
PJ1	10	3/16"
PJ2	10	1/4"
PJ3	10	5/16"
PJ4	10	3/8"
PJ5	10	1/2"
PJ6	10	5/8"

Assorted Box of Pipe Repair Kit

Part No.	Box of
AB74	72 Pieces

6 x O-Clips: 7/16", 1/2", 9/16", 5/8", 3/4", 7/8".
6 x Pipe Joiners (Hose I.D.): 3/16", 1/4", 5/16", 3/8", 1/2", 5/8".



Brass Straight Hose Connector

Part No.	Qty	Bore Hose
TC1050	2	3/4" (19 mm)
TC1051	2	1" (25 mm)





JCS 'Hi-Grip' Flexible Hose Clip Driver

Flexible shaft.

Part No.	Qty	Hex Size	Shaft Length
TL923	1	7 mm Hex	170 mm



KS TOOLS 'ERGOTORQUE'® Extra Long Flexible Hose Clip Driver

Ergonomic non-slip 2 component handle.

Part No.	Qty	Size	Length
K911.1177	1	7 mm Hex	500 mm

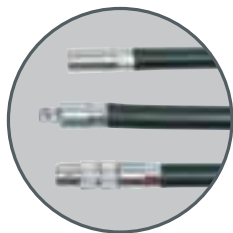

KS TOOLS 'ERGOTORQUE'® Extra Long Flexible Screwdriver Set

Ergonomic non-slip 2 component handle. 500 mm long.

Part No.	Qty	Description
K911.1180	1 Set	16 Piece Set

1 x Hose clip driver, flexible: 7 mm Hex x 500 mm. 1 x Screwdriver, flexible: For 1/4" sockets x 500 mm. 3 x Sockets 1/4": 5, 6, 8 mm. 1 x Screwdriver, flexible: For 1/4" bits x 500 mm. 10 x Bits 1/4", 25 mm: 6 x TORX®: T10, T15, T20, T25, T27, T30. 2 x PHILLIPS®: PH 1, PH 2. 2 x Slotted: 5.5, 6.5 mm.

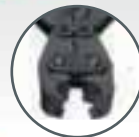

OETIKER O-Clip Hand Installation Pliers with Side Jaw

High quality design compound action pincer with side jaw. Length: 225 mm. Opening Gap: 16.5 mm. Jaw Width: 8 mm

Part No.	Qty	Description
TL9240	1	O-Clip Hand Installation Pliers



O-Clip Crimping Tool

Front closing type.

Part No.	Qty	Description
TL9241	1	O-Clip Crimping Tool



NWS 'Clic' & 'Clic R' Type Hose Clip Pliers

Tool steel, drop-forged and oil-hardened. Spring opening jaws.

Part No.	Qty	Length
TL258	1	175 mm (7")

CV Boot Clamp Pliers

Part No.	Qty	Description
TL928	1	CV Boot Clamp Pliers



KS TOOLS Spring Pipe Clips Hose Clamp Pliers

Bowden cable 650 mm with ratchet locking mechanism.

- For difficult to reach clamps, e.g. cooling system hoses.
- Ratchet locking mechanism to hold the clamps open.

Part No.	Qty	Description
K115.1041	1	Spring Pipe Clip Pliers





Tube Cutter - Heavy Duty

For nylon tubing.

Part No.	Qty	Capacity Ø
TL905	1	3 - 25 mm (1/8" - 1")



Mini Pipe/Tube Cutter

For copper and brass pipe/tubing.

• For use in confined spaces.

Part No.	Qty	Capacity Ø
TL907	1	3 - 16 mm (1/8" - 5/8")



TENG TOOLS Mini Pipe/Tube Cutter

For copper and brass pipe.

Part No.	Qty	Capacity Ø
TTF22	1	3 - 22 mm (1/8" - 7/8")



TENG TOOLS Pipe/Tube Cutter

For copper and brass pipe/tubing.

Heavy duty with spare blade & retractable reamer.

Part No.	Qty	Capacity Ø
TTF30	1	3 - 32 mm (1/8" - 1 1/4")



Hose Clamp

For shutting off petrol, water and brake fluid. Maximum hose diameter: 3/4" (19 mm).

Part No.	Qty	Description
TL909	1	Hose Clamp



Radiator Hose Clamp Pliers

Eliminates the need to drain complete cooling system when servicing any part of the system. Also useful for clamping vacuum lines.

Part No.	Qty	Description
TNH160	1	Hose Clamp Pliers



Tube Cutter

For nylon tubing.

Part No.	Qty	Capacity Ø
TL906	1	Up to 12 mm (1/2")



JG 'Speedfit' Push-Fit Tube Coupling Locking/Release Tools

Suits most types of plastic push-fit tube couplings. Supplied on a holding ring.

Part No.	Qty	Description
TC99	1 Set	5 Piece Set

5 x Sizes: 3/16", 1/4", 5/16", 3/8", 1/2"



Quick-Fit Tube Couplings Locking/Release Spanners

Suits most types of plastic push-fit tube couplings.

Part No.	Qty	Description
TCX99	1 Set	5 Piece Set

5 x Sizes: 3/16" (5 mm), 1/4" (6 mm), 5/16" (8 mm), 3/8" (10 mm), 1/2" (13 mm).



KS TOOLS Fuel Pipe Pliers Set

For opening the compression coupling on fuel pipes. Blue and green pliers for the fuel pipe, where the compression coupling is connected (removing the coupling at the front side). Red pliers with two noses 6.5 x 6 mm for fuel pipes e.g. GM/VAUXHALL (removing the coupling at the side).

Part No.	Qty	Description
K115.1090	1 Set	3 Piece Set

Applications incl.: CHRYSLER, CHEVROLET, CITROËN, FIAT, FORD, PEUGEOT, PONTIAC, RENAULT, VAUXHALL, VW, etc.



JG Speedfit®



BEST SELLER

JG 'Speedfit' Push-Fit Tube Couplings - Straights, Metric

Plastic. Black.

Part No.	Pack of	Size
TC26	10	4 mm
TC27	10	5 mm
TC28	10	6 mm
TC29	10	8 mm
TC30	5	10 mm
TC31	5	12 mm
TC56	5	15 mm

Assorted Box of JG 'Speedfit' Push-Fit Tube Couplings - Straights, Metric

Plastic. Black.

Part No.	Box of
AB97N	22 Pieces

6 x Sizes: 4, 5, 6, 8, 10, 12 mm.



JG Speedfit®



JG 'Speedfit' Push-Fit Tube Couplings - Equal Tees, Metric

Plastic. Black.

Part No.	Pack of	Size
TC50	10	4 mm
TC51	10	5 mm
TC52	10	6 mm
TC53	10	8 mm
TC54	5	10 mm
TC55	5	12 mm

Assorted Box of JG 'Speedfit' Push-Fit Tube Couplings - Elbows & Tees, Metric

Plastic. Black.

Part No.	Box of
AB99	17 Pieces

4 x Tees: 6, 8, 10, 12 mm. 4 x Elbows: 6, 8, 10, 12 mm.



JG Speedfit®

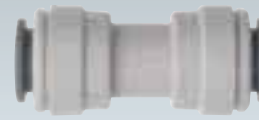

JG 'Speedfit' Push-Fit Tube Couplings - Straights, Imperial

Plastic. Grey.

Part No.	Pack of	Size
TC20	10	5/32"
TC21	10	3/16"
TC22	10	1/4"
TC23	10	5/16"
TC24	5	3/8"
TC25	5	1/2"

JG Speedfit®



JG 'Speedfit' Push-Fit Tube Couplings - Equal Tees, Imperial

Plastic. Grey.

Part No.	Pack of	Size
TC44	10	5/32"
TC45	10	3/16"
TC46	10	1/4"
TC47	10	5/16"
TC48	5	3/8"
TC49	5	1/2"

KS TOOLS
GERMANY



KS TOOLS Fuel Pipe Pliers Set

For opening the compression coupling on fuel pipes. Blue and green pliers for the fuel pipe, where the compression coupling is connected (removing the coupling at the front side). Red pliers with two noses 6.5 x 6 mm for fuel pipes e.g. GM/VAUXHALL (removing the coupling at the side).

Part No.	Qty	Description
K115.1090	1 Set	3 Piece Set

Applications incl.: CHRYSLER, CHEVROLET, CITROËN, FIAT, FORD, PEUGEOT, PONTIAC, RENAULT, VAUXHALL, VW, etc.



JG 'Speedfit' Push-Fit Tube Couplings - Elbows, Metric

Plastic. Black.

Part No.	Pack of	Size
TC40	10	6 mm
TC41	10	8 mm
TC42	5	10 mm
TC43	5	12 mm

Assorted Box of JG 'Speedfit' Push-Fit Tube Couplings - Elbows & Tees, Metric

Plastic. Black.

Part No.	Box of
AB99	17 Pieces

4 x Tees: 6, 8, 10, 12 mm. 4 x Elbows: 6, 8, 10, 12 mm.



JG 'Speedfit' Push-Fit Tube Couplings - Reducing Straights, Metric

Plastic. Black.

Part No.	Pack of	Reducing Size
TC90	5	6 - 4 mm
TC91	5	8 - 6 mm
TC92	5	10 - 8 mm
TC93	5	12 - 10 mm



JG 'Speedfit' Push-Fit Tube Couplings - Reducing Adaptors, Metric

Plastic. Black.

Part No.	Pack of	Reducing Size
TC66	10	6 - 4 mm
TC68	10	8 - 6 mm
TC70	10	10 - 8 mm
TC72	10	12 - 10 mm



JG 'SuperThread' Fitting - Straight Adaptors

Brass. Unique integral seal ensures the thread can be used with BSP, BSPT, NPT, PF and PT fittings.

- No sealant need be applied.
- No danger of tape entering the system.
- Superior flow characteristics.

Part No.	Pack of	Tube O.D.	SuperThread
TC300	10	4 mm	x 1/8" BSP
TC301	10	4 mm	x 1/4" BSP
TC302	10	5 mm	x 1/8" BSP
TC303	10	5 mm	x 1/4" BSP
TC304	10	6 mm	x 1/8" BSP
TC305	10	6 mm	x 1/4" BSP
TC306	10	8 mm	x 1/8" BSP
TC307	10	8 mm	x 1/4" BSP
TC308	10	8 mm	x 3/8" BSP
TC309	10	10 mm	x 1/4" BSP
TC310	10	10 mm	x 3/8" BSP
TC311	10	10 mm	x 1/2" BSP
TC312	10	12 mm	x 3/8" BSP
TC313	10	12 mm	x 1/2" BSP



JG 'Speedfit' Push-Fit Tube Couplings - Plugs

Plastic. Red.

Part No.	Pack of	Stem O.D.
TC74	10	4 mm
TC76	10	6 mm
TC78	10	8 mm
TC80	10	10 mm
TC82	10	12 mm



JG 'Speedfit' Push-Fit Tube Coupling Locking/Release Tools

Suits most types of plastic push-fit tube couplings. Supplied on a holding ring.

Part No.	Qty	Description
TC99	1 Set	5 Piece Set

5 x Sizes: 3/16", 1/4", 5/16", 3/8", 1/2"





Quick-Fit Tube Couplings - Straights, Metric

Plastic, Black.

Part No.	Pack of	Size
TCX26	10	4 mm
TCX27	10	5 mm
TCX28	10	6 mm
TCX29	10	8 mm
TCX30	5	10 mm
TCX31	5	12 mm
TCX56	5	15 mm

Assorted Box of Quick-Fit Couplings - Straights, Metric

Plastic, Black.

Part No.	Box of
AB187	24 Pieces

6 x Sizes: 4, 5, 6, 8, 10, 12 mm.



Quick-Fit Tube Couplings - Straights, Imperial

Plastic, Grey.

Part No.	Pack of	Size
TCX20	10	5/32"
TCX21	10	3/16"
TCX22	10	1/4"
TCX23	10	5/16"
TCX24	5	3/8"
TCX25	5	1/2"



Quick-Fit Tube Couplings - Two Way Dividers, Metric

Plastic, Black.

Part No.	Pack of	Size
TCX114	5	4 mm
TCX116	5	6 mm
TCX118	5	8 mm
TCX120	5	10 mm
TCX122	5	12 mm



Quick-Fit Tube Couplings - Equal Tees, Metric

Plastic, Black.

Part No.	Pack of	Size
TCX50	10	4 mm
TCX51	10	5 mm
TCX52	10	6 mm
TCX53	10	8 mm
TCX54	5	10 mm
TCX55	5	12 mm



Quick-Fit Tube Couplings - Elbows, Metric

Plastic, Black.

Part No.	Pack of	Size
TCX104	10	4 mm
TCX105	10	5 mm
TCX40	10	6 mm
TCX41	10	8 mm
TCX42	5	10 mm
TCX43	5	12 mm

Assorted Box of Quick-Fit Couplings - Elbows + Tees, Metric

Plastic, Black.

Part No.	Box of
AB188	17 Pieces

4 x Tees: 6, 8, 10, 12 mm. 4 x Elbows: 6, 8, 10, 12 mm.



Quick-Fit Tube Couplings Locking/Release Spanners

Suits most types of plastic push-fit tube couplings.

Part No.	Qty	Description
TCX99	1 Set	5 Piece Set

5 x Sizes: 3/16" (5 mm), 1/4" (6 mm), 5/16" (8 mm), 3/8" (10 mm), 1/2" (13 mm).



NORGREN 'Fleetfit' Brass Push-In Fittings with Tube Supports

Meets DOT FMVSS 106, SAE J1131, DIN 74324 and TÜV requirements.

Part No.	Pack of	Size
TC206	5	6 mm
TC208	5	8 mm
TC209	3	9 mm
TC210	3	10 mm
TC211	3	11 mm
TC212	3	12 mm



Brass Push-Fit Tube Couplings - Equal Tee, Metric

Part No.	Pack of	Size
TC124	3	4 mm
TC125	3	5 mm
TC126	3	6 mm
TC128	3	8 mm
TC130	1	10 mm
TC132	1	12 mm



Brass Push-Fit Tube Couplings - Straight, Metric

Part No.	Pack of	Size
TC104	5	4 mm
TC105	5	5 mm
TC106	5	6 mm
TC108	5	8 mm
TC110	3	10 mm
TC112	3	12 mm

Assorted Box of Brass Push-Fit Couplings - Straights, Metric

Part No.	Box of
AB189	18 Pieces

6 x Sizes: 4, 5, 6, 8, 10, 12 mm.

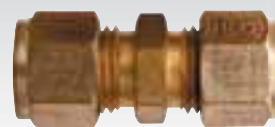

**BEST
SELLER**

Brass Tube Couplings - Imperial

Complete with stepped olives. NOT suitable for diesel.

Part No.	Pack of	Size
TC1	10 Sets	1/8"
TC2	10 Sets	5/32"
TC3	10 Sets	3/16"
TC4	10 Sets	1/4"
TC5	10 Sets	5/16"
TC6	10 Sets	3/8"
TC7	10 Sets	1/2"
TC8	10 Sets	5/8"

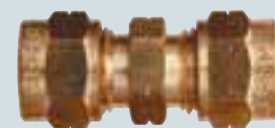

Brass Tube Couplings - Metric

Complete with stepped olives. NOT suitable for diesel.

Part No.	Pack of	Size
TC9	10 Sets	4 mm
TC10	10 Sets	5 mm
TC11	10 Sets	6 mm
TC12	10 Sets	8 mm
TC15	10 Sets	9 mm
TC13	10 Sets	10 mm
TC16	10 Sets	11 mm
TC14	10 Sets	12 mm
TC17	10 Sets	13 mm
TC19	10 Sets	14 mm

Assorted Box of Tube Couplings Brass - Metric

Part No.	Box of
AB95N	27 Pieces

6 x Sizes: 4, 5, 6, 8, 10, 12 mm.



Assorted Box of Olives Stepped - Metric

Part No.	Box of
AB111N	185 Pieces

6 x Sizes: 4, 5, 6, 8, 10, 12 mm.



Assorted Box of Olives Stepped & Barrel - Imperial

Part No.	Box of
AB64N	450 Pieces

7 x Stepped: 1/8", 5/32", 3/16", 1/4", 5/16", 3/8", 1/2".
7 x Barrel: 1/8", 5/32", 3/16", 1/4", 5/16", 3/8", 1/2".



Malleable Iron Pipe Fitting - Female Equal Elbow 90° (90)

BS EN 10242. Class B. Black finish

Part No.	Qty	BSPP Thread Size
TC544	5	1/4"
TC545	5	3/8"
TC546	5	1/2"
TC540	2	3/4"
TC541	2	1"
TC542	1	1 1/4"
TC547	1	1 1/2"
TC543	1	2"



Malleable Iron Pipe Fitting - Equal Hex Nipple (280)

BS EN 10242. Class B. Black finish

Part No.	Qty	BSPT Thread Size
TC514	5	1/4"
TC515	5	3/8"
TC516	5	1/2"
TC510	5	3/4"
TC511	2	1"
TC517	2	1 1/4"
TC512	1	1 1/2"
TC513	1	2"



Malleable Iron Pipe Fitting - Female Equal Tee 90° (130)

BS EN 10242. Class B. Black finish

Part No.	Qty	BSPP Thread Size
TC564	2	3/8"
TC565	2	1/2"
TC560	2	3/4"
TC561	2	1"
TC563	1	1 1/2"
TC562	1	2"



Malleable Iron Pipe Fitting - Reducing Hex Nipple (245)

BS EN 10242. Class B. Black finish

Part No.	Qty	BSPT Thread Size
TC577	5	3/8" : 1/4"
TC580	5	1/2" : 1/4"
TC578	5	1/2" : 3/8"
TC581	2	1/2" : 1"
TC582	2	1/2" : 1 1/4"
TC584	2	1/2" : 1 1/2"
TC579	2	3/4" : 3/8"
TC572	2	3/4" : 1/2"
TC585	2	3/4" : 1 1/2"
TC574	2	1" : 3/4"
TC583	1	1" : 1 1/4"
TC575	1	1 1/4" : 3/4"
TC570	1	1 1/2" : 1"
TC576	1	1 1/2" : 1 1/4"
TC586	1	2" : 3/4"
TC573	1	2" : 1"
TC587	1	2" : 1 1/4"
TC571	1	2" : 1 1/2"



Malleable Iron Pipe Fitting - Reducing Hex Bush (241)

BS EN 10242. Class B. Black finish

Part No.	Qty	BSPT : BSPP Thread Size	Type
TC525	5	3/8" : 1/4"	M : F
TC526	5	1/2" : 3/8"	M : F
TC522	5	3/4" : 1/2"	M : F
TC524	2	1" : 3/4"	M : F
TC520	2	1 1/2" : 1"	M : F
TC523	1	2" : 1"	M : F
TC521	1	2" : 1 1/2"	M : F



Malleable Iron Pipe Fitting - Square Hollow Plug (290)

BS EN 10242. Class B. Black finish

Part No.	Qty	BSPT Thread Size
TC556	5	1/8"
TC558	5	1/4"
TC557	5	3/8"
TC550	5	1/2"
TC551	5	3/4"
TC552	5	1"
TC553	2	1 1/4"
TC554	2	1 1/2"
TC555	1	2"



Malleable Iron Pipe Fitting - Barrel Nipple

BS EN 10241. Class B. Black finish.

Part No.	Qty	BSPT Thread Size	Length
TC604	5	1/4"	40 mm
TC605	5	3/8"	40 mm
TC606	5	1/2"	50 mm
TC600	5	3/4"	55 mm
TC601	2	1"	60 mm
TC607	2	1 1/4"	70 mm
TC602	1	1 1/2"	70 mm
TC603	1	2"	100 mm



Malleable Iron Pipe Fitting - Female Socket (270)

BS EN 10242, Class B, Black finish

Part No. Qty BSPP Thread Size

TC504	5	1/8"
TC503	5	1/4"
TC505	5	3/8"
TC506	5	1/2"
TC500	5	3/4"
TC501	2	1"
TC507	1	1 1/4"
TC508	1	1 1/2"
TC502	1	2"



Brass Claw Fittings - Male

Fully compatible with standard quick connect water couplings.

Part No. Qty Size

TC1028	2	3/8" BSP
TC1029	2	1/2" BSP
TC1030	2	3/4" BSP
TC1031	2	1" BSP



Brass Claw Fittings - Female

Fully compatible with standard quick connect water couplings.

Part No. Qty Size

TC1024	2	3/8" BSP
TC1025	2	1/2" BSP
TC1026	2	3/4" BSP
TC1027	2	1" BSP



Brass Claw Fittings - Rubber Moulded Gasket

Fully compatible with standard quick connect water couplings.

Part No. Qty Description

TC1040	10	Moulded Gasket
---------------	----	----------------



Compressor Air Hose Assembly

20 bar/300 PSI high quality rubber hose. Complete with brass claw fitting safety couplings.

Part No.	Qty	Size	Length
AL500	1 Coil	3/4"	15 m



Brass Claw Fittings - Tap Cap & Tail

Fully compatible with standard quick connect water couplings.

Part No. Qty Thread Size Bore Hose

TC1001	2	1/2" BSP	1/2"
TC1002	2	3/4" BSP	1/2"
TC1003	2	3/4" BSP	3/4"
TC1004	2	1" BSP	1/2"
TC1005	2	1" BSP	3/4"
TC1006	2	1" BSP	1"
TC1007	2	1 1/4" BSP	1"
TC1008	2	1 1/4" BSP	1 1/4"



Brass Quick Connector - Hose Tail

Fully compatible with standard quick connect water couplings.

Part No. Qty Bore Hose

TC1020	2	3/8" (10 mm)
TC1021	2	1/2" (13 mm)
TC1022	2	3/4" (19 mm)
TC1023	2	1" (25 mm)



Brass Quick Connector - Hex Male

Part No. Qty Thread Size Bore Hose

TC1012	2	3/4" BSP	3/4" (19 mm)
TC1010	1	3/4" BSP	1" (25 mm)
TC1011	1	1" BSP	1" (25 mm)



Brass Straight Hose Connector

Part No. Qty Bore Hose

TC1050	2	3/4" (19 mm)
TC1051	2	1" (25 mm)



Whip Check Cables

Steel cable and plated springs.

Part No.	Qty	Cable Diameter	Suits Hose Diameter	Length
AL90	1	1/8"	1/2" to 1 1/4" (Small)	540 mm
AL91	1	1/4"	1 1/2" to 3" (Large)	970 mm

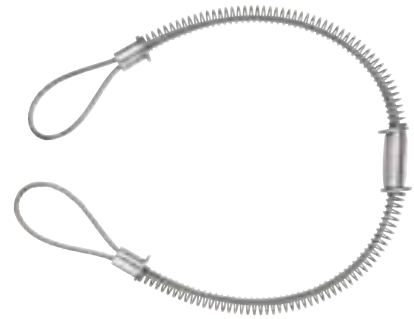



Silicone Hose

Blue silicone VMQ with 3 ply polyester net.
Temperature Range: -60°C to +180°C.
Suitable for cooling and heating systems. 4.5 mm thick.
Working pressure: 8.33 Bar. Burst pressure: 25 Bar.

Part No.	Length	O.D. x I.D.
TUS6	1 m	15.5 x 6.5 mm (9/16" x 1/4")
TUS9	1 m	18.5 x 9.5 mm (11/16" x 3/8")
TUS13	1 m	22 x 13 mm (7/8" x 1/2")
TUS16	1 m	25 x 16 mm (1" x 5/8")
TUS19	1 m	28 x 19 mm (1 7/64" x 3/4")
TUS22	1 m	31 x 22 mm (1 1/4" x 7/8")
TUS25	1 m	34 x 25 mm (1 5/16" x 1")
TUS28	1 m	37 x 28 mm (1 7/16" x 1 1/8")
TUS32	1 m	41 x 32 mm (1 10/16" x 1 1/4")
TUS35	1 m	44 x 35 mm (1 12/16" x 1 3/8")
TUS38	1 m	47 x 38 mm (1 14/16" x 1 1/2")
TUS41	1 m	49 x 40 mm (1 15/16" x 1 5/8")
TUS45	1 m	54 x 45 mm (2 1/8" x 1 3/4")
TUS48	1 m	57 x 48 mm (2 1/4" x 1 7/8")
TUS51	1 m	62 x 51 mm (2 7/16" x 2")
TUS57	1 m	68 x 57 mm (2 11/16" x 2 1/4")
TUS60	1 m	71 x 60 mm (2 25/32" x 2 3/8")



Silicone Hose - 90° Elbows with 150 mm Legs

Blue silicone VMQ with 3 ply polyester net. Temperature Range: -60°C to +180°C.
Suitable for cooling and heating systems. 4.5 mm thick.
Working pressure: 8.33 Bar. Burst pressure: 25 Bar.

Part No.	Qty	O.D. x I.D.
TUS906	1	15.5 x 6.5 mm (9/16" x 1/4")
TUS909	1	18.5 x 9.5 mm (11/16" x 3/8")
TUS9013	1	22 x 13 mm (7/8" x 1/2")
TUS9016	1	25 x 16 mm (1" x 5/8")
TUS9019	1	28 x 19 mm (1 7/64" x 3/4")
TUS9022	1	31 x 22 mm (1 1/4" x 7/8")
TUS9025	1	34 x 25 mm (1 5/16" x 1")
TUS9028	1	37 x 28 mm (1 7/16" x 1 1/8")
TUS9032	1	41 x 32 mm (1 10/16" x 1 1/4")
TUS9035	1	44 x 35 mm (1 12/16" x 1 3/8")
TUS9038	1	47 x 38 mm (1 14/16" x 1 1/2")
TUS9041	1	49 x 40 mm (1 15/16" x 1 5/8")
TUS9045	1	54 x 45 mm (2 1/8" x 1 3/4")
TUS9048	1	57 x 48 mm (2 1/4" x 1 7/8")
TUS9051	1	62 x 51 mm (2 7/16" x 2")
TUS9057	1	68 x 57 mm (2 11/16" x 2 1/4")
TUS9060	1	71 x 60 mm (2 25/32" x 2 3/8")

NORMAL AND LEAD FREE



Fuel Injection Hose

15 Bar working pressure. Environmental temp: -20° to +150°C. SAE J30 R9.
Compatible with E10 fuel.

For unleaded, leaded and diesel fuels.

- Suitable for higher temperatures found in fuel injection systems

Part No.	Length	O.D. x I.D.
TUB81	5 m Coil	12.6 x 5.6 mm
TUB82	5 m Coil	14.6 x 7.6 mm
TUB83	5 m Coil	16.5 x 9.5 mm

BSAU 108 & SAE 30 R6



BEST SELLER

Fuel Hose

20 bar working pressure. Environmental temp: -20° to +80°C.
BS AU 108/2/L4/C4/R SAE 30 R6. Compatible with E10 fuel.

For unleaded and leaded fuels found in normal carburettor systems and diesel.

- Also for power steering low pressure side return

Part No.	Length	O.D. x I.D.
TUB45	5 m Coil	12 x 5 mm (3/16")
TUB46	5 m Coil	13 x 6 mm (1/4")
TUB47	5 m Coil	15 x 8 mm (5/16")
TUB48	5 m Coil	17 x 10 mm (3/8")



BEST SELLER

Fuel Hose - Textile Overbraided

Environmental temp: -20 to +70°C. Compatible with E10 fuel.
Suitable for leaded, unleaded and diesel fuels.

- Commonly used on diesel injection, fuel leak off or coolant applications

Part No.	Length	O.D. x I.D.	Working Pressure
TUB69	5 m Coil	7.0 x 3.2 mm	12.5 bar
TUB70	5 m Coil	7.5 x 3.5 mm	12.5 bar
TUB71	5 m Coil	10.0 x 5.0 mm	10 bar
TUB72	5 m Coil	11.0 x 6.0 mm	10 bar
TUB73	5 m Coil	13.0 x 8.0 mm	8 bar
TUB74	5 m Coil	15.0 x 10.0 mm	5 bar
TUB75	5 m Coil	18.0 x 12.0 mm	5 bar

CAR HEATER HOSE SAE J20 R3



Heater Hose

Resistant to hot water, anti-freeze and coolant 6 bar working pressure. SAE J 20 R3.
Working temperature: -40°C to +120°C. NOT suitable for oil.

Part No.	Length	O.D. x I.D.
HH4	20 m Coil	17.0 x 10.0 mm (3/8")
HH1	20 m Coil	19.5 x 12.7 mm (1/2")
HH2	20 m Coil	23.0 x 15.9 mm (5/8")
HH3	20 m Coil	26.5 x 19.1 mm (3/4")



Diesel Leak Off Bungs

Part No.	Pack of	Description
TUB99	10	Diesel Leak Off Bungs

CAR HEATER HOSE SAE J20 R3



Air Brake Hose

15 bar working pressure.
SAE J 1402.

Part No.	Length	O.D. x I.D.
BR10	4 m Coil	19 x 10 mm 3/8"



Advance/Retard Tubing - Black Nylon

BS 5409:2

Part No.	Length	O.D. x I.D.
TUB21	30 m Coil	1/8" x 0.075"



Advance/Retard Tubing - Soft Flexible Chloroprene Rubber

Can be used for windscreen washer. NOT suitable for diesel.

Part No.	Length	O.D. x I.D.
TUB42	10 m Coil	9 x 3 mm
TUB44	10 m Coil	10 x 4 mm



Nylon Tubing Flexible - Black Metric

DIN 73378 & DIN 74324 and BS 5409 Pt. 1.
Oil, petrol and diesel safe. Suitable for air.

Part No.	Length	O.D. x I.D.
TUB104	30 m Coil	4.0 x 2.5 mm
TUB105	30 m Coil	5.0 x 3.3 mm
TUB106	30 m Coil	6.0 x 4.0 mm
TUB109	30 m Coil	8.0 x 6.0 mm
TUB110	30 m Coil	10.0 x 7.5 mm
TUB111	30 m Coil	10.0 x 7.0 mm
TUB112	30 m Coil	12.0 x 9.0 mm
TUB103	30 m Coil	3/16" x .117"

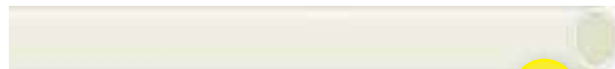

Nylon Tubing Flexible - Natural Metric

DIN 73378 & DIN 74324 and BS 5409 Pt. 1.
Oil, petrol and diesel safe. Suitable for air.

Part No.	Length	O.D. x I.D.
TUB50	30 m Coil	4.0 x 2.50 mm
TUB51	30 m Coil	6.0 x 4.00 mm
TUB52	30 m Coil	8.0 x 6.00 mm
TUB53	30 m Coil	10.0 x 7.50 mm
TUB56	30 m Coil	12.0 x 9.00 mm
TUB54	30 m Coil	12.0 x 10.00 mm

**BEST
SELLER**

PVC Tubing - Clear Plain Windscreen Washer Type

Part No.	Length	O.D. x I.D.
TUB11	30 m Coil	6 x 3 mm (1/8")
TUB12	30 m Coil	8 x 5 mm (3/16")
TUB13	30 m Coil	9 x 6 mm (1/4")
TUB14	30 m Coil	11 x 8 mm (5/16")



PVC Tubing - Clear Re-inforced (Braided) Terylene

250 PSI. NOT suitable for Diesel.

Part No.	Length	O.D. x I.D.
TUB2	30 m Coil	11 x 6 mm (1/4")
TUB3	30 m Coil	13 x 8 mm (5/16")
TUB4	30 m Coil	15 x 10 mm (3/8")
TUB5	30 m Coil	18 x 12 mm (1/2")

Windscreen Washer Accessories

Nylon. Suits 3/16" pipe.



Part No.	Qty	Description
TA103	5	T-Pieces



Part No.	Qty	Description
TA102	5	Elbows

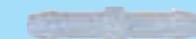

Part No.	Qty	Description
TA101	5	Straights



Part No.	Qty	Description
TA104	5	Small In-Line Valves



Part No.	Qty	Description
TA105	5	Large In-Line Valves

Assorted Pack of Windscreen Washer Accessories

Nylon. Suits 3/16" pipe.

Part No.	Pack of
AP61	25 Pieces

5 x Large In-Line Valves. 5 x Small In-Line Valves. 5 x Straights.
5 x Elbows. 5 x T-Pieces.





Cassette Hose Reel

15 m non-kink hose with fitted tap connector and spray nozzle. Supplied on an easy wind storage cassette.

Part No.	Qty	Description
TUB60	1	Cassette Hose Reel



Pressure Washer Hose

EN853. Complete with Male/Female BSP fittings at each end. Maximum Temperature: 100°C.

Part No.	Length	Diameter	Hose Type	Max Work Pressure
HY14	10 m	1/4" BSP	Single Wire	225 Bar
HY38	10 m	3/8" BSP	Single Wire	180 Bar
HY38D	10 m	3/8" BSP	Double Wire	330 Bar



Looking for Copper Tubing?

Our complete range of brake pipe and fittings is on Page 255



Looking for Whip Hoses

Our range of air tool whip hoses can be found on Page 226

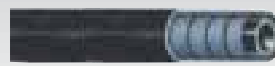

BEST SELLER

Air Line Hose

Black styrene-butadiene rubber (SBR). Working pressure: 20 bar.

Part No.	Length	O.D. x I.D.
AL11	15 m Coil	12 x 6 mm 1/4"
AL13	15 m Coil	15 x 8 mm 5/16"
AL17	15 m Coil	17 x 10 mm 3/8"
AL22	15 m Coil	21 x 13 mm 1/2"

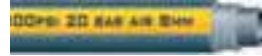

BEST SELLER

Air Line Hose - Black Rubber with Yellow Stripe

20 bar working pressure.

Part No.	Length	O.D. x I.D.
ALY8	15 m Coil	15 x 8 mm (5/16")
ALY10	15 m Coil	17 x 10 mm (3/8")
ALY12	15 m Coil	21 x 13 mm (1/2")

JAMEC PEM



NEW

JAMEC PEM Retractable Pro Series Air Hose Reel

Unique Helix Ultra-Coil hose layering system with 1 m leader hose and brass fittings. Dimensions: 360 x 330 x 220 mm. Max. Working Pressure: 300 PSI.

- Adjustable hose stopper
- High impact tough and durable polypropylene construction
- Fully enclosed weather resistant and UV stabilised outer case protects the hose and inner drum assembly against dirt and other contaminants
- Auto lock and rewind mechanism provides positive hose latching every full revolution of the hose drum
- Heavy duty mounting bracket with fixed in-line or optional 180° swivel mount is suitable for wall or overhead mounting
- Convenient carry handle located on the top panel for removing and refitting the hose reel from the mounting bracket

Part No.	Qty	Hose I.D. x Length	Hose O.D.
JPR1	1	9.2 mm (1/4") x 8 m	15.2 mm



High Visibility Safety PVC Air Hose

Manufactured in highly visible PVC for health and safety, CE certified. Complete with 1/4" BSP female brass fittings.

- Coated to resist oil and abrasions - Silicone FREE.
- Reinforced hose to resist crushing or twisting, will not kink.
- Maximum working pressure: 250 lbf/in² (17 bar).

Part No.	Length	Colour	O.D. x I.D.
AL76	10 m Coil	 Green	14 x 10 mm (3/8")

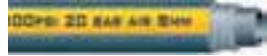

Air Line Assemblies with 1/4" BSP Swivel Nuts

Black rubber tubing with yellow stripe. Working pressure: 20 bar.

Part No.	Length	Diameter
ALY28	10 m Coil	15 x 8 mm (5/16")

JAMEC PEM



JAMEC PEM Retractable Pro Series Extreme Air Hose Reel

Unique Helix Ultra-Coil hose layering system with 2 m leader hose and brass fittings. Dimensions: 440 x 210 x 400 mm. Max. Working Pressure: 300 PSI.

- Adjustable hose stop
- Solid brass internal spindle
- High impact tough & durable polypropylene construction with a UV stabilised case
- 180° swivel wall mount bracket

Part No.	Qty	Hose I.D. x Length	Hose O.D.
JPR2	1	11 mm (3/8") x 15 m	17.0 mm
JPR3	1	9.2 mm (1/4") x 20 m	15.2 mm

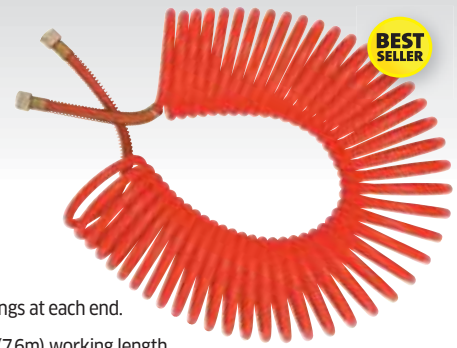

Air Line Coil

Nylon with protective springs at each end. 1/4" BSP swivel nuts. 3/8" O.D. x .265" I.D. 25 ft (7.6m) working length.

Part No.	Qty	Description
AL10	1	Air Line Coil



Air Line Assemblies with 1/4" BSP Swivel Nuts

Black styrene butadiene rubber (SBR). Working pressure: 20 bar.

Part No.	Length	O.D. x I.D.
AL63	10 m Coil	12 x 6 mm 1/4"
AL65	10 m Coil	15 x 8 mm 5/16"

PCL



PCL Multi Purpose PVC Air Hose Reel

Ideal for use with a multitude of applications where a wall or ceiling mounted reel is needed.

- Easy to use adjustable hose stopper
- Auto retract
- Built-in cleaning brush
- Copper tail outlet thread with dust cap
- Steel wall mounting 180° swivel bracket
- Supplied with fitted leader hose
- Large diameter inlet: Rp 1/4" Outlet: R 1/4"
- Maximum working pressure: 250 lbf/in² (17 bar)

Part No.	Qty	Hose I.D. x Length
ALR1	1	10 mm (3/8") x 15 m





BEST SELLER

PCL 'Airflow' Female Couplings

For portable air tools, garage and industrial air line systems and test panels.

Part No.	Pack of	Size	Fitting
AL101	5	1/4" BSP	Female



BEST SELLER

PCL 'Airflow' Male Couplings

For portable air tools, garage and industrial air line systems and test panels.

Part No.	Pack of	Size	Fitting
AL124	2	1/4" BSP	Male

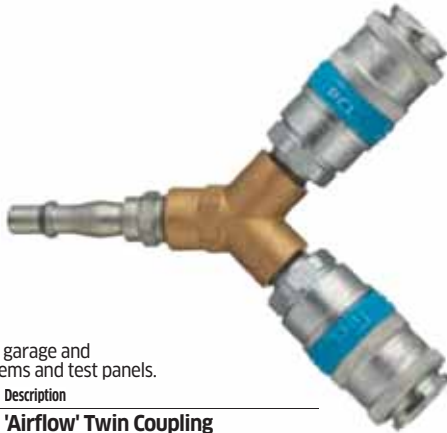

PCL 'Airflow' Twin Coupling

For portable air tools, garage and industrial air line systems and test panels.

Part No.	Qty	Description
AL23	1	'Airflow' Twin Coupling



BEST SELLER

PCL 'Vertex' Female Couplings

Slim profile and integral sleeve for trailing hoses. For portable air tools, garage and industrial air line systems.

Part No.	Pack of	Size	Fitting
AL31	5	1/4" BSP	Female



BEST SELLER

PCL 'Vertex' Male Couplings

Slim profile and integral sleeve for trailing hoses. For portable air tools, garage and industrial air line systems.

Part No.	Pack of	Size	Fitting
AL32	2	1/4" BSP	Male

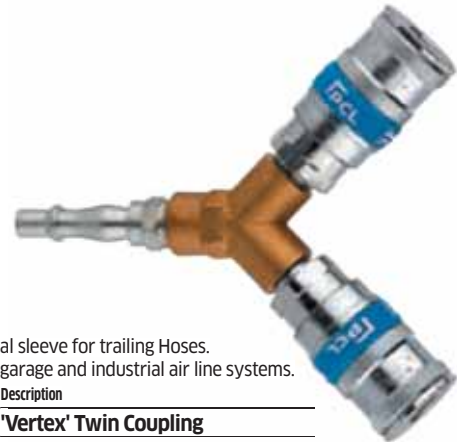

PCL 'Vertex' Twin Coupling

Slim profile and integral sleeve for trailing Hoses. For portable air tools, garage and industrial air line systems.

Part No.	Qty	Description
AL41	1	'Vertex' Twin Coupling



BEST SELLER

PCL Screwed Female Adaptors

Part No.	Pack of	Size	Fitting
AL12	5	1/4" BSP	Female



BEST SELLER

PCL Screwed Male Adaptors

Part No.	Pack of	Size	Fitting
AL3	5	1/4" BSP	Male



BEST SELLER

PCL Integral Adaptor/Tailpieces

Part No.	Pack of	Hose Bore	
AL4	5	6.35 mm	(1/4")
AL5	5	7.90 mm	(5/16")
AL38	5	9.50 mm	(3/8")



PCL 'Vertex' Coupling and Adaptors Kits

Slim profile and integral sleeve for trailing hoses. For portable air tools, garage and industrial air line systems.

Part No.	Qty	Hose Bore	
AL316	3 Piece Kit	6.35 mm	(1/4")
AL318	3 Piece Kit	7.9 mm	(5/16")
AL319	3 Piece Kit	9.5 mm	(3/8")

1 x 'Vertex' Coupling: 1/4" BSP Female. 1 x Male Screwed Adaptor: 1/4" BSP Male. 1 x Integral Adaptor/Tailpiece: 6.35 mm (1/4") Hose Bore.

JAMEC PEM

JAMEC PEM 2-Stage Female Coupling

TWO stage connection.

- Interchanges with UK equivalent
- Steel construction
- Max. airflow 43 cfm @ 100 psi
- Max. working pressure 200 psi / 14 bar

Part No. Pack of Tail/Thread Type Tail/Thread Size

JP31 5 Female 1/4"



NEW

JAMEC PEM

JAMEC PEM 2-Stage Male Coupling

TWO stage connection.

- Interchanges with UK equivalent
- Steel construction
- Max. airflow 43 cfm @ 100 psi
- Max. working pressure 200 psi / 14 bar

Part No. Pack of Tail/Thread Type Tail/Thread Size

JP32 2 Male 1/4"



NEW

JAMEC PEM

JAMEC PEM 1-Stage Female Coupling

One stage connection.

- Steel construction
- Interchanges with UK equivalent
- Max. airflow 43 cfm @ 100 psi
- Max. working pressure 200 psi / 14 bar

Part No. Pack of Tail/Thread Type Tail/Thread Size

JP101 5 Female 1/4"



NEW

JAMEC PEM

JAMEC PEM 1-Stage Male Coupling

One stage connection.

- Steel construction
- Interchanges with UK equivalent
- Max. airflow 43 cfm @ 100 psi
- Max. working pressure 200 psi / 14 bar

Part No. Pack of Tail/Thread Type Tail/Thread Size

JP124 2 Male 1/4"



NEW



PCL 'SafeFlow' Female Couplings

Two stage self-venting release.
Conforms to ISO 4414:1998 and EN 983:1.

- Safe and simple to use.
- Enhances workshop safety - Prevents hose whip.
- Compatible with standard PCL 'Airflow' and 'Vertex' adaptors.

Part No. Qty Size Fitting

AL161 1 1/4" BSP Female



PCL 'SafeFlow' Male Couplings

Two stage self-venting release.
Conforms to ISO 4414:1998 and EN 983:1.

- Safe and simple to use.
- Enhances workshop safety - Prevents hose whip.
- Compatible with standard PCL 'Airflow' and 'Vertex' adaptors.

Part No. Qty Size Fitting

AL162 1 1/4" BSP Male



JAMEC PEM

JAMEC PEM Screwed Male Adaptor

Steel construction.

Adaptors fit both the one stage and two stage couplings.

Part No. Pack of Tail/Thread Type Tail/Thread Size

JP3 5 Male 1/4"



NEW

JAMEC PEM

JAMEC PEM Screwed Female Adaptor

Steel construction.

Adaptors fit both the one stage and two stage couplings.

Part No. Pack of Tail/Thread Type Tail/Thread Size

JP12 5 Female 1/4"



NEW

JAMEC PEM

JAMEC PEM Integral Adaptor/Tailpiece

Steel construction.

Adaptors fit both the one stage and two stage couplings.

Part No. Pack of Tail/Thread Type Tail/Thread Size

JP38 5 Hose Tail 3/8" (10 mm)



NEW





BEST SELLER

PCL 'XF' High Flow Female Couplings

For most applications.

Part No.	Qty	Thread Size	Fitting
AL201	1	1/4" BSP	Female
AL203	1	3/8" BSP	Female



BEST SELLER

PCL 'XF' High Flow Male Couplings

For most applications.

Part No.	Qty	Thread Size	Fitting
AL202	1	1/4" BSP	Male
AL204	1	3/8" BSP	Male



BEST SELLER

PCL 'XF' High Flow Male Screwed Adaptors

For most applications.

Part No.	Pack of	Thread Size	Fitting
AL222	5	1/4" BSP	Male
AL232	5	3/8" BSP	Male



PCL 'XF' High Flow Female Screwed Adaptors

For most applications.

Part No.	Pack of	Thread Size	Fitting
AL221	5	1/4" BSP	Female
AL231	5	3/8" BSP	Female



PCL 'XF' High Flow Integral Adaptor/Tailpieces

For most applications.

Part No.	Pack of	Hose Bore	
AL206	5	6 mm	(1/4")
AL208	5	8 mm	(5/16")
AL210	5	10 mm	(3/8")
AL213	5	13 mm	(1/2")



NEW

JAMEC PEM Euro Style High Flow Female Coupling

Anti release flange. Use in large air consumption applications.

- Interchanges with CEJN equivalent
- Steel construction
- Max. airflow 62 cfm @ 100 psi
- Max. working pressure 200 psi / 14 bar
- Use with euro adaptors

Part No.	Qty	Tail/Thread Type	Tail/Thread Size
JP201	1	Female	1/4"



NEW

JAMEC PEM Euro Style High Flow Male Coupling

Anti release flange. Use in large air consumption applications.

- Interchanges with CEJN equivalent
- Steel construction
- Max. airflow 62 cfm @ 100 psi
- Max. working pressure 200 psi / 14 bar
- Use with euro adaptors

Part No.	Qty	Tail/Thread Type	Tail/Thread Size
JP202	1	Male	1/4"



NEW

JAMEC PEM Euro Style High Flow Female Adaptor

Anti release flange. Steel construction. Use in large air consumption application.

- Airflow 115 cfm, 3275 L/mm @ 100 psi, 690 kPa
- Max. working pressure 152 psi, 1050 kPa
- Use with euro couplings and interchanges with CEJN equivalent

Part No.	Pack of	Tail/Thread Type	Tail/Thread Size
JP221	5	Female	1/4"



NEW

JAMEC PEM Euro Style High Flow Male Adaptor

Anti release flange. Steel construction. Use in large air consumption application.

- Airflow 115 cfm, 3275 L/mm @ 100 psi, 690 kPa
- Max. working pressure 152 psi, 1050 kPa
- Use with euro couplings and interchanges with CEJN equivalent

Part No.	Pack of	Tail/Thread Type	Tail/Thread Size
JP222	5	Male	1/4"

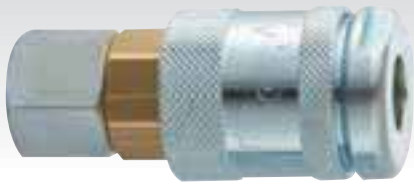

PCL '60 Series' Female Couplings

For general industrial applications.

Part No.	Qty	Thread Size	Fitting
AL261	1	1/4" BSP	Female
AL263	1	3/8" BSP	Female



PCL '60 Series' Male Couplings

For general industrial applications.

Part No.	Qty	Thread Size	Fitting
AL262	1	1/4" BSP	Male
AL264	1	3/8" BSP	Male



PCL '60 Series' Screwed Adaptors

For general industrial applications.

Part No.	Pack of	Thread Size	Fitting
AL265	3	1/4" BSP	Male
AL266	3	3/8" BSP	Male



PCL '60 Series' Integral Adaptor/Tailpieces

For general industrial applications.

Part No.	Pack of	Hose Bore	
AL267	3	9.50 mm	(3/8")
AL268	3	12.70 mm	(1/2")

JAMEC PEM



JAMEC PEM Stop-Flo Valves

Safety valve can be easily fitted directly to the outlet of a compressor or the fixed outlet of airline system preventing potential whip hose damage from any accidental disconnection

Part No.	Qty	Valve Size	Hose Size Required
JP80	1	3/8"	10.0 mm (3/8") Hose
JP81	1	1/2"	12.5 mm (1/2") Hose



BEST SELLER

PCL '100 Series' Female Couplings

For general industrial applications.

Part No.	Qty	Size	Fitting
AL46	1	3/8" BSP	Female
AL18	1	1/2" BSP	Female



PCL '100 Series' Male Couplings

For general industrial applications.

Part No.	Qty	Size	Fitting
AL47	1	3/8" BSP	Male
AL34	1	1/2" BSP	Male



PCL '100 Series' Male Screwed Adaptors

For general industrial applications.

Part No.	Pack of	Size	Fitting
AL48	3	3/8" BSP	Male
AL19	3	1/2" BSP	Male



PCL '100 Series' Integral Adaptor/Tailpieces

For general industrial applications.

Part No.	Pack of	Hose Bore	
AL49	3	9.50 mm	(3/8")
AL20	3	12.70 mm	(1/2")



PCL '100 Series' Coupling and Adaptors Kit

For general industrial applications.

Part No.	Qty	Hose Bore	
AL180	3 Piece Kit	12.7 mm	(1/2")

1 x '100 Series' Coupling: 1/2" BSP Male. 1 x Male Screwed Adaptor: 1/2" BSP Male. 1 x Integral Adaptor/Tailpiece: 12.7 mm (1/2") Hose Bore.





PCL Double-Ended Hose Connectors

Part No.	Pack of	Bore Hose	
AL56	5	6.35 mm	(1/4")
AL57	5	7.90 mm	(5/16")
AL58	5	9.50 mm	(3/8")
AL59	5	12.70 mm	(1/2")

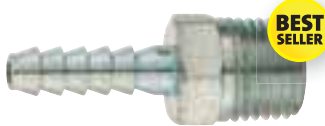

BEST SELLER

PCL Male Screwed Tailpieces - 1/4" BSPT

Part No.	Pack of	Bore Hose	
AL2	5	6.35 mm	(1/4")
AL37	5	7.90 mm	(5/16")
AL33	5	9.50 mm	(3/8")
AL53	5	12.70 mm	(1/2")



PCL Male Screwed Tailpieces - 3/8" BSPT

Part No.	Pack of	Bore Hose	
AL54	5	9.50 mm	(3/8")
AL55	5	12.70 mm	(1/2")



PCL Male Screwed Tailpieces - 1/2" BSPT

Part No.	Pack of	Bore Hose	
AL39	3	12.70 mm	(1/2")



BEST SELLER

PCL Air Line Fittings - Double Union

Part No.	Pack of	Size
AL8	5	1/4" BSP



PCL Air Line Fittings - Parallel Socket

Part No.	Pack of	Size
AL50	5	1/4" BSP



PCL Air Line Fittings - Reducing Bush

Part No.	Pack of	Type	Size
AL51	5	M : F	1/2" BSPT : 1/4" BSPP



PCL Air Line Fittings - Reducing Union

Part No.	Pack of	Type	Size
AL52	5	M : M	1/2" BSPT : 1/4" BSPT



PCL Air Line Fittings - Tailpieces & Nuts

Part No.	Pack of	Tail Piece	Nut Size
AL67	5 Pairs	6.35 (1/4") Bore Hose	1/4" BSP



KS TOOLS 1/4" Compressed Air Side Oiler

For air tool lubrication. Assembly directly in the air feed line.

Part No.	Qty	Description
K515.3360	1	Air Side Oiler



KS TOOLS 1/4" Compressed Air Water Trap

For separating condensation. Sintered metal cartridge, trap drain valve. Assembly directly in the air feed line.

Part No.	Qty	Description
K515.3370	1	Air Water Trap



KS TOOLS 1/4" Z-Swivel Air Line Connector

Allows 360° rotation making movement of airline easier.

Part No.	Qty	Description
K515.3396	1	Z-Swivel Connector





BEST SELLER

PCL 1/4" Blow Gun

Moulded resin body with ergonomic handle. Maximum working pressure: 18 bar.

Part No.	Qty	Description
AL35	1	Blow Gun



KS TOOLS Air Operated Blow Pistol with Air Flow Control

Durable plastic housing. Air flow can be finely regulated. Includes universal nozzle. 1/4" connection. Includes 1/4" air inlet connector. Length: 100 mm.

Part No.	Qty	Description
K515.1901	1	Blow Pistol



KS TOOLS Telescopic Air Operated Blow Pistol

Durable plastic housing. Includes universal nozzle. 1/4" air inlet connector. Telescopic blow pistol can be adjusted in length (65 - 280 mm) & angle (360°).

Part No.	Qty	Description
K515.1907	1	Telescopic Blow Pistol



PCL Palm Blow Gun

Supplied with conical and safety nozzles. Manufactured from high quality die-cast alloy. Air flow: 247 l/min (8.9 cfm).

Part No.	Qty	Connection
AL78	1	1/4" BSP Female



NEW

JAMEC PEM Blowgun

100 mm with angle nozzle.

- Brass inlet 1/4"
- Durable ABS plastic
- Variable air flow

Part No.	Qty	Inlet Thread
JP35	1	1/4" Female



NEW

JAMEC PEM Blowgun - Rubber Tip

100 mm with angle nozzle and rubber tip.

- Brass inlet 1/4"
- Variable air flow
- Durable ABS plastic
- Anti-Scratch rubber tip

Part No.	Qty	Inlet Thread
JP37	1	1/4" Female



NEW

JAMEC PEM Blowgun - Flexible 600mm Nozzle

600 mm flexible nozzle.

- Brass inlet 1/4"
- Durable ABS plastic
- Variable air flow
- 600 mm flexible nozzle

Part No.	Qty	Inlet Thread
JP36	1	1/4" Female

Looking for Whip Hoses?

Our range of air tool whip hoses are overleaf





FUCHS 'Silkair VG22' Air Line Oil

General purpose. Lubricates pneumatic tools and equipment. Readily separates from water.

Part No.	Qty	Size
VC191	1	1 Litre Bottle



PCL Air Tool Whip Hose

0.6 m (2 ft) length. Adaptor and BSP male tailpiece ends. Fully conforms to safety standard requirements ISO 4414:1998 and EN983:1996. Prevents Hose whip. Allows safe disconnection.

Part No.	Qty	Hose I.D.	Hose O.D.	Adaptor x Male Thread
AL60	1	7 mm (1/4")	14 mm	Standard x R 1/4
AL72	1	10 mm (3/8")	17 mm	Standard x R 3/8
AL73	1	13 mm (1/2")	21 mm	100 Series x R 1/2

JAMEC PEM



JAMEC PEM Air Tool Whip Hose

0.6 m (2 ft) length. Adaptor and BSP male tailpiece ends.

Part No.	Qty	Hose I.D.	Hose O.D.	Adaptor x Male Thread
JP60	1	10 mm (1/4")	15.5 mm	Standard x R 1/4
JP72	1	10 mm (3/8")	15.5 mm	Standard x R 3/8

Looking for Abrasive Discs?

Our range of 'mini' abrasives can be found on Page 404



PCL 3/8" Drive 'Mini' Pneumatic Ratchet - 27.5 Nm

Palm Ratchet allows the operator to reach small areas. Compact and lightweight design allows maximum operator control and performance. Rear exhaust to keep airflow away from work area. High power motor for consistent performance. Maximum Torque 27.5 Nm, Weight 0.4 kg.

3/8"

Part No.	Qty	Description
ALT7	1	3/8" Mini Ratchet



PCL 1/4" Drive 'Mini' Pneumatic Ratchet - 27.5 Nm

Palm Ratchet allows the operator to reach small areas. Compact and lightweight design allows maximum operator control and performance. Rear exhaust to keep airflow away from work area. High power motor for consistent performance. Maximum Torque 27.5 Nm, Weight 0.3 kg.

1/4"

Part No.	Qty	Description
ALT6	1	1/4" Mini Ratchet



PCL 'Mini' Pneumatic Die Grinder

Allows the operator to reach into very small areas. Safety lever prevents any possible accidents. Rear exhaust to keep airflow away from the hand. High power motor designed for all tight grinding situations. 6 mm collet (3 piece design). Free speed 25,000 RPM, Weight 0.34 kg.

Part No.	Qty	Description
ALT8	1	Mini Die Grinder



PCL 'Mini' Pneumatic Orbital Sander

Complete with small 50 mm (2") sanding pad allows the operator to reach small areas. Random orbit allows maximum operator control and finish. Rear exhaust to keep airflow away from the hand. High power motor designed for efficient sanding.

Part No.	Qty	Description
ALT9	1	Mini Orbital Sander



PCL 1/2" Drive Pneumatic Impact Wrench - 540 Nm

General purpose impact wrench with forward and reverse mode.
Pin clutch hammer mechanism with 4 forward operation impact settings, non-slip comfort grip.
Air Consumption: 300 l/min,
Maximum Torque: 540 Nm at 90 PSI,
Sound: 96.6 db (A), Vibration: 1.39 m/s² Weight: 2.0 kg.

Part No.	Qty	Description
ALT1	1	1/2" Impact Wrench



PCL 10 mm (3/8") Pneumatic Reversible Drill

Ideal for drilling, reaming and honing.
Side mounted forward/reverse shift,
fitted with 10 mm (3/8") keyless chuck.
Free speed 1,800 RPM, Air Consumption 130 l/min, Sound 87 db (A),
Vibration 1.5 m/s² Weight 1.1 kg.

Part No.	Qty	Description
ALT3	1	10 mm Reversible Drill



PCL Pneumatic Orbital Sander

Two handed operation.
Insulated handle and motor housing. Includes 150 mm backing pad for 150 mm diameter self-adhesive abrasives. Free speed 1,800 RPM,
Air Consumption 130 l/min, Sound 87 db (A), Vibration 1.5 m/s² Weight 1.1 kg.

Part No.	Qty	Description
ALT5	1	Orbital Sander



PCL 3/8" Drive Pneumatic Ratchet

Forward and reverse knob on the ratchet head.
Ball type retainer with easy forward/reverse shift.
Maximum Torque 60 Nm at 90 PSI, Air Consumption 115 l/min,
Sound 90.0 db (A), Vibration 5.2m/s² Weight 1.2 kg.

Part No.	Qty	Description
ALT2	1	3/8" Ratchet



PCL Pneumatic Die Grinder

Ideal for tyre buffing, polishing and grinding.
Medium motor with high velocity and low vibration,
safety throttle lever with 6 mm collet (3 piece design).
Free speed 22,000 RPM, Air Consumption 115 l/min, Sound 93 db (A),
Vibration 5.4 m/s² Weight 0.6 kg.

Part No.	Qty	Description
ALT4	1	Die Grinder



Air Operated Grease Gun

Complete with extension pipe
and 4-jaw hydraulic connector.
Takes 400g cartridge or bulk feed.

Part No.	Qty	Description
TL920	1	Grease Gun





FASTMOVER Spray Gun - Conventional

Gravity feed compliant.
Can be used with 3M disposable pot system
use adaptor number 2 (3M code 16032).
Working pressure: 50 PSI. Maximum pressure:
80 PSI. Air consumption:
Between 7-12 CFM (depending on setup).

- Designed and built for tough work.
- Suitable for solvent based paints only.

Part No.	Qty	Pot Capacity	Set up
ALG1	1	600 cc	1.7 mm



FASTMOVER Undercoating Gun

Under body coating gun.
Screws onto a standard tin of underbody
coating material and creates a venturi
action that sucks up the material and
pushes it through the gun nozzle.
Complete with plastic extension probe.
Operates at 90 PSI (6 bar).

- Ideal a workshop for applying underbody material to vehicles, also a great tool for DIY and classic car restorers.

Part No.	Qty	Inlet Thread
ALG4	1	1/4" BSP



FASTMOVER Spray Gun - HVLP

Gravity feed compliant.
Can be used with 3M disposable pot system
use adaptor number 2 (3M code 16032).
Working pressure: 43-50 PSI.
Air consumption:
Between 7-10 CFM (depending on setup).

- Suitable for topcoat work.
- Ergonomically designed.
- Designed to produce superior finish - Gives a fast flow and wide spray pattern.
- HVLP (High Volume Low Pressure) - makes it efficient and compliant.

Part No.	Qty	Pot Capacity	Set up
ALG3	1	600 cc	1.3 mm



FASTMOVER Paint Drying Air Gun

Venturi hand held water based paint drying gun.
Working pressure: 4-7 PSI (3-5 bar).
Max Pressure: 100 psi (7 bar).
Air consumption: 12.3 CFM.

- Increases airflow from compressor by 15% which speeds up drying times.
- Air is filtered to a high degree eliminating risks of imperfections in the paintwork.

Part No.	Qty	Inlet Thread
ALG5	1	1/4" BSP



FASTMOVER Spray Gun - Mini HVLP

Gravity feed compliant. Stainless steel components,
suitable for use with water and solvent based paints.
Can be used with 3M disposable pot system
use adaptor number 21 (3M code 16105).
Thread size: M14. Weight: 320g. Working pressure: 43 PSI.

- Extra small and lightweight.
- Ideal for SMART touch-up paint repairs and perfect for alloy wheel painting.
- A wide spray pattern with excellent atomisation.

Part No.	Qty	Pot Capacity	Set up
ALG2	1	125 ml	0.8 mm



Air Regulator/Gauge

Length: 32 mm. Weight: 100g.
Glass lens unaffected by the solvents.
Working pressure range: 7-114 PSI (0.5-7.8 bar).

- Extra small and lightweight.

Part No.	Qty	Inlet Thread
ALG10	1	1/4" BSP





NEW

PCL Direct Drive Compressor Unit

Solid, stable and completely portable direct drive compressor.

- Fitted with genuine single stage 2 HP motor
- Air receiver: 24 l. Air Flow: 206 l/min / 7.3 cfm
- Noise: 82 DbA
- Fitted with genuine PCL 'Airflow' couplings on the outlet
- Supplied with full CE certification, test certificates & operating manual

Part No.	Qty	Size	Weight
AL89	1	59 x 28 x 62 cm	26 kg



LASER Air Gun Vacuum/Blower Kit

Supplied in a storage box. Complete with nozzles, dust bag, brush and mini hose. Standard 1/4" BSP air inlet. Air pressure: 90 PSI.

- Ideal for sucking up or blowing away debris from shattered windscreens, carbon deposits, etc.

Part No.	Qty	Description
TL7410	1 Set	6 Piece Set



NEW

JAMEC PEM Digital Wall Mounted Tyre Inflator - Die Cast Case and Metal Buttons

Robust die cast aluminium housed digital auto inflator - simple to use with plug and play design.

- Accuracy exceeds EC Standards
- Multi-scale gauge
- Tough die cast aluminium body
- OPS (Over Pressure Setting) function for seating tyres on rims
- Mechanical anti-vandal buttons
- Comprehensive diagnostics and error reporting
- Inflates accurately with hoses up to 50 m long
- Comes with instruction manual and calibration certificate

Part No.	Qty	Type	Style	Hose Length
JP501	1	Single Clip-On	Straight	7.6 m



NEW

JAMEC PEM Digital Wall Mounted Tyre Inflator with Over Pressure - Plastic Case

Simple to use with plug and play design, pre-set the required pressure, place the chuck on the tyre valve and the built-in auto start inflates/deflates the tyre to the specified pressure.

- Accuracy exceeds EC Standards
- Multi-scale gauge
- Backlit display
- OPS (Over Pressure Setting) function used for seating tyres on rims
- Two programmable pre-set buttons
- Comprehensive diagnostics and error reporting
- Inflates accurately with hoses up to 50 m long
- Comes with instruction manual and calibration certificate

Part No.	Qty	Type	Style	Hose Length
JP502	1	Single Clip-On	Straight	10 m



Looking for Tyre Air Compressors?

Our expanded range of air compressors start from Page 234



JAMEC PEM



JP342



JP344

**JAMEC PEM
TDR3000
Digital Tyre Inflator**

Tough aluminium housing with large LCD display. Accurate multi-scale gauge with auto ON/OFF.

- Rubber grip
- Tough die cast aluminium body
- Accuracy exceeds EC Standards
- Multi-scale gauge
- Backlit display
- Wire sheathed hose eliminates kinking
- Impact absorbing bumpers
- Supplied with instruction manual and calibration certificate



NEW

JP314

Part No.	Qty	Type	Style	Hose Length
JP314	1	Twin Hold-On	Angle	0.5 m
JP342	1	Twin Clip-On	Angle	2.7 m
JP344	1	Single Clip-On	Straight	1.8 m

JAMEC PEM

**JAMEC PEM
TDR4000
Digital Tyre Inflator**

Lightweight, durable design and one touch operation, perfect for industrial workshops, mechanics and garages.

- Auto on, upon sensing air pressure
- IP44 rating - tough, durable and splash resistant
- Large, tilted easy to read LCD display with backlight
- Auto off after 90 seconds
- Multi-scale gauge (psi, kPa, bar, kgF)
- Impact absorbing bumper
- Tough, lightweight diecast aluminium internal body with composite outer casing
- Wire sheathed hose to eliminate kinking
- Supplied with certificate of calibration
- 80 hours continuous use
- 2 x AAA batteries included



NEW

Part No.	Qty	Type	Style	Hose Length
JP414	1	Single Clip-On	Straight	0.5 m

JAMEC PEM



NEW



JP14
JP42

**JAMEC PEM
Classic Tyre Inflator**

This classic Tyre Inflator has a slimlined design and is easy to hold. Designed to meet EC standards and constructed in die cast aluminium for lightweight ease of use.

- Dual scale standard calibration: 0-138 psi and 0-9.6 bar
- Supply pressure max: 200 psi
- Wire sheathed hose eliminates kinking
- Ergonomically designed trigger with two click action
- Supplied with a certificate of calibration and instruction manual
- Complies with EN12645: 2014



JP44

Part No.	Qty	Type	Style	Hose Length
JP14	1	Twin Hold-On	Angle	0.5 m
JP42	1	Twin Clip-On	Angle	2.7 m
JP44	1	Single Clip-On	Straight	2.7 m

JAMEC PEM

**JAMEC PEM
Digital Hand Held
Preset Tyre Inflator**

A truly portable automatic inflator/deflator. Powered by a rechargeable Lithium-Ion battery, lasting up to an impressive 15 hours (continuous use).

- Accuracy exceeds EC Standards
- Multi-scale gauge
- Backlit display
- Wire sheathed hose eliminates kinking
- Includes AC adaptor for charging
- Includes Nitto equivalent adaptor
- Tough poly carbonate / ABS body
- OPS function used for seating tyres on rims
- Two programmable pre-set buttons
- Comes with instruction manual and calibration certificate



NEW

Part No.	Qty	Type	Style	Hose Length
JP100	1	Single Clip-On	Straight	2.7 m

Looking for Wall Mounted Tyre Inflators

Our new range of wall mounted tyre inflators are on Page 229





PCL 'ACCURA MK4' Digital Tyre Inflator

Extremely robust aluminium body with protective rubber bumper.

- Small 'stubby' body is the lightest metal bodied digital inflator on the market
- Higher pressure range for multiple applications: 4 - 250 PSI
- Permanently backlit in use, auto off after 10 seconds no use
- IP54 rated for protection against splashing water for use indoors and outdoors

Part No.	Qty	Type	Hose Length
AL84	1	Twin Hold-On	0.53 m (21")
AL85	1	Single Clip-On	0.53 m (21")
AL86	1	Twin Clip-On	1.8 m (6 ft)
AL87	1	Single Clip-On	1.8 m (6 ft)



PCL 'Mk4' Air Line Gauge

Maximum pressure: 9.9 bar (138 PSI).

Part No.	Qty	Type	Hose Length
AL14	1	Twin Hold-On	0.53 m (21")
AL42	1	Twin Clip-On	2.7 m (9') Tyre Shop
AL81	1	Single Clip-On	0.53 m (21")
AL82	1	Single Clip-On	2.7 m (9 ft) Tyre Shop



PCL 'ACCURA 1' Handheld Digital Tyre Inflator

Approved to German standard PTB 8.08/06.04 and to BS EN 12645 : 2014.

- Light weight
- Shock resistant
- Easy to read digital display
- Maximum inflation pressure of 12 bar, resolution 0.01 bar, inflation flow 910 l/min at 13 bar
- Supply & operating temperature: -20° C to 60° C

Part No.	Qty	Type	Hose Length
AL83	1	Single Clip-On	1.8m (6ft)



PCL Handheld Digital Tyre Inflator

- Large, clear, easy to read display with backlight
- Reliable accuracy (+/- 1psi up to 60 psi, then 2 psi up to 150 psi) with individual testing and certification
- Suitable for all applications including tyreshop environments
- Pressure Range: 5 - 170 psi / 0.34 - 12 bar / 34 - 1200 kPa. Maximum Supply Pressure: 218 psi / 15 bar / 150 kPa. Inflation flow: 910 l/min

Part No.	Qty	Type	Hose Length
AL88	1	Single Clip-On	1.8 m (6 ft)

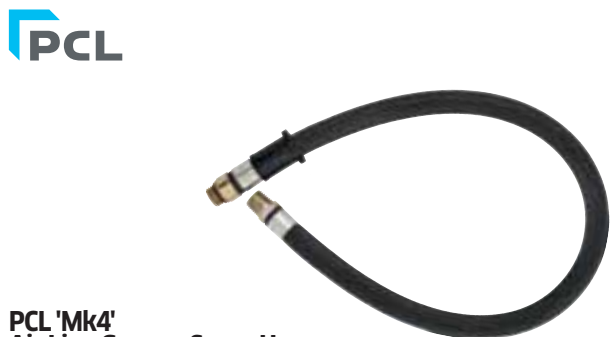

PCL 'Mk4' Air Line Gauge - Spare Hose

Complete with tailpiece.

Part No.	Qty	Length
AL14H	1	0.53 m (21")



PCL 'Tyre Shop' Air Line Gauge - Spare Hose

Complete with tailpiece.

Part No.	Qty	Length
AL42H	1	2.7 m (9')





PCL Alloy Tyre Inflator

A general purpose tyre inflator with an all alloy body with rubber protected gauge. Dual calibrated: 10-210 lbf/in² and 0.7-15 bar. Simple and easy to use. Ideal for general low volume tyre inflation.

Part No.	Qty	Type	Hose
AL40	1	Single Clip-On	0.85 m



PCL Dial Type Air Line Gauge Tyre Inflator

Maximum pressure: 170 PSI.

Part No.	Qty	Type	Hose Length
AL43	1	Single Clip-On	1.8 m (6')

JAMEC PEM



JAMEC PEM TDR5000 Dial Gauge Tyre Inflator

Lightweight, durable design ideal for industrial workshops, mechanics and garages.

- IP44 rating - tough, durable and splash resistant
- Large 80 mm dial gauge
- Multi-scale gauge (psi, bar)
- Impact absorbing bumper
- Tough, lightweight diecast aluminium internal body with composite outer casing
- Wire sheathed hose to eliminate kinking
- Supplied with certificate of calibration

Part No.	Qty	Type	Hose Length
JP43	1	Single Clip On	0.5 m



PCL Tyre Valve Connectors - Twin Hold-on Open End

Part No.	Qty	Description
AL15	1	Twin Hold-on Open End



PCL Tyre Valve Connectors - Twin Hold-on Closed End

Part No.	Qty	Description
AL16	1	Twin Hold-on Closed End



BEST SELLER

PCL Tyre Valve Connectors - Twin Clip-on Open End

Part No.	Qty	Description
AL25	1	Twin Clip-on Open End



PCL Tyre Valve Connectors - Twin Clip-on Closed End

Part No.	Qty	Description
AL70	1	Twin Clip-on Closed End

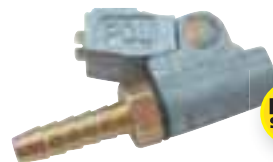

BEST SELLER

PCL Tyre Valve Connectors - Single Clip-on Open End

For 6.35 mm bore hose.

Part No.	Qty	Description
AL61	1	Single Clip-on Open End

JAMEC PEM



JAMEC PEM Tyre Valve Connectors - Single Clip-On

Non sealing.

Part No.	Qty	Description
JP61	1	Single Clip-On

JAMEC PEM



NEW

JAMEC PEM Valve Connectors - Twin Hold-On - Open End

Non sealing. Rubber grip.

Part No.	Qty	Description
JP15	1	Twin Hold-on Open End

JAMEC PEM



NEW

JAMEC PEM Valve Connectors - Twin Hold-On - Closed End

Sealing. Rubber grip.

Part No.	Qty	Description
JP16	1	Twin Hold-on Closed End

JAMEC PEM



NEW

JAMEC PEM Valve Connectors - Twin Clip-On - Open End

Rubber grip.

Part No.	Qty	Description
JP25	1	Twin Clip-on Open End

JAMEC PEM



NEW

JAMEC PEM Valve Connectors - Twin Clip-On - Closed End

Rubber grip.

Part No.	Qty	Description
JP70	1	Twin Clip-on Closed End

PCL



PCL Tyre Pressure Gauges - Universal Type

Calibrated scale: 10 -160 lbf/in² & 0.8 -11.0 bar.

Part No.	Qty	Description
AL28	1	Universal Type

PCL



PCL Tyre Pressure Gauges - Pocket Type In-Line Head

Calibrated scale: 6 - 50 lbf/in² & 0.5 - 3.4 bar in 0.1 bar units.

Part No.	Qty	Description
AL45	1	Pocket Type In-Line Head

PCL

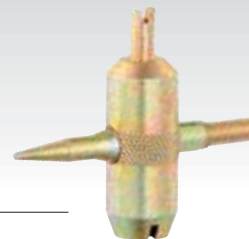

PCL Tyre Valve Tool

Part No.	Qty	Description
AL27	1	Tyre Valve Tool

PCL



NEW

PCL Digital Tyre Pressure & Tread Depth Gauge

- Self-calibrating with a 90 second auto power off function
- Calibration: 0 - 100 psi & 0 - 0.8"

Part No.	Qty	Description
AL95	1	Digital Tyre Pressure/Tread Depth Gauge

RING



RING Digital Tyre Pressure & Tread Depth Gauge

Complete with soft storage case. Supplied with 1 x CR2032 battery.

- Built in tread depth gauge.
- 360° swivel head provides easier access to tyre valve.
- Extra large digital display.
- Measures up to 99 PSI in PSI, bar, KPA & kg /cm².

Part No.	Qty	Description
AL79	1	Digital Tyre Pressure/Tread Depth Gauge

RING



RING Digital Tyre Pressure Gauge

Complete with soft storage case. Supplied with 1 x CR2032 battery.

- 360° swivel head provides easier access to tyre valve.
- Extra large digital display.
- Measures up to 99 PSI in PSI, bar, KPA & kg /cm².

Part No.	Qty	Description
AL71	1	Digital Tyre Gauge

PCL



BEST SELLER

PCL Tyre Tread Depth Gauges

1.6 mm markings. Complies with EC directive 89/459/EEC.

- DVSA approved (previously VOSA)

Part No.	Pack of	Description
AL29	5	Tread Depth Gauges

Digital Tyre Pressure Gauges





RING 12V Digital Automatic Tyre Air Compressor

Fitted with 12V in-vehicle charging plug. Complete with handy storage case.

- Inflates a tyre in 3 minutes (Approx. based on a 13" tyre)
- Pre-set pressure mode with automatic cut off
- Tyre deflation valve
- Red SOS light
- High intensity LED light



Part No.	Qty	Description
ERAC630	1	12V Digital Automatic Air Compressor



RING 12V 4 x 4 Tyre Air Compressor

Suitable for 4 x 4 and standard tyres. Fitted with quick release 12V battery clips. Complete with 3 piece adaptor kit, 7m flexible air hose with tyre valve locking system.

- Inflates a tyre in under 4 minutes (Approx. based on inflating a tyre to 35 PSI).
- Pressure gauge in PSI, bar, & kg/cm².
- Carry handle.
- Anti-vibration rubber mounted feet.
- On/Off switch.
- Fitted with fused cigarette lighter plug.
- Flow rate 36 litres per min.



Part No.	Qty	Description
ERAC700	1	12V '4 x 4' Air Compressor



NEW



PCL Foot Pump

Complete with air bed, cycle valve & football adapters.

- Preset dial gauge
- Single steel barrel

Part No.	Qty	Description
AL80	1	Foot Pump



RING 12V Heavy Duty Tyre Air Compressor Kit

Up to 3 x faster than a standard compressor. Fitted with fused 12V power plug to protect vehicle electronics. Complete with flexible hose with quick release inflator/deflator and large gradient pressure gauge, industrial style brass nozzle and 7 m coiled air line hose. Supplied in a durable storage bag with carry handle.

- Inflates a tyre in less than 90 seconds (Approx. based on inflating a tyre to 35 PSI)
- Thermal overload protection
- Waterproof On/Off switch
- Anti-vibration rubber mounted feet
- Pressure gauge in PSI, bar, KPA & kg/cm²
- Flow rate 55 litres per min
- 2 year guarantee



Part No.	Qty	Description
ERAC900	1	12V Heavy Duty Air Compressor Kit



RING 'Tyre Repair' Emergency Puncture Repair Sealant

Single use product.

Will NOT repair tyres that have come off the rim, are ripped, have punctures larger than 5 mm or have damaged walls.

- For tyres up to and including 16"
- Provides a temporary repair designed to get you home, no need for any tools or wheel changes

Part No.	Qty	Size
RTS1	1	400ml Aerosol



NEW

RING 12V Heavy Duty 4 x 4 Digital Air Compressor

Fitted with 12V in-vehicle charging plug.

Supplied with storage case and 3 piece adaptor set for small inflatables and bikes

- Ideal for 4 x 4's, SUVs and vans
- Inflates 4 x 4 tyre in 5 minutes and a car tyre in 2.5 minutes
- Simple set up - Rotate dial to set pressure
- Quick set auto stop - Stops inflating once preset pressure is reached
- Built-in LED light for safer night time use

Part No.	Qty	Description
ERAC820	1	12V Digital Heavy Duty Air Compressor



NEW

RING Handheld Rechargeable Tyre Air Compressor

Max pressure reading: 120 PSI. Cordless, robust design and small size. Includes 2 piece adaptor kit for other inflatables and built in 14.5 cm air line. Complete with handy bike bracket and storage bag. Perfect in an emergency.

- Ideal for cars, motorbikes, bikes, scooters and other inflatables
- Can top up a car tyre in <3 mins or a inflate a bicycle tyre from flat in <2 mins
- 4 programmable pressure settings with digital autostop for ease of use
- Rechargeable with Powerbank function via the USB outlet
- Compact design for easy storage - Fits in most bicycle water bottle holders
- Easy to read digital display
- LED light - Torch facility

Part No.	Qty	Description
ERTC2000	1	Handheld Tyre Air Compressor



NEW

RING 12V Cordless 4-in-1 Digital Tyre Air Compressor

Supplied with storage case, 10 piece adaptor set for bikes, air beds and other inflatables, 4 x spare valve caps, 1 x spare fuse and 1 x pair gloves.

- Inflates a tyre or a single air bed in 2 minutes
- Quick setting digital gauge automatically stops at set pressure
- Measures in PSI, BAR and kPA
- Handy on board power bank - USB output 2.4A
- Additional 230V AC power cable included for recharging
- Fitted with a 3.5m power cable and fused 12V DC power plug for use if rechargeable battery is fully discharged

Part No.	Qty	Description
ERTC6000	1	12V Digital Cordless Air Compressor



SAS



S-A-S Assorted Pack - Lubricant Aerosols 500ml

A selection of our fastest moving lubricant aerosols, including the No. 1 selling Universal Maintenance Lubricant used for a multitude of lubricating and maintenance applications.

Part No.	Qty
SASL	Set of 6
6 x 500ml Aerosols: White Grease with PTFE, Clear Grease, Silicone Spray, Chain & Cable Lube, Copper Grease, Universal Maintenance Lubricant.	

SAS



S-A-S Assorted Pack - Cleaning Aerosols 500ml

A selection of popular cleaning aerosols, plus the No. 1 selling Universal Maintenance Lubricant which can be used for a wide range of everyday cleaning applications.

Part No.	Qty
SASC	Set of 6
6 x 500ml Aerosols: Brake Cleaner, Throttle Body Cleaner, Electrical Cleaner, Label & Gum Remover, Leak Detector, Universal Maintenance Lubricant.	

SAS



S-A-S Assorted Pack - Valeting Aerosols 500ml

A selection of professional quality valeting aerosols, providing a clean finish for all vehicles. Plus the No.1 selling Universal Maintenance Lubricant, ideal for everyday maintenance applications.

Part No.	Qty
SASV	Set of 6
6 x 500ml Aerosols: Glass Cleaner, Cockpit Spray, Tyre Foam, Multi Purpose Foam Cleaner, Air Duster, Universal Maintenance Lubricant.	

SAS



S-A-S Assorted Pack - Paint Aerosols 500ml

A selection of top quality paint aerosols, providing a professional finish each and every time. Plus the No. 1 selling Universal Maintenance Lubricant, ideal for everyday maintenance applications.

Part No.	Qty
SASP	Set of 6
6 x 500ml Aerosols: Zinc Spray, Satin Black Paint, Silver Paint, Grey Primer, Red Oxide Primer, Universal Maintenance Lubricant.	



238



239



242

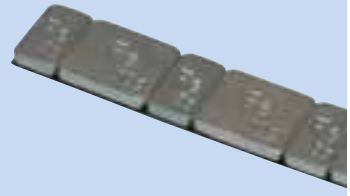

247



248



250

**Auto,
Commercial + Plant**



252



256

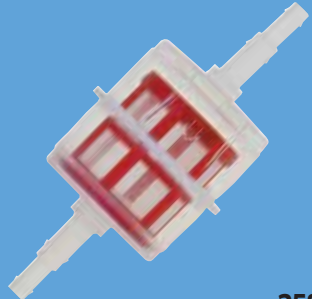

258

- 238 Wheels + Tyres
- 252 Brakes
- 258 Engine
- 266 Exhaust
- 268 Windscreen
- 270 M.o.T.
- 271 Commercial
- 272 Ratchet Straps
- 273 Lifting Slings
- 274 Trailer
- 278 Work Lamps
- 280 Rotating Beacons
- 282 Hydraulic
- 285 Plant
- 286 Concrete Remover



261



264



266



268



272



274



282



286





REMA TIP TOP Tube Patches - Red Edge, Round

Doublescalloped edge ensure perfect bonding and 100 % vulcanisation.

- Due to the stepped multi-layer structure of the patch body they stretch evenly in all directions when the tube is inflated.
- They leave no edges on the repair area.



Part No.	Box of	Size No.	Ø	Suits
TY111	30	No. 1	35 mm	Bicycles, Motorbikes, Cars
TY112	30	No. 2	45 mm	Motorbikes, Cars
TY113	30	No. 3	54 mm	Cars, Trucks, Agricultural
TY114	30	No. 4	75 mm	Cars, Trucks, Agricultural
TY115	10	No. 5	94 mm	Trucks, Agricultural
TY116	10	No. 6	116 mm	Trucks, Agricultural



REMA TIP TOP Tube Patches - Red Edge, Oval

Part No.	Box of	Size No.	Size (L x W)	Suits
TY117	10	No. 7B	150 x 75 mm	Trucks, Agricultural



REMA TIP TOP Tube Patches - Air/Water Valve

Rubber base valves. Doublescalloped edge ensure perfect bonding and 100 % vulcanisation.

- Due to the stepped multi-layer structure of the patch body they stretch evenly in all directions when the tube is inflated.
- They leave no edges on the repair area.

Part No.	Qty	Size No.	Ø
TY118	10	TR 218A	80 mm



REMA TIP TOP Tube Patches - Euro Black Edge, Round

Doublescalloped edge ensure perfect bonding and 100 % vulcanisation.

- Due to the stepped multi-layer structure of the patch body they stretch evenly in all directions when the tube is inflated.
- They leave no edges on the repair area.

Part No.	Qty	Size No.	Ø	Suits
TY101	50	Euro No. 1	35 mm	Bicycles, Motorbikes, Cars
TY102	50	Euro No. 2	45 mm	Motorbikes, Cars
TY103	50	Euro No. 3	54 mm	Cars, Truck, Agricultural
TY104	25	Euro No. 4	75 mm	Cars, Truck, Agricultural
TY105	20	Euro No. 5	94 mm	Trucks, Agricultural
TY106	20	Euro No. 6	116 mm	Trucks, Agricultural



REMA TIP TOP Tube Patches - Universal

For the repair of small injuries to tube or tubeless radial and cross-ply tyres.

Part No.	Qty	Size No.	Size	Suits
TY364	50	UP 4.5	37 x 37 mm	Cars, Trucks
TY366	50	UP 6	43 x 43 mm	Cars, Trucks
TY368	50	UP 8	55 x 55 mm	Cars, Trucks



REMA TIP TOP Tube Patches - Cross-Ply Repair Patch, Series PN

Repair patches for durable repairs to cross-ply tyres of all sizes, especially for tread, shoulder and sidewall injuries.

- Suitable for both self-vulcanising and hotvulcanising processes due to the fully integrated bonding layer. Use in conjunction with the appropriate REMA TIP TOP accelerator solutions

Part No.	Qty	Size No.	Ø / Ply	Suits
TY143	10	PN 03	100 mm / 2 Ply	Cars, Trucks
TY144	10	PN 04	120 mm / 2 Ply	Cars, Trucks
TY145	10	PN 05	160 mm / 4 Ply	Trucks
TY146	10	PN 06	235 mm / 6 Ply	Trucks



REMA TIP TOP Tube Patches - RAD Repair, Series 100

Repair patches for durable repairs to all radial tyre sizes and for all applications.

- Suitable for hot- or self-vulcanisation due to the unique bonding layer in conjunction with the appropriate REMA TIP TOP accelerator cements or solutions.

Part No.	Qty	Size No.	Size (L x W) / Ply	Suits
TY370	20	110 TL	75 x 55 mm / 1 Ply	Cars
TY371	10	116 TL	104 x 67 mm / 1 Ply	Cars, Trucks, Fork Lift
TY372	10	120 TL	125 x 80 mm / 2 Ply	Trucks
TY373	10	125 TL	125 x 115 mm / 3 Ply	Trucks
TY374	10	135 TL	180 x 130 mm / 4 Ply	Trucks, Fork Lift, EM
TY375	10	140 TL	100 x 195 mm / 3 Ply	Trucks, Fork Lift, EM
TY376	10	142 TL	130 x 260 mm / 4 Ply	Trucks, Fork Lift
TY377	10	144 TL	130 x 335 mm / 4 Ply	Trucks, EM



REMA TIP TOP Combi Plug Patches - 'Minicombi'

Combined patch/plug tyre repair for punctures to the tread of both radial and cross-ply tyres.

- Repair units vulcanise in the tyre.
- The tyre inside and the puncture channel are repaired in one operation.
- The ingress of moisture, dirt, stones or all materials that lead to premature deterioration of the casing and belts is prevented.

Part No.	Qty	Kit No.	For Tread Damage
----------	-----	---------	------------------

TY137	Box of 50	A3	Up To 3.5 mm
--------------	-----------	-----------	---------------------

Box contents: 50 x Repair units with metal pilot. 1 x Instruction manual.

TY136	Pack of 20	A6	Up To 6 mm
--------------	------------	-----------	-------------------

Pack contents: 20 x Repair units with metal pilot

TY136B	Box of 40	A6	Up To 6 mm
---------------	-----------	-----------	-------------------

Box contents: 20 x Repair units with metal pilot. 1 x Instruction manual

TY138	Box of 20	B8	Up To 8 mm
--------------	-----------	-----------	-------------------

Box contents: 20 x Repair units with metal pilot. 1 x Instruction manual.

TY139	Box of 20	B10	Up To 10 mm
--------------	-----------	------------	--------------------

Box contents: 20 x Repair units. 3 x Pull wires. 1 x Instruction manual.



BEST SELLER

REMA TIP TOP 'Cement SSV-VULC' Vulcanising Fluid

For use with tube patches.

Part No.	Qty	Size
----------	-----	------

TY132	1	25g Tube
--------------	---	-----------------

TY133	1	50g Tube
--------------	---	-----------------

TY100	1	175g Can c/w Brush
--------------	---	---------------------------



BEST SELLER

REMA TIP TOP 'SC-BL' Special Blue Cement

For use with Radial Repair Patches and Combi Plug-Patches.

Part No.	Qty	Size
----------	-----	------

TY131	1	30g Tube (35ml)
--------------	---	------------------------

TY130	1	200g Can & Brush
--------------	---	-----------------------------



Patch Stitcher

Wooden handle. Wheel diameter: 35 mm.

Part No.	Qty	Description
----------	-----	-------------

TY161	1	4 mm Patch Stitcher
--------------	---	----------------------------



REMA TIP TOP Motorcycle Tyre Repair & Inflate Kit - 'Rep & Air' Tubeless

The complete break-down service for getting you moving again. After the repair, the tyre is inflated from the cartridges within seconds. Without an air pump and loss of time. Supplied in a sturdy storage box.

- For sealing of punctures without demounting the tyre from the rim
- Includes cartridges for fast and easy inflation of the tyre after the repair
- Suitable only for temporary repair of mounted tyres

Safety Warning! The tyre should be checked/repared permanently after 400 km maximum (at a maximum speed of 60 km/h) by a tyre expert or workshop.

Part No.	Qty	Description
----------	-----	-------------

TY191	1 Kit	REP & AIR Tubeless Kit
--------------	-------	-----------------------------------

Kit contents: 3 x Super Sealastic repair plugs. 1 x Special Cement BL. 4 g tube. 1 x Inserting tool. 1 x Clasp knife. 1 x Chalk. 3 x Cartridges. 16 g each. 1 x Cartridge adapter. 1 x Cartridge freeze protector. 1 x Instruction manual.



REMA TIP TOP Tyre Repair Workshop Kit

Supplied in a sturdy storage box.

Part No.	Qty	Kit No.	Suits
----------	-----	---------	-------

TY190	1 Kit	TT 30	Truck, Tractor
--------------	-------	--------------	----------------

Kit contents: 12 x Patches Size 1. 6 x Patches Size 3. 2 x Patches Size 4. 1 x Patch Size 5. 3 x Patches Size 7. 2 x Patches Size 7B. 2 x Cross-Ply repair patch: PN 03. 1 x Tube of SVS solution: 50 g. 2 x Rasps. 1 x Rasp handle. 1 x Stitcher. 1 x Instruction manual.

MARKAL 'B Paintstik' Markers

Marks on rough, smooth, rusty or dirty surfaces

Part No.	Box of	Colour
----------	--------	--------

VC432	12	Yellow
--------------	----	---------------

VC433	12	White
--------------	----	--------------



BEST SELLER

Universal Yellow Markers

For use on metal, glass rubber, etc. Can be used on wet surfaces.

Part No.	Pack of	Type
----------	---------	------

VC430	12	Pencils
--------------	----	----------------



BEST SELLER

Universal Yellow Markers

For use on metal, glass rubber, etc. Can be used on wet surfaces.

Part No.	Pack of	Type
----------	---------	------

VC431	12	Blocks
--------------	----	---------------





REMA TIP TOP 'Sealastic' Tyre Repair Kit

Temporary nail hole repair for cross-ply truck tyres mounted on the rim (max. injury size 8 mm) as well as EM and agricultural tyres (max. injury size 15 mm). Also suitable for tubeless radial EM tyres (up to a maximum speed of 40 km/h, if the carbide mill cutter, pointed is used).

Part No.	Qty	Description
TY192	1 Kit	Tyre Repair Kit

Box contents: 10 x Repair units. 2 x Special Cement BL: 40 g cans. 1 x Insertion tool for EM. 1 x Rasp Ø 6.5 mm. 1 x Instruction manual.



REMA TIP TOP ATV/Quad Bike Repair Kit

Supplied in robust storage case.

Part No.	Qty	Description
TY197	1 Kit	ATV Repair Kit

Kit contents: 50 x Repair Strings. 1 x Hand rasp. 1 x Inserting tool. 1 x Special Cement BL: 225g tin.



REMA TIP TOP 'Sealfix' String - Long Type

For temporary repairs of tread punctures.

Part No.	Qty	Colour	Length
TY193	25	Brown	200 mm



REMA TIP TOP 'Sealfix' String - Long Type

For temporary repairs of tread punctures.

Part No.	Qty	Colour
TY194	25	Black

Insert Tool T-Handle

Chrome plated replaceable needle. Supplied with spare needle.

Part No.	Qty	Size
TY164	1	3" Blade Length



REMA TIP TOP 'Sealastic' Plugs - Refill Pack

Temporary nail hole repair for cross-ply truck tyres mounted on the rim (max. injury size 8 mm) as well as EM and agricultural tyres (max. injury size 15 mm). Also suitable for tubeless radial EM tyres (up to a maximum speed of 40 km/h, if the carbide mill cutter, pointed is used).

Part No.	Qty	Size No.	Type	Suits
TY195	20	TT 611	Truck Plugs	Trucks



REMA TIP TOP 'Sealastic' Plugs - Refill Pack

Temporary nail hole repair for cross-ply truck tyres mounted on the rim (max. injury size 8 mm) as well as EM and agricultural tyres (max. injury size 15 mm). Also suitable for tubeless radial EM tyres (up to a maximum speed of 40 km/h, if the carbide mill cutter, pointed is used).

Part No.	Qty	Size No.	Type	Suits
TY196	20	TT 612	EM Plugs	Earth Movers



REMA TIP TOP 'Sealastic' Insert Tool

Part No.	Qty	Blade Length
TY165	1	230 mm



REMA TIP TOP 'Remacure' Insert Tool - ATV

Part No.	Qty	Description
TY167	1	ATV Insert Tool

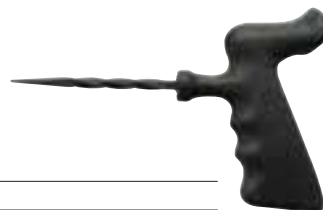

REMA TIP TOP 'Remacure' Spiral Awl

Part No.	Qty	Blade Ø x Length
TY168	1	6 mm x 4"



REMA TIP TOP 'Sealastic' Hand Rasp

Part No.	Qty	Blade Ø x Length
TY166	1	6.5 x 190 mm



Bead Sealer

Can be used on cross-ply and radial tyres. Brush in can lid.

Part No.	Qty	Size
TY310	1	946 ml Can



REMA TIP TOP 'MONT 2000' Bead Lubricant (Tyre Soap)

White. For all standard mounting application.

- Designed for car and truck tyre mounting

Part No.	Qty	Size
TY300	1	5 kg Tub



REMA TIP TOP Tyre And Tube Mounting Compound

Can be used as a "flexible pump ring" for all tyre mounting operations.

- Stiff paste with stable viscosity to seal the gap between tyre bead and rim edge

Part No.	Qty	Size
TY302	1	10 kg Bucket



REMA TIP TOP Bead Paste 'Black Tyre Paste'

Used for mounting and demounting all types and sizes of tyres.

- Black in colour - Leaves no visible residue on tyre after mounting

Part No.	Qty	Size
TY301	1	5 kg Tub



REMA TIP TOP Talcum Powder

For use with mounting tube tyres.

- Fine-grained
- Asbestos free

Part No.	Qty	Size
TY332	1	500g



REMA TIP TOP Tyre Sealant

Seals major air loss around the beads and O-rings, conditions the inner liner and maintains the air pressure after punctures, all of which help to control costly downtime.

- Seals punctures up to 3/16", prevents wheel and rim rusting and eases the detection of sealed holes to maintenance engineers.
- Offers proven protection from airloss for fleet tyres used in, Trucking, Construction, Logging, Mining, Farming, Sanitation, Lawn/Turf Care, Public Works and recreational vehicles.

Part No.	Qty	Size
TY303	1	20 Litre Drum
CAN17	1	Drum Pump



Mounting Paste Brushes

For application of bead lubricants.

Part No.	Qty	Application
TY163	1	For Cars



Mounting Paste Brushes

For application of bead lubricants.

Part No.	Qty	Application
TY162	1	For Trucks



REMA TIP TOP Liquid Buffer

Removes contaminants, silicones, talc's and other mould release agents from tubes and the tyre inner liner prior to mechanical buffing.

Part No.	Qty	Size
TY331	1	1 Litre Can
TY330	1	500g Aerosol



Buffing Stone

Golf ball type.

Part No.	Qty	Shaft Ø
TY160	1	6 mm





RING 'Tyre Repair' Emergency Puncture Repair Sealant

Single use product.

Will NOT repair tyres that have come off the rim, are ripped, have punctures larger than 5 mm or have damaged walls.

- For tyres up to and including 16"
- Provides a temporary repair designed to get you home, no need for any tools or wheel changes

Part No.	Qty	Size
RTS1	1	400ml Aerosol

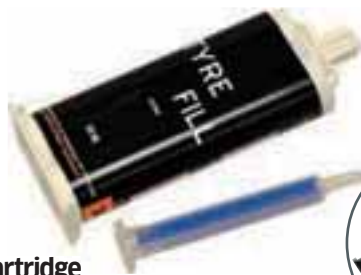

Tyre Fill Cartridge

Tyre Fill is ideal for repairs to conveyors, tyres, bumpers and other heavy duty rubbers.

- A flexible, rapid curing two part repair system.
- The product is dispensed using the true mix cartridge system to guarantee proper mixing and ease of use.

Part No.	Qty	Description
TY340	1	50ml Cartridge
VIP37	12	Applicator Nozzles
TL887	1	50ml Syringe Applicator Gun

Carbide Mill Cutter

For the precise injury preparation on radial and cross-ply tyres.

- Special profile adapted to steel cord preparation.
- Long service life.

Part No.	Qty	Ø x Length	Blade Length
TY151	1	3.0 x 60 mm	25 mm

Carbide Mill Cutter

For the precise injury preparation on radial and cross-ply tyres.

Part No.	Qty	Ø x Length	Blade Length
TY150	1	6.0 x 90 mm	40 mm

Carbide Mill Cutter

For the precise injury preparation on radial and cross-ply tyres.

Part No.	Qty	Ø x Length	Blade Length
TY153	1	8.0 x 100 mm	50 mm

Carbide Mill Cutter

For the precise injury preparation on radial and cross-ply tyres.

Part No.	Qty	Ø x Length	Blade Length
TY152	1	10.0 x 100 mm	50 mm

Tyre Valves - Snap-in Car/Van

Part No.	Qty	Rim Hole x Length	TR No.	Max Pressure
TY123	25	11.3 x 43 mm	413	4.5 bar



Tyre Valves - Snap-in Car/Van

Part No.	Qty	Rim Hole x Length	TR No.	Max Pressure
TY122	10	11.3 x 33 mm	412	4.5 bar



BEST SELLER

Tyre Valves - Snap-in Car/Van

Part No.	Pack of	Fits Hole x Length	TR No.	Max Pressure
TY126	25	11.3 x 49 mm	414	4.5 bar
TY126B	100	11.3 x 49 mm	414	4.5 bar



Tyre Valves - Snap-in Car/Van

Part No.	Pack of	Fits Hole x Length	TR No.	Max Pressure
TY127	25	11.3 x 61.5 mm	418	4.5 bar
TY127B	100	11.3 x 61.5 mm	418	4.5 bar



Tyre Valves - Snap-in 90° Scooter/Motorcycle

Tubeless valves.

Part No.	Qty	Rim Hole
TY259	10	11.5 mm

Tyre Valves - Snap-in HP Van/Transit

Part No.	Qty	Rim Hole
TY257	10	11.5 mm



Tyre Valves - Snap-in Air/Water Tractor

Tubeless valves.

Part No.	Qty	Rim Hole x Length
TY256	10	16 x 53 mm



Tyre Valve Cores - Earth Movers

Part No.	Qty	Type
TY267	10	Short



Tyre Valve Cores

Short.

Part No.	Pack of	Description
TY121	100	Tyre Valve Cores



Tyre Valves - Clamp-in Cars

Metal valve.

Part No.	Qty	Rim Hole
TY263	10	11.3 mm



Tyre Valves - Clamp-in Motorcycle

Installation torque: 7-10 Nm.

Part No.	Qty	Rim Hole x Length
TY266	10	8.3 x 33 mm



Tyre Valve Extensions - 90° Motorcycle

Metal.

Part No.	Qty	Type
TY264	5	90° Bend



Tyre Valves - Clamp-in Truck/Bus

Metal valve. Installation torque: 4-6 Nm.

Part No.	Qty	Rim Hole
TY251	10	16 mm



Tyre Valves - Clamp-in 45° Safety Hump/ EVA Truck/Bus

Metal valve. Installation torque: 13-15 Nm.

Part No.	Qty	Rim Hole
TY254	10	9.7 mm



Tyre Valves - Clamp-in Truck

Metal valve. Installation torque: 13-15 Nm.

Part No.	Qty	Rim Hole
TY253	10	9.7 mm



Tyre Valves - Clamp-in 90° Truck/Bus

Metal valve. Installation torque: 4-6 Nm.

Part No.	Qty	Rim Hole
TY252	10	16 mm



Tyre Valves - Clamp-in Air/Water Tractor

Metal valve.

Part No.	Qty	Rim Hole x Length
TY258	10	16 x 50 mm



Tyre Valves - Clamp-in 153° Truck/Bus

Nickel-plated metal valve.

For alloy rims. Installation torque: 9-14 Nm.

Part No.	Qty	Rim Hole
TY255	5	9.7 mm

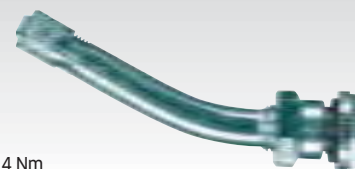

Tyre Valve Extensions - PVC Truck

Plastic.

Part No.	Qty	Size
TY245	10	115 mm
TY246	10	150 mm
TY247	10	170 mm



Tyre Valve Extensions - Rigid Type

Part No.	Pack of	Length
TY220	5	52 mm
TY221	5	76 mm
TY222	5	100 mm
TY223	5	112 mm
TY224	5	126 mm
TY225	5	160 mm



Tyre Valve Extensions - Flexible

Part No.	Pack of	Length
TY240	5	105 mm
TY241	5	180 mm
TY242	5	210 mm



**BEST
SELLER**



Tyre Valve Caps

Part No.	Pack of	Type
TY120	100	Plastic - Black
TY125	100	Plastic - Green
TY260	25	Hex Nickel High Pressure
TY262	25	Chromium Metal - Long

ALLIGATOR

ALLIGATOR Double Seal Valve Caps

Part No.	Pack of	Description
TY261	5	Double Seal Valve Caps



Valve Extension Holders

Single.

Part No.	Pack of	Description
TY250	5	Valve Holders



Valve Mounting Tool

Hold-on type.

Part No.	Qty	Description
TY291	1	Valve Mounting Tool



Valve Mounting Tool

Plastic handle for Alloy Wheels.

Part No.	Qty	Description
TY292	1	Valve Mounting Tool



Valve Core Screwdrivers

Part No.	Pack of	Description
TY290	5	Valve Core Screwdrivers



**BEST
SELLER**

Tyre Lever - HALTE

For use with tubeless truck tyres.

Part No.	Qty	Length
TY178	1	800 mm



Tyre And Mouting Lever - TTL1

Part No.	Qty	Length
TY180	1	34"



Tyre And Mouting Lever - TTL55

Part No.	Qty	Length
TY179	1	15.25"



Inner Liner Scraper Tool

• Especially suitable for profiled inner liners.

Part No.	Qty	Description
TY169	1	Tyre Scraper



Bead Breaker - Commercial

Overall length Closed: 38" Open: 62".

Part No.	Qty	Description
TY175	1	Commercial Bead Knocker



Hand Bead Breaker - BBO Long

Chisel type bead breaker with plastic grip handle.

Part No.	Qty	Type
TY176	1	BBO Long



Hand Bead Breaker - BBO Short

Chisel type bead breaker with plastic grip handle.

Part No.	Qty	Type
TY177	1	BBO Short



Bead Breaker - EVA/EVH Tyres

Developed specifically to displace the tyre bead on EVA, EVH, Actros and other commercial vehicle wheels which have an internal rib. It can also be used to displace the tyres on all commercial wheels to which it may be correctly fitted by trained tyre fitters.

- Can be used with an air wrench or hand spanner to give over five tons of force. Even the toughest tyre can be displaced quickly and easily.

* Please allow 5-7 days delivery on this product.

Part No.	Qty	Suits
TY172*	1	EVA/EVH Tyres





Combi Tyre Bead Breaking Kit

Breaker weight: 15.5 kg. Pump weight: 10.4 kg.
Breaking force: 11 tonne.
Max operating pressure: 700 bar.

- For wheels up to 29"

* Please allow 5-7 days delivery on this product.

Part No.	Qty	Suits
TY173*	1 Kit	Bead Breaking Kit

Kit contains:

1 x Combi Bead Breaker, 1 x Air Hydraulic Pump with Steel Reservoir, 5 QT. 1 x 8ft Hydraulic Hose with coupler.



'Bead Bazooka'™ Bead Setter

Gaither's revolutionary 'Bead Bazooka'™ combines the unique rapid air release technology and easiest-to-handle tank for seating tubeless tyre beads. Simply fill the tank, aim the redesigned Double Barrel, and FIRE!!

- The instantaneous blast of air from the 9 litre tank will work on motorbikes, cars, trucks, ATV and small AG tyres
- Most powerful automatic release system available in any bead-seating device
- Light weight (9.5kg) reduces stress on technician
- Push-button trigger allows technician to keep both hands on the tank for more control, making safer than manual release tanks
- Fully TÜV, CE & ASME certified.

* Please allow 5-7 days delivery on this product.

Part No.	Qty	Size
TY1200*	1	9 Litre Tank



REMA TIP TOP Truck Tyre Filler

Tank capacity: 18 Litres. 10 bar.

- Light in weight.
- Can be used to inflate truck tyres in both a horizontal or vertical position.

* Please allow 5-7 days delivery on this product.

Part No.	Qty	Description
TY1201*	1	Truck Tyre Filler



REMA TIP TOP Regrooving Blades - Angle Blades

Wide blades.

For use with 'Rubber Cut 400/414' and tyre cutters.

- Blades have one extended side for easier and safer location of the blade into the blade holder.

Part No.	Pack of	Type	Cut Width	Cut Depth
TY402	20	W Fix 2	5 - 6 mm	Max 8 mm
TY403	20	W Fix 3	6 - 8 mm	Max 10 mm
TY404	20	W Fix 4	9 - 10 mm	Max 14 mm
TY405	20	W Fix 5	10 - 14 mm	Max 16 mm



REMA TIP TOP Regrooving Blades - Round Blades

Wide blades. For use with 'Rubber Cut 400/414' and tyre cutters.

- Blades have one extended side for easier and safer location of the blade into the blade holder.

Part No.	Pack of	Size No.	Cut Width	Cut Depth
TY412	20	R Fix 2	5 - 6 mm	Max 8 mm
TY413	20	R Fix 3	6 - 8 mm	Max 10 mm
TY414	20	R Fix 4	9 - 10 mm	Max 14 mm
TY415	20	R Fix 5	10 - 14 mm	Max 16 mm



REMA TIP TOP 'Rubber Cut 414' Regroover

Allows fast and accurate regrooving of the tread.

8-step temperature switch for different cutting speeds.

Blades **NOT** included.

- Ergonomic handle design makes working easier
- Insulated cutting head.
- Greater freedom of movement and easy guiding thanks to separation of handle and transformer.
- Cutting width with FIX regrooving blades 3 - 28 mm.
- Prepared for wall mounting.
- Lockable carrying handle.
- Automatic overheating cutout according to DIN 30600.
- GS-tested, meets recognized safety standards.

Part No.	Qty	Voltage
TY601	1	110 V
TY602	1	240 V





OE Quality Adhesive Wheel Weights - Steel

Supplied on a dispenser spool.

Part No.	Roll of	Description
TW500	1,200	5g Adhesive Weights



Wheel Balancing Weight Pliers

For mounting, removing and relocating wheel balance weights on the rim. For expanding and compressing of clips, heavy duty jaw for cutting wheel weights.

Part No.	Qty	Length
TL254	1	240 mm (9 1/2")



KS TOOLS Wheel Balancing Weight Pliers

Special tool steel, drop-forged, oil hardened. For fixing, moving and loosening wheel balancing weights. Heavy duty jaw for cutting wheel weights.

Part No.	Qty	Length
K150.2024	1	240 mm (9 1/2")



Wheel Weight Adhesive Removing Tool

Part No.	Qty	Description
TY170	1	Adhesive Removing Tool



OE Quality Adhesive Wheel Weights - Steel

General use.

Part No.	Qty	Weight
TW560	Pack of 25	60g Strips
TW600	Box of 100	60g Strips

Strip Weights: 5g (x4), 10g (x 4).



OE Quality Wheel Weights - Zinc

For standard steel wheels.

Part No.	Pack of	Weight
TW105	100	5g
TW110	100	10g
TW115	100	15g
TW120	100	20g
TW125	100	25g
TW130	100	30g
TW135	50	35g
TW140	50	40g



OE Quality Wheel Weights - Zinc. Plastic Coated for Alloy Wheels

Plastic Coated to OE standards. Designed to fit most European cars with rim horns 4.5/6.5mm thick.

Part No.	Qty	Weight
TW405	100	5g
TW410	100	10g
TW415	100	15g
TW420	100	20g
TW425	100	25g
TW430	100	30g
TW435	50	35g
TW440	50	40g





Tyre Bath

- For identifying the location of punctures or bead leaks in car tyres or inner tubes
- * Please allow 5-7 days delivery on this product.

Part No.	Qty	Description
TY1101*	1	Tyre Bath



Static Safety Cage - 4x4/Light Van

Mesh type. Fabricated from RHS steel structure the Static Safety Cage provides protection for the operator whilst inflating larger tyres in the event of the tyre exploding due to over inflation.

- A necessity in the workshop to comply with Health & Safety Executive legislation
- * Please allow 5-7 days delivery on this product.

Part No.	Qty	Description	Dimensions
TY1100*	1	Static Safety Cage	36" x 36" x 24"



Wheel Chock - Commercial

Dimensions (L x H x W): 210 x 230 x 160 mm.

Part No.	Qty	Description
TY174	1	Wheel Chock



COMPAC Hydraulic Trolley Jack

- Low entry height
- Lift and turn lowering system prevents unintentional lowering
- Additional foot pedal pumping feature provides fast saddle raising to the load
- Pressure relief valve prevents overloading
- Safety lowering control valve for safe lowering even under load
- * Please allow 5-7 days delivery on this product.

Part No.	Qty	Lifting Capacity	Lifting Height	Chassis Length
TY1020*	1	2 Tonnes	500 mm	720 mm



COMPAC Axle Stands - Low Entry Screw Type

Weight: 11.8 kg each. Fully welded structure in high quality steel. Solid pillars. Solid spindles.

- Fitted with base plates to ensure even distribution of the load
- Designed specifically for Low-Entry applications

Part No.	Qty	Capacity (Per Pair)	Max Height	Min Height
TY1011	Set of 2	24 Tonnes	500 mm	340 mm



OMEGA Axle Stands - Low Entry

Dimensions: (L x W x H): 208 x 108 x 284 mm.

- Fitted with base plates to ensure even distribution of the load

Part No.	Qty	Capacity (Per Pair)	Max Height	Min Height
TY1014	Set of 2	2.8 Tonnes	450 mm	305 mm



SELSON Air Jack Bellows - 2 Bag Type

Complete with extensions.
Working pressure: 100 psi.

- Fast and friendly
- Designed for stability
- Overload safety valve
- Only one airline required



Part No.	Qty	Lifting Capacity	Lifting Height	Min Height
TY1000	1	2.5 Tonnes	340 mm	130 mm

OMEGA LIFT

OMEGA Extra Low Bottle Jack - Hydraulic

Weight: 9.4 kg.



Part No.	Qty	Capacity	Max Height	Min Height
TY1005	1	20 Tonnes	285 mm	165 mm

OMEGA LIFT

OMEGA Bottle Jack - Air/Hydraulic

Weight: 39 lbs.



Part No.	Qty	Capacity	Max Height	Min Height
TY1002	1	20 Tonnes	18 1/4"	9 1/2"

OMEGA LIFT

OMEGA Bottle Jack - Hydraulic

Weight: 12.5 kg. Fabricated from hard-cast steel with heat-treated critical stress areas.

- Hydraulic system is protected from internal damage by a patented by-pass mechanism
- Machined and polished cylinders with die-cut threads provide non-abrasive leak-free, durable performance



Part No.	Qty	Capacity	Max Height	Min Height
TY1006	1	20 Tonnes	475 mm	242 mm



WINNTEC Low Bottle Jack - Air/Hydraulic

Weight: 10 kg.

Part No.	Qty	Capacity	Max Height	Min Height
TY1003	1	20 Tonnes	261 mm	146 mm

MEGA

MEGA Bottle Jack - Air/Hydraulic

Supplied with hose and trigger.
Operating pressure: 7 bar/100 psi.
Weight: 15.5 kg.

- Can also be operated manually as an alternative to the normal air/hydraulic using the pump and supplied pump handle
- Heavy duty saddle
- Integrated carrying handle

Part No.	Qty	Lifting Capacity	Max Height	Min Height
TY1001	1	20 Ton	447 mm	234 mm

MEGA

MEGA Bottle Jack - Hydraulic

Weight: 14.5 kg. High quality lifting jacks manufactured to meet rigid safety and quality standards. Supplied with pump handle.

- Heavy duty saddle
- Integrated carrying handle

Part No.	Qty	Capacity	Max Height	Min Height
TY1004	1	30 Ton	467 mm	242 mm





BAILCAST

**BAILCAST 'Maxiboot'
Universal CV Boot Kit**

Complete with 2 x stainless steel clamps, 60g sachet of MoS2 CV grease and instructions. Shaft Ø: 28-40 mm. Join Ø: 76-120 mm.

• For large CV joints and drive shafts.

Part No.	Qty	Description
CVB88	1 Kit	CV Boot Kit



BAILCAST

**BAILCAST 'Uniboot'
Stretchy Drive Shaft Boot Kit**

Complete with 2 x stainless steel clamps, 60g sachet of MoS2 CV grease and instructions. Shaft Ø: 19-28 mm. Join Ø: 56-110 mm.

Part No.	Qty	Description
CVB96	1 Kit	Drive Shaft Boot Kit
CVB96B	12 Kits	Drive Shaft Boot Kits



**CV Boot
Clamp Pliers**

Part No.	Qty	Description
TL928	1	CV Boot Clamp Pliers



**CV Boot
Metal Clamps**

Stainless steel.

Part No.	Pack of	Size	Range
HCV1	20	Small	19 - 40 mm
HCV2	20	Large	50 - 110 mm



BAILCAST

BAILCAST CV Boot Fitting Cone

Fits CV joints of up to 95 mm. Stretch the CV Boots over the fitting cone using the Rubber Care lubricant. No dismantling of the CV joint is required!

Part No.	Qty	Description
TL992	1	Fitting Cone



BAILCAST

**BAILCAST 'Duragon'
Pneumatic Fitting Tool**

Time-saving tool made for stretching CV boots over CV joints without dismantling the joint. Standard air line fitting.

Part No.	Qty	Description
TL994	1	Pneumatic Fitting Tool



SAS

S-A-S Rubber Care

Maintains rubber seals on doors, bonnets, tailgates, etc. Can be used on tyres, rubber mats and rubber trim strips.

- Suitable for use with CV Boot Fitting Cone (Part No. TL992).
- Reduces the effect of spray and salt water
- Reduces the effects of diluted acids and alkalines
- Prevents rubber parts ageing and cracking and eliminates squealing noises from dry rubber
- Silicone FREE

Part No.	Pack of	Size
SAS57	6	500ml Aerosols





Dust Cover for Ball Joints

Black rubber. Complete with rubber O-rings.

Part No.	Pack of	Small Hole Ø	Large Hole Ø	Height
DC1	10	10.5 mm	25 mm	23 mm



Dust Cover for Ball Joints

Black rubber. Complete with rubber O-rings.

Part No.	Pack of	Small Hole Ø	Large Hole Ø	Height
DC4	10	15 mm	30 mm	25 mm



Dust Cover for Ball Joints

Black rubber. Complete with rubber O-rings.

Part No.	Pack of	Small Hole Ø	Large Hole Ø	Height
DC2	10	12 mm	28 mm	26.5 mm



Dust Cover for Ball Joints

Black rubber. Complete with rubber O-rings.

Part No.	Pack of	Small Hole Ø	Large Hole Ø	Height
DC5	10	18.5 mm	28.6 mm	15.5 mm



Dust Cover for Ball Joints

Black rubber. Complete with rubber O-rings.

Part No.	Pack of	Small Hole Ø	Large Hole Ø	Height
DC3	10	13 mm	35.5 mm	30 mm



Dust Cover for Ball Joints

Black rubber. Complete with rubber O-rings.

Part No.	Pack of	Small Hole Ø	Large Hole Ø	Height
DC6	10	18 mm	40.5 mm	37 mm

Assorted Box of Dust Covers for Vehicle Ball Joints

Black rubber. Complete with rubber O-rings.

Part No.	Box of
AB220	10 Kits
2 x Each Kit: DC1, DC2, DC3, DC4, DC5.	



Brake Nuts Male - Metric



Length: 19.5 mm. Internal Ø: 3.8 mm

Part No.	Pack of	Ø x Pitch
BN161	25	M8 x 1.25 mm

Suits: Citroën



Length 22.8 mm

Part No.	Pack of	Ø x Pitch
BN12	50	M10 x 1.00 mm

Suits: Honda, Kia, Suzuki, Toyota, Volvo, VW



Length 19.6 mm

Part No.	Pack of	Ø x Pitch
BN16	50	M10 x 1.25 mm

Suits: Audi, Ford, Peugeot, Saab, Seat, Volvo, VW



Length: 20.8 mm. Internal Ø4.8 mm

Part No.	Pack of	Ø x Pitch
BN162	25	M9 x 1.25 mm

Suits: Citroën



Length 23 mm

Part No.	Pack of	Ø x Pitch
BN170	25	M10 x 1.00 mm

Suits: Honda, Kia, Suzuki, Toyota, Volvo, VW

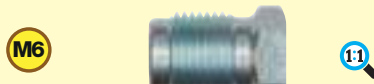

Length 18 mm

Part No.	Pack of	Ø x Pitch
BN183	25	M12 x 1.00 mm

Suits: Audi, Ford, Peugeot, Saab, Seat, Volvo, VW



Length: 16.5 mm

Part No.	Pack of	Ø x Pitch
BN11	50	M10 x 1.00 mm

Suits: Kia, Nissan, Suzuki, Toyota



Length 24 mm

Part No.	Pack of	Ø x Pitch
BN176	50	M10 x 1.00 mm

Suits: Kia, Nissan, Suzuki, Toyota



Length 20 mm

Part No.	Pack of	Ø x Pitch
BN17	50	M12 x 1.00 mm

Suits: Audi, Ford, Peugeot, Saab, Seat, Volvo, VW



Length: 16.7 mm

Part No.	Pack of	Ø x Pitch
BN167	10	M10 x 1.00 mm

Suits: Alfa Romeo, Audi, BMW, Chevrolet, Citroën, Dacia, Fiat, Ford, Honda, Hyundai, Kia, Mitsubishi, Mercedes, Nissan, Opel, Peugeot, Renault, Rover, Saab, Seat, Skoda, Suzuki, Toyota, Volvo, VW



Length 25 mm

Part No.	Pack of	Ø x Pitch
BN168	25	M10 x 1.00 mm

Suits: Hyundai



Length 24 mm

Part No.	Pack of	Ø x Pitch
BN184	25	M12 x 1.00 mm

Suits: Alfa Romeo, Citroën, Fiat, Mazda, Peugeot



Length: 16.7 mm

Part No.	Pack of	Ø x Pitch
BN169	25	M10 x 1.00 mm

Suits: Chevrolet, Daihatsu, Daewoo, Hyundai, Kia, Nissan, Opel, Skoda, Toyota, Vauxhall, VW



Length 18 mm

Part No.	Pack of	Ø x Pitch
BN13	50	M10 x 1.00 mm

Suits: Honda, Kia, Suzuki, Toyota, Volvo, VW



Length 19.5 mm

Part No.	Pack of	Ø x Pitch
BN190	25	M12 x 1.25 mm

Suits: Iveco



Length: 18 mm

Part No.	Pack of	Ø x Pitch
BN175	50	M10 x 1.00 mm

Suits: Alfa Romeo, Citroën, Fiat, Mazda, Peugeot



Length 13.5 mm

Part No.	Pack of	Ø x Pitch
BN14	50	M10 x 1.25 mm

Suits: Honda, Kia, Suzuki, Toyota, Volvo, VW



Length 18 mm

Part No.	Pack of	Ø x Pitch
BN185	25	M12 x 1.00 mm

Suits: Alfa Romeo, Citroën, Fiat, Mazda, Peugeot



Length: 21.5 mm

Part No.	Pack of	Ø x Pitch
BN21	50	M10 x 1.00 mm

Suits: Alfa Romeo, Citroën, Fiat, Mazda, Peugeot



Length 19 mm

Part No.	Pack of	Ø x Pitch
BN15	50	M10 x 1.25 mm

Suits: Honda, Kia, Suzuki, Toyota, Volvo, VW



Length 19.4 mm

Part No.	Pack of	Ø x Pitch
BN189	25	M12 x 1.25 mm

Suits: Eastern European, Fiat 238



5/16"



1:1

Length 16.5 mm

Part No.	Pack of	Ø x Pitch
BN193	25	M14 x 1.00 mm

Suits: Audi, BMW, MAN, Mercedes, VW For double flaring

5/16"



1:1

Length 16.5 mm

Part No.	Pack of	Ø x Pitch
BN192	25	M14 x 1.00 mm

Suits: Audi, BMW, MAN, Mercedes, VW For single flaring

5/16"

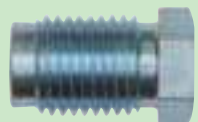

1:1

Length 25 mm

Part No.	Pack of	Ø x Pitch
BN195	50	M14 x 1.5 mm

Suits: Audi, BMW, MAN, Mercedes, VW For double flaring

5/16"



1:1

Length 25.5 mm

Part No.	Pack of	Ø x Pitch
BN194	25	M14 x 1.5 mm

Suits: Audi, BMW, MAN, Mercedes, VW For single flaring

3/8"



1:1

Length 26.5 mm

Part No.	Pack of	Ø x Pitch
BN197	25	M16 x 1.5 mm

Suits: Audi, BMW, MAN, Mercedes, VW

Brake Nuts Male - Imperial

3/16"



1:1

Length 14.4 mm

Part No.	Pack of	Ø x Pitch
BN105	50	3/8" x 24 UNF

Suits: Volvo and US cars

3/16"

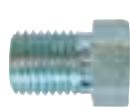

1:1

Length 16 mm

Part No.	Pack of	Ø x TPI
BN2	50	3/8" UNF x 24 TPI

3/16"



1:1

BEST SELLER

Length 20.5 mm

Part No.	Pack of	Ø x Length
BN1	50	3/8" UNF x 24 TPI

3/16"



1:1

Length 21 mm

Part No.	Pack of	Ø x Pitch
BN103	50	3/8" x 24 UNF

Suits: Renault, Saab, Vauxhall, Volvo

3/16"

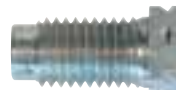

1:1

Length 23.5 mm

Part No.	Pack of	Ø x TPI
BN3	50	3/8" BSF x 20 TPI

3/16"



1:1

Length 23.4 mm

Part No.	Pack of	Ø x Pitch
BN104	50	3/8" x 20 UNF

Suits: Rover

3/16"



1:1

Length 21 mm

Part No.	Pack of	Ø x Pitch
BN111	50	7/16" x 24 UNF

Suits: British and US cars with 1/4" tubes

3/16"



1:1

Length 21.5 mm

Part No.	Pack of	Ø x Pitch
BN115	50	7/16" x 20 UNF

Suits: Renault, Rover, Talbot

1/4"



1:1

Length 15.5 mm

Part No.	Pack of	Ø x Pitch
BN110	50	7/16" x 24 UNF

Suits: British and US cars with 1/4" tubes

1/4"



1:1

Length 17 mm

Part No.	Pack of	Ø x Pitch
BN114	25	1/2" x 20 UNF

1/4"



1:1

Length 23 mm

Part No.	Pack of	Ø x Pitch
BN117	25	7/16" x 20 UNF

Suits: Peugeot

1/4"



1:1

Length 22.7 mm

Part No.	Pack of	Ø x Pitch
BN109	50	7/16" x 24 UNF

Suits: Peugeot with 1/4" Tubes

5/16"



1:1

Length 15.8 mm

Part No.	Pack of	Ø x Pitch
BN112	50	1/2" x 20 UNF

Suits: Peugeot

3/8"



1:1

Length 16.5 mm

Part No.	Pack of	Ø x Pitch
BN118	25	5/8" x 18 UNF



Brake Nuts Female - Metric



Length 15 mm

Part No.	Pack of	Ø x Pitch
BN171	25	M10 x 1.00 mm

Suits: Opel, Volvo



Length 15.5 mm

Part No.	Pack of	Ø x Pitch
BN46	50	M10 x 1.00 mm



Length 23 mm

Part No.	Pack of	Ø x Pitch
BN172	25	M10 x 1.00 mm

Suits: Alfa Romeo, Citroen, Fiat, Mazda, Mercedes, Nissan, Opel, Seat



Length 21.5 mm

Part No.	Pack of	Ø x Pitch
BN186	25	M12 x 1.00 mm

Suits: Citroën, Ford, Peugeot, Seat, VW

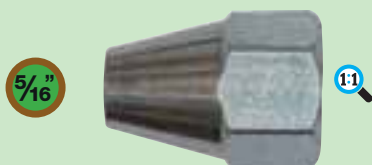

Length 29 mm

Part No.	Pack of	Ø x Pitch
BN196	25	M14 x 1.5 mm



Length 25.5 mm

Part No.	Pack of	Ø x Pitch
BN198	25	M16 x 1.5 mm

Brake Nuts Female - Imperial



Length 16 mm

Part No.	Pack of	Ø x Pitch
BN106	50	3/8" x 24 UNF

Suits: Volvo



Length 16 mm

Part No.	Pack of	Ø x TPI
BN42	50	3/8" UNF x 24 TPI



Length 17.5 mm

Part No.	Pack of	Ø x TPI
BN41	50	3/8" UNF x 24 TPI

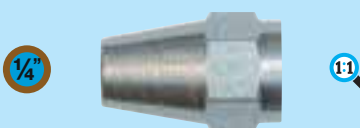

Length 24 mm

Part No.	Pack of	Ø x Pitch
BN116	25	7/16" x 20 UNF

Suits: Bedford with 1/4" Tubes



Assorted Box of Brake Nuts

For 3/16" pipe.

Part No.	Box of
AB45N	150 Pieces

2 x Brake Nuts, Short Males: 3/8" UNF x 24 TPI, 10 x 1.00 mm.

2 x Brake Nuts, Long Males: 3/8" UNF x 24 TPI, 10 x 1.00 mm.

1 x Brake Nuts, Fully Threaded Males: 10 x 1.00 mm.

1 x Part Threaded Males: 12 x 1.00 mm.

1 x Long Females: 3/8" UNF x 24 TPI.

1 x Short Females: 10 x 1.00 mm.

1 x Female Connector: M10 x 1.00mm.

3 Way Connectors - Metric



Length x Width: 35 x 35 mm. Internal Ø: 3.1 mm

Part No.	Pack of	Ø x Pitch
BN67	3	M10 x 1.00 mm



Length x Width 29.8 x 29.8 mm

Part No.	Pack of	Ø x Pitch
BN181	2	M10 x 1.00 x 3.00 mm



Length x Width 41 x 36 mm

Part No.	Pack of	Ø x Pitch
BN191	2	M12 x 1.00 x 3.00 mm

4 Way Connectors - Metric



Length x Width 41 x 41 mm

Part No.	Pack of	Ø x Pitch
BN182	2	M10 x 1.00 x 4.00 mm



3 Way Connectors - Imperial



Length x Width: 35 x 35 mm. Internal Ø: 3.1 mm

Part No. Pack of Ø x TPI

BN63 3 **3/8" UNF x 24 TPI**

Male Connector - Metric



Length: 26.5 mm. Internal Ø: 3.2 mm

Part No. Pack of Ø x Pitch

BN62 25 **M10 x 1.00 mm**

Male Connector - Imperial



Length: 28 mm. Internal Ø: 3.2 mm

Part No. Pack of Ø x Pitch

BN107 50 **3/8" x 24 UNF**



Assorted Box of Brake Tubing Connectors & Brake Bleed Screws - UNF & Metric For 3/16" pipe.

Part No. Box of

AB85N 63 Pieces

1 x Male Connector: 10 x 1.00 mm.
2 x Female Connectors: 3/8" UNF x 24 TPI, 10 x 1.00 mm.
2 x 3-way Connectors: 3/8" UNF x 24 TPI, 10 x 1.00 mm.
5 x Brake Bleed Screws: 1/4" UNF x 28 TPI, 3/8" UNF x 24 TPI, M7 x 1.00 mm, M8 x 1.25 mm, M10 x 1.00 mm.

Female Connectors - Imperial



Length: 32 mm

Part No. Pack of Ø x TPI

BN65 25 **3/8" UNF x 24 TPI**

Connectors Female - Metric



Length: 24 mm. Internal Ø: 3.5 mm

Part No. Pack of Ø x Pitch

BN174 25 **M10 x 1.00 mm**



Length: 24 mm. Internal Ø: 3.5 mm

Part No. Pack of Ø x Pitch

BN66 25 **M10 x 1.00 mm**

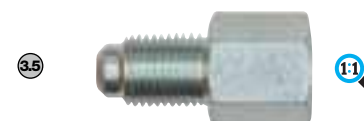

Length: 29 mm. Internal Ø: 3.5 mm

Part No. Pack of Ø x Pitch

BN173 10 **M10 x 1.00 mm**



Length: 29 mm

Part No. Pack of Ø x Pitch

BN187 10 **M12 x 1.00 mm**

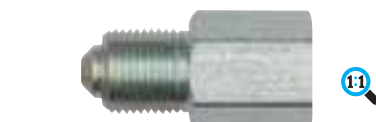

Length: 32 mm

Part No. Pack of Ø x Pitch

BN188 10 **M12 x 1.00 mm**



Brake Pipe - Seamless Cupro-Nickel

90/10 Cupro-Nickel (CuNi). 22 Gauge. Conforms to BS EN 12449 CW352H.

- Seamless tubes offering better resistance to corrosion and splitting.
- Coils are eddy current tested to ensure freedom from defects.

Part No.	Length	O.D.	Max. Work Pressure
BP3	25 ft Coil	3/16"	215 bar (3120 PSI)
BP4	25 ft Coil	1/4"	155 bar (2250 PSI)
BP5	25 ft Coil	5/16"	120 bar (1740 PSI)
BP6	25 ft Coil	3/8"	100 bar (1450 PSI)



Copper Tubing

22 Gauge. BS EN 12449 C106 soft coil. Maximum working pressure: 200 bar (3,000 PSI)

Part No.	Length	O.D.	Max. Work Pressure
CP11	25 ft Coil	3/16"	200 bar (3000 PSI)



Brake Tubing - Copper

20 Gauge. BS EN 12449 C106 soft coil. Maximum working pressure: 210 bar (3050 PSI)

Part No.	Length	O.D.	Max. Work Pressure
BP11	25 ft Coil	3/16"	210 bar (3050 PSI)



Bleed Screws Male - Metric



Length 29 mm

Part No.	Pack of	Ø x Pitch
BN85	25	M6 x 1.00 mm

Suits: Audi, BMW, Fiat, Mercedes, Opel, Saab, Seat, VW



Length 38 mm

Part No.	Pack of	Ø x Pitch
BN86	25	M6 x 1.00 mm

Suits: Audi, Seat, Skoda, Subaru, VW



Length 26.2 mm

Part No.	Pack of	Ø x Pitch
BN81	25	M7 x 1.00 mm

Suits: Citroën, Fiat, Ford, Mercedes, Nissan, Opel, Peugeot, Renault, Smart, Suzuki, Volvo



Length 28.6 mm

Part No.	Pack of	Ø x Pitch
BN150	25	M7 x 1.00 mm

Brake System: Aisin, Akebono, AP Lockheed, ATE, Bendix, Bosch, NBK, TRW

Suits: Alfa Romeo, Austin, Citroën, Fiat, Ford, Lancia, Mazda, MG, Mitsubishi, Nissan, Peugeot, Renault, Rover, Seat, Skoda, Suzuki, Talbot, Toyota, Volvo



Length 30.5 mm

Part No.	Pack of	Ø x Pitch
BN151	25	M7 x 1.00 mm

Brake System: Advics, Aisin, Akebono, AP Lockheed, ATE, Bendix, Bosch, Kelsey Hayes, Nabco, NBK, Nissan, Sumitomo, Toyota, TRW, VAG

Suits: Alfa Romeo, Audi, BMW, Citroën, Dacia, Daihatsu, Fiat, Ford, Honda, Infiniti, Jaguar, Lancia, Land Rover, Lexus, Mazda, Mercedes, Mitsubishi, Nissan, Peugeot, Renault, Rover, Saab, Seat, Skoda, Subaru, Suzuki, Talbot, Toyota, Vauxhall, Volvo, VW



Length 33 mm

Part No.	Pack of	Ø x Pitch
BN153	25	M7 x 1.00 mm

Brake System: Aisin, Akebono, AP Lockheed, ATE, Bosch, Brembo, Sumitomo, Tokico, TRW, Ukendt, ZF

Suits: BMW, Citroën, Daihatsu, Fiat, Hyundai, Infiniti, Isuzu, Lancia, Lexus, Mazda, Mercedes, Mitsubishi, Nissan, Opel, Peugeot, Renault, Saab, Subaru, Suzuki, Toyota, Vauxhall



Length 38.3 mm

Part No.	Pack of	Ø x Pitch
BN152	25	M7 x 1.00 mm

Brake System: Akebono, ATE, Citroën, Sumitomo, TRW, VAG, ZF

Suits: Alfa Romeo, Audi, BMW, Citroën, Dacia, Daihatsu, Ford, Mazda, Opel, Peugeot, Renault, Saab, Seat, Skoda, Subaru, Talbot, Toyota, Vauxhall, Volvo, VW



Length 28 mm

Part No.	Pack of	Ø x Pitch
BN156	25	M8 x 1.00 mm

Brake System: Akebono, ATE, Mando, Sumitomo, Tokico

Suits: Hyundai, Kia, Mazda, Mitsubishi, Suzuki



Length 32 mm

Part No.	Pack of	Ø x Pitch
BN154	25	M8 x 1.00 mm

Brake System: Akebono, Sumitomo

Suits: Ford, Kia, Mazda



Length 33.5 mm

Part No.	Pack of	Ø x Pitch
BN155	25	M8 x 1.00 mm

Brake System: Akebono, ATE, Delco Moraine, Kelsey Hayes, Sumitomo, TRW

Suits: Kia, Mazda, Mercedes, Opel, Saab, Suzuki, Toyota



Length 24.5 mm

Part No.	Pack of	Ø x Pitch
BN82	25	M8 x 1.25 mm

Suits: Alfa Romeo, Autobianchi, Citroën, Daewoo, Fiat, Ford, Honda, Jaguar, Kia, Lada, Lancia, Mazda, Mercedes, Mitsubishi, Nissan, Opel, Peugeot, Polmo, Renault, Rover, Saab, Seat, Talbot, Toyota, Vanden-Plas, Vauxhall, Wartburg, Zastava



Length 32.5 mm

Part No.	Pack of	Ø x Pitch
BN159	25	M8 x 1.25 mm

Brake System: Akebono, ATE, Bendix, Bosch, Brembo, Dunlop, Opel, Sumitomo, TRW

Suits: Abarth, Alfa Romeo, Audi, BMW, Chevrolet, Citroën, Dacia, Daewoo, Fiat, Ford, Honda, Land Rover, Mazda, Mercedes, Mini, Nissan, Opel, Peugeot, Renault, Rover, Saab, Seat, Skoda, Toyota, Vauxhall, Volvo



Length 34.7 mm

Part No.	Pack of	Ø x Pitch
BN160	25	M8 x 1.25 mm

Brake System: Citroën

Suits: Citroën



Length 35.5 mm

Part No.	Pack of	Ø x Pitch
BN158	25	M8 x 1.25 mm

Brake System: Akebono, ATE, Bendix, Brembo, DAC, Dunlop, Opel, TRW

Suits: Chevrolet, Chrysler, Citroën, Daewoo, Ford, Honda, Mercedes, Mini, Opel, Renault, Saab, Skoda, Suzuki, Vauxhall, Volvo



Length 41.5 mm

Part No.	Pack of	Ø x Pitch
BN157	25	M8 x 1.25 mm

Brake System: ATE, TRW

Suits: Citroën, Fiat, Lancia, Mercedes, Opel, Peugeot, Porsche, Seat, Skoda, Smart, Vauxhall, Volvo, VW



Length 30 mm

Part No.	Pack of	Ø x Pitch
BN84	25	M10 x 1.00 mm

Suits: Alfa Romeo, Audi, Austin, BMW, Chevrolet, Chrysler, Citroën, Daewoo, Daihatsu, Dodge, Fiat, Ford, Honda, Hyundai, Iveco, Jaguar, Kia, Land Rover, Mazda, Mercedes, Mitsubishi, Nissan, Opel, Peugeot, Renault, Rover, Saab, Seat, Skoda, Ssangyong, Subaru, Suzuki, Toyota, Vauxhall, Volvo, VW



Length 32 mm

Part No.	Pack of	Ø x Pitch
BN163	25	M10 x 1.00 mm

Brake System: Akebono, Mando, Sumitomo, TRW

Suits: Chevrolet, Hyundai, Kia, Opel, Vauxhall



Length 36 mm

Part No.	Pack of	Ø x Pitch
BN165	25	M10 x 1.00 mm

Brake System: Advics, Akebono, ATE, Bosch, Daewoo, Kelsey Hayes, Mando, Nissan, Opel, Sumitomo, TRW, VAG

Suits: Alfa Romeo, Audi, BMW, Chevrolet, Chrysler, Citroën, Daewoo, Dodge, Fiat, Ford, Honda, Hyundai, Jeep, Kia, Lancia, Land Rover, Mazda, Mercedes, MG, Mini, Mitsubishi, Nissan, Opel, Peugeot, Rover, Seat, Skoda, Ssangyong, Subaru, Suzuki, Toyota, Volvo, VW

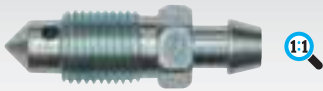

Length 34 mm

Part No.	Pack of	Ø x Pitch
BN164	25	M10 x 1.00 mm

Brake System: Advics, Aisin, Akebono, AP Lockheed, ATE, Bendix, Brembo, DAC, Mando, Nissan, Sumitomo, Tokico, TRW

Suits: Alfa Romeo, Audi, BMW, Chevrolet, Citroën, Daewoo, Daihatsu, Ford, Honda, Hyundai, Infiniti, Isuzu, Jeep, Lancia, Land Rover, Mazda, Mercedes, Mini, Mitsubishi, Nissan, Opel, Peugeot, Renault, Rover, Subaru, Suzuki, Toyota, Vauxhall, VW



Length 42 mm

Part No.	Pack of	Ø x Pitch
BN166	25	M10 x 1.00 mm

Brake System: ATE, TRW

Suits: Mercedes



Length 33 mm

Part No.	Pack of	Ø x Pitch
BN178	25	M10 x 1.25 mm

Brake System: Akebono, Nissin, Sumitomo, TRW

Suits: Honda, MG, Rover, Suzuki



Length 28 mm

Part No.	Pack of	Ø x Pitch
BN177	25	M10 x 1.25 mm

Brake System: Akebono, Nissan, Sumitomo

Suits: Honda, MG, Rover



Length 29.5 mm

Part No.	Pack of	Ø x Pitch
BN179	25	M10 x 1.5 mm

Brake System: Bosch, Sumitomo, Wagner

Suits: Cadillac, Chrysler, Ford, Opel, Vauxhall

Bleed Screws Male - Imperial



Length 25.5 mm

Part No.	Pack of	Ø x Pitch
BN102	25	5/16" x 24 UNF

Brake System: Akebono, Mando, Sumitomo

Suits: Hyundai, Kia



Length 28 mm

Part No.	Pack of	Ø x Pitch
BN71	25	1/4" UNF x 28 TPI

Suits: Iveco, Rover, Volvo



Length 32.5 mm

Part No.	Pack of	Ø x Pitch
BN72	25	3/8" UNF x 24 TPI

Suits: British Vehicles



Assorted Box of Brake Tubing Connectors & Brake Bleed Screws - UNF & Metric For 3/16" pipe.

Part No.	Box of
AB85N	63 Pieces

1 x Male Connector: 10 x 1.00 mm.
2 x Female Connectors: 3/8" UNF x 24 TPI, 10 x 1.00 mm.
2 x 3-way Connectors: 3/8" UNF x 24 TPI, 10 x 1.00 mm.
5 x Brake Bleed Screws: 1/4" UNF x 28 TPI, 3/8" UNF x 24 TPI, M7 x 1.00 mm, M8 x 1.25 mm, M10 x 1.00 mm.



Brake Pad Pin Retainers

Part No.	Pack of	Size	Wire Ø
BR6	100	Small	1.2 mm
BR7	100	Large	1.5 mm

Looking for Brake Pipe Tools?

Our full range can be found from Page 474



Brake Hardware - Pins

Part No.	Pack of	Suits	Length x End Width
BR51	100	Ford	42 x 6 mm
BR52	100	Rover	42 x 8 mm
BR53	100	GM	36 x 6 mm



Brake Hardware - Washers

Part No.	Pack of	Type	Hole Width
BR61	100	Lockheed	8 mm
BR62	100	Girling	6 mm

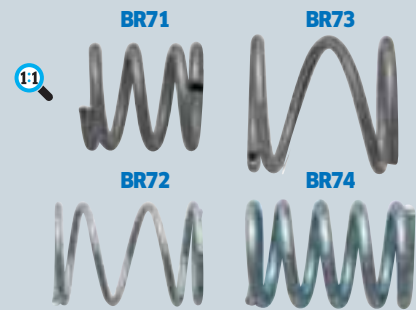

Brake Hardware - Springs

Part No.	Pack of	Suits	Dimensions (Ø x H)
BR71	100	Ford	14.5 x 16.5 mm
BR72	100	GM	14.0 x 20.0 mm
BR73	100	Lockheed	18.5 x 20.0 mm
BR74	100	BL	14.5 x 22.5 mm



Assorted Box of Brake Shoe Hold-Down Kit

Part No.	Box of
AB145N	200 Pieces

3 x Pins, Suits: FORD, GM, ROVER. 2 x Washers: LOCKHEED, GIRLING.
4 x Springs, Suits: FORD, VAUXHALL/GM, Lockheed, BL.





Gasket Paper - 1 m²

Part No.	Pack of	Thickness
GT14	2	0.4 mm (1/64")
GT18	2	0.8 mm (1/32")

Gasket Paper - 30 x 25 cm (12" x 10")

Part No.	Pack of	Thickness
GT5	50	0.4 mm (1/64")
GT6	50	0.8 mm (1/32")

Assorted Pack of Gasket Paper - 30 x 25 cm (12" x 10")

Part No.	Pack of
AP11	30 Pieces

20 x Sheets: 0.4 mm Thick. 10 x Sheets: 0.8 mm Thick.



Assorted Box of Accelerator & Clutch Springs

Part No.	Box of
AB29	40 Pieces

8 x Sizes (Free Length x O.D.): 53 x 12.4 mm, 61.2 x 15.4 mm, 63.4 x 13 mm, 66 x 13.1 mm, 77.4 x 23.15 mm, 82.5 x 12.95 mm, 84.2 x 10.9 mm, 86 x 13.3 mm.



Diesel Fuel Filters

Large in-line type. Hose fitting: 6 or 8 mm Ø.
European manufactured high quality finish.

Part No.	Pack of	Description
DCL64	10	Diesel Fuel Filters



In-Line Fuel Filters - Large

Hose fitting: 6 or 8 mm Ø.

Part No.	Pack of	Description
DCL63	10	Large Fuel Filters



In-Line Fuel Filters - Small

Hose fitting: 6 or 8 mm Ø.

Part No.	Pack of	Description
DCL62	10	Small Fuel Filters

CHEMICO Grinding Paste

Silicone carbide and lithium based grease.
Double-ended tin of Coarse and Fine paste.

- A handy supply of a Coarse paste to cut and a Fine paste to finish.
- It has inherent shear stability, corrosion protection and good sealing properties.

Part No.	Pack of	Size
GLU13	4	110g Tin



Valve Grinding Sticks

Double ended suction cup.

Part No.	Pack of	Description
TL882A	2	Valve Grinding Sticks

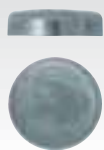

Assorted Box of Core Plugs Cup Type - Metric

Zinc plated mild steel.

Part No. Box of

AB120 60 Pieces

10 x Sizes: 18, 22, 24, 26, 28, 30, 32, 34, 36, 48 mm.



Assorted Box of Core Plugs Cup Type - Imperial

Zinc plated mild steel.

Part No. Box of

AB30N 38 Pieces

8 x Sizes: 7/8", 1 1/4", 1 1/2", 1 5/8", 1 3/4", 1 7/8" (48 mm), 1 5/16", 2".



KS TOOLS Oil Pan Repair Kit

Supplied in robust plastic storage case.

Part No. Qty Description

K150.1450 1 Set 64 Piece Set

4 x Special taps: M13 x 1.5, M15 x 1.5, M17 x 1.5, M20 x 1.5 mm.
 4 x Oil drain plugs, hex drive: M13 x 1.5 x 8 mm (x 5), M15 x 1.5 x 19 mm (x 5), M17 x 1.5 x 8 mm (x 5), M20 x 1.5 x 10 mm (x 5).
 4 x Aluminium seals: M13 (x 10), M15 (x 10), M17 (x 10), M20 (x 10).



Plastic Sump Plug - BMW Type

Replaces BMW OEM 11137605018.

Part No. Qty Description

HSUP4 1 BMW Type



Plastic Sump Plug - FORD Connect Type

Replaces Ford OEM 1830727.

Part No. Qty Description

HSUP3 1 FORD Connect Type



Plastic Sump Plug - FORD Large Type

Replaces Ford OEM 1871598 and Peugeot/Citroën OEM 9801444780.

Part No. Qty Description

HSUP2 1 FORD Large Type



Plastic Sump Plug - VW Type

Replaces VW OEM 06L103801.

Part No. Qty Description

HSUP1 1 VW Type



Sump Plugs, Kits + Washers



CITROËN/PEUGEOT/FORD Type - M10 x 1.25 x 13 mm

Part No.	Pack of	Description
HSU95	5	Sump Plugs
HSU195	2 Pc Kit	Sump Plug Kit c/w Washer
HSU1022	50	Flat Copper Washers 10 x 20 x 2.0 mm

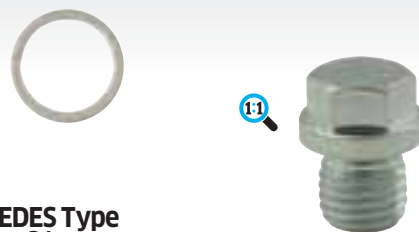

BMW/MERCEDES Type - M12 x 1.50 x 21 mm

Part No.	Pack of	Description
HSU101	2	Sump Plugs
HSU1215	50	Aluminium Washers 12 x 15 x 1.5 mm



NISSAN/TOYOTA Type - M12 x 1.25 x 13 mm

Part No.	Pack of	Description
HSU93	5	Sump Plugs
HSU193	5 Pc Kit	Sump Plug Kit c/w Washers
HSU1217	50	Flat Copper Washers 12 x 17 x 1.5 mm
HSU1217AL	50	Aluminium Washers 12 x 17 x 1.5 mm
HSU45	50	Copper Compression Washers 12 x 17 x 2.0 mm
HSU40	50	Fibre Washers 12 x 24 x 2.0 mm

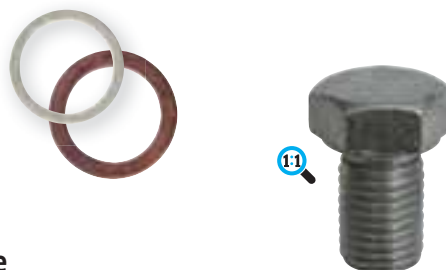

BMW Type - M12 x 1.50 x 18 mm

Part No.	Pack of	Description
HSU81	5	Sump Plugs
HSU181	3 Pc Kit	Sump Plug Kit c/w Washers
HSU1215	50	Aluminium Washers 12 x 15 x 1.5 mm
HSU1217	50	Flat Copper Washers 12 x 17 x 1.5 mm



ALFA ROMEO/FIAT Type - M12 x 1.25 x 18 mm

Part No.	Pack of	Description
HSU104	2	Sump Plugs
HSU1217	50	Flat Copper Washers 12 x 17 x 1.5 mm



VAUXHALL Type - M12 x 1.75 x 25 mm

Part No.	Pack of	Description
HSU96	5	Sump Plugs
HSU196	2 Pc Kit	Sump Plug Kit c/w Washer
HSU60	50	Flanged Rubber O-Rings 11 x 21 x 2.5 mm





MINI Type
- M12 x 1.75 x 28.5 mm

Part No.	Pack of	Thread Size
HSU88	5	Sump Plugs c/w Washer
HSU60	50	Flanged Rubber O-Rings 11 x 21 x 2.5 mm



BEST SELLER

AUDI/VW Type
- M14 x 1.50 x 17.5 mm

Part No.	Pack of	Thread Size
HSU92	5	Sump Plugs c/w Captive Washer



HONDA/LAND ROVER/ROVER Type
- M14 x 1.25 x 21 mm

Part No.	Pack of	Description
HSU105	2	Sump Plugs
HSU25	50	Aluminium Washers 14 x 22 x 2.0 mm



VAUXHALL Type
- M14 x 1.50 x 10 mm

Part No.	Pack of	Description
HSU90	5	Sump Plugs
HSU190	2 Pc Kit	Sump Plug Kit c/w O-Ring
HSU50	50	Nitrile Rubber O-Rings 18 x 2 NBR



CITROËN/PEUGEOT Type
- M14 x 1.25 x 13 mm

Part No.	Pack of	Description
HSU84	5	Sump Plugs
HSU10	50	Copper Compression Washers 14 x 20 x 2.0 mm



Early FORD Type
- M14 x 1.50 x 16 mm

Part No.	Pack of	Description
HSU82	10	Sump Plugs
HSU182	3 Pc Kit	Sump Plug Kit c/w Seal & Washer
HSU21	50	Bonded Seals 16.7 x 24 mm
HSU20	50	Nylon Washers 14.5 x 22 x 2.0 mm

1:1 Actual Size Images



Sump Plugs, Kits + Washers



OPEL/VAUXHALL Type - M14 x 1.50 x 13 mm

Part No.	Pack of	Description
HSU83	10	Sump Plugs
HSU183	2 Pc Kit	Sump Plug Kit c/w Washer
HSU1420	50	Flat Copper Washers 14 x 20 x 1.5 mm



Early VAUXHALL Type - M14 x 1.50 x 12 mm

Part No.	Pack of	Description
HSU98	5	Sump Plugs
HSU198	2 Pc Kit	Sump Plug Kit c/w Washer
HSU1420	50	Flat Copper Washers 14 x 20 x 1.5 mm



AUDI/VW Type - M14 x 1.50 x 17.5 mm

Part No.	Pack of	Description
HSU91	5	Sump Plugs
HSU191	2 Pc Kit	Sump Plug Kit c/w Washer
HSU1420	50	Flat Copper Washers 14 x 20 x 1.5 mm



CHRYSLER/FORD Type - M14 x 1.50 x 21 mm

Part No.	Pack of	Description
HSU87	5	Sump Plugs
HSU187	2 Pc Kit	Sump Plug Kit c/w Washer
HSU51	50	Flanged Rubber O-Rings 13 x 22 x 3.0 mm



MERCEDES/CHRYSLER Type - M14 x 1.50 x 24 mm

Part No.	Pack of	Description
HSU94	5	Sump Plugs
HSU194	2 Pc Kit	Sump Plug Kit c/w Washer
HSU1420	50	Flat Copper Washers 14 x 20 x 1.5 mm



CITROËN/PEUGEOT/RENAULT Type - M16 x 1.50 x 14 mm

Part No.	Pack of	Description
HSU85	5	Sump Plugs
HSU185	3 Pc Kit	Sump Plug Kit c/w Washers
HSU11	50	Copper Compression Washers 16 x 22 x 2.0 mm
HSU21	50	Bonded Seals 16.7 x 24 mm



Actual Size Images



ALFA/FIAT/LANCIA Type
- M18 x 1.50 x 27 mm

Part No.	Pack of	Description
HSU97	5	Sump Plugs
HSU197	2 Pc Kit	Sump Plug Kit c/w Washer
HSU1826	50	Flat Copper Washers 18 x 26 x 1.5 mm



PORSCHE Type
- M18 x 1.50 x 16 mm

Part No.	Pack of	Description
HSU106	2	Sump Plugs
HSU1824AL	50	Aluminium Washers 18 x 24 x 1.5 mm

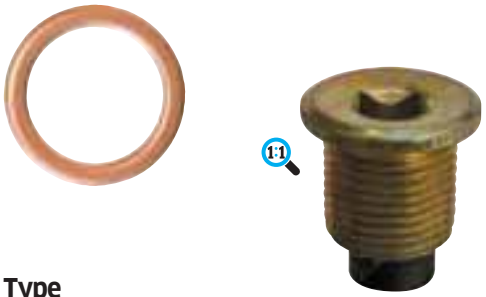

RENAULT Type
- M18 x 1.50 x 15 mm

Part No.	Pack of	Description
HSU86	5	Sump Plugs
HSU186	2 Pc Kit	Sump Plug Kit c/w Washer
HSU12	50	Copper Compression Washers 18 x 24 x 2.0 mm

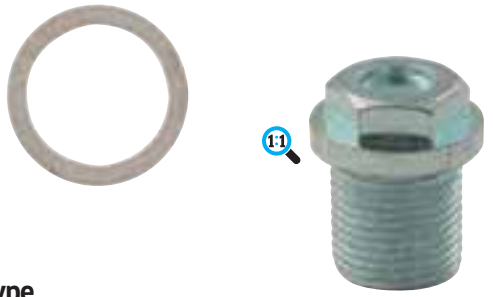

VOLVO Type
- M18 x 1.50 x 28 mm

Part No.	Pack of	Description
HSU107	2	Sump Plugs
HSU1824AL	50	Aluminium Washers 18 x 24 x 1.5 mm



GM Type
- M18 x 1.50 x 31.5 mm

Part No.	Pack of	Description
HSU102	2	Sump Plugs
HSU21	50	Bonded Seals 16.7 x 24 mm



FIAT Type
- M22 x 1.50 x 15 mm

Part No.	Pack of	Description
HSU89	5	Sump Plugs



Sump Plug Washers



BEST SELLER

Copper Compression Washers

Part No. Pack of I.D. x O.D. x Thickness

HSU45 50 **12 x 17 x 2.0 mm**

Suits TOYOTA Auris, Avensis, Camry, Carina, Celica, Corolla, Corona, Hiace, Hilux, Land Cruiser, Prius, Rav 4, Starlet, Supra, Yaris.



BEST SELLER

Flat Copper Washers

Part No. Pack of I.D. x O.D. x Thickness

HSU1022 50 **10 x 20 x 2.0 mm**

Suits CITROËN Berlingo, C1, C2, C3, C4, C5, C6, Xantia, Xsara. FIAT Scudo. MINI R56, R55, Clubman. PEUGEOT 107, 206, 207, 306, 307, 308, 406, 407, 607, 806, 807, 1007, 4007, Bipper, Expert, Partner. TOYOTA Aygo, Corolla. VOLVO C30, S40 II, V50.



BEST SELLER

Flat Copper Washers

Part No. Pack of I.D. x O.D. x Thickness

HSU14 50 **14 x 20 x 2.0 mm**

Suits VAUXHALL, VW (Except Beetle).



BEST SELLER

Copper Compression Washers

Part No. Pack of I.D. x O.D. x Thickness

HSU10 50 **14 x 20 x 2.0 mm**

Suits CITROËN (9/93->), PEUGEOT (9/93->).



Flat Copper Washers

Part No. Pack of I.D. x O.D. x Thickness

HSU1217 50 **12 x 17 x 1.5 mm**

Suits BMW Series 1, 3, 5, 6, 7, X3, X5, X6, Z1, Z3, Z4.



Flat Copper Washers

Part No. Pack of I.D. x O.D. x Thickness

HSU26 50 **16.3 x 25.4 x 2.0 mm**

Suits ROVER Mini, Metro & 100 Series.



BEST SELLER

Copper Compression Washers

Part No. Pack of I.D. x O.D. x Thickness

HSU11 50 **16 x 22 x 2.0 mm**

Suits CITROËN (<9/93), PEUGEOT (<9/93), RENAULT 5, FIAT (Diesel), ROVER (Diesel).



Flat Copper Washers

Part No. Pack of I.D. x O.D. x Thickness

HSU27 50 **14 x 19 x 2.0 mm**

Suits ROVER (Non-HONDA Engines inc. K Series, Except Diesel & Mini A Series).



Flat Copper Washers

Part No. Pack of I.D. x O.D. x Thickness

HSU1826 50 **18 x 26 x 1.5 mm**

Suits ALFA ROMEO 145, 146, 147, 155, 156, 159, 166, Brera, GT, GTV, Spider. FIAT Brava, Bravo, Coupe, Doblo, Idea, Mera, Multipla, Stilo, Strada. LANCIA Delta, Kappa, Lybra, Musa, Thesis. SUZUKI SX4.



Copper Compression Washers

Part No. Pack of I.D. x O.D. x Thickness

HSU12 50 **18 x 24 x 2.0 mm**

Suits RENAULT (Except RENAULT 5).



Flat Copper Washers

Part No. Pack of I.D. x O.D. x Thickness

HSU1420 50 **14 x 20 x 1.5 mm**

Suits VAUXHALL Astra, Cavalier, Combo, Corsa, Corsavan, Nova. OPEL/VAUXHALL Ascona, Astra, Calibra, Carlton, Cavalier, Corsa, Frontera, Kadett, Manta, Nova, Omega, Rekord, Senator, Tigra, Vectra, Zafira. CHRYSLER 300 C, PT Cruiser, Voyager. MERCEDES Klasse A, B, CE, G, V, GL, MSL, SLK, Sprinter, T1, Vaneo, Vito. AUDI 80, 90, 100, 200, A4, A6, A8, Quattro. SEAT Ibiza, Inca. SKODA Fabia, Felicia. VW Caddy, Fox, Golf I.



Flat Copper Washers

Part No. Pack of I.D. x O.D. x Thickness

HSU35 50 **19 x 26 x 2.0 mm**

Suits VOLVO (Other than 3 Series).

1:1

Actual Size Images

PLEASE NOTE:
Vehicle listings for sump plugs/washers are for guidance only

BEST SELLER

Nitrile Rubber O-Rings

Part No.	Pack of	I.D. x Thickness
HSU50	50	18 x 2 NBR

Suits VAUXHALL Astra F G H, Combo, Corsa B C D, Vectra B C.		
---	--	--



Aluminium Washers

Part No.	Pack of	I.D. x O.D. x Thickness
HSU1215	50	12 x 15 x 1.5 mm

Suits BMW Series 1, 3, 5, 6, 7, X3, X5, X6, Z1, Z3, Z4.		
---	--	--

BEST SELLER

Fibre Washers

Part No.	Pack of	I.D. x O.D. x Thickness
HSU40	50	12 x 24 x 2.0 mm

Suits TOYOTA Auris, Avensis, Camry, Carina, Celica, Corolla, Corona, Hiace, Hilux, Land Cruiser, Prius, Rav 4, Starlet, Supra, Yaris.		
---	--	--



Flanged Rubber O-Rings

Part No.	Pack of	I.D. x O.D. x Thickness
HSU60	50	11 x 21 x 2.5 mm

Suits VAUXHALL Astra G, Omega B, Signum, Vectra BC, Zafira.		
---	--	--



Aluminium Washers

Part No.	Pack of	I.D. x O.D. x Thickness
HSU1217AL	50	12 x 17 x 1.5 mm

Suits BMW Series 1, 2, 3, 5, 7, 8, X5, Z4. MERCEDES 190, SL, CLK, T1, Klasse C, E, G, S. MINI One D.		
---	--	--



Fibre Washers

Part No.	Pack of	I.D. x O.D. x Thickness
HSU41	50	18 x 29 x 2.0 mm

Suits TOYOTA (Large Engines inc. Supra).		
--	--	--

BEST SELLER

Flanged Rubber O-Rings

Part No.	Pack of	I.D. x O.D. x Thickness
HSU51	50	13 x 22 x 3.0 mm

Suits CHRYSLER 300, Caravan, Cirrus, Crossfire, Le Baron, Neo, PT Cruiser, Sebring, Stratus, Voyager. FORD C-Max, Cougar, Courier, Escort, Fiesta, Focus, C-Max Focus, Fusion, Galaxy, Ka, Maverick, Mondeo, Puma, S-Max, Transit.		
---	--	--

BEST SELLER

Aluminium Washers

Part No.	Pack of	I.D. x O.D. x Thickness
HSU25	50	14 x 22 x 2.0 mm

Suits ROVER (All HONDA Engines), HONDA (New Models).		
--	--	--

BEST SELLER

Bonded Seals

Part No.	Pack of	I.D. x O.D.
HSU21	50	16.7 x 24 mm

Suits FORD Mondeo (Zetec Engines). FORD Focus & KA.		
---	--	--



Nylon Washers

Part No.	Pack of	I.D. x O.D. x Thickness
HSU19	50	13 x 20 x 2.0 mm

Suits FORD OHV.		
-----------------	--	--



Aluminium Washers

Part No.	Pack of	I.D. x O.D. x Thickness
HSU1824AL	50	18 x 24 x 1.5 mm

Suits VOLVO, PORSCHE.		
-----------------------	--	--



Nylon Washers

Part No.	Pack of	I.D. x O.D. x Thickness
HSU20	50	14.5 x 22 x 2.0 mm

Suits FORD OHC.		
-----------------	--	--



Aluminium Washers

Part No.	Pack of	I.D. x O.D. x Thickness
HSU30	50	22 x 27 x 1.5 mm

Suits FIAT (Except Diesel), MERCEDES (Some).		
--	--	--

BEST SELLER

Sump Plug Washers

Part No.	Box of
AB117N	265 Pieces

4 x Copper Compression: 12 x 17 x 2.00, 14 x 20 x 2.0, 16 x 22 x 2.0, 18 x 24 x 2.0 mm.	
4 x Flat Copper: 10 x 20 x 2.00, 12 x 17 x 1.5, 14 x 20 x 1.5, 14 x 20 x 2.0 mm.	
2 x Aluminium: 14 x 22 x 2.0, 18 x 24 x 1.5 mm.	
2 x Flanged Rubber O-ring: 11 x 21 2.5, 13 x 22 x 3.0 mm.	
1 x Nitrile Rubber O-Ring: 18 x 2 NBR.	
1 x Fibre: 12 x 24 x 2.0 mm.	
1 x Bonded Seal: 16.7 x 24 mm.	





Heavy Duty Exhaust Clamps

Zinc plated steel.
U-type with M10 nuts/thread.

Part No.	Pack of	Size	
EXHD42	10	42 mm	(1 5/8")
EXHD45	10	45 mm	(1 3/4")
EXHD48	10	48 mm	(1 7/8")
EXHD50	10	50 mm	(2")
EXHD52	10	52 mm	(2 1/16")
EXHD54	10	54 mm	(2 1/8")
EXHD58	10	58 mm	(2 1/4")
EXHD60	10	60 mm	(2 3/8")
EXHD65	10	65 mm	(2 1/2")
EXHD67	10	67 mm	(2 5/8")
EXHD70	10	70 mm	(2 3/4")



Exhaust Clamps

Zinc plated steel.
U-type with M8 nuts/thread.

Part No.	Pack of	Size	
EX118	20	29 mm	(1 1/8")
EX114	20	32 mm	(1 1/4")
EX138	20	35 mm	(1 3/8")
EX112	20	38 mm	(1 1/2")
EX116	20	42 mm	(1 11/16")
EX134	20	45 mm	(1 3/4")
EX178	20	48 mm	(1 7/8")
EX2	20	51 mm	(2")
EX216	20	52 mm	(2 1/16")
EX218	20	54 mm	(2 1/8")
EX214	20	58 mm	(2 1/4")
EX238	20	60 mm	(2 3/8")
EX212	20	65 mm	(2 1/2")
EX258	20	67 mm	(2 5/8")
EX234	20	70 mm	(2 3/4")
EX3	20	76 mm	(3")
EX318	10	79 mm	(3 1/8")
EX314	10	83 mm	(3 1/4")
EX312	10	89 mm	(3 1/2")
EX358	10	92 mm	(3 5/8")
EX334	10	95 mm	(3 3/4")
EX4	10	102 mm	(4")
EX436	10	106 mm	(4 3/16")
EX414	10	108 mm	(4 1/4")
EX456	10	110 mm	(4 5/16")
EX412	10	115 mm	(4 1/2")
EX434	10	120 mm	(4 3/4")
EX5	10	127 mm	(5")
EX518	10	130 mm	(5 1/8")

Assorted Pack of Exhaust Clamps

Zinc plated steel. U-type with M8 nuts/thread.

Part No.	Pack of
AP59	15 Pieces

Sizes: 1 3/8" - 2"



Assorted Pack of Exhaust Clamps

Zinc plated steel. U-type with M8 nuts/thread.

Part No.	Pack of
AP37	24 Pieces

Sizes: 1 1/2" - 2 1/2"



Perforated Strip

Suits exhaust.

Part No.	Pack of	Description
PS2	10	24" Lengths

Perforated Strip

Suits radio fixing.

Part No.	Pack of	Description
PS1	10	12" Lengths

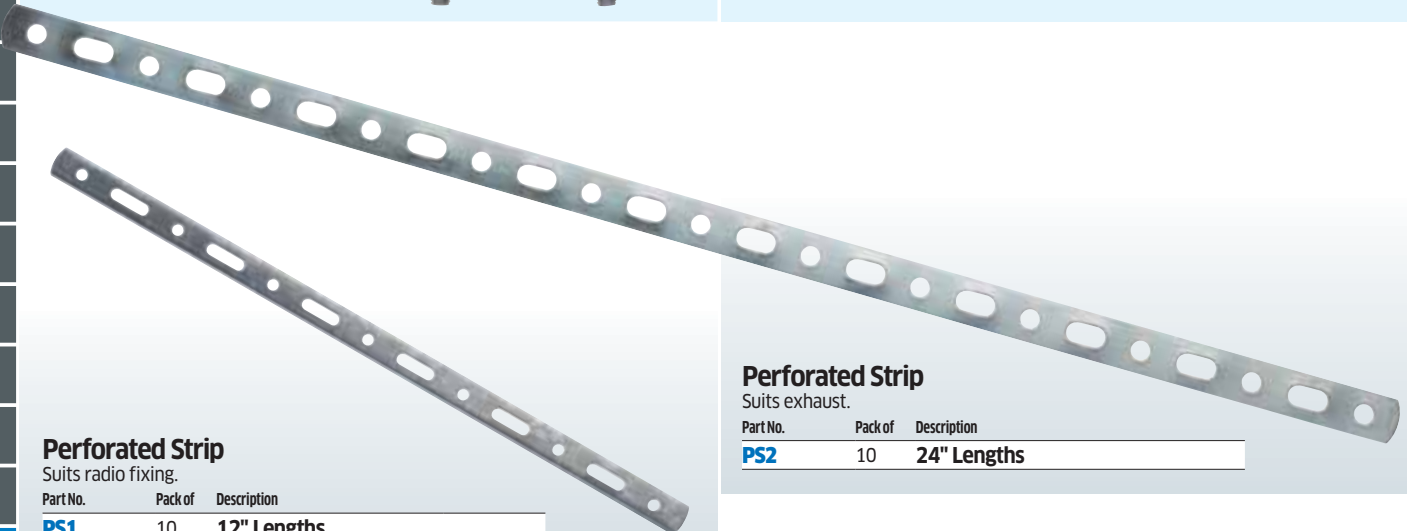

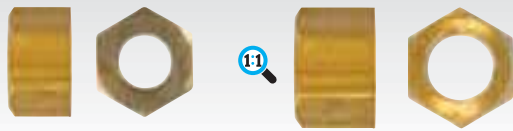

Exhaust Manifold Nuts - Brass

Part No.	Pack of	Size x Pitch
HBN5	50	M8 x 1.25 mm
HBN6	50	M10 x 1.25 mm

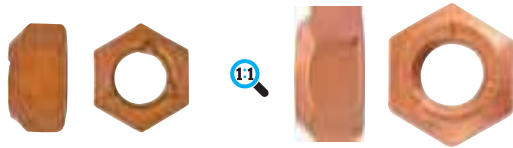

Exhaust Manifold Nuts - Copper Flashed Steel

DIN 980.

Part No.	Pack of	Size x Pitch
HBN8	50	M8 x 1.25 mm
HBN7	50	M10 x 1.50 mm



Exhaust Manifold Nuts - Zinc Plated Steel

Non-serrated. Flanged tri-lock. 9/16" (14 mm) AF head. DIN 980. Grade 8.8.

Part No.	Pack of	Size
HBN10	50	M10 x 1.25 mm



Exhaust Mounting Rings

Universal application.

Part No.	Pack of	Size	I.D.
EM3	10	Medium	35 mm
EM4	10	Large	45 mm



Actual Size Images



Exhaust Manifold Studs

Mild steel.

Part No.	Pack of	Size x Pitch	Length
HMS11	20	M8 x 1.25 mm	37 mm
HMS12	20	M8 x 1.25 mm	42 mm
HMS13	20	M10 x 1.25 mm	37 mm
HMS14	20	M10 x 1.50 mm	38 mm
HMS15	20	M10 x 1.50 mm	52 mm
HMS16	20	M10 x 1.50 mm	55 mm



Assorted Box of Exhaust Manifold Studs & Nuts - Metric

Part No.	Box of
AB116	72 Pieces

2 x Nuts, Copper Flashed Steel (Size x Pitch): M8 x 1.25 mm, M10 x 1.50 mm.
 2 x Nuts, Brass (Size x Pitch): M8 x 1.25 mm, M10 x 1.25 mm.
 5 x Studs (Size x Pitch x Length): M8 x 1.25 mm x 37 mm, M10 x 1.25 mm x 37 mm, M10 x 1.50 mm x 38 mm, M10 x 1.50 mm x 52 mm, M10 x 1.50 mm x 55 mm.



Exhaust Mountings

MINI bobbin (cotton reel).

Part No.	Pack of	Thread
EM1	10	5/16" UNF





IGUANA Universal Jointless Aero Wiper Blades

Each kit is complete with seven, quick and easy to fit connectors to suit the majority of vehicle applications (see below).

- Rubber blade edge is manufactured from a unique natural and synthetic rubber mix, designed to offer quality wiping performance with enhanced durability and life span
- Aero design provides improved performance by reducing wind lift and noise at high speeds
- Manufactured with two tensioned steel strips which apply the whole length of the blade to the windscreen with even, consistent pressure

Part No.	Qty	Length	
WIPG13	1 Kit	13"	(335 mm)
WIPG14	1 Kit	14"	(360 mm)
WIPG15	1 Kit	15"	(385 mm)
WIPG16	1 Kit	16"	(410 mm)
WIPG17	1 Kit	17"	(435 mm)
WIPG18	1 Kit	18"	(460 mm)
WIPG19	1 Kit	19"	(485 mm)
WIPG20	1 Kit	20"	(510 mm)
WIPG21	1 Kit	21"	(535 mm)
WIPG22	1 Kit	22"	(560 mm)
WIPG23	1 Kit	23"	(585 mm)
WIPG24	1 Kit	24"	(610 mm)
WIPG25	1 Kit	25"	(625 mm)
WIPG26	1 Kit	26"	(660 mm)
WIPG28	1 Kit	28"	(710 mm)
WIPG30	1 Kit	30"	(760 mm)
WIPG32	1 Kit	32"	(815 mm)

Each jointless IGUANA Universal Jointless Aero Blade incorporates a centralised rubber spoiler which allows fitment to fit right-hand drive and left-hand drive vehicles as well as vehicles with 'clapping' blades. Each blade comes complete with seven different connectors to cover the majority of vehicle applications:



Connector Suits:
Alfa Romeo, Audi, BMW, Cadillac, Chevrolet, Citroen, Fiat, Jaguar, Kia, Mercedes, Nissan, Opel, Peugeot, Renault, Saab, Seat, Vauxhall, Volkswagen, Volvo.



Connector Suits:
Alfa Romeo, Audi, BMW, Citroen, Fiat, Ford, Mazda, Mercedes, Nissan, Opel, Peugeot, Porsche, Renault, Skoda, Vauxhall, Volkswagen, Volvo.



Connector Suits:
Renault, Citroen, Fiat, Saab, Audi A6, Seat Altea.



Connector Suits:
Audi, Citroen, Fiat, Ford, Hyundai, Kia, Lancia, Peugeot, Renault, Seat, Skoda, Volkswagen, Volvo.



Connector Suits:
Audi, Volkswagen.



Main Blade Adaptor
For use with selected Connectors



Single Connector with extra adaptor
Suits: Audi, Mercedes.



Universal Fit Single Connector
For all vehicles with 9 x 4 mm and 9 x 3 mm Hook Wiper Arms.



Windscreen Washer Accessories

Nylon. Suits 3/16" pipe.



Part No.	Qty	Description
TA103	5	T-Pieces



Part No.	Qty	Description
TA102	5	Elbows

BEST SELLER



Part No.	Qty	Description
TA101	5	Straights



Part No.	Qty	Description
TA104	5	Small In-Line Valves



Part No.	Qty	Description
TA105	5	Large In-Line Valves

Assorted Pack of Windscreen Washer Accessories

Nylon. Suits 3/16" pipe.

Part No.	Pack of
AP61	25 Pieces

5 x Large In-Line Valves. 5 x Small In-Line Valves. 5 x Straights.
5 x Elbows. 5 x T-Pieces.



Windscreen Washer Pumps

Universal application. Suits 3/16" pipe.

Part No.	Qty	Volts
EC12	1	12v
EC24	1	24v



Parking Permit/Licence Holders

Assorted colours (may vary).

Part No.	Qty	Type
DC62	10	Self Seal

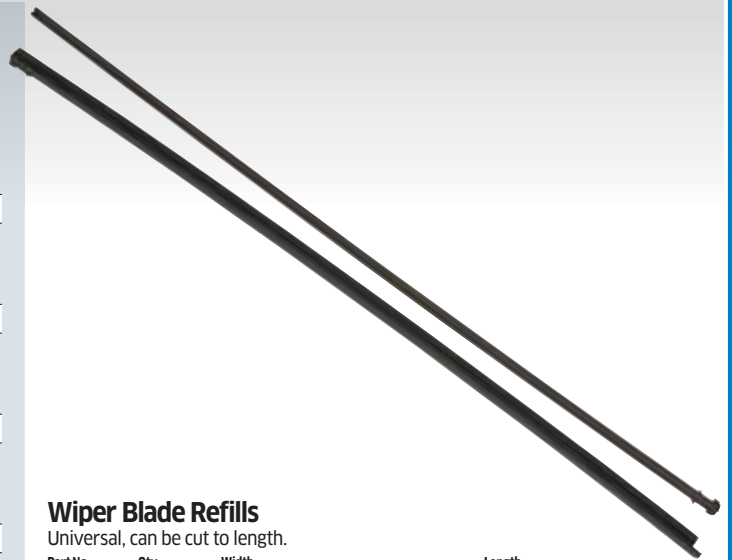

Wiper Blade Refills

Universal, can be cut to length.

Part No.	Qty	Width	Length
WIP4	10 Pairs	8 mm (Wide)	20" (508 mm)
WIP5	5 Pairs	8 mm (Wide)	28" (711 mm)

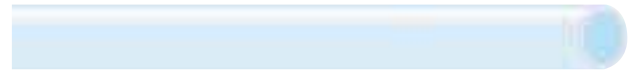

PVC Tubing - Clear Plain Windscreen Washer Type

Part No.	Length	O.D. x I.D.
TUB12	30 m Coil	8 x 5 mm (3/16")

SAS

S-A-S Concentrated Screen Wash

Designed with powerful detergents and an anti-freeze agent to prevent washer jets freezing in the wintertime, and to clear summer fly squash.

- **Lowest working temperature: -7.6°C.**

Part No.	Pack of	Size
SAS1060/2	2	5 Litre Containers



Looking for more Screen Wash?

Our full range can be found on Page 289





VTG6A MoT Plate Holder - Heavyweight

Black powder coated steel with clear plastic window.

Part No.	Qty	Dimensions
TT43	1	201 x 184 mm



VTG6A MoT Plate Holder - Lightweight

Rustproof glass filled nylon with clear plastic window.

Part No.	Qty	Dimensions
TT44	1	187 x 180 mm



Poly Coated Wire

1.5 mm Ø steel wire with polyester sleeve (overall Ø: 2.5 mm).

Part No.	Qty	Description
AC250	1 Coil	2.5 mm x 100 m Wire



Ferrules for Poly Coated Wire

Suits Part No. AC250.

Part No.	Pack of	Description
AC251	100	2.5 mm Ferrules



Diesel Stop/Bonnet Cables with T-handle and Bowden Cable Inner

Part No.	Pack of	Length
AC6	2	2.44 m (8 ft)
AC8	1	3.96 m (13 ft)



Bowden Cable

Part No.	Length	Ø
AC4	30 m Coil	1.50 mm



Diesel Stop Cables with Piano Wire Inner

Universal fitting. Piano wire 2 mm Ø

Part No.	Pack of	Length
AC3	2	2.89 m (9 ft 6")
AC13	1	3.96 m (13 ft)



Locking Wire

Heavy galvanised steel. 0.5 kg coil.

Part No.	Qty	Wire Ø	Approx. Length
AC7	1 Coil	1.25 mm (18 SWG)	52 m
AC11	1 Coil	2.00 mm (14 SWG)	21 m

BEST SELLER



MOT Corrosion Assessment Hammer

VOSA Approved.

Part No.	Qty	Description
TL730	1	MOT Corrosion Hammer



Anitluce Fasteners - Standard Round Shank Weld or Rivet

Part No.	Pack of	Shank Dia x Length
TT20	10	1/2" x 1/2"

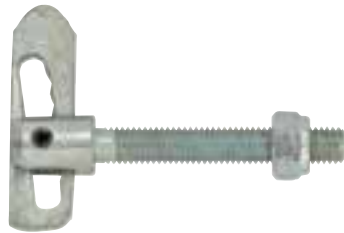

Anitluce Fasteners - Threaded with Nut

Part No.	Pack of	Thread Size x Length
TT22	10	1/2" x 3"



Anitluce Fasteners - Threaded without Nut

Part No.	Pack of	Thread Size x Length
TT21	10	12 mm x 33 mm



Solderless Nipples

Part No.	Pack of	Size
AC101	50	1/4" x 3/8"
AC103	50	11/32 x 1/2"
AC104	50	9/32 x 1/2"

Assorted Pack of Solderless Nipples

Part No.	Pack of
AP9	25 Pieces
Various sizes and types.	

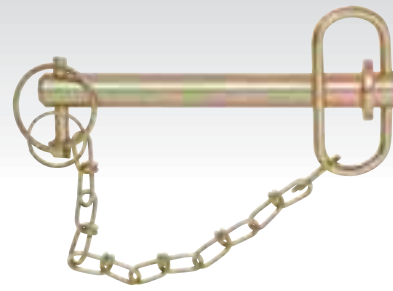

Tow Pin Assemblies

Part No.	Qty	Pin Ø	Pin Working Length	Pin Total Length
TT120	1	20 mm	160 mm	195 mm
TT122	1	22 mm	155 mm	205 mm
TT124	1	25 mm	155 mm	205 mm



Roller Shutter Hooks & Chains

Part No.	Pack of	Spring Hook	Chain Length
TT27	10	3" (75 mm)	8" (200 mm)
TT35	10	4" (100 mm)	12" (305 mm)



Rope Hooks - Bolt-on

Cast iron.

Part No.	Pack of	Description
TT31	10	Bolt-on Rope Hooks



Wire Rope Grips

Zinc plated.

Part No.	Pack of	Size
TT33	10	6 mm
TT38	10	8 mm



Double Type R-Clip Module Assembly

R-clip dimensions (Wire Ø x L): 3.7 x 95 mm.

Part No.	Pack of	Description
HY20	10	R-Clip Module Assembly





Ratchet Strap with Claws

Polyester strap with metal claws.

Part No.	Qty	Capacity	Length
AC15	3 Piece Set	4 Tonnes	4 m



WARRIOR 1T Ratchet Strap with Claw Hooks

Certified to EN-12195-2. 1 year guarantee from first day of use.

Part No.	Qty	Width x Length	Lashing Capacity	Breaking Strength
AC5150	2 Piece Set	25 mm x 5.0 m	1,000 kg	1,250 kg



WARRIOR 4T Ratchet Strap with Claw Hooks

Certified to EN-12195-2. 1 year guarantee from first day of use.

Part No.	Qty	Width x Length	Lashing Capacity	Breaking Strength
AC5480	2 Piece Set	50 mm x 8.0 m	4,000 kg	6,000 kg



Car Transporter Ratchet Strap

Strap thickness: 50 mm. Polyester strap with metal claws.

Part No.	Qty	Capacity	Width x Length
AC14	2 Piece Set	5 Tonnes	50 mm x 10 m



Polypropylene Rope

10 mm (3/8") Ø.

Part No.	Qty	Length
AC10	1	220 m (720 ft)



Polythene Woven Tarp

Part No.	Qty	Dimensions
BAG18	1	5.49 x 3.66 m (18 x 12 ft)





**WARRIOR
Duplex Flat Lifting Sling**

BS EN 1492-1:2000 (7:1 Safety Factor). 1 year guarantee from first day of use.

Part No.	Qty	Colour	Width x Length	Working Load Limit
AC3120	1	Purple	30 mm x 2.0 m	1 Tonne
AC3130	1	Purple	30 mm x 3.0 m	1 Tonne

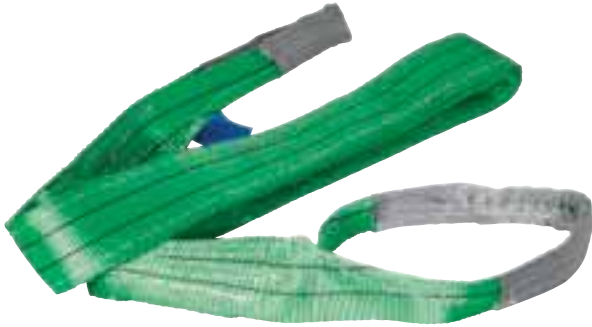

**WARRIOR
Duplex Flat Lifting Sling**

BS EN 1492-1:2000 (7:1 Safety Factor). 1 year guarantee from first day of use.

Part No.	Qty	Colour	Width x Length	Working Load Limit
AC3220	1	Green	60 mm x 2.0 m	2 Tonne
AC3240	1	Green	60 mm x 4.0 m	2 Tonne



**WARRIOR
Duplex Flat Lifting Sling**

BS EN 1492-1:2000 (7:1 Safety Factor). 1 year guarantee from first day of use.

Part No.	Qty	Colour	Width x Length	Working Load Limit
AC3320	1	Yellow	90 mm x 2.0 m	3,000 kg
AC3330	1	Yellow	90 mm x 3.0 m	3 Tonne
AC3340	1	Yellow	90 mm x 4.0 m	3 Tonne

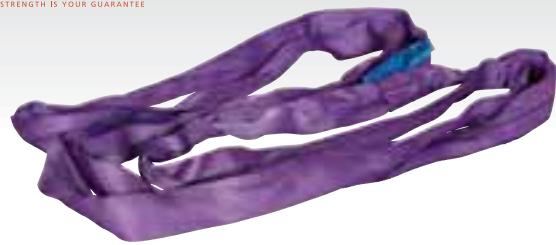

**WARRIOR
Endless Round Lifting Sling**

BS EN 1492-1:2000 (7:1 Safety Factor). 1 year guarantee from first day of use.

Part No.	Qty	Colour	Width x Length	Working Load Limit
AC4110	1	Purple	45 mm x 1.0 m	1,000 kg
AC4115	1	Purple	45 mm x 1.5 m	1,000 kg
AC4120	1	Purple	45 mm x 2.0 m	1,000 kg



**WARRIOR
Endless Round Lifting Sling**

BS EN 1492-1:2000 (7:1 Safety Factor). 1 year guarantee from first day of use.

Part No.	Qty	Colour	Width x Length	Working Load Limit
AC4205	1	Green	50 mm x 0.5 m	2,000 kg
AC4210	1	Green	50 mm x 1.0 m	2,000 kg
AC4220	1	Green	50 mm x 2.0 m	2,000 kg



**WARRIOR
Endless Round Lifting Sling**

BS EN 1492-1:2000 (7:1 Safety Factor). 1 year guarantee from first day of use.

Part No.	Qty	Colour	Width x Length	Working Load Limit
AC4520	1	Red	80 mm x 2.0 m	5,000 kg





7-Pin Trailer Sockets & Plugs

12N (Normal) system. 12V. Metal body.

Part No.	Pack of	Description
ERP13	5	Sockets
ERP14	5	Plugs



RING 7-Pin Trailer Sockets & Plugs

12N (Normal) system. 12V. Plastic body.

Part No.	Pack of	Description
ERP41	5	Sockets
ERP42A	1	Plugs
ERP42	5	Plugs



RING 7-Pin Trailer Socket

12N (Normal) system. 12V. Plastic body.

Part No.	Pack of	Description
ERP116	1	Socket



RING Trailer Board Extension Lead

12N (Normal) system. 12V.

Part No.	Qty	Length
ERP117	1	6 m

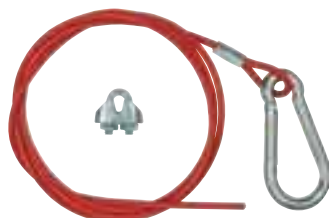

RING Breakaway Cable

For fitment to all trailers with a braking system. Sprung shackle for easy attachment to car, locking sprung shackle for quick and easy, permanent fitment to the handbrake of the trailer. No tools required.

Part No.	Pack of	Description
AC131	1	Breakaway Cable

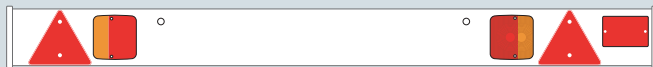
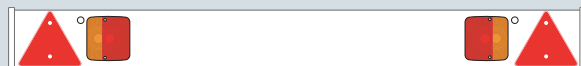
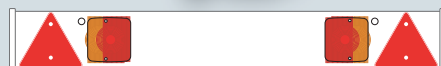

RING Trailer Boards

12N (Normal) system. 12V. Fitted with 7-Pin trailing plug.

Part No.	Qty	Width	Length
ERCT830P	1	3 ft	4 m Cable
ERCT816P	1	4 ft	6 m Cable
ERCT900P	1	4 ft 6" (incl. Fog Light)	4 m Cable



Magnetic LED Trailer Lights - Stop/Tail/Indicator

IP67. Supplied with 7.5 M cable, 2.5 M between lamps.

• Includes Reflector

Part No.	Qty	Voltage	Lights	ECE Reg
EBT9553	1 Set	12V	Stop/Tail/Ind	3/4/6/7



Magnetic Trailer Lights - Stop/Tail/Indicator

IP67. Supplied with 7.5 M cable, 2.5 M between lamps.

Part No.	Qty	Voltage	Lights	ECE Reg
EBT9550	1 Set	12V	Stop/Tail/Ind	4/6/7



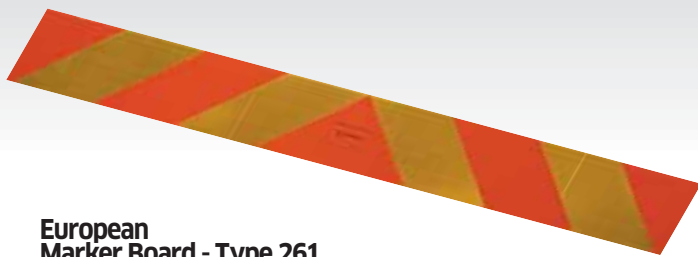

European Marker Board - Type 261

Aluminium. Conforms to ECE 70.

Part No.	Qty	ECE No.	Dimensions
MB261	1	ECE1	1130 x 130 mm

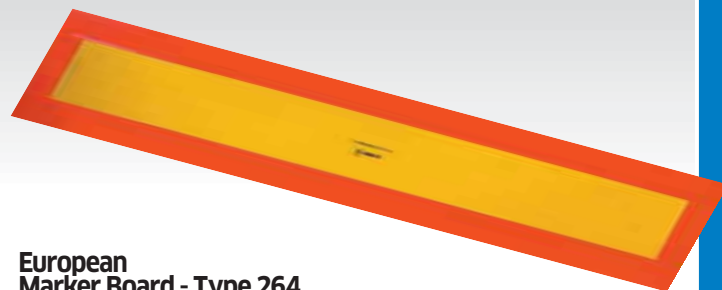

European Marker Board - Type 264

Aluminium. Conforms to ECE 70.

Part No.	Qty	ECE No.	Dimensions
MB264	1	ECE5	1130 x 195 mm

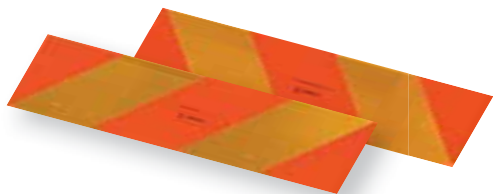

European Marker Boards - Type 262

Aluminium. Conforms to ECE 70.

Part No.	Qty	ECE No.	Dimensions
MB262	1 Pair	ECE2/3	565 x 130 mm



European Marker Boards - Type 265

Aluminium. Conforms to ECE 70.

Part No.	Qty	ECE No.	Dimensions
MB265	1 Pair	ECE6/7	565 x 195 mm

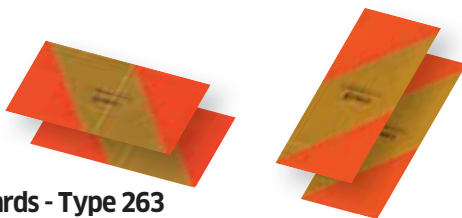

European Marker Boards - Type 263

Aluminium. Conforms to ECE 70.

Part No.	Qty	ECE No.	Dimensions
MB263	Set of 4	ECE4	282 x 130 mm

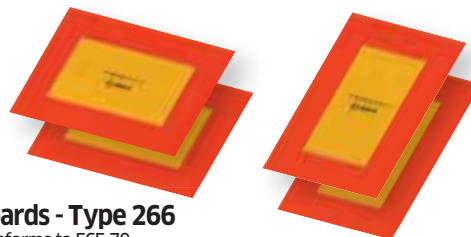

European Marker Boards - Type 266

Aluminium. Conforms to ECE 70.

Part No.	Qty	ECE No.	Dimensions
MB266	Set of 4	ECE8	282 x 192 mm



Round Reflectors

EN 12899-3:2007.

Conforms to ECE E20. Screw-on type.

Part No.	Qty	Colour	Diameter
REF3S	2	Red	63 mm
REF3	10	Red	63 mm
REF2S	2	Amber	63 mm
REF2	10	Amber	63 mm
REF4S	2	White	63 mm
REF4	10	White	63 mm

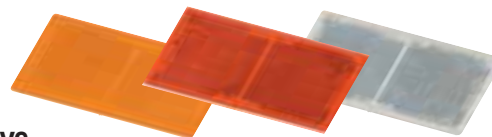

Self-Adhesive Rectangular Reflectors

Conforms to ECE E20.

Part No.	Pack of	Colour	Dimensions
REF7A	10	Red	103 x 50 mm
REF5A	10	Amber	103 x 50 mm
REF9A	10	White	103 x 50 mm



Reflective Triangle

EN 12899-3:2007.

Conforms to ECE E20. Screw-on type.

Part No.	Qty	Colour	Height
REF1S	2	Red	137 mm
REF1	10	Red	137 mm

Looking for LED Tail Lamps?

A complete range of LED Tail Lamps feature overleaf





4.5" LED Multifunction Tail Lamp - Stop/Tail/Indicator

IP67. Base material: ABS. Lens material: Acrylic. Bolt mounting.

• Includes Reflector

Part No.	Qty	Voltage	Lights	ECE Reg
EBT7058	1	12V	Stop/Tail/Ind	3/6/7

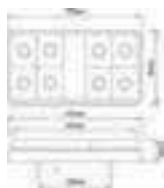

6" LED Multifunctional Tail Lamp - Stop/Tail/Indicator

IP67. Base material: ABS. Lens material: Acrylic. Bolt mounting.

• Includes Reflector

Part No.	Qty	Voltage	Lights	ECE Reg
EBT7060	Set of 2	10-30V	Stop/Tail/Ind	3/6/7



7.5" LED Multifunctional Tail Lamp - Stop/Tail/Indicator

IP67. Base material: ABS. Lens material: Acrylic. Bolt mounting.

• Includes Reflector

Part No.	Qty	Voltage	Lights	ECE Reg
EBT7069	1	12-24V	Stop/Tail/Ind	3/6/7



LED Multifunctional Tail Lamp - Stop/Tail/Indicator/Reverse

IP67. Base material: ABS housing. Lens material: Polycarbonate. Bolt mounting.

• Includes Reflector

Part No.	Qty	Voltage	Lights	ECE Reg
EBT7099	1	12-24V	Stop/Tail/Ind/Rev	3/6/7/23



BEST SELLER

COB LED Side Marker Lamp

IP65. EMC approved. Base material: ABS housing. Lens material: Polycarbonate. Bracket base fixing.

Part No.	Qty	Voltage	Colour	ECE Reg
EBT6095W	1	12-24V	White	3/7
EBT6095R	1	12-24V	Red	3/7
EBT6095A	1	12-24V	Amber	3/91

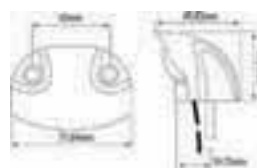

SMD LED Number Plate Lamp

IP67. Base material: ABS housing. Lens material: Polycarbonate. Surface mount fixing.

• Includes Reflector

Part No.	Qty	Voltage	Description	ECE Reg
EBT7085	1	10-30V	Number Plate Lamp	4

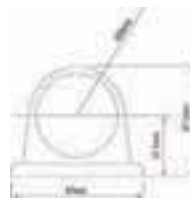

LED Rubber Marker Lamp

IP67. Base material: EPDM. Lens material: PMMA. Surface mount fixing.

Part No.	Qty	Voltage	Description	ECE Reg
EBT9711	1	12-24V	Rubber Marker Lamp Red 7/Clear 7	



LED Amber Warning Light - 3 x COB LED 8W

ECE Reg 10/65. IP67. Base material: ABS. Lens material: Polycarbonate. Bolt-on fixing. • 10 x Flash patterns

Part No.	Qty	Voltage	Width x Length
EBT6087	1	12-24V	33 x 89 mm





LED Adjustable Work Lamp - 6" Rectangular

IP67. EMC approved. Housing: Aluminium. Lens: Acrylic. Stainless steel mounting bracket

- 8 x High Performance LEDs
- 24 Watt/1680 Lumens
- Can be used as standard or side mount with swivel function

Part No.	Qty	Voltage	Description	ECE Reg
EBW6	1	12-28V	6" Adjustable	-

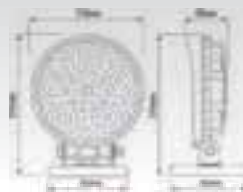

LED Magnetic Work Lamp - 4" Round

IP67. EMC approved. Housing: Aluminium. Lens: Acrylic. Supplied with 9.5M cable with switched in-vehicle adaptor.

- 6 x High Performance LEDs
- 18 Watt/1350 Lumens
- Magnetic Base
- Shock Resistant

Part No.	Qty	Voltage	Description	ECE Reg
EBW1	1	12-28V	4" Round	10



LED High Power Work Lamp - 4" Square

IP67. EMC approved. Housing: Aluminium. Lens: Acrylic. Stainless steel mounting bracket

- 16 x High Performance LEDs
- 48 Watt/3200 Lumens

Part No.	Qty	Voltage	Description	ECE Reg
EBW5	1	12-28V	4" Square	10

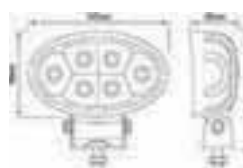

LED Work Lamp - 6" Oval

IP67. EMC approved. Housing: Aluminium. Lens: Polycarbonate. Stainless steel mounting bracket.

- 6 x High Performance LEDs
- 18 Watt/1350 Lumens

Part No.	Qty	Voltage	Description	ECE Reg
EBW3	1	12-28V	6" Oval	10



LED Work Lamp - 4" Square

IP67. EMC approved. Housing: Aluminium. Lens: Acrylic. Stainless steel mounting bracket

- 5 x High Performance LEDs
- 15 Watt/1050 Lumens

Part No.	Qty	Voltage	Description	ECE Reg
EBW2	1	12-28V	4" Square	10



LED Work Lamp - 5" Rectangular

IP67. EMC approved. Housing: Aluminium. Lens: Polycarbonate. Stainless steel mounting bracket.

- 6 x High Performance LEDs
- 18 Watt/1350 Lumens

Part No.	Qty	Voltage	Description	ECE Reg
EBW4	1	12-28V	5" Rectangular	10



NEW

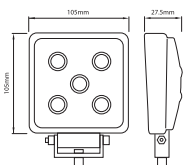

RING 15W LED Square Work Lamp - 105 mm

IP67. Certification: ECE R10. Cable length 300 mm. Housing: Thermoplastic. Lens: Polycarbonate.

- 750 Lumens
- 5 x 3W LEDs
- Lightweight

Part No.	Qty	Voltage	Description	ECE Reg
ERC9608	1	10-30V	105 mm Square	R10



NEW

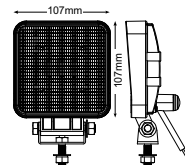

RING 15W LED Square Work Lamp with Switch

IP67. Certification: ECE R10. Cable length 300 mm. Housing: Aluminium. Lens: Polycarbonate.

- 5 x 3W LEDs
- Integrated switch
- Colour temperature: 5600K

Part No.	Qty	Voltage	Description	ECE Reg
ERC9607	1	10-30V	107 mm Square	R10

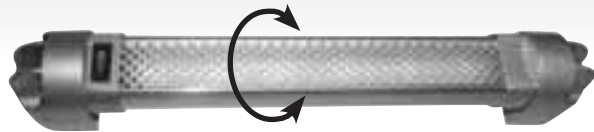

LED Interior Swivel Lamp - 6 x LED 6W

Lamp material: Aluminium. Lens material: Acrylic.
Supplied with stainless steel fixings and 400 mm cable.

- On/Off switch
- Lens swivels 180°

Part No.	Qty	Voltage	Depth x Length	Lumens
EBL330	1	12-24V	51 x 327 mm	600



LED Interior Lamp - 18 x SMD LED 3W

Lamp material: Aluminium. Lens material: Acrylic. Supplied with stainless steel fixings

- On/Off switch

Part No.	Qty	Voltage	Width x Length	Lumens
EBL270	1	12-24V	28 x 266 mm	380



LED Interior Lamp - 45 x SMD LED 6W

Lamp material: Aluminium. Lens material: Acrylic. Supplied with stainless steel fixings

- On/Off switch

Part No.	Qty	Voltage	Width x Length	Lumens
EBL570	1	12-24V	28 x 570 mm	900



RING 'TruckMaster' Baton LED Strip Light

Dimensions (H x W): 33 x 19 mm.

Part No.	Qty	DC Voltage	Width	Lumens
ERCV5012	1	12/24V	300 mm	400
ERCV5013	1	12/24V	600 mm	800



Metal-Halide Bulbs

Giant Edison screw cap (40 mm).

Dia x Length: 46 x 225 mm.

Provides 10,000 hours of "Day Light" (10 Years).

Part No.	Qty	Watts	Output	Cap
EMH250	1	250W	4200K	GES/E40
EMH400	1	400W	4200K	GES/E40



Metal-Halide Bulbs

Giant Edison screw cap (40 mm).

Dia x Length: 76 x 335 mm.

Provides 10,000 hours of "Day Light" (10 Years).

Suits VT-1 type tower lights.

Part No.	Qty	Watts	Output	Cap
EMH1000	1	1000W	4200K	GES/E40





LAP ELECTRICAL Halogen Rotating Beacon - DIN Pole Mount

IP56. Robust design. Reverse polarity protection.
-30°C to + 50°C extreme temperature reliability.
Takes H1 halogen bulb (NOT included).

Part No.	Qty	Colour	Voltage	ECE Reg
EBC104	1	Amber	12/24V	R65
ERC9420	1	DIN Pole		



LAP ELECTRICAL Halogen Rotating Beacon - 3 Point

IP56. Robust design.
Reverse polarity protection.
-30°C to + 50°C extreme temperature reliability.
Takes H1 halogen bulb (NOT included).

Part No.	Qty	Colour	Voltage	ECE Reg
EBC103	1	Amber	12/24V	R65



LAP ELECTRICAL Halogen Rotating Beacon - Flexi DIN Pole Mount

IP56. Robust design. Reverse polarity protection.
-30°C to + 50°C extreme temperature reliability.
Takes H1 halogen bulb (NOT included).

Part No.	Qty	Colour	Voltage	ECE Reg
EBC105	1	Amber	12/24V	R65
ERC9420	1	DIN Pole		



LAP ELECTRICAL Halogen Rotating Beacon - Magnetic Base

IP56. Robust design. Reverse polarity protection. -30°C to + 50°C extreme temperature reliability. Takes H1 halogen bulb (NOT included).

- 70 mph rated magnet

Part No.	Qty	Colour	Voltage	ECE Reg
EBC102	1	Amber	12/24V	R65



LAP ELECTRICAL Halogen Rotating Beacon - Single Point

IP56. Robust design. Reverse polarity protection.
-30°C to + 50°C extreme temperature reliability.
Takes H1 halogen bulb (NOT included).

Part No.	Qty	Colour	Voltage	ECE Reg
EBC101	1	Amber	12/24V	R65



Halogen Rotating Beacon - 3 Point

EMC approved (ECE R10). Reverse polarity protection.
-15°C to +40°C extreme temperature reliability. Maintenance free worm drive mechanism. Supplied with 12V and 24V H1 halogen bulbs.

- Ideal for Refuse Trucks, Agriculture Plant & Contracting

Part No.	Qty	Colour	Voltage	ECE Reg
EBC203	1	Amber	12/24V	R65



LED



RING 'Truck Master' LED Amber Mini Bar - Magnetic Mount

60 MPH speed rating. Reg 65 compliant. IP67 rated. 20 x programmable patterns. 2.4 m cable. In-vehicle power adaptor with flash and on/off switch included. Dimensions (H x W x D): 41 x 251 x 170 mm. 3 years warranty.

Part No.	Qty	DC Voltage	Watts
ERC9822	1	9-30V	40W



LED

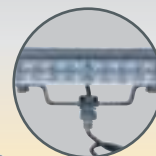

NEW



RING LED Amber Mini Lightbar Single Bolt Mount

Reg 65 compliant. IP67 rated. 40 x 1 W LED. 5 m cable. 3 years warranty.

Part No.	Qty	DC Voltage	Watts
ERC9761	1	10-30V	20W

LED



LED Rotating Beacon - Magnetic Base

IP65. EMC approved (ECE R10). Fully encapsulated electronics. 40 x LEDs. ABS base and polycarbonate lens.

- 40mph rated magnet
- 3 x Flash patterns - Simulated rotating, double flash and quad flash.

Part No.	Qty	Colour	Voltage	ECE Reg
EBC302	1	Amber	12/24V	R65

LED



LED Rotating Beacon - Flexi DIN Pole Mount

IP65. EMC approved (ECE R10). Fully encapsulated electronics. 40 x LEDs. ABS base and polycarbonate lens.

- 3 x Flash patterns - Simulated rotating, double flash and quad flash.

Part No.	Qty	Colour	Voltage	ECE Reg
EBC305	1	Amber	12/24V	R65
ERC9420	1	DIN Pole		

LED



LED Rotating Beacon - Single Point

IP65. EMC approved (ECE R10). Fully encapsulated electronics. 40 x LEDs. ABS base and polycarbonate lens.

- 3 x Flash patterns - Simulated rotating, double flash and quad flash.

Part No.	Qty	Colour	Voltage	ECE Reg
EBC301	1	Amber	12/24V	R65

LED



LED Rotating Beacon - 3 Point

IP65. EMC approved (ECE R10). Fully encapsulated electronics. 40 x LEDs. ABS base and polycarbonate lens.

- 3 x Flash patterns - Simulated rotating, double flash and quad flash.

Part No.	Qty	Colour	Voltage	ECE Reg
EBC303	1	Amber	12/24V	R65
EBC303G	1	Green	12/24V	R65





Hydraulic Steel Flat Face Coupling - Carrier (Female)

Meets the requirements of ISO 16028. Manufactured from high strength carbon steel with nitrile seal.

Part No.	Qty	BSP Thread	Bar	Body Size
HY301	1	1/4"	315	1/4" BSP
HY303	1	3/8"	250	3/8" BSP
HY305	1	1/2"	250	3/8" BSP
HY307	1	3/4"	250	1/2" BSP
HY309	1	1"	250	3/4" BSP



Hydraulic Quick Release Coupling - Carrier (Female)

Meets the requirements of ISO-7241-A. Manufactured from high strength carbon steel.

- Rugged construction
- Ideal for construction equipment, manufacturing machinery and in-plant systems

Part No.	Qty	BSP Thread	Max Work Pressure	Size
HY402	1	1/4"	350 Bar	04SF
HY406	1	3/8"	315 Bar	06SF
HY400	1	1/2"	250 Bar	08SF
HY404	1	3/4"	250 Bar	12SF
HY408	1	1"	230 Bar	16SF



Hydraulic Steel Flat Face Plug - Probe (Male)

Meets the requirements of ISO 16028. Manufactured from high strength carbon steel.

Part No.	Qty	BSP Thread	Bar	Body Size
HY300	1	1/4"	315	1/4" BSP
HY302	1	3/8"	250	3/8" BSP
HY304	1	1/2"	250	3/8" BSP
HY306	1	3/4"	250	1/2" BSP
HY308	1	1"	250	3/4" BSP



Hydraulic Quick Release Coupling - Probe (Male)

Meets the requirements of ISO-7241-A. Manufactured from high strength carbon steel.

- Rugged construction
- Ideal for construction equipment, manufacturing machinery and in-plant systems

Part No.	Qty	BSP Thread	Max Work Pressure	Size
HY403	1	1/4"	350 Bar	04SF
HY407	1	3/8"	315 Bar	06SF
HY401	1	1/2"	250 Bar	08SF
HY405	1	3/4"	250 Bar	12SF
HY409	1	1"	230 Bar	16SF



Hydraulic BSPP Swivel Adaptor - Female : Female

Part No.	Qty	Type	BSP Thread
HY156	2	F : F	1/4" : 1/4"
HY155	2	F : F	1/4" : 3/8"
HY154	2	F : F	3/8" : 3/8"
HY153	2	F : F	3/8" : 1/2"
HY152	2	F : F	1/2" : 1/2"
HY151	1	F : F	3/4" : 3/4"
HY150	1	F : F	1" : 1"



Hydraulic BSPP Swivel Adaptor - Male : Female

Part No.	Qty	Type	BSP Thread
HY135	2	M : F	1/4" : 3/8"
HY138	2	M : F	3/8" : 1/4"
HY136	2	M : F	3/8" : 3/8"
HY131	2	M : F	3/8" : 1/2"
HY137	2	M : F	5/8" : 5/8"
HY133	2	M : F	1/2" : 3/8"
HY134	2	M : F	1/2" : 1/2"
HY130	1	M : F	1/2" : 3/4"
HY132	1	M : F	3/4" : 1/2"



Looking for Breaker Hose Sets?

Our full range can be found on Page 284

Hydraulic BSPP/BSPT Adaptor - Male : Male

Part No.	Qty	Type	BSPP : BSPT Thread
HY102	5	M : M	1/4" : 1/4"
HY100	5	M : M	3/8" : 1/4"
HY101	5	M : M	3/8" : 1/2"
HY103	2	M : M	1/2" : 1/2"



Hydraulic BSPP Adaptor - Male : Male

Part No.	Qty	Type	BSPP Thread
HY115	5	M : M	1/4" : 1/4"
HY114	5	M : M	1/4" : 3/8"
HY121	5	M : M	3/8" : 3/8"
HY117	5	M : M	3/8" : 1/2"
HY118	5	M : M	1/2" : 1/2"
HY112	2	M : M	1/2" : 5/8"
HY120	2	M : M	1/2" : 3/4"
HY116	2	M : M	5/8" : 5/8"
HY119	2	M : M	3/4" : 3/4"
HY111	1	M : M	1" : 1/2"
HY110	1	M : M	1" : 3/4"
HY113	1	M : M	1" : 1"



Hydraulic BSPP Bulkhead Fitting

Part No.	Qty	BSPP Thread
HY161	1	3/8"
HY160	1	1/2"



Hydraulic BSPP Blanking Plug

Part No.	Qty	BSPP Thread
HY173	5	1/4"
HY172	5	3/8"
HY171	2	5/8"
HY170	1	1"



Hydraulic BSPP Equal Elbows - F : F

Part No.	Qty	Type	BSPP Thread
HY202	2	F : F	3/8"
HY204	1	F : F	1/2"



Hydraulic BSPP Equal Elbows - M : F

Part No.	Qty	Type	BSPP Thread
HY201	2	M : F	3/8"
HY203	1	M : F	1/2"



Hydraulic BSPP Equal Elbows - M : M

Part No.	Qty	Type	BSPP Thread
HY200	1	M : M	3/8"



Hydraulic BSPP Equal Tee - Female

Part No.	Qty	BSPP Thread
HY190	1	3/8"
HY191	1	1/2"



Hydraulic BSPP Blanking Cap

Part No.	Qty	BSPP Thread
HY180	5	1/4"
HY181	5	3/8"
HY182	5	1/2"
HY183	2	5/8"
HY184	1	1"





1/2" BSP Hydraulic Breaker Hose Sets - 6 m

EN 857 2SC - SAE 100 R16S. Working Pressure: 275 bar/4000 PSI.

Part No.	Qty	Fittings
HY10	1	Male & Female Couplings
HY13	1	1/2" BSP Male Ends



1/2" BSP Hydraulic Breaker Hose Tails - 18"

EN 857 2SC - SAE 100 R16S. Working Pressure: 275 bar/4000 PSI.

Part No.	Set of	Fittings
HY11	2	Male/Female Couplings
HY12	2	1/2" BSP Male Ends



Compressor Air Hose Assembly

20 bar/300 PSI high quality rubber hose. Complete with brass claw fitting safety couplings.

Part No.	Qty	Size	Length
AL500	1 Coil	3/4"	15 m

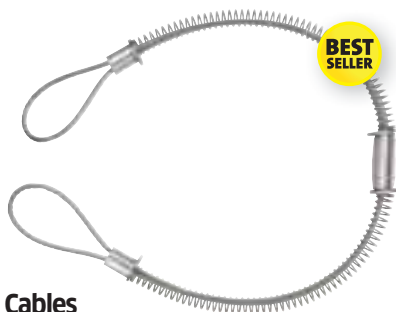

Whip Check Cables

Steel cable and plated springs.

Part No.	Qty	Cable Diameter	Suits Hose Diameter	Length
AL90	1	1/8"	1/2" to 1 1/4" (Small)	540 mm
AL91	1	1/4"	1 1/2" to 3" (Large)	970 mm



FUCHS 'Renolin' ZAF 46 HV High Quality Hydraulic & Lubricating Oil

High viscosity index, zinc and ash free hydraulic oil.

- Ideal for powering hydraulic systems working in refrigerated plant, mobile equipment, or where the system demands a fluid capable of working over a wide temperature range.

Part No.	Qty	Size
VC117	1	20 Litres



FUCHS 'Agrifarm' Universal 2-stroke Oil

Specifications: API, TC, JASO, FB.

Suitable for use in all 2-stroke engines. May be used either as a tank mix or in oil injection systems. Dyed red for ease of identification.

- Ideal for agricultural and horticultural machinery, chain saws, hedge cutters, strimmers, portable generators, etc.

Part No.	Qty	Size
VC116	1	20 Litres



FUCHS 'Titan Truck Plus' 15W-40 Oil

Specifications: ACEA E7, API CI-4/SL, GLOBAL DHD-1, CAT ECF-1-a/ECF-2.

A super long term all season engine oil of the SHPD category for diesel and gasoline engines with and without turbo charging in passenger cars, trucks, buses and industrial equipment

- Excellent wear protection even under high continuous stress
- Protection from corrosion even when used with diesel fuels with high sulphur content

Part No.	Qty	Size
VC115A	1	5 Litres
VC115	1	20 Litres



ROCK OIL ISO-32 Hydraulic Oil

Meets DIN 51525 and
DIN 51524 Parts 1 & 2.

- Excellent protection of machinery and systems against corrosion and wear.
- * NOT to be used as Brake Fluid.

Part No.	Qty	Size
VC199	1	20 Litres



KOLOR KUT Water Finding Paste

A golden brown colour which turns brilliant red upon contact with water. Can be used to successfully gauge water content in all petrol and hydrocarbons.

Part No.	Pack of	Size
VC752	1	85g Tube

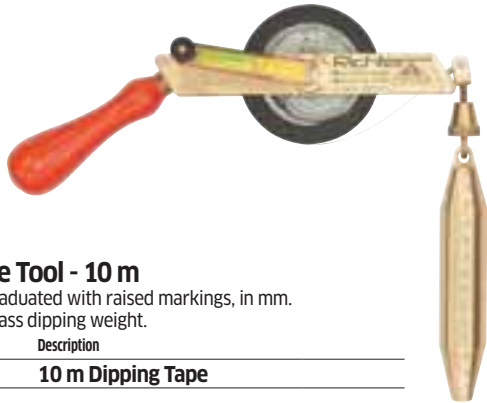

RICHTER Dipping Tape Tool - 10 m

Mild steel tape graduated with raised markings, in mm. Complete with brass dipping weight.

Part No.	Qty	Description
VC750	1	10 m Dipping Tape



Water Finding Strips

A golden brown colour which turns brilliant red upon contact with water. Can be used to successfully gauge water content in all petrol and hydrocarbons.

Part No.	Tub of	Description
VC751	200	Dip Strips



NGK Spark Plugs

Seat type: Flat.
Tip configuration: Non projected.
Construction: Special design.
Terminal type: Solid.

3.75 mm	Box of	NGK Ref.
PG1	10	B2LM
PG2	10	B4LM
PG3	10	B5HS
PG4	10	B6HS
PG5	10	BCPR5ES
PG6	10	BCPR6ES
PG7	10	BKR5E
PG8	10	BM6A
PG9	10	BMR4A
PG10	10	BMR6A
PG12	10	BMR7A
PG13	10	BP5ES
PG14	10	BP6ES
PG15	10	BPM6A
PG16	10	BPM7A
PG17	10	BPMR4A
PG18	10	BPMR6A
PG19	10	BPMR7A
PG20	10	BPR6HS
PG21	10	BPR5ES
PG22	10	BPR5HS
PG23	10	BPR6ES
PG24	4	BR10EIX
PG25	10	BR2LM
PG26	10	BR4HS
PG27	10	BR4LM
PG28	10	BR5ES
PG29	10	BR5HS
PG30	10	BR6HS
PG31	10	CM6
PG32	10	CMR6H
PG33	10	CR4HSB
PG35	10	CR5HSB



CreteBeater

Non-Toxic

Non-Corrosive

CreteBeater®

The environmentally friendly foam for removing concrete and cement safely and effectively without damaging the surface of vehicles, tools, equipment, machinery and other surfaces

CreteBeater®

Dissolves concrete by breaking down the bond of cement, making concrete layers bubble up and release from the surface

CreteBeater®

Originally developed for use by the ready-mix concrete supply industry



CreteBeater®

NEW



CreteBeater 'Civil Engineering' Heavy Duty Concrete Remover

100% biodegradable and designed to safely remove cement and concrete by dissolving it in a bio-safe way. Does not contain muriatic, phosphoric or citric acids and is therefore, non-corrosive.

Safe to use on:

- Painted surfaces/vehicles
- Aluminium
- Glass/Windows
- Rubber/Tyres/Hoses
- Human Handling

Part No.	Qty	Pack Size
CB20	1	20 Litre Container

ALTA Foam Pressure Sprayer

Contains FPM VITON® (FKM) seals. Special lance produces a rich foam to help dissolve/degrease dirt. Suitable for use with S-A-S Snow Foam (Part No. SAS2017).

- High foaming action spray

Part No.	Qty	Capacity
CAN27	1	1.8 Litre



ALTA Foam Pressure Sprayer

Contains FPM VITON® (FKM) seals. Supplied with 3 x interchangeable nozzles to adjust the foam thickness. Suitable for use with S-A-S Snow Foam (Part No. SAS2017).

- High foaming action spray
- Lance with 120 cm long hose

Part No.	Qty	Working Capacity
CAN28	1	6.0 Litre



In 3 simple steps!

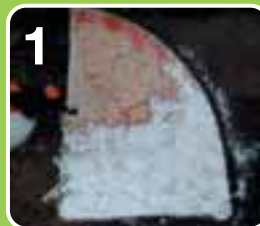

1 Apply CreteBeater as a foam making sure the surface is covered and saturated



2 Infuse for 20-45 minutes ensuring area remains wet (especially in hot conditions)*



3 Rinse off using pressure washer or water and brush for detailing



288



289



289



290



292



294



Grease + Chemicals



296



297



298

- 288 Additives
- 289 AdBlue®
- 289 Screen Wash
- 290 Ice + Snow Removal
- 291 Valeting
- 298 Servicing
- 300 Cleaning
- 302 Grease Nipples
- 303 Grease Guns
- 304 Grease
- 306 Plant Machinery Oils
- 307 Lubricants + Maintenance
- 311 Rust Treatment
- 312 Metal Protection Sprays
- 313 Primers
- 314 Paints
- 316 Paint Rollers
- 317 Paint Brushes
- 318 Assortment Sprays



300

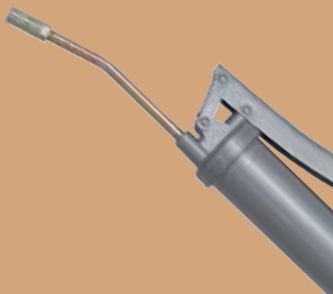

303



305



307



309



312



315



317



SAS

S-A-S Diesel Fuel Treatment

Improves engine performance. Lubricates and extends life if injectors and fuel pumps. Compatible with catalytic converters and particulate traps.

Reduces Exhaust Emissions

Part No.	Qty	Size
SAS701	1	300ml Bottle
SAS701/12	12	300ml Bottles



SAS

S-A-S Petrol Fuel Treatment

Improves engine performance. Neutralises acids and improves fuel economy. Compatible with catalytic converters and engine sensors.

Reduces Exhaust Emissions

Part No.	Qty	Size
SAS702	1	300ml Bottle
SAS702/12	12	300ml Bottles



SAS

S-A-S Engine Flush

Advanced formulation. Helps prolong the life of new engine oil. Removes sludge, lacquer and varnish from all lubrication faces.

Part No.	Qty	Size
SAS703	1	300ml Bottle
SAS703/12	12	300ml Bottles



STP

STP Engine Flush

Suitable for petrol and diesel engines. Add directly to used motor oil before each oil change.

- Removes harmful sludge and deposits.
- Contains an anti-wear additive to help protect engine surfaces.

Part No.	Qty	Size
VC151	1	450ml Bottle



STP

STP Diesel Injector Cleaner

A high strength, super concentrated cleaner specially formulated to remove power-robbing deposits from all fuel injection systems. Cleans clogged injectors in just one tankful. Compatible with catalytic converters.

- Restore power and acceleration.
- Smooth out rough idling.
- Clean and condition fuel delivery system.
- Increase fuel economy.
- Reduce exhaust emissions.

Part No.	Qty	Size
VC153	1	200ml Bottle

BEST SELLER



STP

STP Petrol Injector Cleaner

A high strength, super concentrated cleaner specially formulated to remove power-robbing deposits from all fuel injection systems. Cleans clogged injectors in just one tankful. Compatible with catalytic converters.

- Restore power and acceleration.
- Smooth out rough idling.
- Clean and condition fuel delivery system.
- Increase fuel economy.
- Reduce exhaust emissions.

Part No.	Qty	Size
VC152	1	200ml Bottle



NEW

BAR'S Radiator Stop Leak

Specially designed to stop emergency cooling system leaks and drips and reduce or eliminate cavitation.

- Stops and prevents internal and external leaks up to 0.9 mm in size
- Freely recirculates to prevent future leaks
- Buffing agents keep system clean - will not clog
- Compatible with all antifreeze brands

Part No.	Qty	Size
VC230N	10	200ml Bottles



CE-LIT Radiator Cement

Cures all leaky radiators, cylinder blocks and water pumps, etc. even when used with anti-freeze.

- For Cars, Trucks and Tractors.

Part No.	Qty	Description
DC70	1	Display Card of 24 Sachets



CHEMICO Grinding Paste

Silicone carbide and lithium based grease. Double-ended tin of Coarse and Fine paste.

- A handy supply of a Coarse paste to cut and a Fine paste to finish.
- It has inherent shear stability, corrosion protection and good sealing properties.

Part No.	Pack of	Size
GLU13	4	110g Tin



Valve Grinding Sticks

Double ended suction cup.

Part No.	Pack of	Description
TL882A	2	Valve Grinding Sticks





GRANVILLE Brake & Clutch Fluid

DOT 4.

Part No.	Qty	Size
VC165	1	5 Litre Container



AdBlue® Plastic Delivery Nozzle

- 19 mm Spout
- 3/4" BSP

Part No.	Qty	Description
ADB301	1	Delivery Nozzle

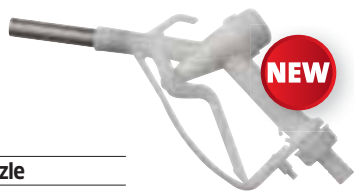

AdBlue® Gravity Hose Kit

Self assembly.

Part No.	Qty	Length
ADB302	1	3 m Hose



AdBlue® Solution

ISO 22241. Suits all Euro 4/5/6 diesel engines.
For AdBlue® diesel vehicles, ready to use.
32.5% solution of pure urea in demineralised water.

- Freezing point of -11°C
- Pouring spout included

Part No.	Qty	Size
ADB10	1	10 Litres
ADB20	1	20 Litres
ADB205*	4	210 Litres

* Please allow 5-7 days delivery on this product.



ARDINA Screen Wash 1:100 Concentrate

Highly concentrated screenwash which removes dirt, water spots and insects. Leaves a pleasant smell and a streak free finish.

- Highly concentrated product: 1 bottle makes 3 litres

Part No.	Box of	Size
DSL62	25	32ml Bottles



SAS

S-A-S Concentrated Screen Wash

Designed with powerful detergents and an anti-freeze agent to prevent washer jets freezing in the wintertime, and to clear summer fly squash.

- Lowest working temperature: -7.6°C.

Part No.	Pack of	Size
SAS1060/2	2	5 Litre Containers



CLEARALEX Concentrated Screen Wash

Designed with powerful detergents and an anti-freeze agent to prevent washer jets freezing in the wintertime, and to clear summer fly squash.

- Lowest working temperature: -7.6°C.

Part No.	Pack of	Size
DSL60	2	5 Litre Containers



DECOSOL Ready Mix Screen Wash

Pour into the washer bottle and go!
Highly concentrated formula,
cleans without smearing.

Part No.	Pack of	Size
DSL21N	2	5 Litre Containers





Extending Shovel

Aluminium with heavy duty nylon head and handle.

Part No.	Qty	Description
TL8020	1	Extending Shovel



5" Heavy Duty Ice Scraper

• Soft foam grip handle

Part No.	Qty	Description
TL8021	1	Ice Scraper



3-in-1 Ice Scraper

Part No.	Qty	Description
TL8022	1	Ice Scraper with Squeegee



DECOSOL Power De-icer

High strength formula quickly removes frost and ice from windows and windscreens. Highly concentrated to prevent refreezing.

Part No.	Pack of	Size
DSL31	6	750ml Sprayers



NILCO 'Nilglass' Glass & Mirror Cleaner

Britain's leading commercial glass cleaner. For use on all water resistant hard nonporous substrates, particularly glass and other reflective surfaces for light duty cleaning.

Part No.	Pack of	Size
NIL1	6	1 Litre Trigger Sprays
NIL5	2	5 Litre Containers



DECOSOL Glass Cleaner

High performance glass and mirror cleaner leaves a streak-free surface both inside and out. Will not harm rubber and plastics. Removes insect smear, road & traffic film, nicotine and finger prints.

Part No.	Pack of	Size
DSL40	6	750ml Sprayers

SAS



S-A-S Assorted Pack - Valeting Aerosols 500ml

A selection of professional quality valeting aerosols, providing a clean finish for all vehicles. Plus the No.1 selling Universal Maintenance Lubricant, ideal for everyday maintenance applications.

Part No.	Qty
SASV	Set of 6

6 x 500ml Aerosols: Glass Cleaner, Cockpit Spray, Tyre Foam, Multi Purpose Foam Cleaner, Air Duster, Universal Maintenance Lubricant.

SAS

S-A-S Glass Cleaner

- Cleans Glass, Ceramics, Perspex and any hard surfaces.
- Can be used as a Telephone Cleaner (spray onto cloth before use).
- Silicone Free.

Part No.	Pack of	Size
SAS16	6	500ml Aerosols



DECOSOL 'Instant Valay' Foam Upholstery Cleaner

Award winning foam cleaner.

Fast acting, effective foam cleaner, which safely and gently lifts dirt from fabric, upholstery, vinyl and most interior fitments, including carpets and floor mats.

Part No.	Pack of	Size
DLS50	12	500ml Aerosols

SAS

S-A-S Multi-Purpose Foam Cleaner

Use on Upholstery, Curtains, Fabrics and Hard Surfaces; e.g. Computer Casings, Office Furniture.

- Instant foaming action lifts dirt.
- Easily wiped away.
- Removes nicotine stains.
- Anti-static formula when used with non static cloth (i.e. microfibre).
- Ideal for use in Offices, Cars and Public Service Vehicles.

Part No.	Pack of	Size
SAS32	6	500ml Aerosols

SAS

S-A-S Air Duster

High pressure compressed air.

- Ideal for use on Vehicle Dashboards, Electronic Equipment, Delicate Instruments, Hi-Fi Equipment, Computer Keyboards, etc.
- When sprayed upside down acts as a freeze spray which can remove Chewing Gum.

Part No.	Pack of	Size
SAS54	6	500ml Aerosols

BEST SELLER



BEST SELLER



SAS

S-A-S Air Con Sanitiser

Each aerosol provides up to 4 sanitising applications

- Highly effective natural formulation.
- Eliminates odours from air con and heating systems.
- Leaves system fresh and germ free for months.
- Complete with specially designed wide-spray extension.

Part No.	Pack of	Size
SAS55	6	500ml Aerosols



SAS

S-A-S Cockpit Spray

Restores sheen to any hard surface

- Enhances appearance of plastics, vinyl and rubber.
- Suitable for Public Service Vehicles as a protective coating against soiling.
- Acts as a plasticiser.
- Contains Silicone.

Part No.	Pack of	Size
SAS15	6	500ml Aerosols

BEST SELLER



SAS

S-A-S Multi Shine

Designed for use in body shops or adjacent to paint spray areas.

- A Silicone FREE alternative to 'Cockpit Shine'.
- Gives an attractive, satin sheen to surfaces.
- Ideal for Matt finish dashboard/interiors.

Part No.	Pack of	Size
SAS51	6	500ml Aerosols



SAS

S-A-S Tyre Foam

Wash vehicle, spray on and leave for shine to develop.

- Suitable for all types of tyre on any vehicle.
- Contains Silicone.

Part No.	Pack of	Size
SAS43	6	500ml Aerosols



SAS

S-A-S Pre-Wash Snow Foam

Highly concentrated, high foaming, powerful cleaning formula. Safe to use on all types of paintwork and a great way to prepare your vehicle for washing.

- **Highly concentrated** - dilute to a ratio of 9 parts water to 1 part product
- **pH neutral formula breaks down excess dirt, dust, and grime** to leave behind a prepped surface for washing
- **Multi-Purpose Application** - can be used with a foam gun, pressure washer foam lance and through a pump sprayer

Part No.	Qty	Description
SAS2517A	1	500ml Bottle



SAS

S-A-S Car Care Shampoo

A luxurious, high concentration car shampoo. With a dilution ratio of 1900:1 - only 12ml cleans an average sized car.

- **Dilution ratio of 1900:1**
- **High foaming lubrication prevents scratching paintwork**
- **Fully compatible with all types of waxes, sealants and ceramic coatings**

Part No.	Qty	Description
SAS2511A	1	500ml Pump Dispenser



SAS

S-A-S Concentrated Wash & Wax

A concentrated shampoo and wax that's strong enough to cut through dirt and road film, while gentle enough not to harm the existing layer of protection on your car.

- **Cleans, shines and protects in one easy step**
- **Between 1:400 and 1:800 dilution ratio** - add 2 caps to every 10 litres of water
- **Special lubricants and waxes provide a smooth glide feel** between your wash media and the paint surface
- **Protects paintwork**

Part No.	Qty	Description
SAS2545A	1	500ml Bottle



SAS

S-A-S Alloy Wheel Cleaner

Offers a deep rich clean to your vehicle's wheels, without damaging your sealants.

- **Acid-free**
- **pH neutral**
- **Safe for use on all types of alloy wheels**
- **Tough on dirt but gentle on paint**

Part No.	Qty	Description
SAS2506A	1	500ml Trigger Spray



SAS

S-A-S Glass Cleaner

Specially formulated to be safe to use on tinted glass, it leaves behind a streak-free finish and hydrophobic protection.

- **Cleans all glass, mirrored surfaces, lights and chrome trims**

Part No.	Qty	Description
SAS2516A	1	500ml Trigger Spray



SAS

S-A-S Cockpit & Trim Shine

Provides the perfect finish to all plastics, rubber trims and tyres leaving behind a protective barrier that is resistant to road debris.

- **Fast drying**
- **Leaves a protective gloss coating**
- **Highly resistant to road debris**

Part No.	Qty	Description
SAS2515A	1	500ml Trigger Spray



SAS

S-A-S Multi Purpose Cleaner

A professional, solvent-free, multi-purpose cleaner designed to clean all exterior and interior automotive surface materials quickly and safely.

- **Highly effective on all hard and soft surfaces**
- **Designed for undercarriages, door shuts and engine bay cleaning**
- **Breaks down grease and dirt with ease making it ideal for hard to reach places**

Part No.	Qty	Description
SAS2510A	1	500ml Trigger Spray



SAS

S-A-S Tyre Shine Gel

High gloss tyre sealant. Containing high grade silicone and white oil - leaves tyres looking replenished and new. This highly effective, long lasting formula will protect your tyre wall from cracking and browning.

- **Long lasting formula**
- **Leaves tyres looking as good as new**
- **Protects tyre wall from cracking and browning**

Part No.	Qty	Description
SAS2543A	1	500ml Flip Top Bottle



SAS

S-A-S Heavy Cutting Paste (Stage 1 of 3)

The first of three stages of cutting compounds. Designed as an aggressive stage of polishing. It will remove scratches of 1200 grit sandpaper and swirl marks with ease, preparing for our Medium Cutting Paste.

- Formulated with high cutting abrasives and fillers
- Contains kaolin clays to help refine, restore and cleanse your vehicle's paintwork

Part No.	Qty	Description
SAS2501A	1	500ml Flip Top Bottle



SAS

S-A-S Medium Cutting Paste (Stage 2 of 3)

The second of three stages of cutting compounds. Formulated with diminishing abrasive chemistry. This means the particles of abrasive start off large, getting smaller the more you work with them - in effect lowering the cutting power over time.

- Refines, restores and cleanses vehicle paintwork
- Contains the highest grade of fillers and kaolin clays
- Helps to even out the deeper cuts of our Heavy Cutting Paste in preparation for our Fine Cutting Paste

Part No.	Qty	Description
SAS2502A	1	500ml Flip Top Bottle



SAS

S-A-S Fine Cutting Paste (Stage 3 of 3)

The final of three stages of cutting compounds. Formulated with diminishing abrasive chemistry. This means the abrasive particles get smaller the more they are worked into the paintwork. This effectively means the cutting power of the compound reduces whilst you're using it, offering a more even and gradual application.

- Contains the highest grade of fillers and kaolin clays
- Refines and cleanses your vehicle's paintwork
- Designed as the final stage of polishing

Part No.	Qty	Description
SAS2503A	1	500ml Flip Top Bottle



SAS

S-A-S High Gloss Polish

All-in-one wax and polish. Essential for any detailing enthusiast. Contains special abrasives and fillers to help remove paintwork defects.

- Infused with the finest grade Brazilian carnauba wax
- Long term protection
- High-gloss finish
- Protects against road debris
- UV protection

Part No.	Qty	Description
SAS2508A	1	500ml Pump Dispenser



SAS



S-A-S Detailing Pack - Exterior

Part No.	Qty	Description
SASVP1	Set of 6	Exterior Pack
2 x 500ml Pre-Wash Snow Foam, 500ml Concentrated Wash & Wax, 1 x 500ml Care Care Shampoo, 500ml Alloy Wheel Cleaner		

SAS



S-A-S Detailing Pack - Interior/Exterior

Part No.	Qty	Description
SASVP2	Set of 6	Interior/Exterior Pack
2 x 500ml Glass Cleaner, 500ml Cockpit & Trim Shine, 1 x 500ml Multi Purpose Cleaner, 500ml Tyre Shine Gel		

SAS



S-A-S Detailing Pack - Exterior Polish

Part No.	Qty	Description
SASVP3	Set of 6	Exterior Polish Pack
2 x 500ml High Gloss Polish, 500ml Fine Cutting Paste, 1 x 500ml Medium Cutting Paste, 500ml Heavy Cutting Paste		



SAS

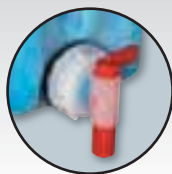

S-A-S Glass Cleaner

Supplied in a stackable UN container.

- **Advanced Silicone Free Formula** - Rapid evaporation provides a streak-free finish
- **Highly Effective Cleaning Power** - Quickly removes dirt, grease and bird droppings on windows, mirrors, plastic, vinyl & hard surfaces

Part No.	Qty	Size
SAS2016	1	5 Litre Container
SAS2000T	1	5 Litre Dispenser Tap

SAS



S-A-S Silicone Tyre Dressing

Supplied in a stackable UN container.

- **Makes Tyres Look Like New** - Advanced silicone based formula returns tyres back to a slick black sheen
- **Quick & Easy Application** - Simply spray on and wipe
- **Contains Silicone**

Part No.	Qty	Size
SAS2043	1	5 Litre Container

SAS



S-A-S Satin Finish Cockpit Shine

Supplied in a stackable UN container.

- **Advanced Silicone Free Polymer Formula** - Long lasting satin finish that repels soiling & staining
- **Protects All Things Rubber & Plastic** - Use on internal & external plastic, vinyl and rubber trims & finishes to prevent drying, fading & cracking

Part No.	Qty	Size
SAS2015	1	5 Litre Container

SAS



Turns Red-Purple During Cleaning



S-A-S Alloy Wheel Cleaner

Supplied in a stackable UN container.

- **High Performance Formulation** - Dissolves brake dust and other iron-rich contaminants
- **Safe On All Wheel Types** - Effectively cleans all types of wheel finish including highly polished and anodised aluminium

Part No.	Qty	Size
SAS2041	1	5 Litre Container

SAS



S-A-S Leather Cleaner

Supplied in a stackable UN container.

- **Powerful 3-in-1 Formula** - Cleans, rejuvenates and conditions
- **pH Balanced** - Helps to prolong leather life

Part No.	Qty	Size
SAS2033	1	5 Litre Container

SAS



S-A-S Tar & Gum Remover

Supplied in a stackable UN container.

- **Extremely Strong Formula** - Instantly dissolves tar & gum on paintwork & plastics
- **Multi-Purpose Application** - Can also be used to remove oil, grease, fuel stains, wax, silicone & adhesive residue

Part No.	Qty	Size
SAS2058	1	5 Litre Container

SAS



S-A-S Concentrated Carpet Shampoo

- **Concentrated Formulation** - Dilute to remove light soiling or use neat to remove heavy soiling on all carpets
- **Powerful Cleaning Action** - Unique formula breaks down oil & grease for quick & easy cleaning of porous materials

Part No.	Qty	Size
SAS2132	1	1 Litre Bottle

ALTA Foam Pressure Sprayer

Contains FPM VITON® (FKM) seals. Supplied with 3 x interchangeable nozzles to adjust the foam thickness. Suitable for use with S-A-S Snow Foam (Part No. SAS2017).

- **High foaming action spray**
- **Lance with 120 cm long hose**

Part No.	Qty	Working Capacity
CAN28	1	6.0 Litre



SAS



S-A-S Pre-Wash Snow Foam

Supplied in a stackable UN container.
Dilute 100/150ml per car.

- **Biodegradable Free Formula** - Safely and efficiently lifts dirt and grime without stripping sealant or wax protection
- **Multi-Purpose Application** - Can be used with a foam gun, pressure washer foam lance and through a pump sprayer

Part No.	Qty	Size
SAS2017	1	5 Litre Container
CAN27	1	Foam Pressure Sprayer 1.8 Litre



SAS

S-A-S Highly Concentrated Vehicle Shampoo

Supplied in a stackable UN container.
Dilution ratio: 1900:1.

- **Paintwork Protection Formula** - Special lubricants cuts through tough dirt and grime that is gentle enough to protect existing paint layer
- **Highly Concentrated Formula** - Very economical dilution ratio 1900 water : 1 solution

Part No.	Qty	Size
SAS2011	1	5 Litre Container



SAS

S-A-S Concentrated Wash & Wax

Supplied in a stackable UN container.
Dilution ratio: Between 1:400 and 1:800.

- **Paint Protection Formula** - Special lubricants cuts through tough dirt and grime that is gentle enough to protect existing paint layer
- **Leaves A Long Lasting Shine** - Waxes provide a glossy paint protection finish that leaves vehicles clean and shiny for weeks

Part No.	Qty	Size
SAS2045	1	5 Litre Container



SAS

S-A-S Hydrophobic Paint Guard

Supplied in a stackable UN container.

- **Long Lasting Hydrophobic Guard** - A unique sealant provides protection from bird droppings, bugs and road salts
- **Multi-Purpose Application** - Can be used all over vehicles: Coating paintwork, glass, alloy wheels, steel, plastics and rubbers

Part No.	Qty	Size
SAS2021	1	5 Litre Container



SAS

S-A-S Concentrated Traffic Film Remover

Supplied in a stackable UN container.
Dilution ratio: 1:50.

- **Heavy Duty Formula** - Contains sodium hydroxide for effortless cleaning
- **Multi-Purpose Application** - Can be used with a foam gun, pressure washer foam lance and through a pump sprayer

Part No.	Qty	Size
SAS2040	1	5 Litre Container



SAS

S-A-S Waterless Wash & Wax

Supplied in a stackable UN container.

- **Cleans Without Rinsing With Water** - The unique formula ensures dirt particles are encapsulated providing a scratch free clean
- **Professional Wax Finish** - Contains Carnauba wax for a durable long lasting protection with an outstanding glossy shine
- **Contains Silicone**

Part No.	Qty	Size
SAS2022	1	5 Litre Container



SAS

S-A-S Wax Spray

Supplied in a stackable UN container.

- **Temperature Insensitive Formula** - Quickly provides a thin protective coating of Carnauba wax & gloss enhancing polymers
- **Professional Streak Free Finish** - Produces a durable long lasting protection with an outstanding ultra-slick glossy shine
- **Contains Silicone**

Part No.	Qty	Size
SAS2046	1	5 Litre Container



SAS

S-A-S Odour Eliminator

Supplied in a stackable UN container.

- **Complete Odour Control Formula** - Captures, breaks down and kills unpleasant odours
- **Perfume Free Fresh Fragrance** - Removes unwanted smells caused by smoke, damp, pets and traffic fumes leaving it smelling fresh & clean

Part No.	Qty	Size
SAS2034	1	5 Litre Container





BEST SELLER

NILCO 'Power Fresh' Air Fresheners

'Power Blast' aerosol provides high volume burst of fragrance. For industrial or janitorial applications. Helps eliminates odours in large areas.

Ideal for:

- PSVs.
- Meeting Rooms.
- Refuse Areas.
- Conference Halls.
- Warehouses.
- Changing Rooms & Toilets.

Part No.	Qty	Fragrance	Size
NIL605	1	Spring	750ml Aerosol
NIL606	1	Cranberry	750ml Aerosol
NIL607	1	Lavender	750ml Aerosol

Part No.	Description
AP63	Assorted Pack of 3 1 x Spring, 1 x Cranberry, 1 x Lavender.



LITTLE TREES Air Fresheners - 'Black Ice'

The original 'MAGIC TREE'. Men's cologne fragrance. • Ideal for inconspicuous use on black car interiors.

Part No.	Box of	Description
VC663	24	Black Ice



LITTLE TREES Air Fresheners

The original 'MAGIC TREE'. Assorted Fragrances

Part No.	Qty	Description
VC660	Box of 24	Display Box



NEW

Wheel Brush

- Specially designed super soft flexible bristles
- Cleans all hard to reach areas
- Pro-grade, non-scratch safety tip

Part No.	Qty	Description
WB20	1	Wheel Brush



LISTER Vehicle Wash Brush - Industrial Size

Nylon bristles with Hose Fitting. For use on Vans, Coaches, Trucks, Caravans, etc.

Part No.	Qty	Description
WB91	1	Industrial Size Brush



LISTER Extension Handles for Vehicle Wash Brushes

Compatible with Part No.s WB91, WB94. (Brush head NOT included).

Part No.	Qty	Length
WB93	1	3 ft
WB96	1	6 ft



BEST SELLER



Telescopic Wash Brush

Soft bristles with flow-through handle. Length: 100 cm closed, extends to 170 cm (5 ft 8").

Part No.	Qty	Description
WB90	1	Telescopic Wash Brush
WB90H	1	Replacement Brush Head

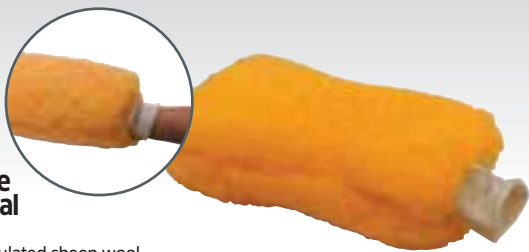

Extra Large Professional Wash Mitt

Made from simulated sheep wool.

- Trade quality.

Part No.	Qty	Description
WC15	1	Professional Wash Mitt



'Water Wizard' Waffle Drying Towel

Designed for professional use.

- Leaves a streak free finish.
- Dry a car in half the time!
- Double the absorption of standard towels.

Part No.	Qty	Size
WC12	1	560 x 760 mm



Jumbo Sponges

Synthetic sponge.

- Designed for professional use.

Part No.	Qty	Approx. Dimensions.
WC17	12	250 x 120 x 70 mm

Microfibre Drying Towel - Large Size

Long pile side for drying with short pile on the other side for detailing.

- Machine washable.
- Super soft edging will not scratch.
- Micro fibre technology attracts and holds on to dirt.

Part No.	Qty	Size
WC10	1	600 x 800 mm



Microfibre Cloths

Trade size.

- Heavy duty micro fibre.

Part No.	Pack of	Description
WC18	10	Micro Fibre Cloths



Large Ultra Fine Microfibre Glass Towel

Designed for professional use.

- Ultra fine silky shine finish.
- Perfect for cleaning glass.

Part No.	Qty	Size
WC11	1	400 x 480 mm



Microfibre Drying Towel - Extra Large

Designed for professional use.

High pile side for drying, short pile side for detailing.

- Absorbs 8 times its weight in water
- Super soft edging, will not scratch
- Low lint and clear coat safe

Part No.	Qty	Size
WC19	1	600 x 1000 mm



Polishing (Mutton) Cloths

100% cotton stockinette.

Part No.	Qty	Size
WC1	1	750g Roll
WC3	1	1 kg Bale of Cut Lengths
WC13	1	2 kg Bale of Precut Lengths



Professional Chamois Leather

Made from high quality New Zealand leather.

Part No.	Qty	Size
WC16	1	2.25 ft ²

Professional PVA Non-Perforated Synthetic Chamois

Mesh reinforced. Rot proof.

- Machine washable.
- More durable than a chamois leather.
- Soft and long lasting with high absorption.

Part No.	Qty	Size
WC14	1	660 x 430 mm



Looking for Polishing Pads & Discs?

Our full range can be found on Page 407



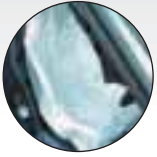

General Car Seat Protectors

Cover size: 800 x 640 mm.

Part No.	Qty	Weight
BAG35	Box of 100	15 Micron



Quality Car Seat Protectors

Roll width: 650 mm.

Part No.	Qty	Weight
BAG15	Roll of 100	25 Micron



Economy Car Seat Protectors

Supplied on a roll.

Part No.	Qty	Weight
BAG36	Roll of 100	10 Micron

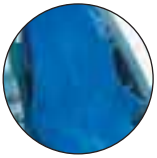

Nylon Seat Cover

Reusable.

Part No.	Qty	Description
BAG40	1	Nylon Seat Cover



Steering Wheel Covers

Part No.	Pack of	Description
BAG31	250	Steering Wheel Covers

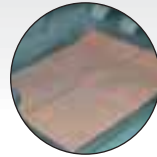

Paper Floor Mats

Dimensions: 510 x 360 mm.

Approx. Weight: 90g.

Part No.	Pack of	Description
BAG30	200	Paper Floor Mats



TENG TOOLS Magnetic Protective Wing Cover

Heavy duty red PVC front with TENG TOOLS logo, cloth backing and full length magnetic strip.

Part No.	Qty	Dimensions
TFC01	1	40 x 107 cm



5-in-1 Disposable Vehicle Interior Protection Set

Ideal for use by valeters and in garages to protect customer's vehicle interior whilst performing an M.O.T, service or general valet.

Part No.	Qty	Description
BAG51	100 Kits	5-in-1 Protection Kits

Kit includes: 1 x Disposable car seat cover, 1 x Disposable elasticated steering wheel cover, 1 x Disposable paper floor mat, 1 x Disposable gear stick cover, 1 x Disposable hand brake cover



S-A-S Leak Detector

For detecting leaks in pneumatic systems and compression lock fittings.

- Suitable for use with air con systems.
- Safe for use during engine operation.
- Meets the requirements of BS EN14291:2004 - LPG Safe.
- Non-flammable water based fluid.
- Suitable for Nitrogen gas NOT suitable for Oxysetaline.
- Suitable for MOT.

Part No.	Pack of	Size
SAS53	6	400ml Aerosols



AUTOSOL Metal Polish

Award winning metal polish, perfect for use on chrome, aluminium, stainless steel, brass and copper.

- Cleans, polishes and protects
- Leaves an invisible wax coating to ensure a long-lasting shine

Part No.	Qty	Size
VC131	12	100g Tubes
VC132	1	750ml Tin



S-A-S Assorted Pack - Cleaning Aerosols 500ml

A selection of popular cleaning aerosols, plus the No. 1 selling Universal Maintenance Lubricant which can be used for a wide range of everyday cleaning applications.

Part No.	Qty
SASC	Set of 6

6 x 500ml Aerosols: Brake Cleaner, Throttle Body Cleaner, Electrical Cleaner, Label & Gum Remover, Leak Detector, Universal Maintenance Lubricant.



RING UV Dye Range

Find leaks quickly and easily. Safe to leave in any system.



RING UV Dye for Automotive Oils & Fuels

Detect engine oils (mineral and synthetic), hydraulic oil, and petrol/diesel fluid leaks.

- 25ml Bottle suits: 10L Hydraulic Fluid, 3-4L Diesel Engine Oil, 8-10L Petrol Engine Oil and 15L Petrol/Diesel

Part No.	Qty	Dose Size
ERLD4	1	25ml Bottle

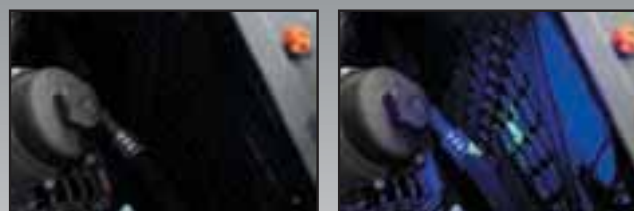

RING UV Dye for Coolant Systems

Add to coolant systems to detect leaks in water pipes and radiators.

- Safe to leave in any system

Part No.	Qty	Dose Size
ERLD2	1	25ml Bottle



RING UV Dye for Air Con/Refrigerant Systems

Inject into the A/C system and detect any refrigerant leaks from the system*.

(*Engineers conducting A/C tests MUST be F-Gas registered).

- 5ml Bottle suits: 250ml of Refrigerant

Part No.	Qty	Dose Size
ERLD1	1	5ml Bottle



SAS



S-A-S Brake Cleaner

Cleans brake and clutch parts without dismantling.

- Removes brake fluid, oil, dust, etc.
- Helps maximise brake efficiency.
- Prevents objectionable dust escaping into working environment.
- Acetone FREE Formula - Safe to use in most Solvent Sprayers.

Part No.	QTY	Description
SAS81A	1	1 Litre Bottle
SAS81	12	1 Litre Bottles
SAS52	4	5 Litre Containers *
SAS2000T	1	5 Litre Dispenser Tap
SAS62	1	25 Litre Drum - Side Tap Facility *
SAS62T	1	Drum Tap Suits Part No. SAS62

* Limited availability due to transport regulations

SAS



S-A-S Brake Cleaner

Cleans brake and clutch parts without dismantling.

- Removes brake fluid, oil, dust, etc.
- Helps maximise brake efficiency.
- Prevents objectionable dust escaping into working environment.

Part No.	Pack of	Size
SAS72	12	200ml Aerosols
SAS2	6	500ml Aerosols



Solvent Pressure Sprayers

Polyamid pump with FKM seals. Polyethylene container.

Part No.	Qty	Capacity
CAN12	1	1 Litre
CAN15	1	1.5 Litre



Syphon Pumps

Flexible hose. 2" BSP.

- Suitable for dispensing light oils and non-aggressive chemicals.

Part No.	Qty	Suitable for
CAN25	1	25 Litre Drums
CAN60	1	60 - 205 Litre Drums

Lever Operated Barrel Pump

Supplied with a 2" BSP and Tri-sure adaptor. Includes telescopic riser tube and 2 metre hose. Polypropylene body. Viton seals. 500cc flow rate (per stroke). Size: 1 m x 260 mm. NOT suitable for products containing Toluene.

- Suitable for use with:
- AdBlue® Solution
 - Water based liquids
 - Solvents
 - Screenwash
 - Thinners
 - Antifreeze
 - Light oils

Part No.	Qty	Suitable for
CAN50	1	50 - 205 Litre Drums

SAS

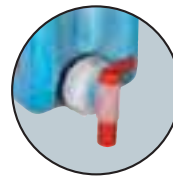

S-A-S Citrus Fragrance All Purpose Cleaner

Supplied in a stackable UN container. Soiling dilution ratio: Very heavy use neat, Heavy 10:1, Medium 50:1, Light 100:1.

- Non Harmful Formulation - Safe to use on virtually any substrate, cleans all hard surfaces including floors, walls, desks & washrooms
- Alloy Wheel Safe Formula - Perfect for cleaning vehicles inside and out, including highly polished and anodized aluminium alloy wheels
- Alcohol FREE formula

Part No.	Qty	Size
SAS2010	1	5 Litre Container
SAS2000T	1	5 Litre Dispenser Tap



Funnels + Sprayers

Our complete range of liquid handling products starts on Page 358



SAS

S-A-S Electrical/Contact Cleaner

Removes oil, tar, grease and helps remove carbon residues.

- Improves conductivity and helps prevent arcing and electrical breakdown.
- For all heavy duty electrical components, e.g. Switch gear, motors, relays.

Part No.	Pack of	Size
SAS10	6	500ml Aerosols

BEST SELLER



Ambersil

AMBERSIL 'Amberklene FE10' Fast Drying Solvent

A powerful, fast evaporating solvent cleaner and de-greaser. Ideal for removing grease from bearing housings and gear teeth. Removes copper paste from threaded fasteners. Can also be used for stain removal.

- Silicone FREE.
- Powerful flushing action, rapidly removes contaminants.
- Safe for use on ferrous and non-ferrous metals and most plastics.
- Meets military specification NATO catalogue No. 6850-99-6636478.

Part No.	Qty	Size
AMB100	1	400ml Aerosol



BEST SELLER



SAS

S-A-S Label Remover

- Removes Sticker Glue, Masking Tape, Clear Adhesive Tape and Tar.

Part No.	Pack of	Size
SAS58	6	500ml Aerosols



SAS

S-A-S Leak Detector

For detecting leaks in pneumatic systems and compression lock fittings.

- Suitable for use with air con systems.
- Safe for use during engine operation.
- Meets the requirements of BS EN14291:2004 - LPG Safe.
- Non-flammable water based fluid.
- Suitable for Nitrogen gas NOT suitable for Oxysetaline.
- Suitable for MOT.

Part No.	Pack of	Size
SAS53	6	400ml Aerosols



SAS

S-A-S Paint & Gasket Remover

- Removes work gaskets from rocker box covers, water pumps, manifolds etc.
- Removes paints, varnishes and lacquers, prior to refinishing.
- Removes rubber residues from wheel hubs prior to fitting new or repaired tyres.
- Removes charred oil residues from engine components.

Part No.	Pack of	Size
SAS5	6	500ml Aerosols



SAS

S-A-S Tar & Gum Remover

Supplied in a stackable UN container.

- Extremely Strong Formula - Instantly dissolves tar & gum on paintwork & plastics
- Multi-Purpose Application - Can also be used to remove oil, grease, fuel stains, wax, silicone & adhesive residue

Part No.	Qty	Size
SAS2058	1	5 Litre Container



SAS

S-A-S Throttle Body Cleaner

For all types of carburettors and fuel injection systems. No effect on catalytic converters or lambda sensors.

- Removes tars and gum build up.
- Improves performance and economy.

Part No.	Pack of	Size
SAS4	6	500ml Aerosols

BEST SELLER



SAS

S-A-S Heavy Duty Surface Degreaser

Suitable for use in power wash and hand pump wash dispensers. Can also be used for hand application.

- Suitable for use on engines and chassis.
- Water-based and non-flammable - Suitable for petrol station forecourts.
- Economical formula - can be diluted
- Silicone FREE formula.

Part No.	Qty	Size
SAS1059	1	5 Litre Container



BEST SELLER



**Grease Nipples
Straight - Imperial**

Part No.	Pack of	Size	Type
GN1	50	1/8" BSP Gas	H1
GN3	50	1/4" UNF	H1
GN5	25	1/4" BSP	H1

BEST SELLER



**Grease Nipples
Straight - Metric**

Part No.	Pack of	Size x Pitch	Type
GN7	25	M6 x 1.00 mm	H1
GN9	25	M8 x 1.00 mm	H1
GN11	25	M8 x 1.25 mm	H1
GN13	25	M10 x 1.00 mm	H1



**Grease Nipples
Angled 45° - Imperial**

Part No.	Pack of	Size	Type
GN2	50	1/8" BSP Gas	H2
GN4	50	1/4" UNF	H2
GN6	25	1/4" BSP	H2



**Grease Nipples
Angled 45° - Metric**

Part No.	Pack of	Size x Pitch	Type
GN8	25	M6 x 1.00 mm	H2
GN10	25	M8 x 1.00 mm	H2
GN12	25	M8 x 1.25 mm	H2
GN14	25	M10 x 1.00 mm	H2



**Grease Nipples
Angled 90° - Imperial**

Part No.	Pack of	Size	Type
GN35	25	1/8" BSP Gas	H3
GN36	25	1/4" UNF	H3
GN37	25	1/4" BSP	H3



**Grease Nipples
Angled 90° - Metric**

Part No.	Pack of	Size x Pitch	Type
GN31	25	M6 x 1.00 mm	H3
GN32	25	M8 x 1.00 mm	H3
GN33	25	M8 x 1.25 mm	H3
GN34	25	M10 x 1.00 mm	H3



**Grease Nipples
Straight long.**

Part No.	Pack of	Size	Type
GN15	25	1/4" UNF	H1



**Grease Nipples
- Button Head (Tat Type)**

Straight. 15 mm Hex.

Part No.	Pack of	Size	Type
GN16	25	1/8" BSP Gas	T1B



**Slide-on
Connectors**

1/8" BSP Gas.
Suits GN16 (for Button Head Nipple).

Part No.	Pack of	Description
GN17	2	Slide-on Connectors



UMETA

**UMETA
4-Jaw Hydraulic
Connectors
- Standard Type**

1/8" BSP Gas.

Part No.	Pack of	Description
GN19	5	Standard Type



**4-Jaw Hydraulic
Connectors
- General Purpose**

1/8" BSP Gas.

Part No.	Pack of	Type
GN191	10	General Purpose

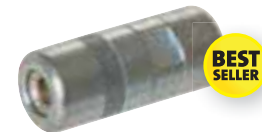

**4-Jaw Hydraulic
Connectors
- Heavy Duty**

1/8" BSP Gas.

Part No.	Pack of	Type
GN192	3	Heavy Duty



Flexible Rubber Hose - Snap-on Flexible Extension

1/8" BSP Gas. Complete with 4-jaw hydraulic connector.

Part No.	Qty	Length
GN22	1	300 mm (12")



BEST SELLER

Flexible Rubber Hose

1/8" BSP Gas.

Part No.	Qty	Length
GN20	1	300 mm (12")
GN23	1	450 mm (18")

PRESSOL



BEST SELLER

PRESSOL Grease Gun

Metal bodied, cast head. Complete with extension pipe and 4-jaw hydraulic connector. 1/8" BSP. Takes 400g cartridge.

- 1.2 cc/stroke.
- Withstands pressure up to 7,000 PSI.

Part No.	Qty	Description
TL895	1	Grease Gun

UMETA



BEST SELLER

UMETA Grease Gun

Metal bodied, cast head. Complete with extension pipe and 4-jaw hydraulic connector. 1/8" BSP. Takes 400g cartridge.

- 2.0 cc/stroke.
- Withstands pressure up to 10,000 PSI.

Part No.	Qty	Description
TL922	1	Grease Gun



BEST SELLER

Grease Gun

Metal bodied. Complete with extension pipe and 4-jaw hydraulic connector. 1/8" BSP. Takes 400g cartridge.

- 1.3 cc/stroke.
- Withstands pressure up to 8,000 PSI.

Part No.	Qty	Description
TL899	1	Grease Gun



Oil Suction Guns

Supplied with 400 mm hose.

Part No.	Qty	Capacity
CAN16	1	500 cc
CAN11	1	800 cc
CAN18	1	1000 cc



Air Operated Grease Gun

Complete with extension pipe and 4-jaw hydraulic connector. Takes 400g cartridge or bulk feed.

Part No.	Qty	Description
TL920	1	Grease Gun



Grease Pump Unit

For 12.5 kg keg. Complete with follower plate. 1.5 m hose.

Part No.	Qty	Description
GN52	1	Grease Pump Unit



Lever Action Hand Pump

Adjustable to suit up to 250 litres (55 gallon) drums. 2" BSP female outlet for oil and other non-corrosive fluids. Output in excess of 250 cc/stroke. (NOT suitable for Anti-freeze).

Part No.	Qty	Description
GN51	1	Hand Pump





FUCHS RENOLIT EP2 Multi-Purpose EP Lithium Grease

Part No.	Qty	Size	Colour
VC181A	3	400g Cartridges	Brown
VC181	12	400g Cartridges	Brown
VC171	6	500g Tubs	Brown
VC182	1	5 kg Tub	Brown



FUCHS RENOLIT LX-EP2 Lithium Complex Grease

Longer life at high temperature.
Temperature range: -30°C to +160°C.

Part No.	Box of	Size	Colour
VC180	12	400g Cartridges	Natural



FUCHS RENOLIT Copper Paste

High temperature anti-seize lubricant.
Temperature range -30°C to 1100°C.

Part No.	Qty	Size
VC187	1	500g Tub



FUCHS RENOLIT G51 Red Rubber Grease

Suitable for natural and synthetic rubbers. A special rubber compatible grease for use on hydraulic brake and clutch components where hardening or swelling of rubber must be avoided. Designed to assist in the assembly of rubber components of brake, clutch and suspension units.

Part No.	Qty	Size
VC188	1	500g Tub



FUCHS RENOLIT MP3 Lithium Grease

Multipurpose with anti-wear and anti corrosion properties.
Temperature range: -30°C to +125°C.

Part No.	Qty	Size
VC179	12	400g Cartridges



FUCHS RENOLIT MO2 Lithium Grease (CV Joint Grease)

Molybdenum Disulphide EP Grease with Graphite.
Temperature range: -25°C to 120°C.

Part No.	Box of	Size
VC184	12	400g Cartridges



ARCTIC HAYES Silicone Grease

WRAS approved. Clear paste.
Operating temperature: -50°C to 200°C.

- Resistant to water, ultraviolet rays and oxygen.
- WRAS approved food safe and virtually non-toxic.
- Resilient and flexible even after completing the curing process.
- Resistant to interaction with other chemicals.
- An excellent electrical insulator.

Part No.	Qty	Size
VC189	1	500g Tub



S-A-S Moly Anti-Scuff Paste

Contains 40% micronized Molybdenum Disulphide plus graphite forming soft paste. Load carrying capacity of MoS₂ is in excess of 140,000 PSI.

- Operating temperature: -20°C to +1000°C
- Ideal for pre-treatment of plain bearings, gears, piston rings, cams and valve stems which cannot be lubricated with normal grease after assembly. Threaded components in refrigerating and air consystems.

Part No.	Qty	Size
SAS194	1	500g Tin

SAS



S-A-S EP2 Lithium Grease

High quality lithium grease.

- Temperature range: -20°C to +140°C
- Excellent extreme pressure and anti-wear performance
- High degree of corrosion protection
- Highly versatile multi-purpose grease
- 4-Ball weld load rating: 315 kg

Part No.	Qty	Size	Colour
SAS171	1	500g Tub	Dark Brown
SAS181	12	400g Cartridges	Dark Brown

SAS



S-A-S EP2 Lithium Complex Grease

Specially developed lithium complex grease.

- Temperature range: -20°C to +150°C
- Exceptional mechanical stability extends relubrication interval
- Long lasting lubrication at high temperatures
- Excellent EP and anti-wear performance
- Good corrosion resistance components operating in wet conditions
- 4-Ball weld load rating: 450 kg

Part No.	Box of	Size	Colour
SAS180	12	400g Cartridges	Dark Brown

SAS



S-A-S Brake Grease

Copper FREE Bentone anti-seize compound.

Unique locking/dispenser cap for precision application.

- ABS Compatible
- Reduces squeaking
- Water resistant
- Wide temperature range
- Protects against scratching and corrosion

Part No.	Box of	Size
SAS192A	1	75ml Tube
SAS192	10	75ml Tubes

SAS



S-A-S Ceramic Anti-Seize Compound

Smooth beige paste. Very high purity, metal-free, anti-seize compound and assembly paste.

- Any sub-zero temp to +1500°C
- Prevents electrolytic corrosion as the product insulates differing metals from each other
- Ideal for use on anti-lock braking systems, ASR traction control, all studs, nuts, bolts and other threaded connections. Heating systems (boilers, furnaces, turbines, burner nozzles, etc.).

Part No.	Qty	Size
SAS193	1	500g Tub

SAS



S-A-S Copper Grease

Anti-seize compound.

- High temperature range: -40°C to +1100°C
- Protects against rust, oxidation and other corrosion

Part No.	Qty	Size
SAS107A	1	500g Tin
SAS107	6	500g Tins
SAS173	1	3 kg Tin

SAS



S-A-S Copper Grease

Stable up to 275°C as a grease & up to 1200°C as a release agent.

- For high temperature applications: Brake and hand brake linkages, exhaust manifold nuts, studs & parts, wheel nuts
- Can be used on boilers and water heaters, e.g. Inspection flanges and to lubricate moving parts in heat treatment industry

Part No.	Pack of	Size
SAS17	6	500ml Aerosols

SAS



S-A-S Red Rubber Grease

A top quality lubricating grease.

- Temperature range: -40°C to 110°C
- Ideal for use on brake assemblies

Part No.	Qty	Size
SAS188A	1	500g Tin
SAS188	6	500g Tins

SAS



S-A-S Aluminium Anti-Seize Compound

Copper FREE anti-seize compound.

- High temperature range: Any sub-zero temp to +1100°C
- Use on all studs, nuts, bolts and other threaded connections
- Invaluable for application to any component that needs to be dismantled

Part No.	Qty	Size
SAS190A	1	500g Tin
SAS190	6	500g Tins





FUCHS 'Renolin' ZAF 46 HV High Quality Hydraulic & Lubricating Oil

High viscosity index, zinc and ash free hydraulic oil.

- Ideal for powering hydraulic systems working in refrigerated plant, mobile equipment, or where the system demands a fluid capable of working over a wide temperature range.



Part No.	Qty	Size
VC117	1	20 Litres



FUCHS 'Agrifarm' Universal 2-stroke Oil

Specifications: API, TC, JASO, FB. Suitable for use in all 2-stroke engines. May be used either as a tank mix or in oil injection systems. Dyed red for ease of identification.

- Ideal for agricultural and horticultural machinery, chain saws, hedge cutters, trimmers, portable generators, etc.



Part No.	Qty	Size
VC116	1	20 Litres



FUCHS 'Titan Truck Plus' 15W-40 Oil

Specifications: ACEA E7, API CI-4/SL, GLOBAL DHD-1, CAT ECF-1-a/ECF-2. A super long term all season engine oil of the SHPD category for diesel and gasoline engines with and without turbo charging in passenger cars, trucks, buses and industrial equipment

- Excellent wear protection even under high continuous stress
- Protection from corrosion even when used with diesel fuels with high sulphur content

Part No.	Qty	Size
VC115A	1	5 Litres
VC115	1	20 Litres



ROCK OIL ISO-32 Hydraulic Oil

Meets DIN 51525 and DIN 51524 Parts 1 & 2.

- Excellent protection of machinery and systems against corrosion and wear.
- * NOT to be used as Brake Fluid.

Part No.	Qty	Size
VC199	1	20 Litres

CreteBeater®



CreteBeater 'Civil Engineering' Heavy Duty Concrete Remover

100% biodegradable and designed to safely remove cement and concrete by dissolving it in a bio-safe way. Does not contain muriatic, phosphoric or citric acids and is therefore, non-corrosive.

Safe to use on:

- Painted surfaces/vehicles
- Glass/Windows
- Human Handling
- Aluminium
- Rubber/Tyres/Hoses

Part No.	Qty	Pack Size
CB20	1	20 Litre Container



ALTA Foam Pressure Sprayer

Contains FPM VITON® (FKM) seals. Supplied with lance to adjust the foam thickness. Suitable for use with SAS2017.

- High foaming action spray
- Lance with 120 cm long hose

Part No.	Qty	Working Capacity
CAN28	1	6.0 Litre





MAINTAINING AUTOMOTIVE & ENGINEERING PROFESSIONALS FOR OVER 35 YEARS

S-A-S has been the Universal Maintenance Lubricant of choice for automotive and engineering professionals for over 35 years. The formula that you've come to trust continues to deliver outstanding performance across countless applications in all industrial environments.



BEST SELLER



The 500 ml aerosol contains a 360° valve which means it can be sprayed at any angle, even upside down, making it the ideal maintenance lubricant for a vast range of projects.



BEST SELLER

S-A-S Universal Maintenance Lubricant

Bulk liquid for use with dispensers

- Penetrates & lubricates.
- Cleans & degreases.
- Protects all metals.
- Contains PTFE.
- Frees seized parts fast!
- Inhibits rust & corrosion.
- Displaces moisture.
- Silicone FREE formula.

Part No.	Qty	Size
SAS22A	1	5 Litre Container
SAS22	4	5 Litre Container
SAS23	4	500ml Trigger Sprayers



WD-40 Multi-Purpose Lubricant

WD-40 protects metal from rust and corrosion, penetrates stuck or jammed parts, displaces moisture, and lubricates just about anything. WD-40 is also great when it comes to cleaning grease, grime, and other marks from most surfaces.

Part No.	Pack of	Size
VC140	12	450ml Aerosols



BEST SELLER

S-A-S Universal Maintenance Lubricant

Advanced formula with rust inhibitors and moisture displacers.

- Penetrates & lubricates.
- Cleans & degreases.
- Protects all metals.
- Contains PTFE.
- Frees seized parts fast!
- Inhibits rust & corrosion.
- Displaces moisture.
- Silicone FREE formula.

Part No.	Pack of	Size
SAS6	12	200ml Aerosols
SAS20	12	500ml Aerosols with 360° Valve



S-A-S Extreme Universal Maintenance Lubricant

Meets the requirements of MoD specification 68-10 [PX-24] and NATO C-634 for water-displacing corrosion preventatives.

- Improved corrosion protection vs standard multi-purpose lubricants
- High concentration of water displacement additives mean it can be applied directly to wet surfaces
- Virtually colourless & transparent
- Excellent lubrication properties

Part No.	Qty	Size
SAS21A	1	500ml Aerosol



NEW



SAS

S-A-S Extreme Universal Maintenance Lubricant

Meets the requirements of MoD specification 68-10 [PX-24] and NATO C-634 for water-displacing corrosion preventatives.

- Improved corrosion protection vs standard multi-purpose lubricants
- High concentration of water displacement additives mean it can be applied directly to wet surfaces
- Virtually colourless & transparent
- Excellent lubrication properties

Part No.	Qty	Size
SAS21A	1	500ml Aerosol



Ambersil

AMBERSIL 'PX24' Industrial Strength Protective Lubricant

Formulated specifically to meet exacting standards of Military maintenance personnel. A multi-purpose lubricant, corrosion inhibitor, dewatering & protective fluid. No adverse effects on rubber, paintwork or plastics and acrylic sheet polyester, glass fibre laminate, vinyl sheet and ebonite after immersion for 240 hours.

- Meets with NATO military specifications.
- Water Displacement: Complete Displacement of NaCl test solution (IP 178).
- Corrosion Protection: Pass/No Corrosion (IP 178).
- Temperature range: -20°C to +115°C.

Part No.	Qty	Size
AMB110	1	400ml Aerosol



WD-40

WD-40 Multi-Purpose Lubricant

WD-40 protects metal from rust and corrosion, penetrates stuck or jammed parts, displaces moisture, and lubricates just about anything. WD-40 is also great when it comes to cleaning grease, grime, and other marks from most surfaces.

Part No.	Pack of	Size
VC140	12	450ml Aerosols



SAS

S-A-S Freeze Release Spray

Shock freeze and release of seized and corroded parts.

- Quick release of seized parts.
- Prevents corrosion.
- 2-in-1 Maintenance lubricant spray.

Part No.	Qty	Size
SAS147	6	500ml Aerosols



Swarfega



SWARFEGA 'Duck Oil'

A silicone-free, non-conductive, multi-purpose service spray. Exceptionally low surface tension means it can easily penetrate and protect with no need to dismantle machinery and parts.

Part No.	Qty	Size
DEB20	1	5 Litre Tin

Ambersil

AMBERSIL 'Dry Moly' Dry Molybdenum Disulphide Lubricant

A resin bonded, high pressure resistant, dry film lubricant containing Molybdenum Disulphide (MoS₂) for metal-to-metal lubrication where a wet film cannot be tolerated. Once applied, the MoS₂ lubricant prevents seizing, fretting, scuffing & reduces friction.

- Tough and long lasting
- Repels water
- Will not attract dust, dirt and contaminants
- Assists assembly and running-in
- Highly effective in high-load applications
- Performance can be enhanced by polishing the dry film with a soft, dry cloth
- Operational temperature range: -150°C to +400°C

Part No.	Qty	Size
AMB111	1	400ml Aerosol



Swarfega



SWARFEGA 'Duck Oil' Trigger Sprayer

For use with Part No. DEB20. Supplied empty.

Part No.	Qty	Description
DEB21	1	500ml Trigger Sprayer (supplied empty)

BRADEX Easy Start

Starts all engines. Suitable for diesel, petrol and paraffin engines.

Part No.	Pack of	Size
VC145	12	280ml Aerosols



SAS

S-A-S Graphited Penetration Oil

Rapidly and efficiently loosens and frees seized nuts, bolts and hinges.

- Spray gives a grey low viscosity highly penetrating liquid.
- Incorporates a residual lubricant to help reduce friction during dismantling.
- Leaves a film to protect against further corrosion.
- Silicone FREE.

Part No.	Pack of	Size
----------	---------	------

SAS1	6	500ml Aerosols
------	---	----------------



SAS

S-A-S Food Safe Lube

For food preparation and food packing machinery. For use on chain sprockets, slides or any moving part. Water resistant, suitable for wet pack operations.

- Based on edible Soya bean oil.
- Nut and nut oil FREE.
- Taint FREE formula.
- Temperature range: -10 to 100°C.

Part No.	Pack of	Size
----------	---------	------

SAS12	6	500ml Aerosols
-------	---	----------------



SAS

S-A-S Clear Fine Oil

For use in difficult places where lubrication is normally carried out with conventional oil can.

- Gives economical application on types of machinery, small lightly loaded bearings, etc.

Part No.	Pack of	Size
----------	---------	------

SAS56	6	500ml Aerosols
-------	---	----------------

BEST SELLER



SAS

S-A-S Chain and Cable Lube

For heavyweight drive chains, e.g. Fork-lift truck masts, motor cycle chains.

- Silicone FREE
- Penetrating, anti-filing formula.
- Rubber grommet friendly.

Part No.	Pack of	Size
----------	---------	------

SAS14	6	500ml Aerosols
-------	---	----------------

BEST SELLER



SAS

S-A-S White Grease

Universal grease with almost limitless applications, e.g. Locks, hinges and striker plates. Suitable for clean area applications.

- Anti water wash-out properties
- Provides visual check where used
- Anti-corrosive
- Silicone FREE

Part No.	Pack of	Size
----------	---------	------

SAS7	6	500ml Aerosols
------	---	----------------

BEST SELLER



SAS

S-A-S Heavy Duty Open Gear Lube

Designed specifically for exposed gears, wire ropes, heavy duty chains and other moving parts.

- Ideal for exterior use - provides extra protection against rust, corrosion and wear vs standard chain and cable lube
- Maximises the service life of wire rope
- Excellent resistance to salt water environment
- Contains bitumen for improved durability & corrosion protection
- Rapid penetration into wire ropes, gears and link
- Excellent de-watering properties
- Viscosity modifiers prevent throw off ensuring long working life
- Low tack when dry helps reduce dirt build-up

Part No.	Qty	Size
----------	-----	------

SAS33A	1	500ml Aerosol
--------	---	---------------

NEW



SAS

S-A-S Clear Grease

For use on areas requiring a tenacious lubricant, whilst retaining a good cosmetic appearance, e.g. Car door locks.

- Silicone FREE
- Does NOT contain PTFE

Part No.	Pack of	Size
----------	---------	------

SAS18	6	500ml Aerosols
-------	---	----------------

BEST SELLER



SAS

S-A-S Cutting Oil

For all metal types.

- Improves lubrication/cooling.
- Retains viscosity at high cutting temperatures.
- Prevents tarnishing.
- Extends tool life.

Part No.	Pack of	Size
----------	---------	------

SAS46	6	500ml Aerosols
-------	---	----------------

BEST SELLER



SAS

S-A-S Silicone Spray

For use on curtain slider tracks, folding bus and train doors, coin operated machines, etc. Use as a mould release and for easing slip-fitting parts assembly. Use on surfaces where heat is present, e.g. heat sealing machines. Imparts waterproofing qualities to fabrics, e.g. tarpaulins, industrial outdoor clothing.

- Stable to 275°C
- Lowers friction & prevents sticking
- Low stain formula
- Zero effect on plastics
- Contains Silicone
- NOT food safe

Part No.	Pack of	Size
SAS8	6	500ml Aerosols



SAS

S-A-S Weld Anti-Spatter

Water Based

- Provides a protective oily film for use in welding
- Silicone FREE

Part No.	Pack of	Size
SAS9	6	400ml Aerosols



SAS

S-A-S Silicone Grease

- Moisture repelling
- Excellent insulating properties for electronic control and switchgear in exterior applications
- Contains Silicone

Part No.	Pack of	Size
SAS19	6	500ml Aerosols



SAS

S-A-S Rubber Care

Maintains rubber seals on doors, bonnets, tailgates, etc. Can be used on tyres, rubber mats and rubber trim strips.

- Reduces the effect of spray and salt water
- Reduces the effects of diluted acids and alkalines
- Prevents rubber parts ageing and cracking and eliminates squealing noises from dry rubber
- Silicone FREE

Part No.	Pack of	Size
SAS57	6	500ml Aerosols



SAS

S-A-S Battery Terminal Protector

Suitable for use on batteries and earthing straps in cars, buses, trains and plant hire equipment.

- Protects against corrosion
- Improves electrical continuity thus improving starting
- Contains an indicator to visualise acid leaks (turns red)
- Waterproofs terminals

Part No.	Pack of	Size
SAS3	6	500ml Aerosols



SAS



S-A-S Assorted Pack - Lubricant Aerosols 500ml

A selection of our fastest moving lubricant aerosols, including the No. 1 selling Universal Maintenance Lubricant used for a multitude of lubricating and maintenance applications.

Part No.	Qty
SASL	Set of 6

6 x 500ml Aerosols: White Grease with PTFE, Clear Grease, Silicone Spray, Chain & Cable Lube, Copper Grease, Universal Maintenance Lubricant.



Looking for Wire Brushes?

Our complete range wire brushes are available from Page 400



LOCTITE '7503' Rust Remedy

Supplied on a blister card.

Part No.	Qty	Size
VC955	1	90ml Bottle



GRANVILLE Rust Cure Convertor

A co-polymer latex combined with organic chelating agents designed for application to corroded ferrous substrates. It actively converts the rust present on the substrate into a stable organic iron complex. As the polymer dries it forms an impermeable barrier to oxygen and moisture effectively sealing out any further corrosion. Contact with aliphatic or aromatic solvents will cause softening of the film which will recover.

- Water based formulation
- Extremely low order of toxicity
- Does not contain phosphoric acid or lead
- Excellent resistance to acid and alkali splashes

Part No.	Qty	Size
VC161	1	1L Bottle



GRANVILLE Rust Repair Gel

A highly effective non drip rust neutraliser and inhibitor based on organic and inorganic acids. It is suitable for treating all ferrous surfaces and will quickly remove and neutralise rust.

- Non drip formulation - Ideal for horizontal and hard to reach areas
- Easy to apply
- Effectively treats rust
- Over paintable
- Fast acting gel formulation

Part No.	Qty	Size
VC162	1	150g Bottle



GRANVILLE Rust Repair Liquid

A highly effective rust neutraliser and inhibitor based on organic and inorganic acids. It is suitable for treating all ferrous surfaces and will quickly remove and neutralise rust.

- Easy to apply
- Effectively treats rust
- Over paintable
- Fast acting liquid formulation

Part No.	Qty	Size
VC163	1	500ml Bottle



BEST SELLER



JENOLITE 'The Original' Rust Remover - Liquid

A free-flowing liquid rust removal product that can be applied by spray, brush or immersion. Ideal for box sections, tubular components and articles with tight recessed areas.

- Easy to apply - No need to rinse off, simply wipe the surface after application
- Rust will disappear to leave a stable surface ready for priming and painting

Part No.	Qty	Size
VC235	1	500ml Bottle



JENOLITE 'The Original' Rust Remover - Gel

A concentrated non-drip gel handy for treating small areas of rust or corrosion on cars, bikes, household appliances and gardening equipment. You can also use it to clean rust spots off chrome plating prior to lacquering or polishing.

- Easy to apply - No need to rinse off, simply wipe the surface after application
- Rust will disappear to leave a stable surface ready for priming and painting
- Ideal for small rust spots

Part No.	Qty	Size
VC234	1	40g Tube



JENOLITE 'No Prime' Rust Convertor - Liquid

The complete remedy for rust! It removes rust, provides a seal to prevent its return, and allows the surface to be painted over without the need for primer.

- 2-in-1 Application - Gets rid of the rust and converts the once rusted area into a stable, polymer coated surface ready to paint.
- Provides proven resistance to chemical, bacterial and salt spray attack, as well as a barrier to water vapour, oxygen and carbon dioxide
- Removes even the most stubborn rust to leave metal looking as good as new!

Part No.	Qty	Size
VC237	1	250g Tub



NEW



S-A-S Ultimate Rust Protector

High melt point of 100-120°C makes it ideal for elevated temperature applications / environments.

- Ideal for protecting metallic surfaces and inner panels from corrosion e.g. underbody, sills, cracks etc.
- Stops rust and helps prevent future corrosion forming
- Self healing - minor damage to the coating will reflow over time
- Excellent salt spray and humidity resistance
- Unlike resin / paint products it will not peel or chip

Part No.	Qty	Size
SAS63A	1	500ml Aerosol



SAS**S-A-S Bright Alu Zinc Galv Spray**

Zinc & Aluminium based coating.

- 60% metal content in the dried paint film
- Ideal for the bright cosmetic finish and protection of previously galvanised surfaces
- Excellent corrosion resistance
- Self priming - one step process
- Ideal for spot repairs after welding
- Weld-through
- Excellent adhesion to metallic surfaces

Part No.	Qty	Size
SAS68A	1	500ml Aerosol

NEW**Ambersil****AMBERSIL 'Cold Galvanise' Zinc-Rich Protective Coating**

A zinc rich acrylic coating that offers excellent Cathodic anti-corrosion protection to steel fabrications and all exposed ferrous metalwork. Suitable as a primer, can be over coated with acrylic, cellulose, alkyd, polyurethane-alkyd & epoxy paints.

- Protects metalwork & steels from corrosion.
- Can be welded through.
- For use on bare non-rusted steel & seams.
- Zinc 99% pure, content 88% cured film.
- Suitable for use as renovation media as specified in BS EN ISO 1461:1999.
- Matt, dark grey, weathered appearance.
- Fast drying & Xylene free.

Part No.	Qty	Size
AMB120	1	400ml Aerosol

**SAS****S-A-S Zinc Spray**

Use as a primer coat which can be over painted with acrylic, cellulose, alkyd, polyurethane alkyd and epoxy. Use as a coating on pipes and steel fabrications.

- 66% zinc content (in dry film).
- Thin film (e.g. Single coat) can be welded through.

Part No.	Pack of	Size
SAS24	6	500ml Aerosols

BEST SELLER**Ambersil****AMBERSIL 'Alu Hi Temp' High Temperature Corrosion Protection**

Corrosion protection for high temperature applications based on aluminium pigments. Builds a glossy, hard film on metal surfaces after exposure to high temperatures (+1 hour at 200°C) and is not eroded over time. For use on ferrous metals subjected to continuous high temperatures.

- Dry to touch in 15 minutes.
- Lead and Chromate free.
- Continuous protection up to 600°C.
- Passes ASTM D-2485 1-68: Methods 2 & 3.

Part No.	Qty	Size
AMB121	1	400ml Aerosol

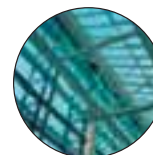
**SAS****S-A-S Primer Adhesion Promoter**

Clear primer for difficult plastic substrates.

- Excellent adhesion to PP / PP composites, TPO (Thermoplastic Olefin), rigid vinyl and SMC (glass fibre reinforced polyester) and fibreglass
- Also improves paint adhesion to galvanised steel, non-ferrous metals (aluminium) and wood
- Reduces the need to pre-abrade surfaces before painting
- No sanding required post application
- Very low film build, virtually invisible
- Quick drying

Part No.	Qty	Size
SAS65A	1	500ml Aerosol

NEW**VIP****VIP 'Perfect-Fill' High Build Primer**

Suitable for plastics and metal.

- For deep filling and fast priming of surface defects.

Part No.	Qty	Colour	Size
VIP45G	1	Grey	400ml Aerosol
VIP45DG	1	Dark Grey	400ml Aerosol
VIP45W	1	White	400ml Aerosol



SAS

S-A-S Anti Corrosion Graphene Primer

Exceptional corrosion protection 1750+ hours ASTM G-85. Smooth matt grey finish with excellent sanding properties.

- Zinc Free formula - Less environmentally hazardous
- Excellent barrier properties of Graphene extends coating life
- Fast drying - Touch dry in 3-4 mins, sand & top-coat in 20 mins
- Excellent adhesion to metallic surfaces - Mild Steel & aluminium
- Excellent Flexibility - ASTM D522 Conical Mandrel - No cracking
- Excellent anti-sag properties enables high coat depths
- Fills minor surface imperfections
- Can also be applied to many rigid plastics

Part No.	Qty	Size
SAS66A	1	500ml Aerosol



SAS

S-A-S Primer - Grey

Acrylic
• Fast drying.

Part No.	Pack of	Size
SAS35	6	500ml Aerosols



SAS

S-A-S 1K Epoxy Primer

Single component epoxy modified primer for improved durability, toughness and corrosion protection. Matt red oxide finish.

- Contains Zinc Phosphate to further improve anti-corrosive performance
- 1000+ hours salt spray performance (ASTM B-117)
- Excellent adhesion to metallic surfaces - Mild steel & aluminium
- Ideal for exterior applications or harsher environments / area prone to corrosion e.g. car chassis
- No need to top-coat other than for cosmetic finish
- High solids - Free from metals

Part No.	Qty	Size
SAS67A	1	500ml Aerosol



SAS

S-A-S Primer - Red Oxide

Acrylic
• Fast drying.

Part No.	Pack of	Size
SAS37	6	500ml Aerosols



SAS

S-A-S High Build Etch Primer

High build primer and acid etch in a single product.

- Twice the paint solids of many conventional primers
- Improved adhesion to problematic metallic surfaces e.g. non-ferrous metals (aluminium and its alloys, brass, copper) and zinc coated steel (Zintec)
- Excellent anti-sag properties enable high coat depths to be achieved
- Fills minor surface imperfections
- Smooth matt finish with excellent sanding properties
- Can also be applied to many rigid plastics.

Part No.	Qty	Size
SAS64A	1	500ml Aerosol



SAS

S-A-S Primer - White

Acrylic
• Fast drying.

Part No.	Pack of	Size
SAS36	6	500ml Aerosols



Looking for Paints?

Our complete range is available on the next page

SAS**BEST SELLER****S-A-S Black Paint - Matt**

Tough acrylic formula paint for interior and exterior use.

- Suitable for use on wood, metal, glass, ceramic, paper, card and most plastics
- Professional fan spray - Adjustable nozzle for different spray patterns
- Excellent adhesion - Avoids sagging

Part No.	Pack of	Size
SAS28	6	500ml Aerosols

SAS**S-A-S Red Paint - Post Office Red**

Tough acrylic formula paint for interior and exterior use.

- Suitable for use on wood, metal, glass, ceramic, paper, card and most plastics
- Professional fan spray - Adjustable nozzle for different spray patterns
- Excellent adhesion - Avoids sagging

Part No.	Pack of	Size
SAS30	6	500ml Aerosols

SAS**BEST SELLER****S-A-S Black Paint - Satin**

Tough acrylic formula paint for interior and exterior use.

- Suitable for use on wood, metal, glass, ceramic, paper, card and most plastics
- Professional fan spray - Adjustable nozzle for different spray patterns
- Excellent adhesion - Avoids sagging

Part No.	Pack of	Size
SAS25	6	500ml Aerosols

SAS**BEST SELLER****S-A-S White Paint - Gloss**

Tough acrylic formula paint for interior and exterior use.

- Suitable for use on wood, metal, glass, ceramic, paper, card and most plastics
- Professional fan spray - Adjustable nozzle for different spray patterns
- Excellent adhesion - Avoids sagging

Part No.	Pack of	Size
SAS31	6	500ml Aerosols

SAS**BEST SELLER****S-A-S Black Paint - Gloss**

Tough acrylic formula paint for interior and exterior use.

- Suitable for use on wood, metal, glass, ceramic, paper, card and most plastics
- Professional fan spray - Adjustable nozzle for different spray patterns
- Excellent adhesion - Avoids sagging

Part No.	Pack of	Size
SAS27	6	500ml Aerosols

SAS**BEST SELLER****S-A-S Silver Paint - Medium**

Tough acrylic formula paint for interior and exterior use.

- Suitable for use on wood, metal, glass, ceramic, paper, card and most plastics
- Professional fan spray - Adjustable nozzle for different spray patterns
- Excellent adhesion - Avoids sagging

Part No.	Pack of	Size
SAS29	6	500ml Aerosols

SAS**BEST SELLER****S-A-S Black Paint - VHT (Very High Temperature)**

Use on exhausts, manifolds and any surfaces which are subject to high temperatures.

- Fast drying aerosol paint with high covering power.
- Gives a tough durable coating and a matt finish.
- Petrol & oil resistant when cured.
- Withstands temps up to 650°C.

Part No.	Pack of	Size
SAS59	6	400ml Aerosols

Looking for Lane Marking Tapes?

A complete range of lane marking tapes are on Page 322

**Looking for Marking Crayons?**

A range of marking crayons can be found on page 239



SAS



S-A-S Line Marker

A permanent, quick drying and durable acrylic paint. Ideally suited for use with line marking equipment, stencils or for free hand application.

- Suitable For Use On: Concrete, tarmac, steel, grass and wood
- Quick drying, 30-40 minutes will withstand light traffic
- Through dry in 24 hours
- Areas Of Use: Car parks, road marking, warehouse and walkways, highway maintenance, utility services, sports fields, tennis courts and playgrounds



Part No.	Qty	Colour	Size
SAS40W	1	White	750ml Aerosol
SAS40Y	1	Yellow	750ml Aerosol
SAS40R	1	Red	750ml Aerosol
SAS40B	1	Blue	750ml Aerosol

Ambersil



BEST SELLER



AMBERSIL Acrylic Paint Marker Pens

Tenacious resin binds paint to the writing surface almost eliminating the problems associated with accidental rub-off and will not wash off with water/rain.

Part No.	Qty	Colour
AMB130	1	White
AMB131	1	Yellow
AMB132	1	Red
AMB133	1	Black

SAS



S-A-S Assorted Pack - Paint Aerosols 500ml

A selection of top quality paint aerosols, providing a professional finish each and every time. Plus the No. 1 selling Universal Maintenance Lubricant, ideal for everyday maintenance applications.

Part No.	Qty
SASP	Set of 6

6 x 500ml Aerosols: Zinc Spray, Satin Black Paint, Silver Paint, Grey Primer, Red Oxide Primer, Universal Maintenance Lubricant.

HMG

HMG Paints Ltd



HMG Floor Paint

Gloss finish. Coverage: 10m² per litre.

- Use on concrete, steel and wooden floors.
- Resistant to mild chemicals.

Part No.	Qty	Colour	Size	VOC Content
VC480	1	Safety Blue	5 Litres	High 25-50%
VC481	1	Safety Red	5 Litres	High 25-50%
VC482	1	Safety Yellow	5 Litres	High 25-50%
VC483	1	Black	5 Litres	High 25-50%
VC484	1	Dark Green	5 Litres	High 25-50%
VC485	1	Dark Grey	5 Litres	High 25-50%
VC486	1	White	5 Litres	High 25-50%

JOHNSTONE'S

TRADE



JOHNSTONE'S TRADE Professional Gloss Paint

VOC 2010 compliant. Solvent based.

Suitable for use on steel and metal.

- Optimum high gloss finish.

Part No.	Qty	Colour	Size
VC470	1	Black	5 Litres
VC471	1	Post Office Red	5 Litres



Looking for Paint Brushes?

The full range of paint brushes and rollers start from page 316





Tack Rags

For wiping surfaces prior to painting for a dust-free finish. Can be folded and refolded.

Part No.	Box of	Description
VC410	10	Tack Rags



4" Paint Roller Frame

Supplied WITHOUT Roller Refill.

Part No.	Qty	Description
PB100	1	4" Roller Frame



4" Paint Roller Refills

Part No.	Pack of	Type
PB101	10	Medium Pile (Emulsion)
PB102	10	Smooth Foam (Gloss)



4" Paint Roller Tray

Part No.	Qty	Description
PB103	1	4" Tray



4" Paint Roller Paint Tray Kit

Part No.	Qty	Description
PB104	1	4" Roller & Paint Tray Kit

Kit contains: 1 x 4" Roller Frame, 4" Paint Tray, 2 x Roller Refills: Medium Pile, Smooth Foam.

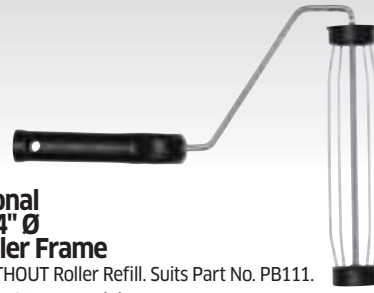

Professional 9" x 1 3/4" Ø Paint Roller Frame

Supplied WITHOUT Roller Refill. Suits Part No. PB111.

Part No.	Qty	Description
PB110	1	9" x 1 3/4" Ø Roller Frame



Professional 9" x 1 3/4" Ø Paint Roller Refill

Medium pile. Suits Part No. PB110.

Part No.	Qty	Description
PB111	1	9" x 1 3/4" Ø Roller Refill



9" Paint Roller Tray

Part No.	Qty	Description
PB112	1	9" Tray



General Purpose 9" x 1 1/2" Ø Paint Roller Tray Kit

Suits Part No. PB121

Part No.	Qty	Description
PB120	1	9" x 1 1/2" Ø Roller & Paint Tray Kit

Kit contains: 1 x 9" Roller Frame, 9" Medium Pile Roller Refill & 9" Tray.



General Purpose 9" x 1 1/2" Ø Roller Refills

Suits Part No. PB120

Part No.	Pack of	Check
PB121	3	9" x 1 1/2" Ø Roller Refills



Paint Brushes - Professional Plain Wooden Handles

Part No.	Pack of	Size	
PB48	8	1/2"	(12 mm)
PB51	4	1"	(25 mm)
PB49	3	1 1/2"	(38 mm)
PB52	2	2"	(50 mm)
PB53	1	3"	(75 mm)
PB54	1	4"	(100 mm)



BEST SELLER

Assorted Pack of Paint Brushes - Plastic Handles

Part No.	Pack of	Description
AP30	4 Pieces	Small Sizes

Sizes: 1/2", 1", 1 1/2", 2".



Assorted Pack of Paint Brushes - Plastic Handles

Part No.	Pack of	Description
AP31	3 Pieces	Large Sizes

Sizes: 2", 3", 4".



BEST SELLER

Paint Brushes - Budget Type for General Use

Part No.	Pack of	Size
PB1/2	12	1/2"
PB1	12	1"
PB1 1/2	12	1 1/2"
PB2	12	2"
PB3	12	3"
PB4	12	4"



BEST SELLER

Assorted Pack of Paint Brushes - Budget Type for General Use

Part No.	Pack of
AP19	10 Pieces

Sizes: 1/2", 1", 1 1/2", 2", 3".



Touch Up Brushes - Short Plain Wooden Handles

Part No.	Pack of	Size
PB62	12	No. 2
PB64	12	No. 4
PB66	12	No. 6
PB68	12	No. 8



BEST SELLER

Assorted Pack of Touch Up Brushes - Short Plain Wooden Handles

Part No.	Pack of
AP48	10 Pieces

4 x Size No.'s: 2, 4, 6, 8.



Assorted Pack of Touch Up Brushes - Plastic Handles

Part No.	Pack of
AP16	24 Pieces

3 x Size No.'s: 2, 4, 6.



White Spirit

- Conforms to BS 245.
- Thins solvent based paints.
 - Cleans paint brushes.
 - De-greases.

Part No.	Qty	Size
VC760	1	2 Litres



Looking for Masking Tapes

Our complete range of adhesive tapes start on Page 320

Looking for Paint Scrapers

Our complete range of scraping tools and blades can be found on Page 428



SAS



S-A-S Assorted Pack - Lubricant Aerosols 500ml

A selection of our fastest moving lubricant aerosols, including the No. 1 selling Universal Maintenance Lubricant used for a multitude of lubricating and maintenance applications.

Part No.	Qty
SASL	Set of 6
6 x 500ml Aerosols: White Grease with PTFE, Clear Grease, Silicone Spray, Chain & Cable Lube, Copper Grease, Universal Maintenance Lubricant.	

SAS



S-A-S Assorted Pack - Cleaning Aerosols 500ml

A selection of popular cleaning aerosols, plus the No. 1 selling Universal Maintenance Lubricant which can be used for a wide range of everyday cleaning applications.

Part No.	Qty
SASC	Set of 6
6 x 500ml Aerosols: Brake Cleaner, Throttle Body Cleaner, Electrical Cleaner, Label & Gum Remover, Leak Detector, Universal Maintenance Lubricant.	

SAS



S-A-S Assorted Pack - Valeting Aerosols 500ml

A selection of professional quality valeting aerosols, providing a clean finish for all vehicles. Plus the No.1 selling Universal Maintenance Lubricant, ideal for everyday maintenance applications.

Part No.	Qty
SASP	Set of 6
6 x 500ml Aerosols: Glass Cleaner, Cockpit Spray, Tyre Foam, Multi Purpose Foam Cleaner, Air Duster, Universal Maintenance Lubricant.	

SAS



S-A-S Assorted Pack - Paint Aerosols 500ml

A selection of top quality paint aerosols, providing a professional finish each and every time. Plus the No. 1 selling Universal Maintenance Lubricant, ideal for everyday maintenance applications.

Part No.	Qty
SASP	Set of 6
6 x 500ml Aerosols: Zinc Spray, Satin Black Paint, Silver Paint, Grey Primer, Red Oxide Primer, Universal Maintenance Lubricant.	



320



321



324



325



326



327

Sealants + Adhesives



327



328



328

- 320 Adhesive Tapes
- 324 Instant Adhesives
- 326 Threadlockers
- 327 Retainers
- 327 Epoxies
- 329 Repair Adhesives
- 332 Instant Gaskets
- 333 Silicone Sealants
- 335 MS-Polymer Sealants
- 335 Pipe Sealants
- 336 Exhaust Repair



328



329



330



332



333



333



335



336





Masking Tape - General Purpose

For temperatures up to 70°C (158°F). NOT suitable for use in bodysshops.

Part No.	Qty	Width x Length
VC411	36 Rolls	24 mm x 50 m
VC412	24 Rolls	48 mm x 50 m

Masking Tape - High Temperature

Sticks firmly and securely to most surfaces with clean removal.

- Good performance maintained on bake cycles of 127°C (260°F) for up to 1 hour.
- Designed for paint masking in automotive refinishing and industrial sectors.

Part No.	Qty	Width x Length
MT24	6 Rolls	24 mm x 50 m
MT48	6 Rolls	48 mm x 50 m



BEST SELLER

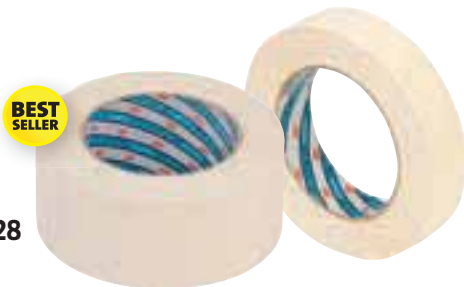

3M Scotch Auto® Masking Tape - 2328

- Solvent resistant
- Prevents bleed through

Part No.	Qty	Width x Length
MT225	9 Rolls	24 mm x 50 m
MT250	5 Rolls	48 mm x 50 m

Trim Masking Tape

High temperature rating: 100°C. Unique tape to mask up around rubber window surrounds and plastic panel trims.

- Perforated to make the job very quick.
- High temperature rating: 100°C.

Part No.	Pack of	Width x Length
MT11	1 Roll	48 mm x 10 m



Fine Line Tape - Green

High temperature rating: 150°C. Flexible and strong for masking around tight curves and sharp corners.

Part No.	Pack of	Width x Length
MT10	1 Roll	3 mm x 55 m

Double-Sided Adhesive Tape - Non-Foam Type

Avoids thickness build-up where foam tape has been previously used.

Part No.	Pack of	Width x Length
VC406	1 Roll	12 mm x 50 m
VC408	1 Roll	25 mm x 50 m



Transparent Marque Badge Tape

Transparent tape with strong acrylic adhesive. Adhesive thickness 0.04 mm. Application temperature: 15 to 35°C.

- A Simple, no fuss and very effective way to attach car logos and emblems back onto newly painted panels
- Tape is strong and will resist adverse weather conditions, oil and UV light.

Part No.	Pack of	Width x Length
MT12	10	50 x 300 mm Strips



BEST SELLER

Double-Sided Adhesive Foam Tape - Green Backing

Industrial standard general purpose tape. Suitable for interior and exterior use.

Part No.	Pack of	Width x Length	Thickness
VC402	1 Roll	12 mm x 10 m	0.8 mm
VC403	1 Roll	19 mm x 10 m	0.8 mm
VC404	1 Roll	25 mm x 10 m	0.8 mm
VC405	1 Roll	50 mm x 10 m	0.8 mm

BEST SELLER



Double-Sided Adhesive Foam Tape - Yellow Backing

Designed for automotive trim fixing.

- Delayed cure allows for repositioning where required.

Part No.	Pack of	Width x Length	Thickness
GLU10	2 Rolls	12 mm x 5 m	1.0 mm
GLU11	2 Rolls	19 mm x 5 m	1.0 mm
GLU24	2 Rolls	25 mm x 10 m	1.0 mm
GLU21	1 Roll	48 mm x 5 m	1.0 mm

BEST SELLER



ADVANCE 'AT132' Polycloth Duct Sealing Tape (Gaffer)

General purpose waterproof cloth tape.

- Easy unwind and easy tear
- Very high initial stick
- Gloss finish

Part No.	Qty	Colour	Width x Length
TAPE4	2 Rolls	Silver	50 mm x 50 m
TAPE4B	24 Rolls	Silver	50 mm x 50 m
TAPE5	2 Rolls	Black	50 mm x 50 m
TAPE5B	24 Rolls	Black	50 mm x 50 m
TAPE6	2 Rolls	White	50 mm x 50 m

Double-Sided Adhesive Pads - Mirror Pads

Part No.	Pack of	Size
VC400	40	40 x 28 mm



Double-Sided Adhesive Pads - Number Plate Pads

Part No.	Pack of	Size
VC401	20 x 3	80 x 25 mm



'Hook & Loop' Tapes - Black

Self-adhesive. 25 mm wide x 25 m long.

Part No.	Qty	Type
VC441	1 Roll	'Hook' Tape
VC442	1 Roll	'Loop' Tape

BEST SELLER



Gaffer Tape

General purpose waterproof cloth tape.

Part No.	Qty	Colour	Width x Length
TAPE7	2 Rolls	Silver	50 mm x 50 m
TAPE7B	24 Rolls	Silver	50 mm x 50 m
TAPE8	2 Rolls	Black	50 mm x 50 m
TAPE8B	24 Rolls	Black	50 mm x 50 m

NEW



Cold Weather Aluminium Foil Tape

Certified to BS476. Approved to class 'O' rating, used in the insulation marketplace on foil-faced pipe and slab sections and protects against the effects of fire, dust and moisture.

- Excellent in low temperature and humidity applications
- A soft, conformable aluminium foil conforms to irregular surfaces

Part No.	Qty	Width x Length
TAPE53	1	50 mm x 45.7 m

NEW



All Weather Clear Repair Tape

UV resistant polythene tape. Ideal for reinforcement of horticultural PVC structures and suitable for a variety of long-ageing applications.

- Outside UV resistant for 9 months
- Multi-purpose repairs - Polythene film, polytunnels, greenhouses, car lamps
- Designed for indoor and outdoor repairing and sealing applications

Part No.	Qty	Width x Length
TAPE54	3	50 mm x 10 m

NEW



Anti Corrosion Petro Tape

Apply by hand. For use on pipes, valves, joints and cables above and below ground. Seals against weathering and protects against water and chemicals.

- Highly impermeable to water and gases
- Used to protect buried or exposed pipes, valves, pipe fittings, cables and other metalwork from corrosion
- Non-hardening, non-cracking and highly resistant to deterioration

Part No.	Qty	Width x Length
TAPE50	1	50 mm x 10 m





Crossweave Tape

Clear polypropylene tapereinforced with crossweave glass fibre, coated with a synthetic rubber resin adhesive.

- High tensile strength for heavy duty bundling and packaging
- Recommended for packing of pallets and for high level reinforcements

Part No.	Qty	Colour	Width x Length
TAPE52	1 Roll	Clear	50 mm x 50 m



Wide Carton Sealing Tape

Clear polypropylene. Suitable for use with dispenser Part No. TAPE10.

- Low Noise

Part No.	Box of	Colour	Width x Length
TAPE11	24 Rolls	Clear	72 mm x 132 m



Wide Carton Sealing Tape Dispenser Gun

Suitable for use with Part No. TAPE11.

Part No.	Qty	Description
TAPE10	1	75 mm Tape Gun



Carton Sealing Tape

Brown polypropylene.

Suitable for use with dispenser Part No. TAPE3.

Part No.	Pack of	Colour	Width x Length
TAPE2	6 Rolls	Brown	50 mm x 60 m



Carton Sealing Tape Dispenser Gun

Suitable for use with Part No. TAPE2.

Part No.	Qty	Description
TAPE3	1	50 mm Tape Gun

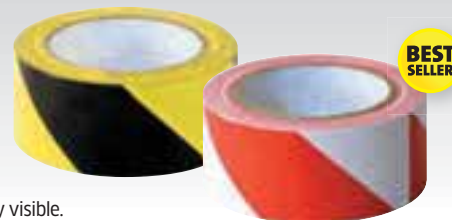

Hazard Warning Adhesive Tapes

50 mm x 33 m roll. Highly visible.

Suitable for use on concrete floors.

Part No.	Qty	Colours
TAPE24	1 Roll	Black/Yellow
TAPE25	1 Roll	White/Red

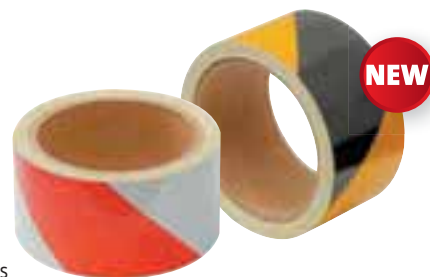

Reflective Tape

Class 1 commercial grade self adhesive tape for safety markings and barriers

- Ideal for the temporary road sign, safety markings and barriers, etc.
- Lasts for 3 to 5 years

Part No.	Qty	Colour	Width x Length
TAPE30	1 Roll	Red/White	50 mm x 10 m
TAPE31	1 Roll	Black/Yellow	50 mm x 10 m

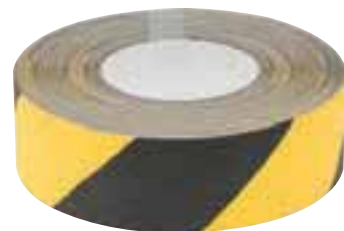

Anti-Slip Hazard Tape

Coarse grade.

Part No.	Qty	Colours	Width x Length
TAPE26	1 Roll	Black/Yellow	50 mm x 18.4 m



Lane Marking Tape

Self adhesive PVC.

Part No.	Qty	Colour	Width x Length
TAPE40	1	Red	50 mm x 33 m
TAPE41	1	Blue	50 mm x 33 m
TAPE42	1	Green	50 mm x 33 m
TAPE43	1	Yellow	50 mm x 33 m
TAPE44	1	Black	50 mm x 33 m
TAPE45	1	White	50 mm x 33 m



PVC Insulation Tape

Flame Retardant to BS EN 60454 Type 2.

Part No.	Pack of	Colour	Width x Length
EPT1	10	Black	19 mm x 20 m
EPT11	10	Blue	19 mm x 20 m
EPT17	10	Brown	19 mm x 20 m
EPT12	10	Green	19 mm x 20 m
EPT13	10	Green/Yellow Stripe	19 mm x 20 m
EPT18	10	Grey	19 mm x 20 m
EPT14	10	Red	19 mm x 20 m
EPT15	10	White	19 mm x 20 m
EPT16	10	Yellow	19 mm x 20 m



BEST SELLER

Assorted Pack of PVC Insulation Tape

19 mm Wide x 20 m Long. Flame Retardant to BS EN 60454 Type 2.

Part No.	Pack of
EPT3	10 Pieces

5 x Colours: (2 x) Blue, Green, Red, White, Yellow.



BEST SELLER

PVC Tape - 2" Wide

Part No.	Qty	Colour	Width x Length
EPT2	1	Black	50 mm x 33 m

ADVANCE



BEST SELLER

ADVANCE 'AT7' PVC Insulation Tape

Flame Retardant to BS EN 60454 Type 2.

Part No.	Pack of	Colour	Width x Length
EPT7	10 Rolls	Black	19 mm x 20 m

ADVANCE



ADVANCE High Temperature 'AT74' PVC Insulation Tape

Flame retardant, high temperature PVC electrical insulation tape. 0.15 mm Tape Thickness (150 Micron).

Part No.	Pack of	Colour	Width x Length
EPT74	10 Rolls	Black	19 mm x 33 m

Nitto



BEST SELLER

NITTO '21A' PVC Insulation Tape

0.20 mm Tape Thickness (200 Micron).

Part No.	Pack of	Colour	Width x Length
EPT21	10 Rolls	Black	19 mm x 20 m

NEW



Farmers 'Silage' High Strength PVC Tape

High strength tape for repairing around the farm including silage patching, electrical insulation and banding.

- Good resistance to abrasion, corrosion and moisture
- High dielectric strength
- Excellent conformability

Part No.	Qty	Colour	Width x Length
TAPE55	3 Rolls	Black	75 mm x 20 m

High Density PTFE Gas Tape

Manufactured to EN 751-3 GRp, BS 6920. WRAS approved.

- 33% thicker than standard PTFE tape.
- Developed especially for the gas industry.
- Suitable for use on all common gases and liquids.

Part No.	Pack of	Width x Length
GLU51	10 Rolls	12 mm x 5 m



PTFE Thread Sealing Tape

BS 4375. 751-3:1997.

Supplied on a plastic spool.

- For use on all materials: Steel, Alloy, Plastic, Copper and Ceramics.

Part No.	Pack of	Width x Length
GLU5	10 Rolls	12 mm x 12 m



BEST SELLER



LOCTITE



LOCTITE '401' Instant Adhesive

Universal Adhesive.

Part No.	Qty	Size
VC906	1	20g Bottle

LOCTITE



LOCTITE 'Precision' Super Glue

Supplied on a blister card.

Part No.	Qty	Size
VC935	1	5g Bottle

LOCTITE



LOCTITE 'Easy Brush' Super Glue

Supplied on a blister card.

Part No.	Qty	Size
VC934	1	5g Bottle

LOCTITE



LOCTITE 'All Plastics' Super Glue Kit

Extra strong formulation - Even for the most difficult plastics. Supplied on a blister card.

Part No.	Qty	Description
VC928	1 Kit	All Plastics Super Glue Kit

1 x Super Glue: 2g Tube. 1 x Activator Primer: 4ml Bottle.

LOCTITE



LOCTITE Super Glue Liquid

Universal instant adhesive. Supplied on a blister card.

- High performance formula.
- No clog pin cap.
- Bonds metal, rubber, wood, leather & most plastics.

Part No.	Qty	Size
VC933	1	3g Tube

LOCTITE



LOCTITE '319' Rear View Mirror Bonder

Supplied on a blister card.

Part No.	Qty	Size
VC929	1	0.5ml Bottle

LOCTITE



LOCTITE '3090' Multi-Substrate Adhesive

Colourless cyanoacrylate instant adhesive gel.

Complete with 7 nozzles.

- Bonds: Plastics, rubbers and metals.
- Also works on porous substrates: Wood, paper, leather, cork and fabrics.
- For applications with gaps up to 5 mm or where excess of adhesive is present.
- Fixing time: 90 - 150 seconds.

Part No.	Qty	Description
VC910	1	10g Dispenser Syringe Kit
VC911	10	Replacement Nozzles



SAS**BEST SELLER**

S-A-S Adhesive & Sealant Engineers Kit

Comprehensive kit containing the most frequently used adhesive and sealant products from the range. Supplied in a tough plastic storage case.

Part No. Description

SASKIT1 10 Piece Kit

Kit contents: 1 x Super Glue: 20g, 1 x Thread Lock: 10ml, 1 x Stud Lock: 10ml, 1 x Nut Lock: 10ml, 1 x Bearing Fit: 50ml, 1 x Instant Gasket, Blue: 100ml, 1 x Multi Gasket: 50ml, 1 x Brake & Airline Sealant: 50ml, 1 x High Strength Epoxy: 25ml, 1 x Quick Metal Liquid: 25ml.

SAS**BEST SELLER**

S-A-S Spray Adhesive

Can be applied to Roof Linings, Trim Linings, Upholstery and Carpets (NOT suitable for unsupported construction).

This product should NOT be used on surfaces where temperature may exceed 50°C.

- Specially formulated for maintenance and repair applications for all types of substrate and trim (except plasticised PVC)
- Non-chlorinated formula

Part No.	Pack of	Size
SAS470	6	500ml Aerosols

SAS**BEST SELLER**

S-A-S Super Glue

Medium viscosity. Bonds metal, rubber and most materials in seconds.

Part No.	Qty	Size
SAS401/5	Pack of 5	3g Tubes
SAS495/5	Pack of 5	5g Bottles
SAS495/24	Box of 24	5g Bottles
SAS4950	1	20g Bottle
SAS4950/12	Box of 12	20g Bottles

SAS**BEST SELLER**

S-A-S Super Glue Gel

Quick setting very thick non-drip gel adhesive. Ideal for applications requiring a viscous product, i.e. Vertical applications. Bonds metal, rubber and most materials in seconds.

Part No.	Qty	Size
SAS454	1	20g Tube
SAS454/20	Box of 20	20g Tubes

SAS**BEST SELLER**

S-A-S Super Glue - High Viscosity

High viscosity. Bonds metal, rubber and most materials in seconds.

Part No.	Qty	Size
SAS422	1	20g Bottle
SAS422/12	Box of 12	20g Bottles

SAS**BEST SELLER**

S-A-S Activator

Dramatically increases the cure speed of instant adhesives/super glue. Can also help the cure rate when used in large gaps and aids bonding on porous materials.

- Suitable for use on PVCU, plastic, glass and metal.

Part No.	Qty	Size
SAS325	1	200ml Aerosol



LOCTITE**LOCTITE '243' Threadlocker**

Fast-acting thread lock and sealant. Stops bolts, screws and nuts vibrating loose. Medium strength - Easily undone with normal hand tools. OEM Specified.

Part No.	Qty	Size
VC941	1	24ml Bottle
VC901	1	50ml Bottle

**LOCTITE****LOCTITE '270' Threadlocker**

Stud 'N Bearing Fit. Retains studs and bearings, sealing against corrosion. Vibration proof - Eliminates wear. OEM specified.

Part No.	Qty	Size
VC942	1	24ml Bottle
VC902	1	50ml Bottle

**LOCTITE****LOCTITE 'Stick 248' Threadlocker - Medium Strength**

Removable strength threadlocking adhesive, specially suited to fasteners between 1/4" and 3/4" diameter. Parts can be separated using hand tools.

Part No.	Qty	Size
VC971	1	19g Stick

**LOCTITE****LOCTITE 'Stick 268' Threadlocker - High Strength**

High strength threadlocking adhesive. Offering heavy duty strength and performance for high strength applications.

Part No.	Qty	Size
VC972	1	19g Stick

**SAS****S-A-S Thread Lock**

Prevents vibration loosening and leakage through threaded fastening. Designed for easy disassembly of treated components. Anaerobic formula allows curing only when confined between metal parts.

- **Strength: Low**
- **Gap Fill: 0.50 mm**
- **Suitable for use with oil, petrol and diesel**

Part No.	Qty	Size
SAS222/5	Pack of 5	10ml Bottles
SAS222/12	Box of 12	10ml Bottles
SAS2220	1	50ml Bottle
SAS2220/12	Box of 12	50ml Bottles

**SAS****S-A-S Nut Lock**

Prevents shock and vibration loosening and leakage on all types of metal fasteners. Designed for locking and sealing, Nut Lock withstands harsh environments yet is removable with hand tools.

- **Strength: Medium**
- **Gap Fill: 0.25 mm**
- **Temp Range: -40°C to +150°C**
- **Suitable for use with oil, petrol and diesel**

Part No.	Qty	Size
SAS243/5	Pack of 5	10ml Bottles
SAS243/12	Box of 12	10ml Bottles
SAS2430	1	50ml Bottle
SAS2430/12	Box of 12	50ml Bottles

**SAS****S-A-S Stud Lock**

Fast acting seal against leakage and corrosion. Chemical resistance against fuels, lubricants and gases. Eliminates double nutting and/or welding of critical assemblies.

- **Strength: High**
- **Gap Fill: 0.10 mm**
- **Temp Range: -50°C to +150°C**
- **Suitable for use with oil and petrol**

Part No.	Qty	Size
SAS271/5	Pack of 5	10ml Bottles
SAS271/12	Box of 12	10ml Bottles
SAS2710	1	50ml Bottle
SAS2710/12	Box of 12	50ml Bottles



SAS



S-A-S Bearing Fit

Provides medium strength retention under cyclic loading. Will retain full strength and not suffer fatigue under load stress, as well as benefiting from low corrosivity.

- **Strength: Medium**
- **Gap Fill: 0.20 mm**
- **Temp Range: Up to 150°C**
- **Full cure time: 12 hours**

Part No.	Qty	Size
SAS601	1	50ml Bottle
SAS601/12	Box of 12	50ml Bottles

SAS



BEST SELLER

S-A-S High Strength Retainer

Provides high strength retention under cyclic loading. Will retain full strength and not suffer fatigue under load stress, as well as benefiting from low corrosivity.

- **Strength: High**
- **Gap Fill: 0.20 mm**
- **Temp Range: Up to 150°C**
- **Full cure time: 24 hours**

Part No.	Qty	Size
SAS638	1	50ml Bottle
SAS638/12	Box of 12	50ml Bottles

SAS



BEST SELLER

S-A-S Quick Metal Liquid

Good matching qualities for bonding and repairing of most metals. Ideal for repair of metal housings and steel sheets.

- **Temperature Range: Up to 120°C (250°F)**
- **Cure Time: 45 minutes (Full Cure: 16 hours)**
- **Cured material can be filed, bored, tapped and over painted**

Part No.	Qty	Size
SAS380	1	25ml Syringe

SAS

BEST SELLER



S-A-S Rapid Epoxy

Quick setting, waterproof and impact resistant fluid epoxy resin adhesive.

- **Temperature range: Up to 50°C**
- **Cure time: 5 minutes (Full cure: 24 Hours)**

Part No.	Qty	Size
SAS450	1	25ml Syringe

SAS



S-A-S High Strength Epoxy

High strength, waterproof and impact resistant fluid epoxy resin adhesive.

- **Temperature range: Up to 42°C**
- **Cure time: 20 minutes (Full cure: 24 Hours)**

Part No.	Qty	Size
SAS460	1	25ml Syringe

SAS



BEST SELLER

S-A-S Quick Metal Putty

Kneadable epoxy repair putty. Ideal for long lasting emergency repairs. Adheres to moist surfaces even curing under water. Steel filled product resistant to corrosion.

- **Temperature Range: Up to +120°C**
- **Cure Time: 1 hour (Full Cure: 24 hours)**
- **Cured material can be filed, bored, tapped and over painted**

Part No.	Qty	Size
SAS390	1	112g Stick

SAS



S-A-S Quick Aluminium Putty

Epoxy putty for rebuilding damaged castings and worn parts.

- **Temperature Range: Up to +120°C**
- **Cure Time: 1 hour (Full Cure: 24 hours)**
- **Cured material can be filed, bored, tapped and painted over**

Part No.	Qty	Size
SAS391	1	114g Stick



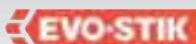

EVO-STIK 'Impact' Instant Contact Adhesive

Multi-Purpose. Instant bond on contact.

- Instant bond on contact.
- Bonds most materials, even non-porous.
- High strength - No need to support.
- Fast drying formula.

Part No.	Qty	Size
VC337	1	500ml Tin
VC336	6	65g Tube



ARALDITE 'Rapid' Super Strong Adhesive

Long lasting and solvent FREE. Water resistant and can be painted or sanded.

- Sets In Minutes.
- Bonds: Metal, Wood, Masonry, Ceramics, Glass, Most Plastics, Chipboard, Dry Concrete, Leather, Cardboard, Fabric and Rubber.

Part No.	Qty	Size
VC393	1	2 x 15ml Tubes
VC394	1	24ml Syringe



Glue Sticks

Suitable for use with Part No. TL880.

Part No.	Approx. Qty	Ø x Length	Weight
TL881	34 Sticks	12 x 300 mm	1 kg



PROVIDUS+ Glue Gun

80W, 230V. Suitable for use with Part No. TL881.

Part No.	Qty	Description
TL880	1	Glue Gun



J-B WELD Original Cold Weld

A remarkable easy, convenient and inexpensive alternative to welding, soldering and brazing. Bonds to virtually any clean, dry surface. Sets in 4-6 hours, cures in 16-24 hours. Supplied on a blister card.

- Maximum Temperature: 600°F (315°C).
- Tensile Strength: 3960 PSI.
- Cure Time: 16 hours.

Part No.	Qty	Pack of
VC391	1	2 x 28 g Tubes



J-B WELD Industrial Professional Size

Same product as J-B Weld in an industrial size pack. A remarkable easy, convenient and inexpensive alternative to welding, soldering and brazing. Bonds to virtually any clean, dry surface. Sets in 4-6 hours, cures in 16-24 hours.

- Maximum Temperature: 600°F (315°C).
- Tensile Strength: 3960 PSI.
- Cure Time: 16 hours.

Part No.	Qty	Box of
VC392	1	2 x 142 g Tubes



J-B WELD 'KwikWeld'

A fast-set, fast cure version of the original J-B Weld. A lightning 'kwik' bond with strength, perfect for any quick fix repairs. Sets in 4 Minutes, cures in 4-6 hours! Supplied on a blister card.

- Maximum temperature: 300°F (148°C).
- Tensile strength: 2424 PSI.
- Bonds In 4 Minutes!
- Cure Time: 4 hours.

Part No.	Qty	Pack of
VC395	1	2 x 28g Tubes



LOCTITE

LOCTITE 'Double-Bubble' Clear 5 Minute Epoxy

2K Epoxy. Supplied with mixing cards and sticks.

- Cure Time: 3-5 minutes at 20°C.

Part No.	Qty	Size
VC380A	10 Kits	3g Sachets
VC380	50 Kits	3g Sachets





PLASTIC PADDING 'Super Steel' Epoxy Weld

Hardens in 5 minutes.
Supplied on a blister card.

- Seals, Repairs, Fixes, Fills, Replaces.
- For use on Aluminium, Copper, Glass, Marble, Steel, Plastic, Stone, Wood, etc.

Part No.	Qty	Size
VC991	1	2 x 25g Tubes



Q-BOND Adhesive System Kits

Quick bonding, ultra strong adhesive system.
Black powder is carbon/graphite based designed for repairing hard plastics.
Grey powder is aluminium based designed for repairing metal surfaces.
Each pack contains: 2 x 10ml adhesive, 1 x black powder and 1 x grey powder.

- Non toxic
- Flexible when dry
- Resistant to chemicals, petrol, diesel, oil, coolant
- Withstands temperatures up to 180°C and pressures up to 1300psi
- Can be drilled, tapped, ground, sanded, primed, painted or powder coated 10 seconds after use

Part No.	Qty	Description
QB10	10 Kits	Q-Bond Kits c/w Display Box
QB10A	1 Kit	Q-Bond Kit



VIP 'PowerWeld' 2K Methacrylate

2-component structural adhesive (Methyl-Methacrylat-Ester) for bonding metal, modern difficult to bond plastics and innovative composites. Complete with 2 x mixer nozzles.

- High lapshear resistance
- Very good chemical resistance
- High temperature specification
- Non runny
- Partly no primer / no sanding
- Remains elastic
- Wide adhesion spectrum
- Very good working consistency
- Fills cuts and gaps up to 4mm
- Good reworkability (sanding, drilling, painting, etc.)
- UV stable

Part No.	Qty	Size
VIP52	1 Kit	25ml Cartridge



VIP 'Power Mix' - 1 Minute 2K Polyurethane Universal Repair Adhesive

2-part syringe cartridge.
Unique adhesive for plastic and metal components.
Cures in 1 minute (full cure time 24 hours).

Part No.	Pack of	Colour	Weight
VIP21B	2 Kits	Black	56g



**BEST
SELLER**



VIP 'Power Mix' - 5 Minute 2K Polyurethane Universal Repair Adhesive

2-part syringe cartridge.
Unique adhesive for plastic and metal components.
Cures in 5 minutes (full cure time 24 hours).

Part No.	Pack of	Colour	Weight
VIP25C	2 Kits	Clear	56g



**BEST
SELLER**

Applicator Nozzles

Suitable for 50ml 2-part syringe cartridges (suits Part No.s VIP25C & VIP21B).

Part No.	Pack of	Description
VIP37	12	Applicator Nozzles



Heavy Duty Applicator Gun

Suitable for 50ml
2-part syringe cartridges.

Part No.	Qty	Description
TL887	1	50ml Syringe Applicator Gun



VIP 'Power Mix' Primer

Adhesion promoter for most plastics, compound materials and a variety of surfaces. Developed to improve 2-part component adhesives performance, e.g. 'Power Mix'. Short drying time.

Part No.	Qty	Description
VIP35	1	150ml Aerosol





Our new range of MOTIP automotive putties can be used to repair many different surfaces such as steel, aluminium, wood, concrete, polyester & plastic bumpers



MOTIP 2 Component Filled Fibreglass Putty

2 component fibreglass putty for filling surface holes in steel, aluminium, wood, concrete and polyester. Fibre putty is easy to sand and has excellent filling properties. Fibre putty offers high impact resistance and may be resprayed with all paints. It is resistant to chemicals and weather influences and can be applied in layers up to 2 cm in thickness.

Part No.	Qty	Weight
MP9	1	250g



MOTIP 2 Component Polyester Repair Set

2 component polyester resin to be used in combination with the enclosed fibreglass mat and fibreglass fleece. To fill holes in surfaces of steel, aluminium, wood, concrete and polyester. Also suitable to create objects for which a mould is required. Polyester resin is elastic and resistant to chemicals and weather influences. MoTip Polyester Resin has excellent adhesion and is, after hardening, only mechanically sandable.

Part No.	Qty	Weight
MP7	1	250g

**NEW
RANGE**

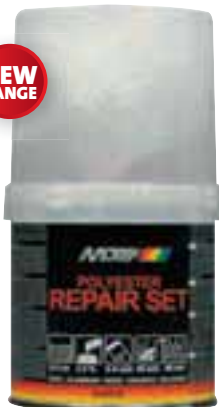

MOTIP 2 Component Polyester Putty

Universal 2 component polyester putty to level irregularities in surfaces of steel, aluminium, wood, concrete and polyester. Polyester Putty is elastic and very easy to sand. Polyester putty is re-sprayable with all lacquer systems and resistant to chemicals and weather influences. MoTip Polyester Putty can be applied in layers with a thickness up to 2 cm.

Part No.	Qty	Weight
MP1	1	250g



MOTIP 2 Component Polyester Resin

2 component polyester resin to be used in combination with fibreglass mat or fibreglass fleece. To fill holes in surfaces of steel, aluminium, wood, concrete and polyester. Also suitable to create objects for which a mould is required. Polyester resin is elastic and resistant to chemicals and weather influences. MoTip Polyester Resin has excellent adhesion and is after hardening only mechanically sandable.

Part No.	Qty	Weight
MP6	1	250g



MOTIP 2 Component Unfilled Fibreglass Putty

2 component fibreglass putty for filling surface holes in steel, aluminium, wood, concrete and polyester. Fibre putty has excellent filling properties. It offers high impact resistance and may be resprayed with all paints. It is resistant to chemicals and weather influences and can be applied in layers up to 2cm in thickness.

Part No.	Qty	Weight
MP8	1	250g



MOTIP 2 Component Bumper Repair Putty

2 component plastic putty to level irregularities in bumpers. Bumper repair putty is very elastic and easy to sand. Bumper repair putty can be resprayed with all paints, also powder coating, and has a very fine structure. Bumper repair putty is resistant to chemicals and weather influences and has excellent adhesion. MoTip Bumper Repair Putty can be applied in layers with a thickness up to 1 centimetre.

Part No.	Qty	Weight
MP2	1	250g



MOTIP 2 Component Metal Putty

2 component metal putty to level irregularities in surfaces of steel, aluminium, wood, concrete and polyester. As a result of the supplement of aluminium pigments, very easy to draw and consequently, ideal to treat larger surfaces. Metal putty is elastic and very easy to sand. Metal putty can be resprayed with all paints and resistant to chemicals and weather influences. MoTip Metal Putty can be applied in layers with a thickness up to 2 cm.

Part No.	Qty	Weight
MP4	1	250g



MOTIP 2 Component Fine Putty

2 component fine putty to level small irregularities in surfaces of steel, aluminium, wood, concrete and polyester. Fine Putty is easy to sand, elastic and resprayable with all lacquer systems. Fine Putty has a very fine structure and excellent adhesion and is resistant to chemicals and weather influences. MoTip Fine Putty can be applied in layers with a thickness up to 0.5 cm.

Part No.	Qty	Weight
MP3	1	250g



MOTIP Grey Finishing Putty (Tube)

Fast drying finishing putty to level small, superficial irregularities in surfaces of steel, aluminium, wood and polyester. Finishing putty has a fine structure and is easy to sand. MoTip Finishing putty is re-sprayable with all lacquer systems and can be applied in layers up to 0.5 millimetre.

Part No.	Qty	Weight
MP5	1	200g



MOTIP Fibreglass

Size: 0.5m²

Part No.	Qty	Type
MP10	1	Tissue
MP11	1	Fleece
MP12	1	Mat



Plastic Filler Spreader

Plain plastic.

- Ideal for use in automotive workshops, marine and boat industry, fibre glass and general industry.

Part No.	Pack of	Size
TL1001	10	70 x 106 mm

TEROSON UP 130 Chemical Metal

Repairs dents, pinholes and scratches. Can be drilled and tapped.

- Original hard, multi purpose, two part repair paste
- Resistant to water, oil, fuel, most weak acids and chemicals
- Pot life: 4:30 mins
- Colour: dark grey
- Sandable: 15 to 20 mins
- High chemical resistance

Part No.	Qty	Pack Size
VC994	1	321g



TEROSON UP 120 Leak Fix

Emergency repair of fuel tanks, leaking pipes, radiators etc.

- Two part, all purpose emergency filler
- Resistant to oil, water and common chemicals
- Pot Life: 3:30 mins
- Colour: grey/green/black
- Sandable: 15 to 20 mins
- Temperature resistance up to 120°C
- Good temperature resistance

Part No.	Qty	Pack Size
VC995	1	326g



SAS

BEST SELLER



S-A-S Multi Gasket

For sealing close fitting joints and flanged connections. Providing resistance to low pressures immediately after flange assembly.

- Temperature range: -55°C up to 150°C.
- Excellent water and oil resistance.
- Anaerobic formula allows curing only when confined between metal parts.
- Silicone Free.

Part No.	Qty	Size
SAS574	1	50ml Accordion Bottle
SAS574/12	Box of 12	50ml Accordion Bottles

LOCTITE



LOCTITE '574' Multi Gasket

Part No.	Qty	Size
VC940	1	50ml Bottle

LOCTITE



LOCTITE '5990' Silicone Copper Gasket Maker/Sealant.

• High performance.

Part No.	Qty	Size
VC951	1	100ml Tube

HYLOMAR



HYLOMAR 'Hylotype Red'

Semi hardening gasket and jointing compound. Supplied on a blister card.

- Resistant to steam.
- Operating temperature range: -40°C to 250°C.
- Resistant to automotive fluids: Petrol, oil, water and anti-freeze.

Part No.	Qty	Size
VC224	1	50g Tube

Granville



GRANVILLE Instant Gasket Silicone Sealant - Red 'Extra High Temp'

Compatible with catalytic converters.

- Extra high temperature up to 650°F (343°C) intermittent.

Part No.	Qty	Size
VC241	1	200ml Power Can

HYLOMAR



HYLOMAR 'Universal Blue' Gasket Compound

The original 'Blue Hylomar'.

Resistant to a wide range of fluids including all industrial fuels, oils, water and brine, air, turbine and piston engine combustion products, water, water/glycol and methanol mixtures, petroleum and synthetic diester lubricating oils, gasoline and kerosene fluids (Avtur & Avcat) and fluorocarbon refrigerants.

Part No.	Qty	Size
GLU12A	Pack of 3	40g Tubes
GLU12	Box of 12	40g Tubes
GLU4A	Pack of 3	100g Tubes
GLU4	Box of 12	100g Tubes

LOCTITE



LOCTITE '5926' Instant Gasket

Permanently flexible silicone sealant for gasket flanges of any shape and size. Sets very quickly. Ideal for a wide range of automotive applications.

Part No.	Qty	Size
VC952	1	40ml Tube

SAS

S-A-S High Temp Instant Gasket

For use as a gasket sealant to replace conventional gaskets. Waterproof formula seals leaks and can be used as an adhesive to bond metal, glass and rubber.

- Temperature range: -40°C up to 240°C (Intermittent).
- Excellent water and oil resistance.
- Resistant to Petrol.

Part No.	Qty	Size
SAS591	1	220ml Power Can

SAS

S-A-S Extra High Temp Instant Gasket

Red. High modulus flexible acetoxo.

- Replaces conventional gaskets
- Temperature range: -40°C to +350°C (intermittent)
- Compatible with catalytic converters
- Power can application
- Resistant to Petrol and Diesel

Part No.	Qty	Size
SAS592	1	220ml Power Can

SAS

S-A-S Instant Gasket - Blue

For use as a gasket sealant to replace conventional gaskets. Waterproof formula seals leaks and can be used as an adhesive to bond metal, glass and rubber.

- Temperature range: -40°C to 240°C (Intermittent)
- Excellent water and oil resistance
- Resistant to Petrol and Diesel

Part No.	Qty	Size
SAS590	1	100ml Tube
SAS590/12	Box of 12	100ml Tubes

SAS

S-A-S Instant Gasket - Clear

For use as a gasket sealant to replace conventional gaskets. Waterproof formula seals leaks and can be used as an adhesive to bond metal, glass and rubber.

- Temperature range: -40°C to +250°C (intermittent).
- Compatible with catalytic converters.
- Resistant to Petrol.

Part No.	Qty	Size
SAS593	1	100ml Tube
SAS593/12	Box of 12	100ml Tubes

**SAS**

S-A-S RTV Silicone Sealant

Premium quality specially formulated for automotive and industrial use. Bonds and seals metals, glass, rubber, etc. Flexible and resistant to transmission, cooling and lubricating fluids.

- Temperature range: -40°C up to 150°C
- Excellent water and good oil resistance
- Mildew resistant - suitable for sanitary applications

Part No.	Qty	Colour	Size
SAS202B/3	Pack of 3	Black	300ml Cartridges
SAS202B/12	Box of 12	Black	300ml Cartridges
SAS202C/3	Pack of 3	Clear	300ml Cartridges
SAS202C/12	Box of 12	Clear	300ml Cartridges
SAS202W/3	Pack of 3	White	300ml Cartridges
SAS202W/12	Box of 12	White	300ml Cartridges

Assorted Pack of Cartridge Nozzles

Suitable for most 300/310ml cartridges

Part No.	Description
SASNOZ	Pack of 12

2 x Colours: Black, Clear, White.

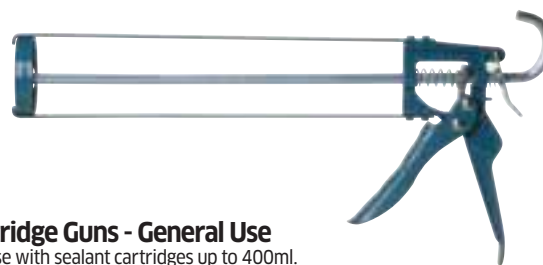

Cartridge Guns - General Use

For use with sealant cartridges up to 400ml.

Part No.	Pack of	Description
TL921	2	General Use Gun

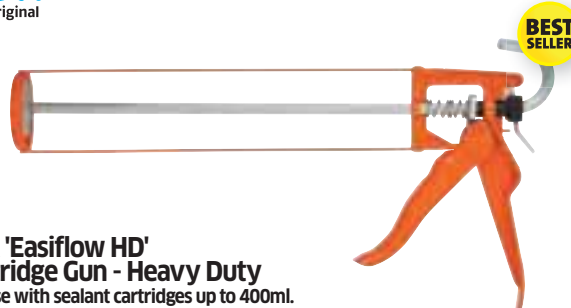
COX
The original

COX 'Easiflow HD' Cartridge Gun - Heavy Duty

For use with sealant cartridges up to 400ml.

Part No.	Qty	Description
TL885	1	Heavy Duty Gun

Silicone Sealants



Geocel



GEOCEL 'Auto' Silicone

For sealing windscreens and making permanent replacement instant gaskets.

Part No.	Pack of	Size
VC247	6	78g Injector Cartridge



SIROFLEX 'Polyflex-HM' Polyurethane Sealant

300ml cartridge.

Part No.	Qty	Colour
VC203B	Pack of 3	Black
VC203BB	Box of 12	Black
VC203W	Pack of 3	White
VC203WB	Box of 12	White



Cartridge Guns - General Use

For use with sealant cartridges up to 400ml.

Part No.	Pack of	Description
TL921	2	General Use Gun

COX
The original

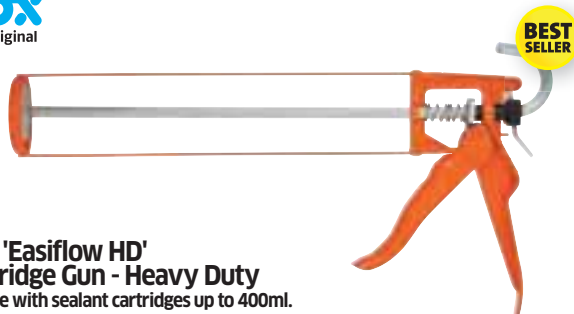

COX 'Easiflow HD' Cartridge Gun - Heavy Duty

For use with sealant cartridges up to 400ml.

Part No.	Qty	Description
TL885	1	Heavy Duty Gun

DEN BRAVEN 'Gasket - Sealant' High Temperature Silicone Sealant

Designed for forming gasket joints where an extremely high temperature resistance is necessary.

- Trade strength.
- Resistance up to 300°C.

Part No.	Pack of	Colour	Size
VC204	3	Red	310ml Cartridges



Assorted Pack of Cartridge Nozzles

Suitable for most 300/310ml cartridges

Part No.	Description
SASNOZ	Pack of 12

2 x Colours: Black, Clear, White.



SIROFLEX Expanding Foam

Trade strength.

Part No.	Qty	Size
VC205	1	700ml Aerosol

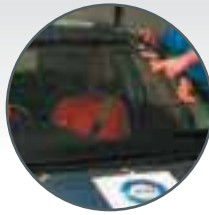

VIP 'Power Bond' Windscreen MS-Polymer Sealant/Bonder

A unique sealing and bonding mastic of the new generation high-quality hybrid polymers

- 2 hour drive-away time.
- Suitable for use with integrated windscreen antenna.
- Cures under the influence of air.
- Can be painted after 15 minutes, even when wet.
- Fast drying, contains no isocyanates, solvents or silicone.
- Remains flexible.
- TÜV approved.



Part No.	Qty	Colour	Size
VIP13B	1	Black	310ml cartridge
VIP13BB	12	Black	310ml cartridges

VIP 'Power Bond' Seam Sealer 1K MS-Polymer Sealant/Bonder

A unique sealing and bonding mastic of the new generation high-quality hybrid polymers.

- Cures under the influence of air.
- Can be painted after 15 minutes, even when wet.
- Fast drying, contains no isocyanates, solvents or silicone.
- Remains flexible.



Part No.	Qty	Colour	Size
VIP10B	1	Black	310ml cartridge
VIP10B/10	10	Black	310ml cartridges
VIP10C	1	Clear	310ml cartridge
VIP10C/10	10	Clear	310ml cartridges
VIP10G	1	Grey	310ml cartridge
VIP10G/10	10	Grey	310ml cartridges
VIP10W	1	White	310ml cartridge
VIP10W/10	10	White	310ml cartridges

VIP Black Windscreen Activator Primer for Sealant/Bonder

For use with 'Power Bond S' (Part No. VIP13B).

Part No.	Qty	Description
VIP33	1	38ml Bottle



S-A-S Brake & Air Line Sealant with PTFE

Instant low pressure sealant for fine and coarse threads up to 3 inch in diameter. Cures up to 60 hours after application, allowing for re-alignment of joints. Will not shred or tear. PTFE seals against oils, gases, chemicals.

- Strength: Medium.
- Gap Fill: 0.40 mm.
- Petrol resistant.

Part No.	Qty	Size
SAS572	1	50ml Accordion Bottle
SAS572/12	Box of 12	50ml Accordion Bottles

BEST SELLER



LOCTITE '572' Brake & Air Line Thread Sealant

Seals and locks. Low strength.

Part No.	Qty	Size
VC945	1	50ml Bottle



High Density PTFE Gas Tape

Manufactured to EN 751-3 GRp, BS 6920. WRAS approved.

- 33% thicker than standard PTFE tape.
- Developed especially for the gas industry.
- Suitable for use on all common gases and liquids.

Part No.	Pack of	Width x Length
GLU51	10 Rolls	12 mm x 5 m



PTFE Thread Sealing Tape

BS 4375. 751-3:1997.

Supplied on a plastic spool.

- For use on all materials: Steel, Alloy, Plastic, Copper and Ceramics.

Part No.	Pack of	Width x Length
GLU5	10 Rolls	12 mm x 12 m



BEST SELLER



SAS**BEST
SELLER****S-A-S Exhaust Assembly Paste**

Eases exhaust assembly and seals all joints.

- **Silicone free.**

Part No.	Pack of	Size
SAS210/6	6	500g Cartridges
SAS210/12	12	500g Cartridges

SAS**S-A-S Exhaust Repair Putty**

Specially designed for the lubrication and assembly of exhaust systems. Asbestos free and formulated to withstand pressures and temperatures commonly found in vehicle exhaust systems.

- **Temperature range: Up to 1,000°C.**

Part No.	Qty	Size
SAS220	1	200g Tub
SAS220/12	Box of 12	200g Tubs

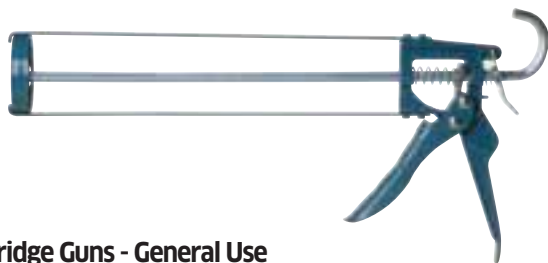
**Cartridge Guns - General Use**

For use with sealant cartridges up to 400ml.

Part No.	Pack of	Description
TL921	2	General Use Gun

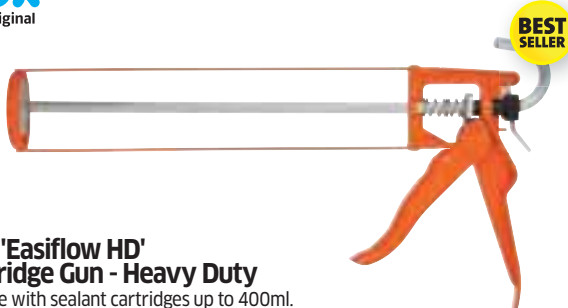
COX
The original**COX 'Easiflow HD' Cartridge Gun - Heavy Duty**

For use with sealant cartridges up to 400ml.

Part No.	Qty	Description
TL885	1	Heavy Duty Gun

Holts**HOLTS 'Firegum'**

Eases exhaust assembly and seals all joints. Specially formulated for the assembly of all exhaust systems as well as flues and boiler pipes.

- **100% carbon monoxide proof.**
- **Withstands temperatures of up to 1000°C.**

Part No.	Pack of	Size
VC215	12	75g Tubes

**Holts****HOLTS 'Gun Gum' Silencer Repair Paste**

Quick, simple and easy to use. Repairs holes in silencers with a gas tight seal. The hotter it gets the harder it gets!

Part No.	Pack of	Size
VC216	12	200g Tins

**HYLOMAR****HYLOMAR 'EAP5' Exhaust Assembly Paste**

For efficient leak-proof exhaust systems.

- **Asbestos free.**
- **Withstands 1000°C.**
- **Smooth texture for easy working.**

Part No.	Pack of	Size
VC211	12	140g Tubes

**HYLOMAR****HYLOMAR 'ERP2' Exhaust Repair Putty**

For efficient leak-proof repairs.

- **Asbestos free.**
- **Withstands 1000°C.**
- **Smooth texture for easy working.**

Part No.	Pack of	Size
VC212	12	250g Tubs





338



341



343



344



347



349



Hygiene + Safety



351



355



357

- 338 Hand Care
- 344 Hand Wipes
- 346 Janitorial
- 351 Vacuum Spares
- 354 Liquid Handling
- 360 Spillage Control
- 362 First Aid
- 363 Fire Safety
- 364 Safety Signage
- 374 Disposable Gloves
- 375 Gloves
- 377 Head Protection
- 378 Eye Protection
- 380 Respiratory Protection
- 382 Hearing Protection
- 384 Safety Clothing
- 386 Safety Boots + Footwear
- 388 Safety At Height



360



362



365



374



378



381



383



386



ROZALEX®

ROZALEX 'Medsan' Sanitising Cream

An alcohol free hand sanitiser lotion which also moisturises and acts as a light duty barrier cream. Chlorhexidine based for broad and safe bug killing properties. Once applied the quick drying, non greasy formula keeps killing bugs for up to 2 hours making ideal for use with food preparation or healthcare.

- Hand Sanitiser & Moisturiser
- Alcohol FREE
- Works For 2 Hours After Application
- Non-Greasy

Part No.	Qty	Size
RZ1001	1	250ml Dispenser Bottle



ROZALEX®

ROZALEX 'Dri-Guard'® Barrier Cream

General purpose dry work barrier cream. Designed to give protection against everyday materials such as mineral oils, solvents, dust, grease, factory grime, cement and dry work in industry.

- Contains lanolin derivative
- Gives protection against solvent and oil based contaminants
- Facilitates soil removal from skin

Part No.	Qty	Size
RZ1004	1	450ml Tub
RZ1005	1	5 Ltr Bucket



ROZALEX®

ROZALEX 'Rozsan' Sanitising Gel

High quality BS-EN approved hand sanitiser. Suitable for use in hospitals, nursing homes, schools and food preparation applications. Certified for use against MRSA, eColi, c-Diff, Listeria and Salmonella.

- BS-EN approved high quality alcohol gel
- Better quality alcohol gives improved skin feel after use
- Can be used in Food preparation and Healthcare applications
- Quick drying

Part No.	Qty	Size
RZ1002	1	500ml Dispenser Bottle



ROZALEX®

ROZALEX 'Wet-Guard'® Barrier Cream

A general purpose wet work barrier cream. Designed to give protection against everyday materials such as neat and soluble cutting oils, dilute alkali and acids, detergents, coolants, wet cements and other water/oil based materials in industry.

- Water repellent
- Gives protection against water based materials and contaminants
- Can be used as a general purpose barrier cream
- Suitable for use under gloves

Part No.	Qty	Size
RZ1104	1	450ml Tub



SAS



S-A-S Hand Sanitiser Gel

Waterless alcohol base gel.

- Non-irritant formulation
- Kills 99.9% of bacteria

Part No.	Qty	Size
SAS530	1	500ml Dispenser Bottle



SAS

S-A-S Barrier Cream

An essential pre-work tool in preventing irritating skin conditions and infections, its powerful non-greasy action protects the skin against paints, resins, epoxies, inks and tars.

Part No.	Pack of	Size
SAS500	4	1 Litre Bottles



ROZALEX®

ROZALEX 'Xworx'® Reconditioning Cream

A quality reconditioning cream that enables the skin to re-hydrate & replenish natural oils lost during the day.

- Non-coloured, non-perfumed & non-greasy
- Prevents dry and cracked skin - a key cause of dermatitis
- Especially suitable for sensitive skin
- Keeps hands supple and flexible for safer and more efficient handling of tools and machinery

Part No.	Qty	Size
RZ3004	1	450ml Tub



ROZALEX®



**ZALPON 'Zing'
Citrus Gel Hand Cleaner
- Heavy Duty**

A 100% solvent free heavy duty gel hand cleaner which features walnut scrub and moisturisers to clean working hands and leave them feeling soft with a unique triple citrus fragrance.

- Removes: Oil, Grease, Paint & Grime
- Heavy Duty Cleaning Action
- Includes Walnut Scrub & Moisturisers



Part No.	Qty	Size
RZ2011	6	1 Litre Dispenser Bottle
RZ2014	4	4 Litre Pump Pack

ROZALEX®



**ZALPON 'Zorange'
Orange Pumice Gel
Hand Cleaner -
Extra Heavy Duty**

An extra heavy duty hand cleaner for ingrained dirt and oils. Containing natural orange oils, moisturisers, esters and pumice for a deep clean without drying the skin.

- Extra Heavy Duty Hand Cleaner
- Contains Natural Orange Oils
- Ideal For Heavily Ingrained Hands



Part No.	Qty	Size
RZ2001	6	1 Litre Dispenser Bottle
RZ2004	4	4 Litre Pump Pack

Swarfega

**SWARFEGA® 'Heavy'
Hand Cleaner
- Heavy Duty**

Heavy duty gel formula containing non-abrasive natural scrubbing granules and added conditioner to quickly remove deeply ingrained oil and grease soilings and leave the skin feeling smooth after use.

- Deep cleaning
- Added conditioner
- Fresh fragrance



Part No.	Qty	Size
DEB15	1	15 Litre Bucket



**DREUMEX 'Classic'
Red Hand Cleansing Gel**

Hand cleansing gel for medium soilings such as oil, fats, grease, bitumen and rubber. Contains solvents. Ideal for use in garages, workshops and metalworking industry.

- Increased cleaning power because of skin friendly Silica micrograins
- Skin friendly - Dermatologically tested and approved

Part No.	Qty	Size
VC706	1	600ml Tub
VC705	1	4.5 Litre Tin
VC715	1	15 Litre Bucket

Swarfega



**SWARFEGA® 'Orange'
Hand Cleanser - Heavy Duty**

Advanced formulation, solvent-free heavy duty hand cleanser containing non-abrasive scrubbers for a deep-down cleaning action and moisturiser to help care for the skin. Removes ingrained oil, grease and general grime.

Part No.	Qty	Size
DEB74PP	4	4 Litre Pump Pack
DEB75	1	15 Litre Bucket

NEW

**Antibacterial
Hand Soap**

A mild yet effective formulation which leaves hands soft and clean and is suitable for regular use.

- Kills 99.99% of germs
- Specially formulated and enriched with moisturiser
- Gentle and effective



Part No.	Qty	Pack Size
VC506	1	485 ml Bottle
VC507	1	5 Litre Container



SAS

S-A-S Foam Hand Cleaner

A ready to use high quality, anti-bacterial, foaming hand & skin cleanser.

- Excellent cleaning performance yet gentle on the skin
- Does not contain petroleum or natural solvents
- A water based blend of non-ionic surfactants
- Kills germs and bacteria
- Pleasant fragrance

Part No.	Qty	Size
SAS543	12	600ml Pump Bottle



SAS

S-A-S Pink Pearl Hand Cleaner

A ready to use rich lotion hand cleanser designed for general purpose / washroom.

- Can be poured into a 1 Litre Dispenser
- Does not contain petroleum or natural solvents
- A water based blend of non-ionic surfactants
- Excellent cleaning performance yet gentle on the skin
- Pleasant Jasmine fragrance leaves hands smelling fresh & clean

Part No.	Qty	Size
SAS541	6	1 Litre Bottle



SAS

S-A-S Industry Gold Hand Cleaner

Engineering grade general purpose, solvent-free clear golden gel hand and skin cleanser with light orange fragrance.

- Can be poured into a 1 Litre Dispenser
- Does not contain petroleum or natural solvents
- A water based blend of natural soaps
- Can be used with or without water
- Excellent cleaning performance yet gentle on the skin
- Pleasant Orange fragrance, leaves hands feeling soft, fresh & clean

Part No.	Qty	Size
SAS542	6	1 Litre Bottle



SAS

S-A-S Soap Dispenser Unit

For bulk-filling. Dispenser can be used for most hand soap products. Wall Mounting. Complete with wall mounting fixings.

NOT suitable for use with beaded hand gels.

Part No.	Qty	Description
SAS540	1	1 Litre Dispenser Unit



SAS

Hand Care - Selection Guide

	Natural Mousse Scrub	Red Tough Grit Gel	Orange Pumice Gel	Citrus Sream Scrub
Fragrance :	Lavender	Industrial	Orange	Citrus
Type :	Mousse	Thick Gel	Light Gel	Cream
Category :	Medium Duty	Heavy Duty	Heavy Duty	Extra Heavy Duty
Sizes :	3 L / 10 L	5 L / 15 L	3 L / 10 L	3 L / 10 L

Effectively Removes :

	Natural Mousse Scrub	Red Tough Grit Gel	Orange Pumice Gel	Citrus Sream Scrub
Grime	✓✓✓	✓✓✓	✓✓✓	✓✓✓
Grease	✓✓	✓✓✓	✓✓✓	✓✓✓
Ingrained Oil	✓✓	✓✓✓	✓✓✓	✓✓
Paints	✓	✓✓	✓✓	✓✓✓
Inks	✓	✓✓	✓✓	✓✓✓
Dyes	✓	✓✓	✓✓	✓✓✓
Tar / Glue	✓	✓✓	✓✓✓	✓✓✓

Contains :

	Natural Mousse Scrub	Red Tough Grit Gel	Orange Pumice Gel	Citrus Sream Scrub
Corn Scrub				✓
Pumice		✓	✓	
Wood Flour / Walnut Scrub	✓			

SAS

S-A-S Abrasive Hand Wipes

Extra heavy duty textured hand and skin wipes impregnated with an effective cleansing solution.

- Abrasive & smooth sides allow scrubbing & wiping
- Also suitable for cleaning tools
- Non-scratching
- Pleasant orange fragrance leaves hands smelling fresh and clean
- Wipes stay fresh and moist for up to 18 months after opening
- Alcohol content 1-10%

Part No.	Qty	Size
SAS527	1	Bucket of 100 Wipes



SAS

S-A-S Non-Abrasive Hand Wipes

Heavy duty hand and skin wipes impregnated with an effective cleansing solution.

- Also suitable for cleaning tools
- Non-scratching
- Pleasant orange fragrance leaves hands smelling fresh and clean
- Alcohol content 1-10%

Part No.	Qty	Size
SAS520	1	Bucket of 150 Wipes

BEST SELLER



SAS



S-A-S Red Tough Grit Gel Hand Cleaner - Heavy Duty

A water based blend of non-ionic surfactants, soap and refined petroleum solvent.

- Traditional gel cleanser
- Utilises best quality odourless kerosene
- Natural scrubbing agent pumice provides maximum dirt removal
- Pleasant industrial fragrance
- Non-poly-bead formulation

Part No.	Qty	Size
SAS505	1	5 Litre Bucket
SAS515	1	15 Litre Bucket

SAS



S-A-S Natural Mousse Scrub Hand Cleaner - Medium Duty

A medium duty, water based and solvent-free hand cleaner suitable for use on damaged skin. Contains wood flour, walnut scrub and lavender oil for enhanced protection.

- Solvent-free formula - Does not contain petroleum
- Natural scrubs - provides a skin-Friendly scrub to aid dirt removal
- Contains lavender oil - Leaves a pleasant 'fresh and clean' light fragrance
- Suitable for use on damaged skin - Leaving it feeling smooth and cared for

Part No.	Qty	Size
SAS501A	1	3 Litre Tub
SAS501	6	3 Litre Tubs
SAS502	1	3 Litre Pump
SAS503	1	3 Litre Tub Wall Bracket
SAS511	1	10 Litre Container
SAS512	1	10 Litre Pump

SAS

BEST SELLER



S-A-S Orange Pumice Gel Hand Cleaner - Heavy Duty

A ready to use natural solvent based extra heavy-duty hand cleaner with pumice for enhanced skin cleaning.

- A water based blend of natural solvents, surfactants and pumice
- Maximum performance on ingrained oils
- Pumice ensure maximum dirt removal
- Pleasant citrus fragrance leaves hands smelling fresh & clean

Part No.	Qty	Size
SAS506A	1	3 Litre Tub
SAS506	6	3 Litre Tubs
SAS502	1	3 Litre Pump
SAS503	1	3 Litre Tub Wall Bracket
SAS516	1	10 Litre Container
SAS512	1	10 Litre Pump

SAS



S-A-S Citrus Cream Scrub Hand Cleaner - Extra Heavy Duty

Extra heavy duty hand cleaner with moisturisers and natural scrubbing agent.

Specifically formulated for the effective removal of:

- Ingrained Oil
- Inks
- Grime
- Dyes
- Grease
- Paints
- Tar

Part No.	Qty	Description
SAS504A	1	3 Litre Tub
SAS504	6	3 Litre Tubs
SAS502	1	3 Litre Pump
SAS503	1	3 Litre Tub Wall Bracket
SAS514	1	10 Litre Container
SAS512	1	10 Litre Pump





DEB Dispenser Units

Suits all DEB (except DEB142) and SWARFEGA cartridges. Supplied empty.

Part No.	Qty	Description
DEB2	1	2 Litre Dispenser Unit
DEB4	1	4 Litre Dispenser Unit



**DEB 'Estesol'®
 Blue Lotion Hand Cleanser
 - Light Duty**

Light duty lotion hand cleaner with a light, pleasant unisex fragrance.

- Contains glycerin
- Skin hypoallergenic
- Silicone-free
- Ideal for frequent use to remove general workplace dirt and grime

Part No.	Qty	Description
DEB112	1	2 Litre Cartridge
DEB112C	4	2 Litre Cartridges
DEB114	1	4 Litre Cartridge
DEB114B	4	4 Litre Cartridges



**DEB 'Kresto'®
 Citrus Hand Cleanser
 - Heavy Duty**

A powerful citrus hand cleaner.

- Non-abrasive natural cornmeal hand scrub
- Contains orange oil
- Removes difficult to remove soiling including inks, most adhesives, oil based paints, oil, grease and grime

Part No.	Qty	Description
DEB22	1	2 Litre Cartridge
DEB22C	4	2 Litre Cartridges
DEB24	1	4 Litre Cartridge
DEB24B	4	4 Litre Cartridges



**DEB 'Skin Protection Centre'
 2 Litre, 4 Litre & 2 x 1 Litre Dispenser Units**

Robust lightweight boards containing DEB dispensers to provide effective 3-Step Skin Safety Programme. Dimensions (W x H): 800 mm x 570 mm. Supplied empty.

- Everything you need for clean healthy skin in the most appropriate location
- Easy to install, easy to maintain
- Recommended contents: Step 1: 1L = DEB81. Step 2: 2L = DEB112 or DEB32. Step 3: 4L = DEB34, DEB24 or Swarfega DEB74. Step 4: 1L = DEB91.

Part No.	Qty	Description
DEB6	1	Skin Safety Centre



**DEB 'Solopol'®
 Lime Hand Cleanser
 - Medium Duty**

A powerful medium duty cream hand cleaner.

- Non-abrasive natural cornmeal hand scrub
- Contains lime extracts
- Removes industrial soiling, oil, grease and general dirt and grime

Part No.	Qty	Description
DEB32	1	2 Litre Cartridge
DEB32C	4	2 Litre Cartridges
DEB34	1	4 Litre Cartridge
DEB34B	4	4 Litre Cartridges



**DEB 'Solopol'® GFX™
 Foaming Gritty Hand
 Cleanser - Heavy Duty**

Heavy duty gritty power foam hand cleaner with non-abrasive natural scrubbing agents.

- Lightly fragranced, solvent-free formulation is twice as effective as traditional heavy duty soaps
- Efficient foam formula provides over 43% more hand washes compared with traditional hand cleansers
- Removes ingrained oil, grease, carbon black & lubricants

Part No.	Qty	Description
DEB142	1	3.25 Litre Cartridge
DEB142B	4	3.25 Litre Cartridges
DEB3	1	3.25 Litre Heavy Duty Dispenser Unit



DEB 'InstantFOAM' Complete Foaming Hand Sanitiser

Kills 99.999% of many common germs and is fully tested and proven to be bactericidal, virucidal, yeasticidal and mycobactericidal.

- Quick and easy to apply - No water required
- Skin conditioners leave hands feeling soft and smooth
- Hypo allergenics minimise the risk of allergic reactions
- No gelling agents or polymers that leave a sticky residue on hands

Part No.	Qty	Size
DEB201	1	1 Litre Cartridge
DEB201B	6	1 Litre Cartridges
DEB200	1	1 Litre Dispenser Unit



DEB 'Stokoderm'® Protect Pure' General Skin Protection Cream

Extra protection skin cream.

- Pre-work protective and reconditioning cream
- Protects the skin against contact with water and non-water based contaminants
- For wet and dry work

Part No.	Qty	Size
DEB80A	1	100ml Bottle
DEB81	1	1 Litre Cartridge
DEB81B	6	1 Litre Cartridges
DEB1	1	1 Litre Dispenser Unit



DEB 'Stokolan'® Classic' After-Work Conditioner Cream

Apply at the end of each work period to moisturise skin.

- A mild, super-hydrating after work conditioning cream
- Increases skin moisture by approximately 60%

Part No.	Qty	Size
DEB90A	1	100ml Bottle
DEB91	1	1 Litre Cartridge
DEB91B	6	1 Litre Cartridges
DEB5	1	1 Litre Dispenser Unit



Swarfega

SWARFEGA® 'Orange' Hand Cleanser - Heavy Duty

Advanced formulation, solvent-free heavy duty hand cleanser containing non-abrasive scrubbers for a deep-down cleaning action and moisturiser to help care for the skin. Removes ingrained oil, grease and general grime.

- Added moisturisers
- Fresh orange fragrance
- Dermatologically tested
- Toxicological approval

Part No.	Qty	Size
DEB74	1	4 Litre Cartridge
DEB74B	4	4 Litre Cartridges
DEB7	1	4 Litre Dispenser Unit



NEW

BEST SELLER

Swarfega



BEST SELLER

BEST SELLER

SWARFEGA® 'Orange' Hand Cleanser - Heavy Duty

Advanced formulation, solvent-free heavy duty hand cleanser containing non-abrasive scrubbers for a deep-down cleaning action and moisturiser to help care for the skin. Removes ingrained oil, grease and general grime.

Part No.	Qty	Size
DEB74PP	4	4 Litre Pump Pack
DEB75	1	15 Litre Bucket

Swarfega

SWARFEGA® 'Heavy' Hand Cleaner - Heavy Duty

Heavy duty gel formula containing non-abrasive natural scrubbing granules and added conditioner to quickly remove deeply ingrained oil and grease soilings and leave the skin feeling smooth after use.

- Deep cleaning
- Added conditioner
- Fresh fragrance

Part No.	Qty	Size
DEB15	1	15 Litre Bucket





SCRUBS-IN-A-BUCKET Alcohol Free Hand Cleaner Towels

Fast one-step process hand cleaning towels.

- Does not transfer soil back onto hands
- Quickly removes: Dirt, Oil, Tar, Adhesives, Lubricants, Grease, Urethanes, Epoxies, Sealants, Paints, Inks and Dyes
- Can also be used on: Tools, Plastics, Painted Surfaces, Work Surfaces, Metals, Vinyls and Equipment
- Unique alcohol free formula leaves hands feeling moisturised not dry

Part No.	Qty	Description
VC534	1	Tub of 72



SAS

S-A-S Abrasive Hand Wipes

Extra heavy duty textured hand and skin wipes impregnated with an effective cleansing solution.

- Abrasive & smooth sides allow scrubbing & wiping
- Also suitable for cleaning tools
- Non-scratching
- Pleasant orange fragrance leaves hands smelling fresh and clean
- Wipes stay fresh and moist for up to 18 months after opening
- Alcohol content 1-10%

Part No.	Qty	Size
SAS527	1	Bucket of 100 Wipes



GRIME-EEZ® Multi-Wipes

Hand wipes for general applications in industrial environments including engineering, printing, mechanics and plumbing. Supplied in a re-sealable tub.

- Low alcohol based antibacterial cleaning solution
- Leaves skin cleansed and dry
- Wipes will last 18 months if tub is kept resealed
- No need for water
- Alcohol content 1-10%

Part No.	Qty	Description
VC530	1	Tub of 150 Wipes



SAS

S-A-S Non-Abrasive Hand Wipes

Heavy duty hand and skin wipes impregnated with an effective cleansing solution.

- Also suitable for cleaning tools
- Non-scratching
- Pleasant orange fragrance leaves hands smelling fresh and clean
- Alcohol content 1-10%

Part No.	Qty	Size
SAS520	1	Bucket of 150 Wipes



BIG WIPES 'Multi-Purpose' Super Tough Absorbent Wipes

Cleans paint (oil, water and hammer finish), adhesives (including adhesive and tape deposits), silicone, epoxy, PU foam, oil grease from hands, tools and surfaces.

- Alcohol content 0.1-1.0%

Part No.	Qty	Size
VC2010	1	80 Wipe Tub



BIG WIPES 'The Cage' Wall Bracket

Ideal for storing BIG WIPES on a van or in a workshop. Suits Part No.'s VC2010, VC2020 and VC2440.

Part No.	Qty	Size
VC2421	1	Wall Bracket



BIG WIPES 'Heavy-Duty' Textured, Scrub & Clean Wipes

Dual sided wipes designed for scrubbing and cleaning. Cleans paint, adhesive, oil and more from hands, tools & surfaces.

- Alcohol content 0.1-1.0%

Part No.	Qty	Size
VC2020	1	80 Wipe Tub



BIG WIPES 'Multi-Surface' Super Absorbent Bio Wipes

The biodegradable alternative for water based products and general dirt. Dermatologically tested and assessed to the latest EU regulations 1223/2009 - ZERO levels of skin irritation recorded. Unique formula cleans paint (oil, water and hammer finish), adhesives (including adhesive and tape deposits), silicone, epoxy, PU foam, oil grease from hands, tools and surfaces.

- All natural plant-based viscose fabric and unique 4X4 formula are 100% biodegradable
- Water-based formula offers >99% antibacterial protection
- Alcohol content 0.1-1.0%

Part No.	Qty	Size
VC2440	1	80 Wipe Tub

BIO
DEGRADABLE



ULTRA GRIME**BEST SELLER**

ULTRAGRIME PRO 'Multiuse' Clothwipes

Super-size performance alcohol-free low foaming wipes for hands, tools walls and all surfaces.

- Removes oil, grease, ink, paint, silicone and uncured PU foam
- 100 super-size wipes
- Stay wet for over an hour!
- Skin safe! - Dermatologically tested
- Super-soft, strong and absorbent
- Contains Vitamin E and Aloe extract
- Contains antibacterial agent

Part No.	Qty	Pack Size	Wipe Size
VC121	1	Pack of 100	38 cm x 25 cm

ULTRA GRIME**NEW****BIO DEGRADABLE**

ULTRAGRIME PRO 'Multiuse BIO' Biodegradable Clothwipes

Super-size performance alcohol-free low foaming wipes for hands, tools, walls and all surfaces. 100% biodegradable to EN14046.

- Removes oil, grease, ink, paint, silicone and uncured PU foam
- 100 super-size wipes
- Stay wet for over an hour!
- Skin Safe! - Dermatologically tested
- Super-soft, strong and absorbent
- Contains Vitamin E and Aloe extract
- Contains antibacterial agent

Part No.	Qty	Pack Size	Wipe Size
VC124	1	Pack of 100	38 cm x 25 cm

ULTRA GRIME**NEW****BACTERICIDAL VIRUCIDAL**

ULTRAGRIME PRO 'Anti-Bac' Clothwipes

Conforms to EN 1276, EN 13727 and EN 14476 standards. Bactericidal and virucidal wipe with a 60 second kill rate on viruses. Kills enveloped viruses including Coronaviruses and SARS Cov-2 which is the virus which causes Covid-19.

- 100 super-size wipes
- Kills 99.999% of germs in 30 seconds
- Stay wet for over an hour!
- Can be used on any surface
- Dermatologically tested - safe on hands

Part No.	Qty	Pack Size	Wipe Size
VC126	1	Pack of 100	38 cm x 25 cm

ULTRA GRIME**NEW****LIFTS · CLEANS · PROTECTS**

ULTRAGRIME PRO 'Power Scrub' Clothwipes

Ultra-strong cloth fabric has a rough abrasive side and a powerful grease-busting cleaning agent.

- 80 super-size wipes
- Dermatologically tested - safe on skin
- Stays wet and useable for over an hour
- Removes grease, paint, silicone, uncured PU foam, and adhesives
- Alcohol-free with vitamin E and aloe extract formula
- Safe for all surfaces
- Large absorbency capacity
- 3-in-1 action: lifts, cleans and protects

Part No.	Qty	Pack Size	Wipe Size
VC127	1	Pack of 80	38 cm x 25 cm



GRIMEX Alcohol Free Hand Cleaning Wipes

Individual hand cleaners. No mess, no waste, no water necessary. Cleans hands of: Oil, Grease, Ground in dirt, Inks, Paints and Tars where no water is available. Re-sealable dispenser pack.

Part No.	Qty	Description
VC519	1	Dispenser Pack of 100

uniwipe

**ANTIBACTERIAL FORMULA**

UNIWIPE 'Clinical' Sanitiser & Cleaner Wipes

Fragrance & alcohol-free clinical sanitiser and cleaner. Sanitising efficacy EN1276 and EN13727. Highly effective cleaning wipes with outstanding microbicidal performance. Effective against bacteria, fungi and viruses.

- Kills Norovirus, MRSA and H1N1
- Safe and suitable for all surfaces
- Grippy and absorbent
- Harmless and hand safe
- Trusted in healthcare organisations
- Dual action cleaner and sanitiser
- Very low foaming

Part No.	Qty	Pack Size	Wipe Size
VC122	1	Pack of 100	38 cm x 25 cm
VC125	1	Pack of 200	20 cm x 20 cm

Hand Wipes





NILCO 'H1' Professional Antibacterial Cleaner and Sanitiser

NSF Registration Number 141336. Complies with BS EN 1276. A neutral solvent based aqueous bactericidal and virucidal anti-static cleaner.

- Effective against a wide range of bacteria and moulds
- Leaves surfaces hygienically clean
- Fast drying, ideal for kitchen surfaces
- Safe for use on: Food preparation areas, work surfaces, stainless steel, ceramic tiles, walls and other hard non-porous surfaces



Part No.	Qty	Pack Size
NIL11	1	1 Litre Trigger Sprayer
NIL15	1	5 Litre Container



CLINELL Alcohol Free Universal Sanitising Wipes

Tested to European Standard EN1276 and prEN 12054. Proven to kill 99.999% of germs making them one of the most effective sanitising wipes on the market. Supplied in a durable resealable pack.

- Clinically proven to kill superbugs - NHS approved
- Wipes for cleaning and disinfecting surfaces and equipment
- No damage to surfaces

Part No.	Qty	Size
WS140	1	40 Wipes Pack
WS120	1	200 Wipes Pack

JEYES FLUID Multi-Purpose Disinfectant for Outdoor Use

Strong disinfectant for drains, dustbins, etc.

- Removes fungi, algae, moss and lichen from paths, fences, walls etc.



Part No.	Qty	Size
JEYS	1	5 Litres

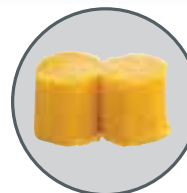

NILCO Citrus Urinal Blocks

Deodorant urinal blocks with a powerful, persistent perfume.



Part No.	Qty	Size
NIL618	1	3 kg Tub



NILCO Bactericidal Washing Up Liquid

Dilute 1:80 with water to ensure effective cleaning.

- Contains a broad spectrum biocide



Part No.	Qty	Size
NIL630	1	5 Litre Container

SAS

S-A-S Heavy Duty Surface Degreaser

Suitable for use in power wash and hand pump wash dispensers. Can also be used for hand application.

- Suitable for use on engines and chassis.
- Water-based and non-flammable
- Suitable for petrol station forecourts.
- Economical formula - can be diluted
- Silicone FREE formula.



Part No.	Qty	Size
SAS1059	1	5 Litre Container



NILCO Heavy Duty Floor Cleaner

Dilute with water for required performance.

- Citrus fragranced



Part No.	Qty	Size
NIL624	1	5 Litre Container

SAS

S-A-S Citrus Fragrance All Purpose Cleaner

Supplied in a stackable UN container. Soiling dilution ratio: Very heavy use neat, Heavy 10:1, Medium 50:1, Light 100:1.

- Non Harmful Formulation - Safe to use on virtually any substrate, cleans all hard surfaces including floors, walls, desks & washrooms
- Alloy Wheel Safe Formula - Perfect for cleaning vehicles inside and out, including highly polished and anodized aluminium alloy wheels
- Alcohol FREE formula



Part No.	Qty	Size
SAS2010	1	5 Litre Container

Antiviral Disinfectant

This powerful formulation kills a range of pathogenic viruses in under 5 minutes and is suitable for use on most non-porous surfaces. When used as directed, leaves treated surfaces safe for human contact.

- Effective against Coronavirus
- Kills 99.99% of germs and viruses
- Cleans and disinfects
- Ready to use

Part No.	Qty	Pack Size
VC508	1	750 ml Trigger Spray
VC509	1	5 Litre Container



LIFT Spray Cleaner with Bactericide

A liquid cleaner with a powerful bactericide which provides quick, easy cleaning and sanitising for all food preparation surfaces, microwaves, chopping boards, fridges and freezers.

- An effective hard surface cleaner and sanitiser capable of removing a wide variety of ingrained and greasy soiling
- Anti-microbial activity: effective against both gram negative and gram positive bacteria
- Tested under BSEN1276 and BSEN13697 and found to kill 99.99% of germs within 30 seconds

Part No.	Qty	Pack Size
VC511	1	750 ml Trigger Spray
VC512	1	5 Litre Container



Paper Towels

Paper towels help prevent cross contamination through minimal contact.

- Made from 100% recycled paper
- Wall Dispensers also available

Part No.	Pack Qty	Size W x L	Colour	Type
WB41	250	240 x 235 mm	Blue	Z-Fold
WB42	240	240 x 235 mm	Blue	V-Fold
WB43	240	230 x 310 mm	Green	C-Fold
WB40	1	Dispenser Unit		



Nail Brushes

Part No.	Pack of	Description
WS29	6	Plastic Nail Brushes
WS21	3	Wooden Nail Brushes



Toilet Rolls

2-ply sheets. Standard size.

Part No.	Pack of	Description
VC524	36 Rolls	Toilet Rolls



Blue Paper Wipes - Small Rolls

190 mm 2-ply sheets. 150 m rolls. Rolls can be centre fed for use with Dispenser Unit.

Part No.	Pack of	Description
VC529	6 Rolls	Small Blue Rolls
VC559	1	Dispenser Unit



Blue Paper Wipes - Large Rolls

280 mm 2-ply sheets. 400 m roll.

Part No.	Pack of	Description
VC537	2 Rolls	Large Blue Rolls
VC526	1	Floor Stand



White Paper Wipes - Low-Lint Airlaid

240 mm x 130 m rolls.

Part No.	Qty	Description
VC538	2 Rolls	White Paper
VC526	1	Floor Stand





Polishing (Mutton) Cloths

100% cotton stockinette.

Part No.	Qty	Size
WC1	1	750g Roll
WC3	1	1 kg Bale of Cut Lengths
WC13	1	2 kg Bale of Precut Lengths

Basic Coloured Industrial Wipes

Durable and re-useable mixture of cotton-rich material, ideal for heavy industrial cleaning where a cost-effective solution is required. NOT recommended for polishing.



Part No.	Qty	Size
VC667	1	10 kg Bag

General Purpose Industrial Wipes

Absorbent, durable and re-useable 'Rags-in-a-Bag'.



BEST SELLER

Part No.	Qty	Size
VC669	1	10 kg Bag

Standard White Industrial Wipes

Absorbent, durable and re-useable mixture of cotton-rich material 'Rags-in-a-Bag'.



BEST SELLER

Part No.	Qty	Size
VC668	1	10 kg Bag

Dustbin & Lid

Galvanised steel.

Part No.	Qty	Capacity
WB73	1	90 Litres

NEW



50L Swing Bin

Made from tough easy to clean polypropylene. Lift off lid for easy cleaning. Can be used with or without refuse sacks.

Part No.	Qty	Capacity
WB113	1	50 Litres

NEW



Bin Bags

White.

Part No.	Pack Qty	Size
WB71	1,000	380 x 600 x 600 mm

NEW

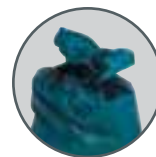

Polythene Sacks

For storage or refuse.

Part No.	Pack of	Dimensions
BAG14	50	89 x 56 cm (35" x 22")



Refuse Sacks/Liners

For general refuse.

Part No.	Pack of	Description
BAG17	100	Refuse Sacks/Liners

BEST SELLER





Stales (Broom Handles)
- 1 1/8" (28.7 mm) Ø

Suitable for Part Nos WB5, WB9 & WB12.

Part No.	Pack of	Length	
WB7L	2	5 ft Stales (Handles)	(1.52 m)



Stales (Broom Handles)
- 15/16" (23.8 mm) Ø

Suitable for Part Nos WB3, WB4, WB11 & WB81.

Part No.	Pack of	Length	
WB6	2	4 ft Stales (Handles)	(1.22 m)
WB6L	2	5 ft Stales (Handles)	(1.52 m)



Yard Broom Heads - Stiff Bass

For use with 15/16" Ø handle.

Part No.	Pack of	Width	Suits Stale Part No.
WB4	2	12" (30 cm)	WB6/WB6L



Broom Heads
- Soft Natural Coco

Part No.	Pack of	Width		Suits Stale Part No.
WB3	4	12" (30 cm)		WB6/WB6L
WB9	2	18" (46 cm)		WB7L
WB5	2	24" (61 cm)		WB7L



Metal Stays for Brooms

Suitable for Part No.s WB4, WB5 & WB9.

Part No.	Pack of	Description
WB8	2	Metal Stays



Broom Head
- Soft PVC Bristles

For use with 15/16" Ø handle.

Part No.	Qty	Width	Hole Size	Suits Stale Part No.
WB75	1	275 mm (11")	15/16"	WB6/WB6L



Hand Brushes
- Medium Bristles

Part No.	Pack of	Description
WB14	2	Hand Brushes



Dust Pan - Metal

Part No.	Qty	Description
WB15	1	Metal Dust Pan



Dustpan & Brush

Plastic.
• Soft nylon bristles

Part No.	Qty	Description
WB72	2 Piece Set	Dustpan & Brush



Looking for Mops & Buckets?

Our floor cleaning range continues overleaf



Stales (Broom Handles) - 15/16" (23.8 mm) Ø

Suitable for Part Nos WB3, WB4, WB11 & WB81.

Part No.	Pack of	Length	
WB6	2	4 ft Stales (Handles)	(1.22 m)
WB6L	2	5 ft Stales (Handles)	(1.52 m)

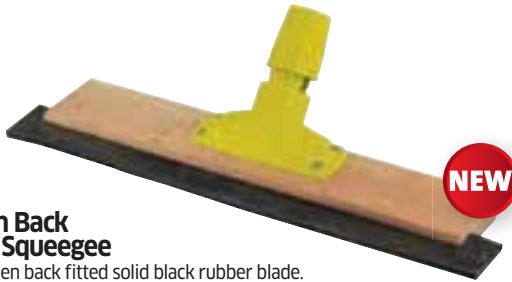

NEW

Wooden Back Rubber Squeegee

Plain wooden back fitted solid black rubber blade. Complete with the Rapid Lock System. For use with 15/16" Ø handle.

Part No.	Qty	Length	Suits Stale Part No.
WB11	1	457 mm	WB6/WB6L

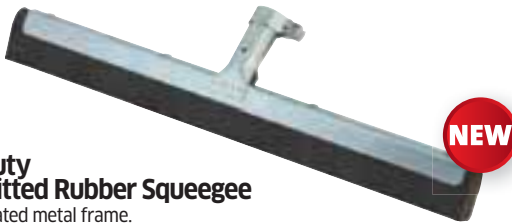

NEW

Light Duty Metal Fitted Rubber Squeegee

Chrome plated metal frame. Fitted 100% double mousse blade. For use with 15/16" Ø handle.

Part No.	Qty	Length	Suits Stale Part No.
WB12	1	450 mm	WB6/WB6L



Mop Head - String 16 oz

For use with 15/16" Ø handle.

Part No.	Qty	Description	Suits Stale Part No.
WB81	1	Mop Head	WB6/WB6L



Mop Bucket - Metal

Galvanised. Complete with wringing cone.

Part No.	Qty	Description
JUG11	1	Mop Bucket



NEW

Kentucky Mop System

Durable mop head suitable for wood, laminate and other floor surfaces.

Part No.	Qty	Description
WB76	1	Aluminium Screw Fit Handle - 1.37m
WB77	1	Plastic Mop Screw Fitting
WB78	1	Kentucky Mop Head - 454g



NEW

14L Plastic Mop Bucket

Made from durable and robust plastic. Graduation marked. Complete with large wringer.

Part No.	Qty	Description
WB80	1	Mop Bucket



NEW

20L Kentucky Mop Bucket On Wheels

Mop bucket with wringer. On wheels for easy manoeuvrability.

Part No.	Qty	Description
WB79	1	Mop Bucket On Wheels



NEW

Caution Wet Floor Sign

A-frame style foldable "Caution Wet Floor/Cleaning In Progress" sign.

Part No.	Qty	Description
WB112	1	Wet Floor Sign





Dry Vacuum Kit - 32 mm

Suits Numatic Henry type vacuums.

Part No.	Qty	Diameter
VAC11	1	32 mm

Kit contains: 1 x Pedal Floor Tool (VAC9) , 2.5 m Hose Kit (VAC14), Chrome Bend (VAC16).
2 x Chrome Straights (VAC18).

Vacuum Straight

Part No.	Qty	Diameter x Length	Material
VAC18	1	32 mm x 500 mm	Chrome



Vacuum Bend

Part No.	Qty	Diameter	Material
VAC16	1	32 mm	Chrome



Vacuum Bags

Suits Numatic Henry type vacuums.

Part No.	Pack of	Description	Type
VAC71	10	1 Motor Type	1B
VAC70	10	1 Motor - HEPA-FLO	

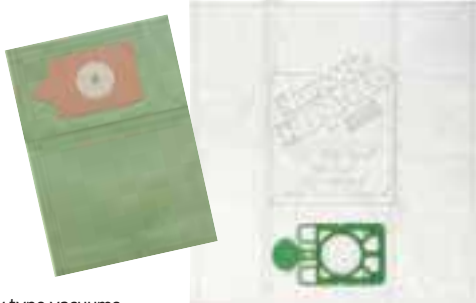

Vacuum Filters & Seals

Suits Numatic Henry type vacuums.

Part No.	Qty	Size
VAC50	1	12" Filter Dry
VAC51	1	12" Seal



Soft Round Dusting Brush

Brush diameter: 65 mm.

Part No.	Qty	Diameter
VAC2	1	32 mm



Crevice Tool

Tool length: 240 mm.

Part No.	Qty	Diameter
VAC4	1	32 mm



Upholstery Nozzle

Tool width: 150 mm.

Part No.	Qty	Diameter
VAC8	1	32 mm



Pedal Floor Tool

Tool width: 400 mm.

Part No.	Qty	Diameter
VAC9	1	32 mm



Angled Hose Cuff

Part No.	Qty	Diameter
VAC6	3 Piece Set	32 mm



Machine End Cuff

Part No.	Qty	Diameter
VAC20	2 Piece Set	32 mm



Hose Kit

Complete with Angled Hose Cuffs and Machine Cuffs

Part No.	Qty	Diameter x Hose Length
VAC14	1	32 mm x 2.5 m



Extra Long Hose

Part No.	Qty	Diameter x Hose Length
VAC13	1	32 mm x 15 m





Industrial Dry Vacuum Kit - 38 mm

Suits 2 and 3 motor vacuums.

Part No.	Qty	Diameter
VAC12	1 Kit	38 mm

Kit contains: 1 x All Brush Floor Tool (VAC23), 2.5 m Hose Kit (VAC15), Aluminium Bend (VAC17), 2 x Aluminium Straights (VAC19).



Commercial Wet Vacuum Kit

Suits 2 and 3 motor vacuums.

Part No.	Qty	Diameter
VAC32	1 Kit	38 mm

Kit contains: 1 x Wet Squeegee Floor Tool (VAC30), 2.5 m Hose Kit (VAC15), Aluminium Bend (VAC17), 2 x Aluminium Straights (VAC19).



Round Dusting Brush



Part No.	Qty	Diameter
VAC3	1	38 mm

Crevice Tool



Part No.	Qty	Diameter
VAC5	1	38 mm

All Brush Floor Tool

Tool width: 400 mm.



Part No.	Qty	Diameter
VAC23	1	38 mm

Wet & Dry Dual Floor Tool

Tool width: 400 mm. Brush front with rear squeegee.



Part No.	Qty	Diameter
VAC24	1	38 mm

Wet Squeegee Floor Tool

Tool width: 400 mm.



Part No.	Qty	Diameter
VAC30	1	38 mm

Angled Hose Cuff



Part No.	Qty	Diameter
VAC7	3 Piece Set	38 mm

Machine End Cuff



Part No.	Qty	Diameter
VAC21	2 Piece Set	38 mm

Hose Kit

Complete with Angled Hose Cuffs and Machine Cuffs



Part No.	Qty	Diameter x Hose Length
VAC15	1	38 mm x 2.5 m

Vacuum Straight



Part No.	Qty	Diameter x Length	Material
VAC19	1	38 mm x 500 mm	Aluminium

Vacuum Bend



Part No.	Qty	Diameter	Material
VAC17	1	38 mm	Aluminium



Commercial Wet & Dry Dual Floor Tool Vacuum Kit

Brush front with rear squeegee. Suits 2 and 3 motor vacuums.

Part No.	Qty	Diameter
VAC34	1 Kit	38 mm

Kit contains: 1 x Wet & Dry Multi-Tool (VAC24), 2.5 m Hose Kit (VAC15), Aluminium Bend (VAC17), 2 x Aluminium Straights (VAC19).



Commercial Wet & Dry Vacuum Kit

Suits 2 and 3 motor vacuums.

Part No.	Qty	Diameter
VAC33	1 Kit	38 mm

Kit contains: 1 x Wet Squeegee Floor Tool (VAC30), All Brush Floor Tool (VAC23), 2.5 m Hose Kit (VAC15), Aluminium Bend (VAC17), 2 x Aluminium Straights (VAC19)



Vacuum Bags

For 2 and 3 motor vacuums.

Part No.	Pack of	Description	Type
VAC72	10	2 Motor Type	3B
VAC73	10	3 Motor Type	4B

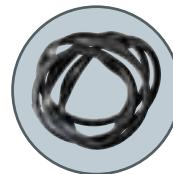

Vacuum Filters & Seals

Suits 2 and 3 motor vacuums.

Part No.	Qty	Size
VAC52	1	14" Filter Dry
VAC53	1	14" Seal



Heater & Vacuum On/Off Switches

16(4)A, 250VAC. Panel cut out 'A' style: 27.2 x 22.3 mm.

Part No.	Qty	Switch Colour
EC13	1	Black
EC14	1	Illuminated Red



Wet Ball Float Assembly

Suits 2 and 3 motor vacuums.

Part No.	Qty	Description
VAC42	1	Wet Ball Float Assembly



Vacuum Castors

Suits 2 and 3 motor vacuums.

Part No.	Pack of	Description	Fitting
VAC62	1	3" Swivel	Female
VAC64	1	3" Braked	Female
VAC63	4	3" Swivel	Male





Push & Twist Fit Wet & Dry Dual Floor Tool Vacuum Kit
Suits KÄRCHER NT type vacuums.

Part No.	Qty	Size
VAC100	1 Kit	38 mm

38 mm Kit contains: 1 x Wet & Dry Multi Tool, 2.5 m Hose Kit, Crevice Tool, Aluminium Bend, 2 x Aluminium Straights x 500 mm.



Cassette Hose Reel
15 m non-kink hose with fitted tap connector and spray nozzle. Supplied on an easy wind storage cassette.

Part No.	Qty	Description
TUB60	1	Cassette Hose Reel



Pails (Buckets)
Black heavy duty polythene. Graduated with pouring lip and handle.

Part No.	Pack of	Capacity
JUG8	5	14 Litre (3 Gallon)



Multi-Purpose Drain Pan
Polyethylene with raised platform for cleaning parts, etc. Diameter x Height: 40 cm (16") x 10.2 cm (4").

Part No.	Qty	Capacity
JUG12	1	6 Litre



Oil/Fluid Drain Pans
Complete with pouring spout and steadying handle.

Part No.	Qty	Capacity
JUG16	1	7.6 Litre
JUG17	1	14 Litre



Watering Can
Polythene.

Part No.	Qty	Capacity
JUG6	1	6.5 Litre



Watering Can
Polythene.

Part No.	Qty	Capacity
JUG10	1	10 Litre



Fuel Cans

Plastic. Conforms to the Petroleum-spirit (plastic Containers) Regulations 1982 SI1982/630.

- Colour coded for safe identification of fuels.
- c/w easy to use flexible pouring spouts.

Part No.	Qty	Capacity	Colour	Suits
CAN105	1	5 Litre	Green	Petrol
CAN110	1	10 Litre	Black	Diesel



Steel Jerry Can

Conforms with UN Certification and UK HSE regulations. Manufactured from 0.8 mm steel. Safety pin included.

- Robust construction for strength and long lasting performance
- Powder coated internally and external for a tough and durable finish

Part No.	Qty	Capacity	Colour	Size (H x D x W)
CAN305	1	5 Litre	Khaki Green	24 x 12 x 31 cm
CAN310	1	10 Litre	Khaki Green	30 x 13 x 41 cm
CAN320	1	20 Litre	Khaki Green	36 x 17 x 47 cm



Steel Jerry Can Spout

Manufactured from 0.8 mm steel. Designed to fit snugly onto the 5, 10 and 20 Litre Jerry Cans.

- Powder coated internally and external for a tough and durable finish
- Makes pouring easier

Part No.	Qty	Description
CAN24	1	Pouring Spout



S-A-S 5 Litre Dispenser Tap

Suits all S-A-S 5 Litre UN containers.

Part No.	Qty	Thread Size
SAS2000T	1	51 mm



Drum Tap

Manufactured from PE, PP and LDPE. Suitable for use with blow moulded containers with DIN 60 neck finish (HDPE/PP).

Part No.	Qty	Thread Size	Suits Part No.
SAS62T	1	61 mm	SAS62



Die Cast Zinc Drum Tap - Lockable

NOT suitable for diesel.

Part No.	Qty	Thread Size
CAN21	1	3/4" BSP



Drum Tap - Polyethylene

Part No.	Pack of	Thread Size
VC99	3	3/4" BSP



Drum Tap - Polypropylene

Lockable. Suitable for diesel and anti-freeze.

Part No.	Qty	Thread Size
CAN22	1	3/4" BSP



Drum Tap - Solid Brass

Lockable.

Part No.	Qty	Description
CAN23	1	3/4" BSP



Drum Tap - Self Closing All Metal

Zinc alloy. Lockable.

Part No.	Qty	Thread Size
CAN20	1	3/4" BSP





Oil Suction Guns

Supplied with 400 mm hose.

Part No.	Qty	Capacity
CAN16	1	500 cc
CAN11	1	800 cc
CAN18	1	1000 cc

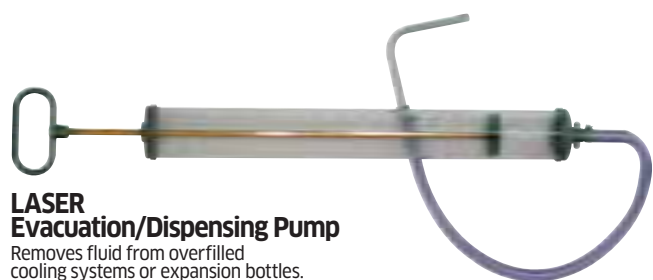

LASER Evacuation/Dispensing Pump

Removes fluid from overfilled cooling systems or expansion bottles.

- Metric and imperial measures.
- Polycarbonate tube with aluminium cap and handle.

Part No.	Qty	Capacity
TL7400	1	1 Litre



Lever Operated Barrel Pump

Supplied with a 2" BSP and Tri-sure adaptor.

Includes telescopic riser tube and 2 metre hose.

Polypropylene body. Viton seals. 500cc flow rate (per stroke).

Size: 1 m x 260 mm. NOT suitable for products containing Toluene.

- Suitable for use with:
- AdBlue® Solution
 - Water based liquids
 - Solvents
 - Screenwash
 - Thinners
 - Antifreeze
 - Light oils

Part No.	Qty	Suitable for
CAN50	1	50 - 205 Litre Drums



Metal Oil Can

Seamless steel body with polythene pump and rigid metal spout.

Part No.	Qty	Capacity
CAN2	1	500ml



Hand Operated Oil Suction Pump

Supplied with 3 extension tubes. NOT suitable for Petrol or Diesel.

- Ideal for extracting* or changing engine oils or lubricants in plant, vehicles, motorbikes, etc. As well as non lubricants such as water from tanks.
- * Extracts fluids ONLY.

Part No.	Qty	Capacity
CAN30	1	6.5 Litres

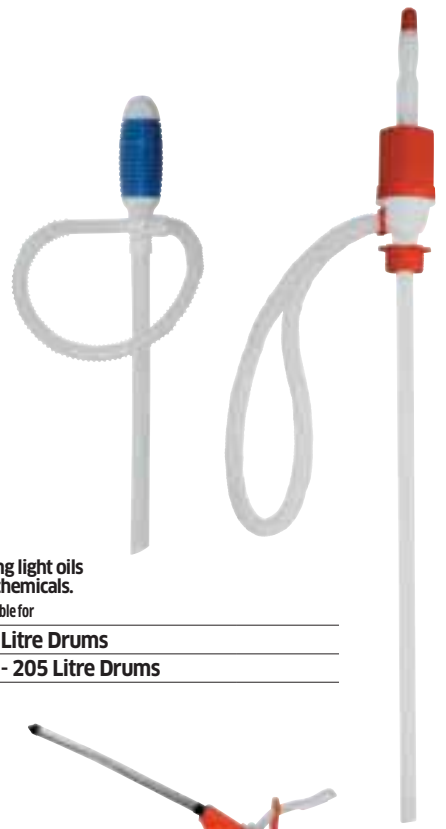

Syphon Pumps

Flexible hose. 2" BSP.

- Suitable for dispensing light oils and non-aggressive chemicals.

Part No.	Qty	Suitable for
CAN25	1	25 Litre Drums
CAN60	1	60 - 205 Litre Drums



Oil Can

Polypropylene body with flexible spout.

Part No.	Qty	Capacity
CAN1	1	500ml





ALTA Foam Pressure Sprayer

Contains FPM VITON® (FKM) seals. Special lance produces a rich foam to help dissolve/degrease dirt. Suitable for use with S-A-S Snow Foam (Part No. SAS2017).

- High foaming action spray

Part No.	Qty	Capacity
CAN27	1	1.8 Litre

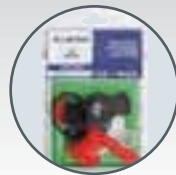

ALTA Detergent (TFR) Pressure Sprayer

Contains EPDM seals.

- Suitable for use with Glycol, Detergents (TFR), Mild Acids, Hydraulic Oils and Solvents containing Acetone.

Part No.	Qty	Capacity
CAN14	1	1.8 Litre
CAN14K	1 Kit	EPDM Seal/Repair Kit



ALTA Foam Pressure Sprayer

Contains FPM VITON® (FKM) seals. Supplied with 3 x interchangeable nozzles to adjust the foam thickness. Suitable for use with S-A-S Snow Foam (Part No. SAS2017).

- High foaming action spray
- Lance with 120 cm long hose

Part No.	Qty	Working Capacity
CAN28	1	6.0 Litre



ALTA Solvent Pressure Sprayer

Contains FPM VITON® (FKM) seals.

- Suitable for use with Oils, Lubricants, Petrol, Solvents and Scale-Removers.
- Can only be used with Acetone FREE Brake Cleaner.

Part No.	Qty	Capacity	Suits Part No.s
CAN19	1	1.3 Litre	
CAN13	1	1.8 Litre	
CAN13K	1 Kit	FPM VITON® Seal/Repair Kit	CAN13, CAN19

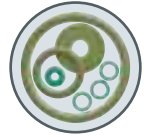

Solvent Pressure Sprayers

Polyamid pump with FKM seals. Polyethylene container.

Part No.	Qty	Capacity	Suits Part No.s
CAN12	1	1 Litre	
CAN15	1	1.5 Litre	
CAN12K	1 Kit	Replacement FKM Seal Kit	CAN12, CAN15



Solvent Sprayer

FKM seal.

Part No.	Qty	Capacity
CAN7	1	1 Litre



PRESSOL



BEST SELLER

PRESSOL Chemical Sprayers

Heavy duty polyethylene.

- Suitable for use with cleaning fluids, lubricants and penetrating agents.
- Fully adjustable nozzle allows operator to pre-set the spray.

Part No.	Qty	Capacity
CAN3A	1	750ml
CAN3	12	750ml

PRESSOL



PRESSOL Industrial Trigger Sprayer - 500 ml

Container: HDPE (high density polyethylene).

- INOX spring and pressure ball on filtered suction hose allows for unique horizontal application.
- Continuous spray action, spray volume per cycle: 1.4 ml.
- FKM seals - Suitable for use with thin liquids such as lubricants, **Acetone FREE** brake cleaner, industrial and automotive cleaners.

Part No.	Qty	Container Colour	Spray head Colour
CAN55	1	Black	Black/Silver
CAN56	1	Red	Black



ALTA '500' Leak-proof Solvent Sprayer

High-density polyethylene (HDPE) body is resistant to most solvents. Stainless steel springs and ball bearings.

- 100% airtight seal prevents leakage
- Leak-proof trigger
- Suitable for aggressive chemicals

Part No.	Qty	Capacity
CAN26	1	500ml



Heavy Duty Adjustable Trigger Sprayer

Polypropylene body. NOT suitable for use with Brake Cleaners.

- Fully adjustable nozzle
- Suitable for use with general chemicals (i.e. De-Icer, De-Greasers, Maintenance Oils)

Part No.	Qty	Capacity
CAN8	1	750ml



BEST SELLER



Measuring Jugs

Polythene with removable spout.

Part No.	Qty	Capacity
JUG21	1	1 Litre
JUG22	1	2 Litre
JUG23	1	5 Litre
JUG23A	1	Replacement Spout for 5 Litre Jug



Measuring Jugs

Complete with lid and removable spout with stopper.

Part No.	Qty	Capacity
JUG31	1	1 Litre
JUG32	1	2 Litre
JUG33	1	5 Litre



Funnel with Flexible Spout

Polyethylene with removable brass filter.

Part No.	Qty	Diameter	
FUN60	1	160 mm	(6.4")



Funnel with Cranked Spout

Polyethylene with removable brass filter.

Part No.	Qty	Diameter	
FUN50	1	162 mm	(6.4")



Funnel with Flexible Spout

Polythene with removable flexible spout and filter.

Part No.	Qty	Diameter	
FUN1	1	150 mm	(6")
FUN2	1	230 mm	(9")



Measuring Jug

Polythene.

Part No.	Qty	Capacity	
JUG3	1	5 Litre	

PRESSOL



PRESSOL Funnel with Flexible Spout

Polyethylene with removable brass filter.

Part No.	Qty	Diameter	
FUN6	1	160 mm	(6.4")

PRESSOL



PRESSOL Funnel with Cranked Spout

Polyethylene with removable brass filter.

Part No.	Qty	Diameter	
FUN5	1	162 mm	(6.4")

PRESSOL



PRESSOL Small Funnel Set

Polythene.

Part No.	Qty	Description	
FUN7	1 Set	5 Piece Set	

5 x Sizes: Ø 60, 80, 100, 120, 140 mm.

BEST SELLER



Rectangular Funnel

Polyethylene with stainless steel filter.

Part No.	Qty	Length	
FUN3	1	300 mm	(12")





BEST SELLER

General Purpose Absorbent Pads - Lightweight

Supplied in a dispenser box with carrying handle.

Part No.	Box of	Pad dimensions	Weight
VC670	50 Pads	48 x 43 cm	175 gsm



General Purpose Absorbent Pads - Lightweight

Supplied in a dispenser box with carrying handle.

Part No.	Box of	Pad Dimensions	Weight
VC670B	200 Pads	48 x 43 cm	175 gsm



General Purpose Absorbent Roll - Heavy Duty

Part No.	Qty	Size	Weight
VC672	1 Roll	50 cm x 50 m Roll	350 gsm

BEST SELLER



'OIL-DRI' Absorbent Floor Granules

Ideal for oil and grease. Good absorbency. Good resistance to breakdown. White granules.

Part No.	Qty	Size
VC679	1	20 Litre Bag



Hazard Warning Barrier Tape

70 mm x 500 m roll. NON-adhesive, highly visible.

Part No.	Qty	Colours
TAPE20	1 Roll	Black/Yellow
TAPE21	1 Roll	White/Red



General Purpose Maintenance Socks

For containment and absorbing spills, and placing around machinery to prevent leaks from spreading causing hazards. Absorbs: 3.5 Litres per sock.

Part No.	Pack of	Size
VC686	2	8 cm x 1.2 m



General Purpose 'Mini' Spill Kit - 9 Litres

Mini spill kit in convenient sealed bag. Absorbs: 9 Litres.

Part No.	Qty	Description
VC682	1 Kit	7 Piece Kit

Kit contents: 5 x Pads. 1 x Cushion. 1 x Disposal Bag & Tie.



General Purpose Spill Kit - 19 Litres

Quick response kit designed for smaller spills. Absorbs: 19 Litres. Weight: 2.5 kg.

Part No.	Qty	Description
VC680	1 Kit	13 Piece Kit

Kit contents: 10 x Pads. 2 x Socks: 8 cm x 1.2 m. 1 x Disposal Bag & Tie: (H x W x D) 43 x 52 x 10 cm.



'Isol8' Organic Absorbent

Multipurpose: cleans up spills, cleans hands and machinery. Absorbs: Lubrication Oil, Hydraulic Oil, All Paints, Petrol, Diesel, Grease, Anti-freeze, Acids, Alkalines, Liquid Fats, Water, Body Fluids.

- **Highly concentrated: Economical, fast acting and space-saving.**
- **Lightweight: safe to carry, easy to pour.**
- **Organic: environmentally friendly, 100% recycled natural material, can be incinerated.**

Part No.	Qty	Size	Weight
VC678	1 Bag	10 Litre Bag	1.3 kg
VC678B	5 Bags	10 Litre Bags	1.3 kg



Hazard Warning Adhesive Tapes

50 mm x 33 m roll. Highly visible. Suitable for use on concrete floors.

Part No.	Qty	Colours
TAPE24	1 Roll	Black/Yellow
TAPE25	1 Roll	White/Red

BEST SELLER



Oil & Fuel Only Absorbent Pads - Lightweight

Supplied in a dispenser box with carrying handle.

Part No.	Box of	Pad dimensions	Weight
VC671	50 Pads	50 x 40 cm	175 gsm



Oil & Fuel Only Absorbent Pads - Lightweight

Supplied in a dispenser box with carrying handle.

Part No.	Box of	Pad Dimensions	Weight
VC671B	200 Pads	50 x 40 cm	175 gsm



Oil & Fuel Only Absorbent Roll - Heavy Duty

Part No.	Qty	Size	Weight
VC673	1 Roll	50 cm x 50 m Roll	350 gsm



Caution Wet Floor Sign

A-frame style foldable "Caution Wet Floor/Cleaning In Progress" sign.

Part No.	Qty	Description
WB112	1	Wet Floor Sign



Looking for Drain Pans or Buckets?

Our liquid handling range is on Page 354



Oil & Fuel Only Maintenance Socks

Oil only socks, strong tubular knitted outer for extra durability. Absorbs: 3.8 Litres per sock.

Part No.	Pack of	Size
VC687	2	9 cm x 1.2 m

Oil & Fuel Only 'Mini' Spill Kit - 10 Litres

Mini spill kit in convenient sealed bag. Absorbs: 10 Litres.

Part No.	Qty	Description
VC683	1 Kit	7 Piece Kit

Kit contents: 5 x Oil Pads. 1 x Cushion. 1 x Disposal Bag & Tie.



Oil & Fuel Only Spill Kit - 22 Litres

Quick response kit designed for smaller spills. Suitable for any type of oil and hydrocarbons. Absorbs: 22 Litres.

Part No.	Qty	Description
VC681	1 Kit	13 Piece Kit

Kit contents: 10 x Oil Pads. 2 x Socks: 8 cm x 1.2 m. 1 x Disposal Bag & Tie: (H x W x D) 43 x 52 x 10 cm.



Oil & Fuel Only Spill Response Kit - 20 Litres

Response kit designed for smaller spills. Suitable for any type of oil and hydrocarbons. Absorbs: 20 Litres. Supplied in a red PVC holdall c/w carrying/hanging straps.

Part No.	Qty	Description
VC684	1 Kit	19 Piece Kit

Kit contents: 12 x Oil Pads. 2 x Oil Socks. 1 x Pair of Gloves 3 x Disposable Bags & Ties. 1 x Red PVC Holdall.

Oil Only Spill Response Kit - 50 Litres

Response kit designed for larger spills. Suitable for any type of oil and hydrocarbons. Absorbs: 50 Litres. Supplied in a red PVC holdall c/w carrying/hanging straps.

Part No.	Qty	Description
VC685	1 Kit	44 Piece Kit

Kit contents: 30 x Oil Pads. 3 x Oil Socks. 3 x Cushions. 1 x Pair of Gloves. 1 x Pair of Goggles. 5 x Disposable Bags & Ties. 1 x Red PVC Holdall.





Premier Burn Care Kit

Supplied in a robust polypropylene storage case.

- The red box makes it highly visible & easy to identify
- The kit provides effective and fast treatment for burns, scalds and sunburn

Part No.	Qty	Description
WS170	1 Kit	23 Piece Kit

Contents: 1 x Burnshield burn dressings 20cm x 20cm 2 x Burnshield burn dressings 10cm x 10cm
 8 x Burnshield blott sachets 5 x Sterowash 20ml eyewash pods 1 x Crepe bandage - 10cm x 5m
 2 x Conforming bandage - 7.5cm x 4m 2 x Vinyl gloves (pair) 1 x Microporous tape 2.5cm x 5m 1 x Scissors (pair)



RING Fire Extinguishers

Complete with secure mounting bracket. ABC rating for solid, liquid, gas and electrical fires. Weight: 1 kg.

- Ideal for all automotive, domestic and leisure use.

Part No.	Qty	Type
FE1	1	ABC Dry Powder
FE2	1	ABC Dry Powder with Gauge



Eyewash Station

For wall mounting. Complete with mirror. Contains 2 x 500ml bottles of sterile sodium chloride solution.

Part No.	Qty	Description
WS200	1 Kit	Eyewash Station
WS200R	1	Eyewash Solution 500ml Bottle



SLEEPSAFE Smoke Alarm

Certified to EN 14604:2005. Photoelectric technology, helps to reduce nuisance alarms.

- Complete with 9V battery
- No mains power required
- Easy to install
- Reliable, compact and robust
- Powerful 85 dB speaker

Part No.	Qty	Description
DET6	1	Smoke Alarm



SLEEPSAFE CO Alarm

Certified to EN 50291:2001. Features 3 visual LED readouts: Alarm, Sensor and Power

- Complete with 9V battery
- No mains power required
- Reliable, compact and robust
- Easy to install
- 6 year guarantee
- Powerful 85 dB speaker

Part No.	Qty	Description
DET5	1	CO Alarm



SLEEPSAFE 10 Year CO Alarm

Certified to EN50291-1:2010 and EN50291-2:2010. Features 3 visual LED readouts: Alarm, Fault and Power

- Complete with 10 Year sealed-for-life battery
- No mains power required
- Reliable, compact and robust
- Easy to install
- Powerful 85 dB audible alarm

Part No.	Qty	Description
DET7	1	CO Alarm



SLEEPSAFE CO Detectors

Coloured dot will change colour in the presence of excess Carbon Monoxide. A small and convenient simple CO detector, ideal for testing heating equipment at work, home or away. 4 month life span once opened. Supplied in a blister pack.

Part No.	Pack of	Description
DET1	2	CO Detectors



Single Use Eye/Wound Wash Pods

Part No.	Box of	Size
WS78	25	25 ml Bottles



Size: 240 x 360 mm



Part No.	Qty	Type
SSB130	1	Sign
SSA131	1	Sticker



Part No.	Qty	Type
SSB132	1	Sign
SSA133	1	Sticker



Part No.	Qty	Type
SSB134	1	Sign
SSA135	1	Sticker



Part No.	Qty	Type
SSB136	1	Sign
SSA137	1	Sticker



Part No.	Qty	Type
SSB122	1	Sign
SSA123	1	Sticker



Part No.	Qty	Type
SSB124	1	Sign
SSA125	1	Sticker



Part No.	Qty	Type
SSB126	1	Sign
SSA127	1	Sticker



Part No.	Qty	Type
SSB128	1	Sign
SSA129	1	Sticker

Size: 360 x 120 mm

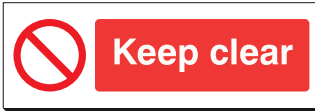

Part No.	Qty	Type
SSB114	1	Sign
SSA115	1	Sticker



Part No.	Qty	Type
SSB106	1	Sign
SSA107	1	Sticker



Part No.	Qty	Type
SSB104	1	Sign
SSA105	1	Sticker



Part No.	Qty	Type
SSB102	1	Sign
SSA103	1	Sticker



Part No.	Qty	Type
SSB112	1	Sign
SSA113	1	Sticker



Part No.	Qty	Type
SSB110	1	Sign
SSA111	1	Sticker



Part No.	Qty	Type
SSB108	1	Sign
SSA109	1	Sticker



Part No.	Qty	Type
SSB116	1	Sign
SSA117	1	Sticker



Part No.	Qty	Type
SSB120	1	Sign
SSA121	1	Sticker

Size: 350 x 480 mm



Part No.	Qty	Type
SSB142	1	Sign



Part No.	Qty	Type
SSB139	1	Sign

Size: 480 x 350 mm



Part No.	Qty	Type
SSB118	1	Sign
SSA119	1	Sticker



Part No.	Qty	Type
SSB143	1	Sign



Part No.	Qty	Type
SSB141	1	Sign



Part No.	Qty	Type
SSB140	1	Sign

Traffic & Prohibitory Signs

These signs are used to warn people of a potential hazard.

Designed to be used in a wide variety of situations, in factories, building sites, farms, estates and warehouses, they can be displayed inside or outside and are fully waterproof.

Traffic signs are ideal for use on private traffic routes, car parks and industrial estates.

Prohibitory signs or "No" signs are generally depicted with a black safety symbol in a red circle with a diagonal cross through.

Signs are manufactured from high quality 3 mm foamex board.

Self adhesive vinyl stickers are fully waterproof conforming to BS ISO EN 7010.



Size: 80 x 80 mm



Part No.	Qty	Type
SSA101	10	Stickers



Part No.	Qty	Type
SSB138	1	Sign

Size: 100 x 250 mm



CO²

Part No.	Qty	Type
SSA258	1	Sticker



Water

Part No.	Qty	Type
SSA261	1	Sticker



Size: 120 x 120 mm



Part No.	Qty	Type
SSA254	1	Sticker

Part No.	Qty	Type
SSA255	1	Sticker



Dry Powder

Part No.	Qty	Type
SSA260	1	Sticker



Foam Spray

Part No.	Qty	Type
SSA259	1	Sticker



Part No.	Qty	Type
SSA256	1	Sticker

Part No.	Qty	Type
SSA257	1	Sticker



Size: 360 x 120 mm



Part No.	Qty	Type
SSB270	1	Sign
SSA271	1	Sticker

Part No.	Qty	Type
SSB272	1	Sign
SSA273	1	Sticker

Fire Safety Signs

Fire Extinguisher Stickers are used to indicate the type of fire extinguisher present, and for what types of fire it can be used.

Mandatory Fire Stickers, such as "Fire door keep closed", are used on fire doors and fire escape doors and must be kept clear on both sides for ease of evacuation.

Signs are manufactured from high quality 3 mm foamex board.

Self adhesive vinyl stickers are fully waterproof conforming to BS ISO EN 7010.



Size: 360 x 120 mm



Part No.	Qty	Type
SSB266	1	Sign
SSA267	1	Sticker



Part No.	Qty	Type
SSA276	1	Sticker



Part No.	Qty	Type
SSB264	1	Sign
SSA265	1	Sticker



Part No.	Qty	Type
SSB268	1	Sign
SSA269	1	Sticker



Part No.	Qty	Type
SSA277	1	Sticker



Part No.	Qty	Type
SSB262	1	Sign
SSA263	1	Sticker



Part No.	Qty	Type
SSA275	1	Sticker



Part No.	Qty	Type
SSA274	1	Sticker



Part No.	Qty	Type
SSA278	1	Sticker

Size: 240 x 360 mm

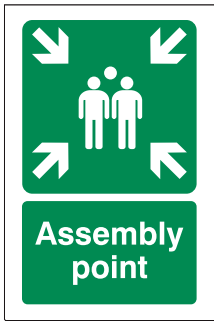

Part No.	Qty	Type
SSB279	1	Sign
SSA280	1	Sticker



Part No.	Qty	Type
SSB285	1	Sign
SSA286	1	Sticker



Part No.	Qty	Type
SSB281	1	Sign
SSA282	1	Sticker

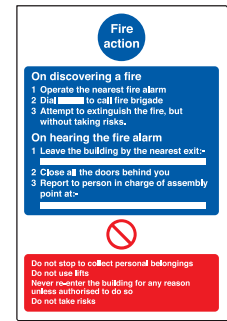

Part No.	Qty	Type
SSB283	1	Sign
SSA284	1	Sticker

Fire Exit & Emergency Signs

Fire Exit Signs are used to tell people where to go in the event of a fire. An essential sign for use on all commercial premises.

You should always be able to see a "Fire Exit" sign indicating the direction you should take.

Signs are manufactured from high quality 3 mm foamex board.

Self adhesive vinyl stickers are fully waterproof conforming to BS ISO EN 7010.



Size: 100 x 100 mm



Part No.	Qty	Type
SSA239	1	Sticker



Part No.	Qty	Type
SSA240	1	Sticker



Part No.	Qty	Type
SSA241	1	Sticker



Part No.	Qty	Type
SSA242	1	Sticker



Part No.	Qty	Type
SSA243	1	Sticker



Part No.	Qty	Type
SSA244	1	Sticker



Part No.	Qty	Type
SSA245	1	Sticker



Part No.	Qty	Type
SSA246	1	Sticker

Size: 240 x 360 mm

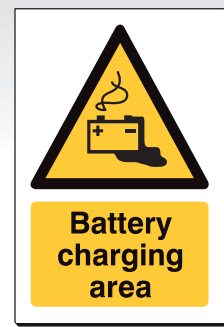

Part No.	Qty	Type
SSB227	1	Sign
SSA228	1	Sticker



Part No.	Qty	Type
SSB219	1	Sign
SSA220	1	Sticker



Part No.	Qty	Type
SSB203	1	Sign
SSA204	1	Sticker



Part No.	Qty	Type
SSB213	1	Sign
SSA214	1	Sticker



Part No.	Qty	Type
SSB205	1	Sign
SSA206	1	Sticker



Part No.	Qty	Type
SSB201	1	Sign
SSA202	1	Sticker

Transport Hazard Warning Labels

The ADR (European agreement concerning the international carriage of dangerous goods by road) regulations, state that all packages containing dangerous goods should have a warning label. The labels shall be in the form of a square at an angle of 45° (diamond shaped).

Used in the transportation of dangerous goods by road, sea and air. Our Hazard Warning Diamonds comply with International legislation.

Self adhesive vinyl stickers are fully waterproof conforming to BS ISO EN 7010.



Size: 360 x 120 mm



Part No.	Qty	Type
SSB319	1	Sign
SSA320	1	Sticker



Part No.	Qty	Type
SSB325	1	Sign
SSA326	1	Sticker



Part No.	Qty	Type
SSB317	1	Sign
SSA318	1	Sticker



Part No.	Qty	Type
SSB315	1	Sign
SSA316	1	Sticker



Part No.	Qty	Type
SSB323	1	Sign
SSA324	1	Sticker



Part No.	Qty	Type
SSB311	1	Sign
SSA312	1	Sticker



Part No.	Qty	Type
SSB321	1	Sign
SSA322	1	Sticker



Part No.	Qty	Type
SSB313	1	Sign
SSA314	1	Sticker

Size: 360 x 240 mm

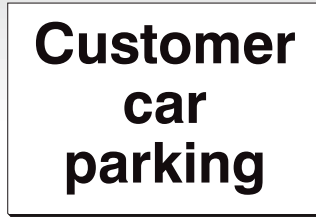

Part No.	Qty	Type
SSB307	1	Sign
SSA308	1	Sticker



Part No.	Qty	Type
SSB305	1	Sign
SSA306	1	Sticker



Part No.	Qty	Type
SSB301	1	Sign
SSA302	1	Sticker



Part No.	Qty	Type
SSB309	1	Sign
SSA310	1	Sticker



Part No.	Qty	Type
SSB303	1	Sign
SSA304	1	Sticker

General Signs

Use to advise staff and visitors of common site and warehouse locations and ensure procedures are followed.

Signs are manufactured from high quality 3 mm foamex board.

Self adhesive vinyl stickers are fully waterproof conforming to BS ISO EN 7010.





Part No.	Qty	Type	Material
SSB248	1	Sign	3 mm Foamex



Part No.	Qty	Type	Material
SSB253	1	Sign	3 mm Foamex



Part No.	Qty	Type	Material
SSB251	1	Sign	3 mm Foamex



Part No.	Qty	Type	Material
SSB249	1	Sign	3 mm Foamex



Part No.	Qty	Type	Material
SSB252	1	Sign	3 mm Foamex



Part No.	Qty	Type	Material
SSB143	1	Sign	3 mm Foamex



Part No.	Qty	Type	Material
SSB247	1	Sign	3 mm Foamex

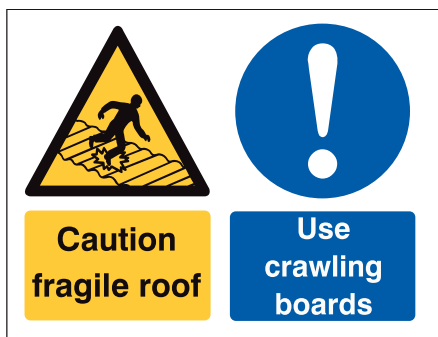

Part No.	Qty	Type	Material
SSB250	1	Sign	3 mm Foamex

Size: 360 x 350 mm



Part No.	Qty	Type	Material
SSB237	1	Sign	3 mm Foamex
SSA238	1	Sticker	Self Adhesive Vinyl

Multi-Message Signs

Used for areas and situations where more than one safety message is required, ideal for situations where wall space is limited.

Signs are manufactured from high quality 3 mm foamex board.

Self adhesive vinyl stickers are fully waterproof conforming to BS ISO EN 7010.



Size: 240 x 360 mm



Part No.	Qty	Type
SSB405	1	Sign
SSA406	1	Sticker



Part No.	Qty	Type
SSB411	1	Sign
SSA412	1	Sticker



Part No.	Qty	Type
SSB403	1	Sign
SSA404	1	Sticker



Part No.	Qty	Type
SSB407	1	Sign
SSA408	1	Sticker



Part No.	Qty	Type
SSB415	1	Sign
SSA416	1	Sticker



Part No.	Qty	Type
SSB409	1	Sign
SSA410	1	Sticker



Part No.	Qty	Type
SSB417	1	Sign
SSA418	1	Sticker



Part No.	Qty	Type
SSB419	1	Sign
SSA420	1	Sticker



Part No.	Qty	Type
SSB401	1	Sign
SSA402	1	Sticker



Part No.	Qty	Type
SSB421	1	Sign
SSA422	1	Sticker



Part No.	Qty	Type
SSB413	1	Sign
SSA414	1	Sticker



Part No.	Qty	Type
SSB423	1	Sign
SSA424	1	Sticker

Mandatory PPE Signs

Mandatory PPE Signs are used to warn people of potential damage to their health if they do not wear the correct PPE and encourages them to do so. Designed to be used in a wide variety of situations, in factories, building sites, farms, estates and warehouses, displayed inside or outside.

Signs are manufactured from high quality 3 mm foamex board.

Self adhesive vinyl stickers are fully waterproof conforming to BS ISO EN 7010.



Size: 480 x 300 mm



Part No.	Qty	Type	Material
SSB503	1	Sign	3 mm Foamex



Part No.	Qty	Type	Material
SSB502	1	Sign	3 mm Foamex

Size: 350 x 350 mm



Part No.	Qty	Type	Material
SSB501	1	Sign	3 mm Foamex

Size: 480 x 150 mm



Part No.	Qty	Type	Material
SSB506	1	Sign	3 mm Foamex



Part No.	Qty	Type	Material
SSB507	1	Sign	3 mm Foamex



Part No.	Qty	Type	Material
SSB505	1	Sign	3 mm Foamex



Part No.	Qty	Type	Material
SSB504	1	Sign	3 mm Foamex

M.o.T. Signs

M.o.T. Signs should be used at a vehicle testing station which is approved by the Department of Transport.

Clearly indicate an M.o.T. station, designated area or services available that will inform new and existing customers alike.

Signs are manufactured from high quality 3 mm foamex board are fully waterproof conforming to BS ISO EN 7010.





Blue Vinyl Nitrile Hybrid Gloves - Powder FREE

High quality PVC/Nitrile blend.

- Nitrile provides good strength, protection and a snug fit combined with the sensitivity of vinyl
- Synthetic materials ensures 100% latex FREE

Part No.	Qty	Size
VC842	Box of 100	S
VC882	10 x Boxes of 100	S
VC843	Box of 100	M
VC883	10 x Boxes of 100	M
VC844	Box of 100	L
VC884	10 x Boxes of 100	L
VC845	Box of 100	XL
VC885	10 x Boxes of 100	XL



GRIPPAZ Orange Grip Gloves

This glove is designed to cover a broad spectrum of industrial uses including automotive, assembly, paint spraying, cleaning, electro-plating asbestos removal and janitorial.

- Ambidextrous
- Ergonomic Grip
- CE Level 5 Dexterity
- Chemical Resistant



Part No.	Qty	Size
VC619	Box of 50	M
VC626	10 x Boxes of 50	M
VC620	Box of 50	L
VC627	10 x Boxes of 50	L
VC621	Box of 50	XL
VC628	10 x Boxes of 50	XL
VC622	Box of 50	XXL
VC629	10 x Boxes of 50	XXL



'Black Pearl' Soft Nitrile Gloves - Powder FREE

Complies to EN455.

High quality powder free nitrile AQL 1.5.

- Latex Free - Synthetic materials eliminates protein sensitisation
- Nitrile Formulation - Provides good resistance to tears and punctures
- Fingertip textured

Part No.	Qty	Size
VC563	Box of 100	M
VC594	10 x Boxes of 100	M
VC564	Box of 100	L
VC595	10 x Boxes of 100	L
VC565	Box of 100	XL
VC596	10 x Boxes of 100	XL



Blue Nitrile Gloves - Powder FREE

Part No.	Qty	Size
VC553	Box of 100	S
VC590	10 x Boxes of 100	S
VC554	Box of 100	M
VC591	10 x Boxes of 100	M
VC555	Box of 100	L
VC592	10 x Boxes of 100	L
VC556	Box of 100	XL
VC593	10 x Boxes of 100	XL



Orange HD Diamond Grip Nitrile Gloves - Powder Free

High quality powder free nitrile AQL 1.5.

- Unique diamond grip optimises surface performance and provides a high grip strength
- Good resistance to tears and punctures
- Latex Free - Synthetic materials eliminates protein sensitisation

Part No.	Qty	Size
VC600	Box of 100	M
VC886	10 x Boxes of 100	M
VC601	Box of 100	L
VC887	10 x Boxes of 100	L
VC603	Box of 100	XL
VC889	10 x Boxes of 100	XL



Latex Gloves - Powder FREE

Part No.	Qty	Size
VC541	Box of 100	S
VC578	10 x Boxes of 100	S
VC539	Box of 100	M
VC576	10 x Boxes of 100	M
VC540	Box of 100	L
VC577	10 x Boxes of 100	L
VC542	Box of 100	XL
VC579	10 x Boxes of 100	XL



KS TOOLS Mechanics Anti-Vibration Gel Gloves

Absorbs and dissipates repeated impacts and shocks.

- Designed for handling power tools, industrial tools and any tools with repetitive vibration.

Part No.	Qty	Size	EN388 Rating
K310.0250	1 Pair	L	2112
K310.0255	1 Pair	XL	2121
K310.0260	1 Pair	XXL	2121



KS TOOLS Mechanics Grip Gloves

Designed for maximum comfort when used in cold, wet and dirty environments.

- Palm covered with rubber nodules for maximum grip.
- Hard wearing 'Dry Suit' material technology for maximum protection.

Part No.	Pack of	Size	EN388 Rating
K310.0350	1 Pair	L	2121
K310.0355	1 Pair	XL	2121
K310.0360	1 Pair	XXL	2121





NEW

DELTA PLUS Heat Tolerant Glove

100% polyester. PURE latex coating on palm and fingertips. Gauge 13.

Part No.	Qty	Size	EN388 Rating
WS320	1 Pair	M	2142
WS321	1 Pair	L	2142
WS322	1 Pair	XL	2142



PVC Gloves

With knitted wrist.

Part No.	Qty	Description	EN388 Rating
WS6	5 Pairs	PVC Gloves	3131



NEW

DELTA PLUS Heat Tolerant Winter Glove

Inside: 100% acrylic gauge 10.
Outside: 100% polyamide gauge 15.
Full latex coating of the hand.
Second foam latex coating on palm and fingertips.

Part No.	Qty	Size	EN388 Rating
WS325	1 Pair	L	2231
WS326	1 Pair	XL	2231



Yellow Kriss-Kross Gripper Gloves

Heavy weight string knitted base with coarse PVC lattice pattern on both sides providing excellent dexterity and grip.

Part No.	Pack of	Size	EN388 Rating
WS40	5 Pairs	L	1000



Cotton & Chrome Gloves

Chrome palm and cotton liner.
One size fits all.

Part No.	Pack of	Descriptions	EN388 Rating
WS46	5 Pairs	Cotton & Chrome Gloves	1000



Knit Wrist Stockinette Gloves

One size fits all.

Part No.	Pack of	Descriptions	EN388 Rating
WS45	10 Pairs	Stockinette Gloves	1000



Rigger Gloves

Canadian pattern.
Chrome leather palms.

Part No.	Pack of	Description	EN388 Rating
WS7	5 Pairs	Rigger Gloves	2111X



BEST SELLER

Hide Rigger Gloves - Heavy Duty

Conforms to EN388, EN420
Cow split leather glove, double palm with rubberized cuff and half lined. Colours may vary.

Part No.	Pack of	Size	EN388 Rating
WS42	5 Pairs	L	4244



14" PVC Gauntlets

Cotton lined.
Conforms to EN388, EN420.

Part No.	Pack of	Description	EN388 Rating
WS41	2 Pairs	14" PVC Gauntlets	2003



Household Rubber Gloves

Medium weight.
Cotton flock lined.
Conforms to EN420.

Part No.	Pack of	Size	EN388 Rating
WS43	12 Pairs	M	1000
WS44	12 Pairs	L	1000



Rubber Gloves

Black. Heavy duty acid resistant for platers.

Part No.	Qty	Description	EN388 Rating
WS24	1 Pair	Rubber Gloves	3121



Gauntlets

With tough cotton fleece lining, 5" cuffs. Colour may vary.

Part No.	Qty	Description	EN388 Rating
WS8	1 Pair	Gauntlets	4133



Bump Cap

Black, adjustable.
EN 812

Part No.	Qty	Description
WS35	1	Bump Cap



DELTA PLUS Impact Resistant Bump Cap

Approved to EN812:2012.

- Highly ventilated polyester/Cotton with mesh fabric
- Lined with polyethylene and comfortable EVA foam shell to absorb shocks.

Part No.	Qty	Description	Size
WS403	1	Bump Cap	52-56 cm



DELTA PLUS Safety Helmets

Approved to EN397:2012 / A1:2012 / EN50365:2002.

Electrical insulation up to 100V.A.C (Class 0)
UV-resistant high density polyethylene or polypropylene.
Low density polyethylene cradle with 8 fixing points.

- Sweat band
- Standard holes for accessories and anchorage for chin straps with 2 or 4 points

Part No.	Qty	Colour
WS417W	1	White
WS417Y	1	Yellow



DELTA PLUS Dual-Shell Safety Helmet with Retractable Visor

ABS dual shell safety helmet with polycarbonate retractable visor.
Electrical insulation up to 1000 V.A.C. or 1500 V.D.C, protection against arc fault Class 1 (GS-ET 29). Visor with anti-Fog N and anti-scratch K treatments and protection against electrical arcs, and molten metals or hot liquids projections.

- One-D Rotor clamping system: head size 53 to 63 cm
- 2 headband positions
- Retro-reflective stickers

Part No.	Qty	Description
WS420	1	Safety Helmet with Visor





Face Shield

Complete with brow guard/harness and 20 cm (8") polycarbonate visor. BS EN 166/1/B9.

Part No.	Qty	Description
WS18	1	Face Shield with Clear Visor
WS18C	1	Replacement Clear Visor
WS18S	1	Replacement Anti-Glare Visor



Ski Style Wide Vision Safety Goggles

CE marked. 99.9% UV/B protection. EN166 / EN170 / EN175. Soft rubber body provides exceptional comfort. Withstands high temperatures. Fits over most spectacles. Anti scratch/mist.

Part No.	Qty	Lens Colour	Markings
WS1508	1	Clear	1 BT 9 0



Wide Vision Welding Goggles

CE marked. 99.9% UV/B protection. EN166 / EN171 / EN175. Fits over most spectacles. Anti scratch/mist.

Part No.	Qty	Lens Colour	Markings
WS1511	1	Shade 5	4-5 1 BT 9 0



Grinding Goggles

BS EN 166/1/B.

Part No.	Qty	Description
WS23	1	Grinding Goggles



Safety Goggles - Wide Vision

BS 679/1959.

Part No.	Qty	Description
WS3	1	Safety Goggles



Lightweight Wraparound Safety Spectacles with Safety Cord

CE marked. 99.9% UV/B protection. EN166 / EN170 (*EN172). Outstanding field of vision, exceptional protection. Adjustable arms/lens angle. Anti scratch. Integral nose piece.

Part No.	Qty	Lens Colour	Markings
WS1491	1	Clear	2-1.2 1 FT 0



Wraparound Safety Spectacles with Rubber Nose Pads

CE marked. 99.9% UV/B protection. EN166 / EN170 (*EN172) (†EN171). Comfortable lightweight design, rubber nose pads and soft temple tips. Anti scratch.

Part No.	Qty	Lens Colour	Markings
WS1498	1	Clear	2-1.2 1 FT 0
WS1500	1	Shade 5†	4-5 1 FT 0



Frameless Adjustable Wraparound Safety Spectacles

CE marked. 99.9% UV/B protection. EN166 / EN170 (*EN172). Adjustable temple length. Anti scratch. Lightweight. Integral nose piece.

Part No.	Qty	Lens Colour	Markings
WS1505	1	Clear	2-1.2 1 FT 0
WS1506	1	Smoke*	5-3.1 1 FT 0



DELTA PLUS 'Metal Free' Single Lens Safety Glasses

Polycarbonate. CE marked. 99.9% UV/B protection. Approved to EN166, EN172:2002 Ultraviolet filters. Metal free: dielectric.

- Ideal for spraybooths
- Ultra light: 18g
- Ultra flexible
- Anti scratch

Part No.	Qty	Lens Colour	Markings
WS1516	1 Pair	Clear	1 FT/FT
WS1517	1 Pair	Smoke	1 FT/FT



Safety Spectacles

Polycarbonate over specs. BS EN 166/1/F.

Part No.	Pack of	Description
WS17	10	Safety Spectacles



DELTA PLUS Twin Lens Safety Glasses

Polycarbonate CE marked.
99.9% UV/B protection. Approved to EN166, EN172:2002 Ultraviolet filters

- Polycarbonate twin lens glasses
- Soft tips
- Anti scratch
- Twin material anti-slip arms
- Soft TPE nose piece
- Anti mist (WS1514 only)

Part No.	Qty	Lens Colour	Markings
WS1514	1 Pair	Clear	ANSI Z87+
WS1515	1 Pair	Gradient	1 FT/FT



DELTA PLUS LYVIZ Coated Single Lens Easy Clean Safety Glasses

Polycarbonate. CE marked. 99.9% UV/B protection.
Approved to EN166, EN172:2002 Ultraviolet filters

- Removable Foam Frame
- LyViz treatment : oleophobic and hydrophobic coating enables user to clean lenses with a quick wipe and eliminates the danger of removing them whilst working
- Adjustable nylon arms. Side protection

Part No.	Qty	Lens Colour	Markings
WS1522	1 Pair	Clear	1 FT/FT ANSI Z787+



DELTA PLUS Ergonomic Safety Glasses with Removable Foam

CE marked. 99.9% UV/B protection. Approved to EN166, EN172:1994 / A1:2000 / A2:2001 Sunglare filters for industrial use C/w protective pouch and neck cord.

- Polycarbonate lens
- Sports elastic strap
- UV/IR Anti-mist
- 'Soft comfort' removable foam frame for dust and shock protection
- Twin material curved arms
- Anti-slip soft TPE nose piece
- Anti-scratch

Part No.	Qty	Lens Colour	Markings
WS1524	1 Pair	Gradient	1 FT/FT



DELTA PLUS Helium Metal Detectable Safety Glasses

Ultra light polycarbonate single lens glasses.
Extra fine frame. Suitable for long duration wear.

- Metallically charged blue frame visually detectable by X-ray and magnetism
- Blue tint with excellent transmission factor (80%)
- Extra fine frame
- Suitable for the food industry
- Comfortable for indoor use
- Compatibility with noise cancelling headphones

Part No.	Qty	Lens Colour	Markings
WS1550	1 Pair	Blue	1FT/FT



DELTA PLUS Monobloc Single Lens Safety Glasses

Polycarbonate. CE marked.
99.9% UV/B protection. Approved to EN166,
EN172:2002. Ultraviolet filters.

- Integrated nose piece
- Soft flat spatula type arms
- Easy to use with safety helmet and ear defenders and disposable masks
- Side protection
- Anti Scratch

Part No.	Qty	Lens Colour	Markings
WS1494	1 Pair	Clear	1 FT/FT ANSI Z787+
WS1495	1 Pair	Smoke	1 FT/FT ANSI Z787+
WS1496	1 Pair	Yellow	1 FT/FT ANSI Z787+
WS1497	1 Pair	Mirror	1 FT/FT ANSI Z787+

Eye Protection - Markings

This range of eye protectors are suitable for use in accordance with the marking of the lens and frame.



UV 400

UV 400 protection provides protection against 99 to 100% of UVA and UVB ultraviolet radiation. It is called UV 400 because it blocks all rays of light up to a wavelength of 400 nanometers.

Frame Marking

Standard Number

- EN166** = Personal Eye Protection (technical performance standard)
- EN175** = Welding Personal Protection (equipment for eye and face protection during welding and allied processes)

Symbol for Mechanical Strength

- TF** = Low Energy Impact (45m/s)
- BT** = Medium Energy Impact (10 m/s) - Goggles

Field(s) Of Use

- 9** = Resistance to Molten (Metal and Hot Solids) - Goggles
- 3** = Resistance to Liquids (Droplets or Splashes) - Goggles

Ocular Marking

Scale Number (first digit)

- 2** = EN170 - Ultraviolet Filters (transmittance requirements and recommended utilisation)
- 4** = EN171 - Infrared Filters (transmittance requirements and recommended use)
- 5** = EN172 - Solar Radiation Filters (sun glare filters for industrial use)

Shade Number (second and third digit)

- 1.2** = Clear / Amber
- 3.1** = Smoke / Green / Blue Mirror
- 5** = Shade 5

Optical Class

- 1** = High Optical Quality (suitable for occasional wear)

Symbol for Original Ocular

- 0** = Original Ocular EN170 - Ultraviolet Filters (transmittance requirements and recommended utilisation)





KN95 Face Masks

Meets the standard GB/T 2626-2006. 5-layer mask with stretchable ear-loops. Non-woven polypropylene fabric.

- Adjustable nose piece form-fit design provides high breathability for maximum comfort
- Excellent anti-fog and anti-haze properties
- Hypoallergenic - Latex and fibreglass-free

Part No.	Box of	Description
WS95	10	KN95 Face Masks



Surgical Type Face Masks

3-layer pleated mask with stretchable ear-loops.

- Adjustable nose piece form-fit design provides high breathability for maximum comfort
- Hypoallergenic - 100% latex and fibreglass-free

Part No.	Box of	Description
WS1	50	Surgical Type Face Masks



DELTA PLUS White Hygiene Masks

- Non-woven polypropylene 160 g/m².
- Elasticated straps and nose clip for adjustment.

Part No.	Box of	Description
WS5	50	Hygiene Masks



DELTA PLUS Moulded Disposable FFP2 Masks + Valve

Approved to EN149:2001 / A1:2009

- Nose clip for adjustment
- Foam edge under nose clip
- High performance exhalation valve

Part No.	Box of	Description
WS28	10	FFP2 + Valve



DELTA PLUS Moulded Disposable Masks FFP1 + Valve

Approved to EN149:2001 / A1:2009

- Nose clip for adjustment
- Foam edge under nose clip
- High performance exhalation valve

Part No.	Box of	Description
WS412	10	FFP1 + Valve



MOLDEX Smart Pocket FFP2 Masks + Valve

Approved to EN149:2001.

- Individually packaged, fits into your pocket.
- Protected from dust and kept hygienic before use.

Part No.	Box of	Description
MX2475	10	FFP2 + Ventex Valve



DELTA PLUS Moulded Disposable FFP2 Masks

Approved to EN149:2001 / A1:2009

- Nose clip for adjustment
- Foam edge under nose clip

Part No.	Box of	Description
WS27	20	FFP2

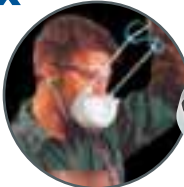

MOLDEX Smart Solo FFP Masks

Approved to EN149:2001.

- Even with gloves putting the '1-Strap' mask on and taking it off is quick, simple and safe.

Part No.	Box of	Description
MX2395	20	FFP1 + Ventex Valve
MX2495	20	FFP2 + Ventex Valve



MOLDEX Smart Series FFP Masks + Valve

Approved to EN149:2001.

- The clip and adjustable strap make putting the mask on and off easier.
- During breaks the mask can be worn around the neck.

Part No.	Box of	Description
MX2385	20	FFP1 + Ventex Valve
MX2485	20	FFP2 + Ventex Valve
MX2505	10	FFP3 + Ventex Valve

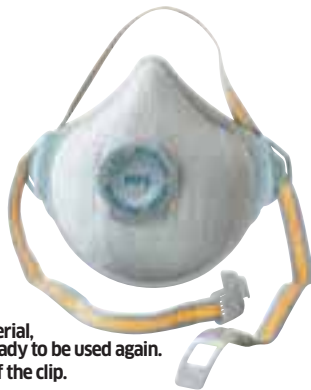

MOLDEX AIR Plus Reusable FFP3 Masks

Approved to EN149:2001.

- Washable full face seal.
- The full face seal is made of soft Kraton material, so it can be wiped clean leaving the mask ready to be used again.
- Strap length can be adjusted with the help of the clip.

Part No.	Box of	Description
MX3405	5	FFP3 + Ventex Valve

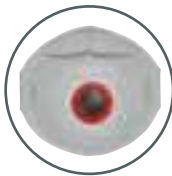

DELTA PLUS Moulded Disposable FFP3 Masks + Valve

Approved to EN149:2001 / A1:2009

- Nose clip for adjustment
- EVA edge for extra comfort under nose clip
- High performance exhalation valve

Part No.	Box of	Description
WS415	10	FFP3 + Valve

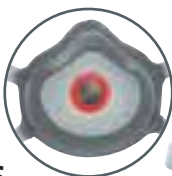

DELTA PLUS Moulded Disposable FFP3 Masks + Valve

Approved to EN149:2001 / A1:2009

- Non-woven synthetic fibre
- Wide adjustable strap
- Complete ultra soft face joint ring
- High performance exhalation valve

Part No.	Box of	Description
WS416	5	FFP3 + Valve



Half Mask

Complete with A1 P2 Dust filter cartridges suitable for automotive refinish workshops. Cartridges colour coded to European norms: EN14387:2004/A1:200843 and EN143:2000/A1:2006.

- Durable manufactured from natural rubber and features fully adjustable straps ensuring a comfortable and efficient fit with maximum protection
- The A1 P2 cartridges offer protection from organic vapours and gases and are replaceable

Part No.	Qty	Description
WSS0	1 Kit	Half Mask
WSS1	4	Replacement Cartridges



MOLDEX Compact Half Face Mask

Tested and certified to EN 405:200. Maintenance free and ready for use.

- Wide field of vision
- Unrestricted freedom of movement
- Lightweight and comfortable
- FlexFit: automatically adjusts to different face shapes
- Pleated Filter Technology: low breathing resistance, high durability

Part No.	Pack Qty	Protection Level
MX5120	1	FFA1P2 R D
MX5230	1	FFA2P3 R D
MX5330	1	FFA1B1E1P3 R D
MX5430	1	FFA1B1E1K1P3 R D



Looking for Full Face Masks?

Our range of full face masks with replacement filters features overleaf



MOLDEX



MOLDEX 7000 Series Half Face Mask

Uses Easylock filters.

- Lightweight
- Gentle on skin
- Easy to clean and maintain

Part No.	Qty	Description
MX7002	1	Medium Mask
MX7003	1	Large Mask
MX7122	1 Kit	Medium Mask & x 2 A1P2 Filters
MX7232	1 Kit	Medium Mask & x 2 A2P3 Filters
MX7432	1 Kit	Medium Mask & x 2 ABEK1P3 Filters

MOLDEX



MOLDEX 9000 Series Full Face Mask

Extremely lightweight with excellent periphery vision. The lens is made from scratch resistant polycarbonate and is easy to clean thanks to the hydrophobic coating.

Uses Easylock filters.

- Panoramic lens
- Easy to clean and maintain
- Class 2

Part No.	Qty	Description
MX9002	1	Medium Mask
MX9003	1	Large Mask

MOLDEX



MOLDEX EasyLock Filters For 7000 + 9000 Series

EasyLock particulate filters can either be connected to the EasyLock gas cartridges or directly with the mask body.

- Revolutionary filter system
- No need for additional clips or holders
- Different filters can be combined

Part No.	Pack Qty	Type
MX9100	1 Pair	A1 Gas Filters
MX9400	1 Pair	ABEK1 Gas Filters
MX9020	1 Pair	P2 R D Particulate Filters
MX9030	1 Pair	P3 R D Particulate Filters
MX9200	1 Pair	A2 Gas Filters
MX9500	1 Pair	A2B2E1 Gas Filters
MX9600	1 Pair	AX Gas Filters (Single Use)

MOLDEX



MOLDEX 'Spark Plugs' Disposable Earplugs Dispenser Stations with Earplugs

The dispensing system is made of recyclable material. As the dispenser mechanism is automatically replaced with every refill plugs remain hygienic. (Mounting bracket shown available separately).



Part No.	Contains	Description
MX7825	250 Pairs	Small Station
MX7850	500 Pairs	Large Station
MX7060	1	Mounting Bracket c/w Fittings

MOLDEX

MOLDEX 'Spark Plugs' Disposable Earplugs

Approved to EN352-2:2002. Contoured shape, comfortable PU foam earplugs. Suited to protect against long-term exposure. Soft material that is easy to insert.



Part No.	Pack of	SNR	High, Medium, Low
MX7800	20 Pairs	35dB	(34, 32, 31dB)

MOLDEX

MOLDEX 'Mellows' Disposable Earplugs

Approved to EN352-2:2002. Contoured shape, comfortable PU foam earplugs. Suited to protect against long-term exposure. Soft material that is easy to insert.



- Protects against lower noise levels
- Designed to keep you in touch with your environment and aid communication

Part No.	Pack of	SNR	High, Medium, Low
MX7600	20 Pairs	22dB	(26, 18, 12dB)

MOLDEX

MOLDEX 'Jazz-Band' Reusable Banded Earplugs

Approved to EN35-2:1991. The convenient option against intermittent noise throughout the day. Dual material technology reduces noise transmission.

- Complete with neck cord with safety release mechanism



Part No.	Pack of	SNR	High, Medium, Low
MX6700	1 Pair	23dB	(25, 19, 18dB)
MX6750	2 Pairs	Replacement Pods	

**MOLDEX 'Pura-Band'
Reusable Banded Earplugs**

Approved to EN35-2:1991.
The convenient option against
intermittent noise throughout the day.
Durable and washable pods
made of soft thermoplastic.

Part No.	Pack of	SNR	High, Medium, Low
MX6600	1 Pair	22dB	(24, 18, 17dB)



**DELTA PLUS
Linked Folding Ear Plugs**

Approved to EN352-2
• Can be worn under the chin
• PU earplugs with headband in
polypropylene.
• Ideal for intermittent or occasional wear.
• Individual pack

Part No.	Qty	SNR	High, Medium, Low
WS407	1 Pair	24dB	(25, 20, 19dB)



**MOLDEX
'Rockets Cord'
Reusable Earplugs**

Approved to EN352-2:2002.
For long term exposure to noise.
Supplied in a compact plastic storage case.

- Washable plugs made of soft and durable Kraton material.
- Dual material ensures easy insertion & maximum comfort.

Part No.	Pack of	SNR	High, Medium, Low
MX6401	1 Pair	30dB	(31, 26, 24dB)



**DELTA PLUS
High Visibility
Disposable Corded Ear Plugs**

Approved to EN352-2
• HV disposable PU earplugs with plastic cord.
• Ergonomic design for more comfort.

Part No.	Qty	SNR	High, Medium, Low
WS404	20 Pairs	34dB	(33, 31, 30dB)



**JSP Ear Plugs
- Reusable Type**

Supplied with cord.

Part No.	Pack of	Description
WS20	5 Pairs	Reusable Ear Plugs



Ear Defenders

Glass filled nylon ear cups,
polystyrene pads with
flexible foam protection.
BS 6344 Part 2.
Frequency range: 1000 - 8000 Hz.

Part No.	Qty	Description
WS15	1 Pair	Ear Defenders



**BEST
SELLER**



**DELTA PLUS
Ear Defenders**

Approved to EN352-1.
ABS and synthetic foam cups. ABS headband.
• Adjustable in height to give an individual fit.
• Padded and flexible.

Part No.	Qty	SNR	High, Medium, Low
WS408	1 Pair	26dB	(30, 24, 15dB)



**DELTA PLUS
Foldable Ear
Defenders**

Approved to EN352-1.
Supplied with carry bag and belt clip.
• Adjustable in height to give an individual fit
• ABS and synthetic foam cups
• Double plastic headband
• Can be folded away into a compact size for easier storage and hygiene

Part No.	Qty	SNR	High, Medium, Low
WS409	1 Pair	30dB	(33, 29, 19dB)



**MOLDEX
'M1' Ear Defenders**

Approved to EN352-1.
For protection from intermittent noise
or for those who cannot achieve a safe and
comfortable fit with earplugs. Metallic colour
'SoftCoat' material with padded steel headband,
comfortable and robust.

- 6 adjustment points to give an individual fit
- Unique design can be folded away into a compact size for easier storage and hygiene

Part No.	Pack of	SNR	High, Medium, Low
MX6100	1 Pair	31dB	(31, 29, 21dB)



**MOLDEX
'M2' Ear Defenders**

Approved to EN352-1. Metallic colour 'SoftCoat'
material. Moulded cup grips make fitting and
alignment quick and easy. Wide range of cup
adjustment gives excellent pressure distribution for all sizes.

- Can be worn behind the neck, ideal when using head gear

Part No.	Pack of	SNR	High, Medium, Low
MX6200	1 Pair	27-30dB	(31, 26, 17dB)





Hi-Vis Vest - Orange

Conforms to EN 471 Class 2.
100% polyester fabric hook & loop fastening.

Part No.	Qty	Size	Colour
WS459L	1	L	Fluorescent Orange
WS459XL	1	XL	Fluorescent Orange



Hi-Vis Vest - Yellow

Conforms to EN 471 Class 2.
100% polyester fabric hook & loop fastening.

Part No.	Qty	Size	Colour
WS400	1	M	Fluorescent Yellow
WS401	1	L	Fluorescent Yellow
WS402	1	XL	Fluorescent Yellow



NEW

DELTA PLUS Bodywarmer - Black/Grey

PVC-coated polyester bodywarmer.

- Collar with polar lining for optimal comfort
- 3 pockets
- Extra comfort opening on both sides
- Lower back protection

Part No.	Qty	Size	Colour
WS458M	1	M	Grey-Black
WS458L	1	L	Grey-Black
WS458XL	1	XL	Grey-Black



DELTA PLUS '2 in 1' Hi-Vis Bomber Jacket/ Body Warmer

Approved to EN343:2003
A1:2007 / EN ISO 20471:2013
High visibility Class 3.
Silver coloured shoulder-belt and parallel assembly.

- Bomber jacket with removable sleeves
- Collar with polar lining for optimal comfort
- Knitted cuffs and at bottom of garment
- 4 x Pockets



Part No.	Qty	Size	Colour
WS452L	1	L	Fluorescent Yellow
WS452XL	1	XL	Fluorescent Yellow



DELTA PLUS Hi-Vis Parka

Approved to EN ISO 13688:2013 / EN ISO 20471:2013 / EN343:2003
A1:2007. High visibility Class 3.
Silver colour shoulder-belt and parallel assembly

- Warm parka waterproof seams
- Fixed hood
- Fastening with zip under Hook & Loop storm flap
- 4 x Pockets



Part No.	Qty	Size	Colour
WS454L	1	L	Fluorescent Yellow/Navy Blue
WS454XL	1	XL	Fluorescent Yellow/Navy Blue



DELTA PLUS Softshell Jacket

- Fastening with zip under storm flap
- Bottom of sleeves with bias finishing
- 5 x Pockets
- Adjustable bottom of garment with elastic drawstring



Part No.	Qty	Size	Colour	Chest
WS453M	1	M	Grey-Black	48/50
WS453L	1	L	Grey-Black	52/54
WS453XL	1	XL	Grey-Black	56/58

DELTA PLUS Rain Suit

Approved to EN ISO 13688:2013 / EN343:2003 A1:200. Weatherproof Rating 3 -1*.

JACKET:

- Fastening with zip under storm flap
- Fixed hood
- Raglan sleeves and adjustable cuffs with press-studs
- 2 x Pockets

TROUSERS:

- Elasticated waist
- Adjustable bottom of legs with press-studs
- 2 x Hand slits

Part No.	Qty	Size	Chest
WS455L	1 Set	L	52/54
WS455XL	1 Set	XL	56/58



DELTA PLUS Cargo Style Work Trousers

Approved to EN ISO 13688:2013. Navy with royal blue trim

- Elasticated waist on both sides.
- 7 pockets including 1 ruler.
- Twill 65% polyester 35% cotton 245 g/m².

Part No.	Qty	Size	Waist
WS450M	1	M	38/40
WS450L	1	L	42/44
WS450XL	1	XL	46/48



DELTA PLUS Disposable Type 5/6 Coverall

Approved to EN ISO 13982-1:2004 / A1:2010 / EN13034:2005 / A1:2009

- 100% SMS
- Fastening with zip under flap.
- Elasticated round head, waist, cuffs and ankles.
- Individual pack.
- 0% Silicone/Latex.
- Anti-Static.
- Breathable fabric.
- Non woven 100% SMS 50 g/m².

Part No.	Qty	Size
WS457L	1	L
WS457XL	1	XL



DELTA PLUS Working Overalls

Approved to EN340:2003. Navy with orange trim.

- Front zip fastening with bias finishing
- Elasticated waist & cuffs
- 7 x Pockets
- Twill 65% polyester 35% cotton 235 g/m²

Part No.	Qty	Size	Chest
WS451M	1	M	48/50
WS451L	1	L	52/54
WS451XL	1	XL	56/58



DELTA PLUS Gel Kneepads

Approved to EN14404:2004 / A1:2010

- Outside anti slip shell.
- Elastic hook & loop band to maintain the knee.
- Adjustable strips in elastic hook & loop.

Part No.	Qty	Description
WS418	1 Pair	Gel Kneepads



DELTA PLUS Kneepads for Trousers Inserts

Approved to EN14404:2004 / A1:2010. Polyethylene foam.

Part No.	Qty	Size
WS419	1 Pair	200 x 150 mm





DELTA PLUS Lightweight Composite Water Resistant Leather Hiker Safety Boots - Black

Approved to EN ISO 20344:2011 / EN ISO 20345:2011.
 Outsole: Ladder lateral grips, cleats with grip on all indoor and outdoor surfaces.
 Upper: Pigmented split leather, S3 water resistant treatment. Insole: Ultra flexible anti-perforation composite insole.

- Ultra light weight
- Composite toe cap 200 joule, lighter than steel, non-conductive material
- Non metallic footwear
- Ideal for agriculture, construction, craftsmen, light industry, service logistics & mining

Part No.	Qty	Size UK (EU)	Class	Performance
WS55008	1 Pair	8 (42)	S3	SRC
WS55009	1 Pair	9 (43)	S3	SRC
WS55010	1 Pair	10 (44.5)	S3	SRC



DELTA PLUS Water Resistant Leather Hiker Safety Boots - Black

Approved to EN ISO 20344:2011 / EN ISO 20345:2011.
 Upper: Pigmented split leather, S3 water resistant treatment.
 Outsole: Ladder lateral grips, toe and heel grips.

- Comfortable wider fit
- Anti fatigue sole with integrated flexing zone
- Reflective strip
- Reinforced toe protection with PU cover (Bumper Cap System)
- Ideal for agriculture, construction, craftsmen, light industry, service logistics & mining

Part No.	Qty	Size UK (EU)	Class	Performance
WS55708	1 Pair	8 (42)	S3	SRC
WS55709	1 Pair	9 (43)	S3	SRC
WS55710	1 Pair	10 (44.5)	S3	SRC



DELTA PLUS Leather Safety Boots - Black

Approved to EN ISO 20344:2011 / EN ISO 20345:2011.
 Upper: Pigmented split leather. Lining: Polyamide mesh.
 Insole: Fixed - Polyamide on EVA. Outsole: Injected dual-density PU.

- Ideal for construction, craftsmen, service logistics, light industry and mining

Part No.	Qty	Size UK (EU)	Class	Performance
WS55308	1 Pair	8 (42)	S1P	SRC
WS55309	1 Pair	9 (43)	S1P	SRC
WS55310	1 Pair	10 (44.5)	S1P	SRC



DELTA PLUS Nubuck Leather Hiker Safety Boots - Sand

Approved to EN ISO 20344:2011 / EN ISO 20345:2011.
 Upper: Cow Nubuck. Midsole: Steel. Outsole: PU/rubber.
 Lining: Polyester. Insole: Removable, Polyester 4 mm EVA.

- Ideal for craftsmen, light industry and service logistics

Part No.	Qty	Colour	Size UK (EU)	Class	Performance
WS55808	1 Pair	Sand	8 (42)	S1P HRO	SRC
WS55809	1 Pair	Sand	9 (43)	S1P HRO	SRC
WS55810	1 Pair	Sand	10 (44.5)	S1P HRO	SRC
WS55908	1 Pair	Black	8 (42)	S1P HRO	SRC
WS55909	1 Pair	Black	9 (43)	S1P HRO	SRC
WS55910	1 Pair	Black	10 (44.5)	S1P HRO	SRC



DELTA PLUS Leather Fur-Lined Rigger Boots - Beige

Approved to EN ISO 20344:2011 / EN ISO 20345:2011.
 Outsole: Injected dual density PU with front PU reinforcement.
 Lining: Acrylic fur. Insole: Removable preformed polyester on EVA.
 Upper: Cowhide leather, water resistant treatment S3 with TPR heel protection.

- Ideal for agriculture, construction, craftsmen, light industry, service logistics and mining.

Part No.	Qty	Size UK (EU)	Class	Performance
WS56008	1 Pair	8 (42)	S3 CI	SRC
WS56009	1 Pair	9 (43)	S3 CI	SRC
WS56010	1 Pair	10 (44.5)	S3 CI	SRC



DELTA PLUS Mesh/Full Grain Leather Safety Trainers - Black

Approved to EN ISO 20344:2011 / EN ISO 20345:2011.
 Upper: Leather/mesh. Lining: Polyester.
 Outsole: Cemented PU/rubber for better abrasion resistance.

- Ultra flexible anti-perforation composite insole
- Composite toe cap 200 joule, lighter than steel, non-conductive material
- Ideal for craftsmen, light industry and service logistics

Part No.	Qty	Size UK (EU)	Class	Performance
WS55408	1 Pair	8 (42)	S1P HRO	SRC
WS55409	1 Pair	9 (43)	S1P HRO	SRC
WS55410	1 Pair	10 (44.5)	S1P HRO	SRC



DELTA PLUS Lightweight Slip-On Safety Shoes

Approved to EN ISO 20344:2011 /
EN ISO 20345:2011. Upper: Polyester and cotton.
Insole: Removable preformed polyester on EVA. Midsole: Injected single density PU.

- Ultra lightweight for all day comfort
- Ideal for craftsmen, light industry and service logistics

Part No.	Qty	Colour	Size UK (EU)	Class	Performance
WSS5104	1 Pair	Blue	4 (37)	S1P	SRC
WSS5105	1 Pair	Blue	5 (38)	S1P	SRC
WSS5106	1 Pair	Blue	6 (39)	S1P	SRC
WSS5107	1 Pair	Blue	7 (40.5)	S1P	SRC
WSS5108	1 Pair	Blue	8 (42)	S1P	SRC
WSS5204	1 Pair	Black	4 (37)	S1P	SRC
WSS5205	1 Pair	Black	5 (38)	S1P	SRC
WSS5206	1 Pair	Black	6 (39)	S1P	SRC
WSS5207	1 Pair	Black	7 (40.5)	S1P	SRC
WSS5208	1 Pair	Black	8 (42)	S1P	SRC



DELTA PLUS Suede Split Leather Safety Trainers

Approved to EN ISO 20344:2011 /
EN ISO 20345:2011.
Upper: Leather/mesh. Lining: Polyester.
Outsole: Cemented PU/rubber for better abrasion resistance.

- Ultra flexible anti-perforation composite insole
- Composite toe cap 200 joule, lighter than steel, non-conductive material
- Ideal for craftsmen, light industry and service logistics

Part No.	Qty	Size UK (EU)	Class	Performance
WSS5508	1 Pair	Blue/Grey 8 (42)	S1P HRO	SRC
WSS5509	1 Pair	Blue/Grey 9 (43)	S1P HRO	SRC
WSS5510	1 Pair	Blue/Grey 10 (44.5)	S1P HRO	SRC
WSS5608	1 Pair	Biege 8 (42)	S1P HRO	SRC
WSS5609	1 Pair	Biege 9 (43)	S1P HRO	SRC
WSS5610	1 Pair	Biege 10 (44.5)	S1P HRO	SRC

Safety Boots + Footwear - Selection Guide

To make selection easier, safety boots and footwear normally carries a simple two or three letter code which defines the basic safety standards for that particular product. Typically this begins with an S for 200 Joule toe caps and less commonly P for 100 Joule toe caps; additional properties may be indicated by the use of further codes or pictograms.

As a basic requirement safety footwear must have a 200 joule toe cap. Other properties that may be included are: penetration resistance (midsole protection), conductive, anti-static, insulated against heat or cold, energy absorbing, outsole resistant to hot contact, water resistant.

Summary of Basic Ratings

- SB** Safety basic, 200 joules Toe Protection, Oil Resistant outer sole. (Minimum Requirement)
- SBP** As SB plus Mid-Sole for penetration resistance.
- S1** As SB plus Anti-Static properties and fully enclosed Energy Absorbing heel area.
- S1P** As S1 plus Mid-Sole for penetration resistance.
- S2** As S1 plus resistance to Water Penetration and absorption.
- S3** As S2 plus Mid-Sole for penetration resistance and cleated outsole

Toe Protection (SB)

Your toes are a very vulnerable part of your body, especially in a workplace. Toe protection must withstand a 200 joule impact. Joule is the unit of energy and this standard is purposefully specific. Something heavy falling from a low height could have a lot less energy than something lighter from a much higher height. As well as impacts, the toe area must withstand a resting mass of well over 1000kg.

Most people have heard of steel toe cap boots but the protection doesn't have to be steel. In fact there are advantages to alternatives. Non-metallic protection can be equally as strong but lighter.

Midsole Penetration Protection (P) - SBP, S1P, S3

Sharp objects where we walk and stand are a significant risk not only in the workplace but also outdoors and at home. Midsole protection will guard against nails and other objects. To meet this standard the footwear must be able to resist a penetration force of 1100N. Midsole protection is provided in one of these methods: a stainless steel insert in the sole, aluminium insert in the sole, or by Kevlar insole. The Aluminium and Kevlar solutions are the most flexible and lightest and cover the greatest area of the foot. Kevlar insoles also offer much higher thermal insulation.

E Energy Absorption

Energy Absorption in the heel region

WRU Water Resistant Upper

Water resistant upper; not used on all rubber or polymeric footwear.

HRO Heat Resistant

Heat resistant outsole: to resist 300°C for 60 seconds

CI Insulation against Cold

Insulation against cold: tested for 30 minutes at 1-20°C

HI Insulation against heat

Insulation against heat: tested for 30 minutes at 150°C

ESD Electro-Static Discharge

ESD footwear is designed for the electronics and explosives industry and meet ESD CEI EN 61340-5-1 standard.

Non-metallic footwear

Safety footwear containing no metal parts is ideal for workplaces with metal detectors like airports, eliminating the hassle of removing them.

All safety footwear can have more features than are listed above but these are the minimum requirements to meet each of the safety ratings and the most common.

Options for specific protection are categorised as:

- A** Antistatic: Comes as standard with level S1, S2 and S3
- E** Energy absorbing heel: Comes as standard with level S1, S2 and S3
- P** Puncture Resistant: Comes as standard with level SBP, S1P and S3
- HRO** Heat Resistant Outsole: Comes as standard with level SB, S1, S2 and S3

Slip Resistance

The safety features of footwear, including slip resistance, are also tested according to a set of European test standards written into EN ISO 20344:2011 Personal protective equipment. Test methods for footwear.

Depending on the test conditions chosen, footwear tested according to the EN standards is now marked with one of the following codes: SRA, SRB, SRC.

The codes indicate that the footwear has met the specified requirements when tested as follows:

- SRA** Tested on ceramic tile wetted with dilute soap solution
- SRB** Tested on smooth steel with glycerol
- SRC** Tested under both the above conditions.





DELTA PLUS Restraint Work Harness Kit

Approved to EN355:2002 / EN361:2002 / EN363 : 2008 / EN364 : 1992 / EN365 : 2004.
Ready for use kit:

- 1 fall arrester anchorage point harness (back).
- 2 x Adjustment loops
- 2 x Adjustable side plates with lanyard
- 1 x Connector

Part No.	Qty	Description	Size
WS472	1 Kit	Work Harness Kit	L

Lanyard in irremovable stranded rope Ø 12 mm. Length 1.50 m.



DELTA PLUS 'Riplight System II'[®] Fall Arrester Harness

Approved to EN361:2002 / EN363:2008 / EN364:1992 / EN365:2004 / EN355:2002 / EN361:2002.
Elasticated harness with extensible 'Riplight System II'[®] patented waves.

- 2 x Fall arrester anchorage points (back - front)
- 4 x Adjustable buckles

Part No.	Qty	Description	Size
WS474	1	Fall Arrester Harness	L



DELTA PLUS 'Classic' Fall Arrester Kit

Approved to EN355:2002 / EN361:2002 / EN363:2008 / EN364:1992 / EN365:2004.
Ready for use fall arrester kit:

- 2 fall arrester anchorage point harness (back - front).
- 2 x Adjustment loops
- 2 x Adjustable side plates
- 1 x Screw Karabiner

Part No.	Qty	Description	Size
WS471	1 Kit	Fall Arrester Kit	L

1 x Fall arrest with non removable energy absorber in stranded rope dia. 12mm, length 2 m.

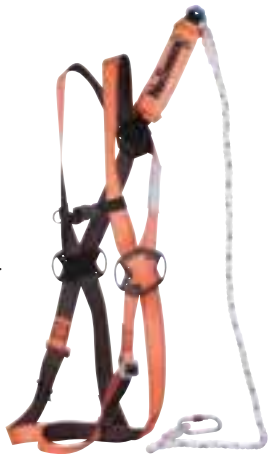

DELTA PLUS Energy Absorber Lanyard

Approved to EN363:2008 / EN364:1992 / EN365:2004 / EN355:2002.
Fall arrester with energy absorber in woven webbing with integrated crumple on the lanyard.

- Retracted length: 1.40 m. Stretched length: 2 m
- 1 x Screw lock karabiner in galvanized steel, opening 17 mm
- 1 x Automatic hook lock in galvanized steel, large opening 55 mm

Part No.	Qty	Description
WS475	1	Energy Absorber Lanyard



DELTA PLUS 'Scaffolding' Fall Arrester Kit

Approved to EN355:2002 / EN361:2002 / EN362:2004 / EN363:2008 / EN364:1992 / EN365:2004.

Ready for use fall arrester kit:
2 fall arrester anchorage point harness (back - front).

- 2 x Adjustment loops
- 2 x Adjustable side plates

Part No.	Qty	Description	Size
WS470	1 Kit	Fall Arrester Kit	L

Fall arrest with energy absorber with lanyard strap, length 2 m, equipped with 1 connector and 1 hook.



DELTA PLUS Lanyard

Approved to EN363:2008 / EN364:1992 / EN365:2004 / EN358:2002.

- Adjustable work positioning lanyard via reducer
- Protective sheath on the splices

Part No.	Qty	Rope Ø x Length
WS476	1	12 mm x 2 m



DELTA PLUS Screw Karabiner

Galvanized steel. Approved to EN362:2004 / EN363:2008 / EN364:1992 / EN365:2004. R > 23 kN.
Set of 5 screw lock karabiners in galvanized steel.

- Automatic locking mechanism
- Large eye opening

Part No.	Qty	Opening
WS477	5	17 mm



DELTA PLUS Fall Arrester Harness

Approved to EN361:2002 / EN363:2008 / EN364:1992 / EN365:2004 / EN355:2002 / EN361:2002

- 2 x Fall arrester anchorage point harness (back - front)
- 2 x Adjustment loops
- 2 x Adjustable lateral plates

Part No.	Qty	Description	Size
WS473	1	Fall Arrester Harness	L



DELTA PLUS Automatic Lock Hook

Approved to EN362:2004 / EN363:2008 / EN364:1992 / EN365:2004
Set of 2 automatic hooks lock in galvanized steel.

- Large opening 55 mm
- Eye hook. R > 20 kN.

Part No.	Qty	Description
WS478	2	Lock Hook





390



391



394



396



398



400



Welding, Gas + Abrasives



401

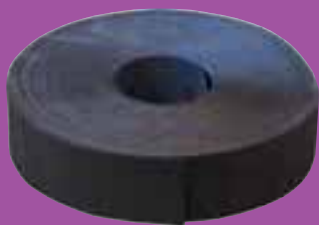

402

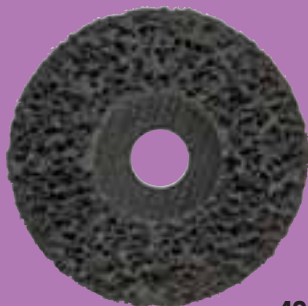

405

- 390 Welding Protection
- 391 Welding Rods
- 391 Welding Electrodes
- 392 Welding Accessories
- 394 Soldering
- 396 Gas Heating Spares
- 398 Gas Brazing
- 399 Grinding Wheels
- 399 Abrasive Rolls
- 400 Wire Wheels
- 401 Wire Brushes
- 402 Abrasive Rolls
- 402 Abrasive Paper
- 403 Sanding Blocks
- 404 Abrasive Discs
- 406 Abrasive Flap Discs
- 407 Polishing Discs
- 408 Cut-Off Discs
- 408 Thin Cutting Discs
- 409 Flat Cutting Discs
- 410 Depressed Centre Cutting Discs
- 411 Grinding Discs
- 412 Hand Files
- 413 Rotary Burrs
- 414 Aerosol Spray Packs



406



407



408



409



409



412



413





Welders' Face Shield - Hand Held Type

EN 175. Aperture.



Part No.	Qty	Takes Lens Size
WS22	1	4 1/4" x 3 1/4" (108 x 82.5 mm)

Welders' Face Shields

Complete with headband and fixed lens holder (Lens NOT included).



Part No.	Qty	Takes Lens Size
WS36	1	4 1/4" x 3 1/4" (108 x 82.5 mm)

Welders' Face Shields

Complete with headband and flip-up lens holder (Lens NOT included).



Part No.	Qty	Takes Lens Size
WS37	1	4 1/4" x 2" (108 x 51.0 mm)

Face Shield Lenses - 4 1/4" x 2"

DIN 0196CE where applicable. (108 x 51 mm).



Part No.	Pack of	Lens Type
WS22C	5	Anti-Spatter
WS22S	5	Shade No. 10

Face Shield Lenses - 4 1/4" x 3 1/4"

DIN 0196CE where applicable. (108 x 82.5 mm).



Part No.	Pack of	Lens Type
WS22CA	5	Anti-Spatter
WS22SA	5	Shade No. 10

Welding Goggles

One-piece. Spatter resistant lenses incorporating a gas welding filter for gas welding only. BS 679/1959.



Part No.	Qty	Lens Colour
WS4	1	Shade 5

Welding Goggles - Flip-Up Type

Flexible body with 50 mm round polycarbonate lenses and indirect vents for gas welding only. KM348551F.



Part No.	Qty	Lens Colour
WS16	1	Shade 5

Wide Vision Welding Goggles

CE marked. 99.9% UV/B protection. EN166 / EN171 / EN175.

Fits over most spectacles. Anti scratch/mist.



Part No.	Qty	Lens Colour	Markings
WS1511	1	Shade 5	4-5 1 BT 9 0

Wraparound Safety Spectacles with Rubber Nose Pads

CE marked. 99.9% UV/B protection.

EN166 / EN170 (*EN172) (†EN171).

Comfortable lightweight design, rubber nose pads and soft temple tips. Anti scratch.



Part No.	Qty	Lens Colour	Markings
WS1500	1	Shade 5 †	4-5 1 FT 0

Gauntlets

With tough cotton fleece lining, 5" cuffs. Colour may vary.



Part No.	Qty	Description	EN388 Rating
WS8	1 Pair	Gauntlets	4133





'Super 6' General Purpose Welding Electrodes

AWS: E6013 EN ISO 2560: E420 RC11.

Universal electrode for welding in all positions on AC and DC (AC>70V). Especially suitable for where one single type of electrode is required. General purpose electrode for welding high tensile steels and low alloy steel.

The weld metal shows an excellent low temperature toughness and high crack resistance. Applications: General fabrication, repair & maintenance.

Part No.	Weight	Size
WR51	5 kg	2.0 x 350 mm
WR52	5 kg	2.5 x 350 mm
WR53	5 kg	3.2 x 350 mm
WR54	5 kg	4.0 x 350 mm



HILCO 'Red Extra' Welding Electrodes

Steels, General Rutile.

AWS: E6013 DIN: E 51 32 R(C)3.

- Suitable for general purpose electrode, including thin sheet work.
- Easy striking, even on transformers with a low open circuit voltage.

Part No.	Qty	Ø	Weight
WR41	1	2.0 mm	4.1k g
WR42	1	2.5 mm	5.0 kg
WR43	1	3.2 mm	5.0 kg
WR44	1	4.0 mm	5.0 kg



Welding Curtain Set

Flame retardant to EN 1598. Dimensions: 6 x 6 ft.

Galvanised steel box section for enhanced strength.

Set contains: 1 x Metal Frame, 1 x PVC Green Curtain: 6 x 6 ft, 20 x Curtain Rings.

- Suitable for all types of welding: MIG, TIG, stick, oxy/fuel and plasma cutting
- Lightweight and portable
- Quick and easy to erect

Part No.	Qty	Description
WS500	1 Set	Welding Curtain Set
WS501	1	Replacement PVC Green Curtain
WS502	1	Replacement Metal Frame
WS503	20	Replacement Curtain Rings

sif



SIF 'Sifsteel No. 11' Welding Rods

Steel. Low carbon copper coated mild steel. BS 1453 A1.

For all classes of mild steel and wrought iron.

Part No.	Weight	Size	Equiv
WR1	2.5 kg	1.6 mm	1/16"
WR2	2.5 kg	2.4 mm	3/32"
WR3	2.5 kg	3.2 mm	1/8"

sif



SIF 'Sifredicote' Brazing Rods - Flux Coated

BS EN ISO 17672:2016 CU 470. A 'Sifbronze' No. 1 with a full flux coating.

- Provides a faster continuous brazing through not having to flux-dip.
- Ideal for general mild steel work, galvanised steel and dissimilar metal applications.

Part No.	Weight	Size	Equiv
WR82	1 kg	2.4 mm	3/32"
WR83	1 kg	3.2 mm	1/8"

sif



SIF 'Sifbronze No. 1' Brazing Rods

Non-impregnated. BS 1845 CZ6 / BS 1453 C2.

Part No.	Weight	Size	Equiv
WR11	1 kg	1.6 mm	1/16"
WR12	1 kg	2.4 mm	3/32"
WR13	1 kg	3.2 mm	1/8"

sif



SIF Brazing Flux

Part No.	Qty	Size
WRF3	1	225g Tub



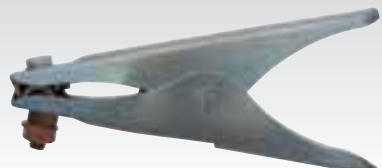

Earthing Clamp

Part No.	Qty	Amperage
WS72	1	400 A



Electrode Holder

Twist type.

Part No.	Qty	Amperage
WS74	1	400 A

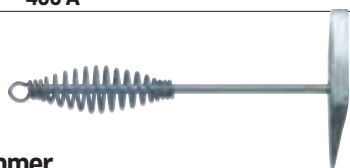

Chipping Hammer

Sprung handle.

Part No.	Qty	Description
WS70	1	Chipping Hammer



Spanner/Cylinder Keys

Part No.	Pack of	Description
WS13A	1	Spanner/Cylinder Key
WS13	2	Spanner/Cylinder Keys



Welding Nozzle Cleaners

Part No.	Pack of	Description
WS14A	1	Nozzle Cleaners
WS14	5	Nozzle Cleaners



Mig Wire

Copper coated deoxidised steel for semi-automatic welding (CO2 wire). BS 2901 A18.

Part No.	Qty	Diameter
WR73	5 kg Spool	0.6 mm
WR75	15 kg Spool	0.6 mm
WR74	5 kg Spool	0.8 mm
WR76	15 kg Spool	0.8 mm

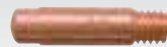

Torch Spares for Mig No. 15 Type Torches

Part No.	Pack of	Size
WS84	10	Tips 0.6 mm
WS85	10	Tips 0.8 mm



BEST SELLER

Torch Spares for Mig No. 15 Type Torches

Part No.	Pack of	Description
WS86	2	Shrouds



Torch Spares for Mig No. 25 Type Torches

Part No.	Pack of	Size
WS89	10	Tips 0.6 mm
WS90	10	Tips 0.8 mm



Torch Spares for Mig No. 25 Type Torches

Part No.	Pack of	Description
WS91	2	Shrouds



Torch Spares for Mig No. 25 Type Torches

Part No.	Pack of	Description
WS92	2	Tip Adaptor



Welding Nozzles

Swaged copper tube. Lightweight.

Part No.	Pack of	Size No.
WS9	3	No. 2
WS10	3	No. 3
WS11	3	No. 5
WS53	3	No. 10

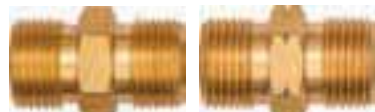

Male Fitting/Coupler

Suits fuel gases.

Part No.	Qty	Thread
GAS26	1	3/8" Left Hand
GAS25	1	3/8" Right Hand



Gas Cutting Nozzles - Acetylene

A-NMS. Suits 18/90 style torch.

Part No.	Qty	Size
WS60	1	1/32"
WS61	1	3/64"
WS62	1	1/16"



Gas Cutting Nozzles - Propane

P-NMS. Suits 18/90 style torch.

Part No.	Qty	Size	Cutting Capability
WS64	1	1/32"	3 - 6 mm Plate
WS67	1	3/64"	5 - 12 mm Plate
WS63	1	1/16"	10 - 75 mm Plate
WS68	1	5/64"	70 - 100 mm Plate
WS66	1	3/32"	90 - 150 mm Plate
WS65	1	1/8"	140 - 300 mm Plate



Welding Cable Plug

BS EN 60974-12. A standard Dinse type plug.

Part No.	Pack of	Type/Cable Size
WCP25	1	10 - 25 mm ²
WCP50	1	35 - 50 mm ²



Welding Cable Socket

BS EN 60974-12. A standard Dinse type socket.

Part No.	Pack of	Type/Cable Size
WCS50	1	35 - 50 mm ²
WCS25	1	10 - 25 mm ²



Stud Welding Panel Pins

Copper coated pins for use with dent pulling stud welders.

Part No.	Pack of	Dia x Length
DRP1	500	2.0 x 50 mm

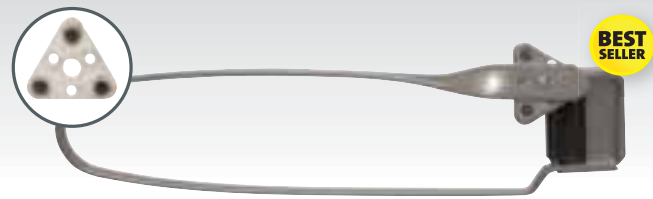

Triple Flint Lighter

Part No.	Qty	Description
WS54	1	Triple Flint Lighter



Triple Flints

Suits Part No. WS54.

Part No.	Pack of	Description
WS55	10	Triple Flints



Flint Lighter

Pistol type.

Part No.	Qty	Description
WS12	1	Flint Lighter



S-A-S Weld Anti-Spatter

Water Based

- Provides a protective oily film for use in welding
- Silicone FREE

Part No.	Pack of	Size
SAS9	6	400ml Aerosols



SIF Brazing Flux

Part No.	Qty	Size
WRF3	1	225g Tub





BEST SELLER

Solder Wire

Flux cored. 40% Tin / 60% Lead.
BS 441.

• General purpose.

Part No.	Qty	Diameter	
S02	0.5 kg Coil	1.6 mm Ø	(16 SWG)
S01	0.5 kg Coil	3.2 mm Ø	(10 SWG)



Solder

Tinmans. 40% Tin / 60% Lead.

Part No.	Pack of	Approx. Weight
S03	2 Sticks	0.5 kg



Solder Wire

Flux cored. 60% Tin / 40% Lead.
BS 441.

• For circuit boards, etc.

Part No.	Qty	Diameter	
S022	0.5 kg Coil	0.7 mm Ø	(22 SWG)
S018	0.5 kg Coil	1.2 mm Ø	(18 SWG)



Solder

Body solder. 28% Tin / 72% Lead.

Part No.	Pack of	Approx. Weight
S04	2 Sticks	1 kg



KS TOOLS Soldering Wire Holding Pliers

Special pliers for fixing wires during soldering.
Self closing spring and latching mechanism.

Part No.	Qty	Length
K115.1052	1	245 mm

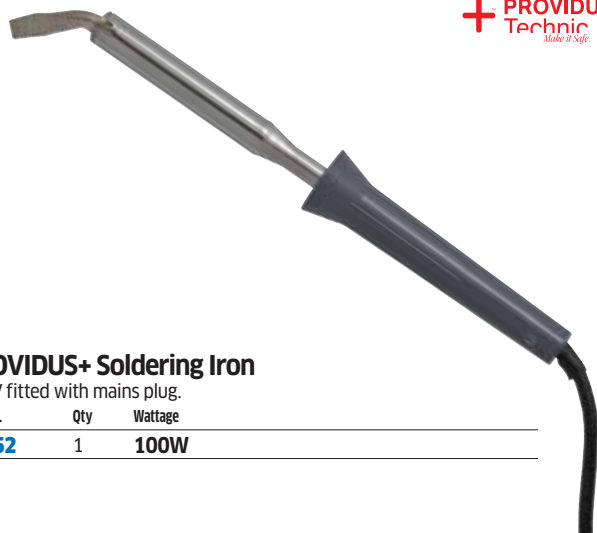

PROVIDUS+ Soldering Iron

230V fitted with mains plug.

Part No.	Qty	Wattage
TL952	1	100W

TEMPLER'S 'Telux' Soldering Flux

Milder formula. General purpose.
For copper pipe work, brass, mild steel and other metals.

Soft and easy to apply in a thin film,
e.g. capillary joints on pipe work.

NOT suitable for use on Aluminium or Stainless Steel.



Part No.	Qty	Size
S09	1	50g Tin
S08	1	250g Tub

Soldering Flux

Zinc chloride rosin free.

Part No.	Qty	Size
S06	1	500ml Bottle





KS TOOLS Micro Soldering Kit

Gas powered micro soldering equipment up to 1,300°C.
With Piezo ignition. Adjustable gas flow, refillable with gas lighter refills.
Supplied in robust storage case.

Part No.	Qty	Description
K960.1160	1 Set	10 Piece Set
1 x Gas soldering iron. 1 x Soldering head for screw-in soldering tips. 2 x Tips: 3.5 mm chisel tip, 4.5 mm diagonal tip. 1 x Heat-shrink tubing attachment. 1 x Cap Soldering. 1 x Solder wire spool. 1 x Cap. 1 x Tower housing. 1 x Soldering sponge.		



LASER Gas Soldering Kit

Part No.	Qty	Description
TL955	1 Set	5 Piece Set
1 x Torch with blow torch attachment. 2 x Soldering tips. 1 x Torch stand. 1 x Pack of solder.		



**Looking for Gas
Brazeing Torches & Gas?**

A full range can be found on Page 398



S-A-S Butane Gas Chargers

High quality, ultra pure butane gas.
Fitted with universal refill adaptor.

- Ideal for gas lighters, torches, gas soldering irons and glue guns.

Part No.	Pack of	Size
SAS50	6	200ml Aerosols



KS TOOLS Universal Butane Soldering Gun

Temperature up to 1300°C / 2450°F.
Flame soldering burner with small bundled flamer for fine soldering work.
Dimensions: 36 x 143 x 92 mm.
Complete with table stand.

Part No.	Qty	Description
K960.1200	1	Soldering Gun



LASER Butane Gas Solder Torch

Butane gas powered, hand held gas torch.
Suitable for heating and shrinking applications.

- Piezo electric ignition.
- Adjustable heat control.

Part No.	Qty	Description
TL7600	1	Butane Gas Torch



Windproof Jet Flame Torch

Refills with standard butane gas chargers (suits Part No. SAS50).
Colour/model may vary.

Part No.	Qty	Description
TL130	1	Jet Flame Torch





Butane Fixed Low Pressure 'Quick-On' Regulators - 28 Mbar

Conforms to EN 12864.
Outlet: For 10 mm Ø bore hose.



Part No.	Qty	Cylinder Diameter
GAS8	1	20 mm
GAS9	1	21 mm



Gas Hoses

BS3212: 1991/2/4,8. High pressure LPG.

Part No.	Qty	Dia x Length
GAS38	1	5 mm x 50 m Roll (3/16")
GAS39	1	6 mm x 50 m Roll (1/4")
GAS40	1	8 mm x 50 m Roll (5/16")



Gas Hose with 1/4" BSP Female Fittings

BS3212: 1991/2/4,8. High pressure LPG.

Part No.	Qty	Dia. x Length
GAS35	1	6 mm x 1.5 m (1/4")
GAS37	1	6 mm x 3.0 m (1/4")



Gas Hose with 1/4" BSP Female Fittings including 90° Fitting

BS3212: 1991/2/4,8. High pressure LPG.

Part No.	Qty	Dia x Length
GAS36	1	6 mm x 2 m Hose (1/4")



Locknuts For Thermocouples

Brass

Part No.	Pack of	Description
GAS63	20	Thermocouple Locknuts

Piezo Ignitor

Part No.	Qty	Description
GAS73	1	Piezo Ignitor



Thermostat Otterstat

Part No.	Qty	Description
GAS64	1	Thermostat Otterstat



Universal Electrode

Part No.	Qty	Description
GAS71	1	Electrode



Boxer Heater Flame Supervision Device

Mfr. Ref: SP 1400CN. Complete with locknuts.

Part No.	Qty	Description
GAS72	1	Heater Flame Device



BULLFINCH Boxer Heater Igniter & Lead

Mfr. Ref: SP 1400BD

Part No.	Qty	Description
GAS75	1	Heater Igniter & Lead



Boxer Heater Spark Plug

Mfr. Ref: SP 1500C.

Part No.	Qty	Description
GAS74	1	Heater Spark Plug

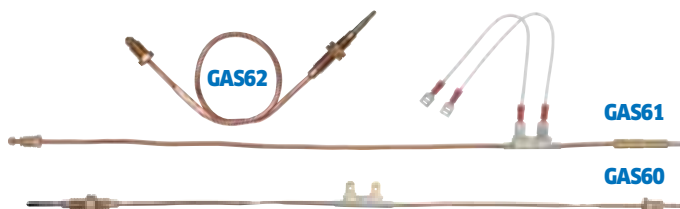

Thermocouples

Part No.	Qty	Description
GAS62	1	Boxer Heater Type
GAS61	1	300/350 (Unthreaded) (A)
GAS60	1	Threaded Type (E)





PROVIDUS+ Professional Turbo Torch

For use with GASEX® (VC51) gas cylinders. Particularly suited to both heating small parts and for small welding jobs. It can also be used for stripping paint, thawing piping, burning and brazing.

Part No.	Qty	Description
TL956	1	Professional Turbo Torch



PROVIDUS+ GASEX® Gas Cylinder

EN 471. TÜV approved.
• 35% faster than Propane.

Part No.	Qty	Size
VC51	1	860ml Cylinder



Soldering and Brazing Heat Mat

Made from HDW graphic, woven glass fibre. Dimensions: 250 mm x 250 mm (10" x 10"). For use with brazing torches, soldering irons, etc.

- Withstands temperatures up to 600°C.



Part No.	Qty	Description
WS19	1	Heat Mat

Ambersil

BEST SELLER



AMBERSIL Acrylic Paint Marker Pens

Tenacious resin binds paint to the writing surface almost eliminating the problems associated with accidental rub-off and will not wash off with water/rain.

Part No.	Qty	Colour	Nib Ø
AMB130	1	White	3 mm
AMB131	1	Yellow	3 mm
AMB132	1	Red	3 mm
AMB133	1	Black	3 mm



ARCTIC HAYES 'Vortex' Brazing Torch

Fits 1 inch CGA600 thread gas cylinders (suits Part No.s VG1 & VG2).

- Lightweight tough magnesium alloy body with soft rubber hand grip
- Piezo ignition, flame regulator and safety lock

Part No.	Qty	Description
VT1	1	Brazing Torch



BEST SELLER

ARCTIC HAYES 'Vortex' Map-X Gas

Suitable for all soldering and brazing applications.

- Burns up to +115°C.

Part No.	Qty	Size
VG1	1	400g Cylinder



ARCTIC HAYES 'Vortex' Propane Gas

Ideal for soldering fittings, etc.

- Burns up to 900°C+.

Part No.	Qty	Size
VG2	1	400g Cylinder



Grinding Wheels - A60 Fine

Aluminium oxide. 1 1/4" hole with reducing bushes for 1/2" axle.

Part No.	Qty	O.D. x Hole Ø	
WCD31	1	150 x 20 mm	(6" x 3/4")



Grinding Wheels - A46 Medium

Aluminium oxide. 1 1/4" hole with reducing bushes for 1/2" axle.

Part No.	Qty	O.D. x Hole Ø	
WCD32	1	150 x 20 mm	(6" x 3/4")



Grinding Wheels - A36 Coarse

Aluminium oxide. 1 1/4" hole with reducing bushes for 1/2" axle.

Part No.	Qty	O.D. x Hole Ø	
WCD33	1	150 x 20 mm	(6" x 3/4")



Grinding Wheels - 3C60 Silicon Carbide 60 Grit

NOT aluminium oxide. 1 1/4" hole with reducing bushes for 1/2" axle.

Part No.	Qty	O.D. x Hole Ø	
WCD34	1	150 x 20 mm	(6" x 3/4")



Steel Wool

Quality steel wool.

Part No.	Weight	Grade
WB26	1 lb (0.45 kg) Approx.	Fine Grade
WB28	1 lb (0.45 kg) Approx.	Medium Grade



Non-Woven Material Rolls - Aluminium Oxide

100 mm wide x 10 m roll.

Part No.	Qty	Colour	Grade
WB220	1	Red	Very Fine



Non-Woven Material Rolls - Silicon Carbide

100 mm wide x 10 m roll.

Part No.	Qty	Colour	Grade
WB210	1	Grey	Ultra Fine



Finishing Pads - Fibre

Dimensions: 152 x 229 mm

Part No.	Pack of	Colour	Grade
WB21	10	Grey	Ultra Fine
WB22	10	Red	Very Fine
WB23	10	Green	General Purpose





Cup Brushes - Twist Knot

Hardened steel wire.

Part No.	Qty	O.D. x Wire Ø	Size	Max RPM
WB55	1	70 mm x 0.35 mm	M10	14,000
WB60	1	70 mm x 0.35 mm	M10 x 1.25	14,000
WB56	1	70 mm x 0.35 mm	M14	14,000
WB57	1	85 mm x 0.50 mm	M14	8,500
WB59	1	105 mm x 0.50 mm	M14	8,500



Cup Brush

0.30 mm high resistance crimped steel wire.

Part No.	Qty	O.D.	Size	Max RPM
WB54	1	120 mm	M14	8,500



Wheel Brush - Twist Knot

0.50 mm Ø twist knot hardened steel wire.

Part No.	Qty	O.D.	Size	Max RPM
WB67	1	115 mm	M14	20,000



Conical Brushes - Twist Knot

0.50 mm Ø twist knot hardened steel wire.

Part No.	Qty	O.D.	Size	Max RPM
WB69	1	95 mm	M10	14,000
WB68	1	95 mm	M14	14,000



BEST SELLER

Shaft Mounted Cup Brushes

6 mm Ø Shaft. 0.35 mm Ø high resistance crimped steel wire.

Part No.	Qty	O.D.	Max RPM
WB61	1	50 mm	4,500
WB62	1	75 mm	4,500

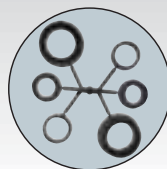

Wire Brushes with Metric Adaptors

0.35 mm Ø high resistance crimped steel wire.

Suitable for use with bench grinders.

Supplied with reducing adaptor kit for 16 mm, 20 mm, 25 mm bore hole.

Part No.	Qty	O.D. x Width	Bore Hole	Max RPM
WB49	1	150 x 20 mm	38 mm	6,000
WB50	1	200 x 29 mm	38 mm	6,000

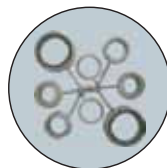

Wire Brushes with Imperial Adaptors

0.35 mm Ø high resistance crimped steel wire.

Suitable for use with bench grinders.

Supplied with reducing adaptor kit for 1/2", 5/8", 3/4", 1" bore hole.

Part No.	Qty	O.D. x Width	Bore Hole	Max RPM
WB51	1	200 x 23 mm	38 mm	6,000



NEW



BEST SELLER

Shaft Mounted Brush

0.30 mm Ø high resistance crimped steel wire.

Part No.	Qty	O.D.	Max RPM
WB66	1	20 mm	18,000



BEST SELLER

Shaft Mounted Wheel Brushes

6 mm Ø Shaft. 0.30 mm Ø high resistance crimped steel wire.

Part No.	Qty	O.D. x Width	Max RPM
WB64	1	50 x 8 mm	5,000
WB65	1	60 x 8 mm	6,000

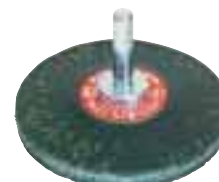

Rubber-Bonded Circular Shaft Brush (Mule Skinner)

6 mm Ø Shaft. 0.30 mm Ø brass coated steel wire.

Part No.	Qty	O.D.	Max RPM
WB70	1	60 mm	18,000





SIT 'SPID' Brushes

Part No.	Qty	Wire Type
WB19A	6	Brass Plated Steel
WB19	24	Brass Plated Steel



SIT 'SPID' Brushes

Part No.	Qty	Wire Type
WB31	6	Stainless Steel



LASER Wire Brush Set

A comprehensive wire brush set suitable for numerous uses including removing carbon from internal threads or pipes and cleaning drilled holes.

- The set includes a 6" extension with 1/4" shank quick release chuck for power tool use
- Soft grip handle for hand use

Part No.	Qty	Description
TL7120	1 Set	20 Piece Set

1 x Soft grip handle. 1 x 1/4" Shank quick release chuck: 6". 6 x Stainless steel brushes: 9, 10, 13, 15, 17, 19 mm.
6 x Brass brushes: 9, 10, 13, 15, 17, 19 mm. 6 x Nylon brushes: 9, 10, 13, 15, 17, 19 mm.



KS TOOLS Rubber Eraser Pad

(Toffee/Carmel Wheel). M8 shaft, for use in drills and cordless power tools (NOT suitable for air sanders).

- For complete and careful removal of pinstripes and adhesive wheel balance stickers on high value alloy wheels
- The neutral coloured rubber eraser pad ensures optimal results and prevents surface smudging

Part No.	Qty	Ø x Width	Max RPM
K515.1243	1	90 mm x 15 mm	2,000



Wire Brushes

Wooden handles.

Part No.	Pack of	Type
WB10A	6	2-Row
WB10	12	2-Row



Wire Brushes

Wooden handles.

Part No.	Pack of	Type
WB1A	6	4-Row
WB1	12	4-Row



Wire Brushes with Metal Scraper

Wooden handles.

Part No.	Qty	Type
WBS3	3	4-Row with Scraper
WBS1	1	4-Row with Scraper



Mini 3-Row Wire Brushes Set

Part No.	Qty	Description
WB30	1 Set	3 Piece Set

1 x Steel (Brush Head W x D): 90 x 20 mm. 2 x Brass (Brush Head W x D): 35 x 10, 90 x 20 mm.



Parts Cleaning Brush

Taper cut 64 mm pure bristles. Can be used in all parts cleaning solvents.

Part No.	Qty	Length
TNH266C	1	260 mm (10")





Emery Rolls - Blue Twill

Part No.	Length	Width	Grit
WER150	25 m Roll	25 mm (1")	150
WER80	25 m Roll	25 mm (1")	80
WER60	25 m Roll	25 mm (1")	60
WER40	25 m Roll	25 mm (1")	40

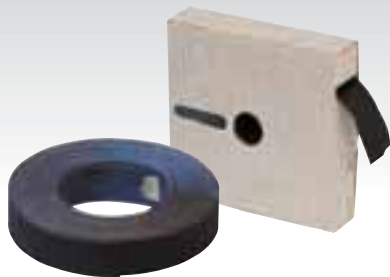

Emery Rolls - Blue Twill

Part No.	Length	Width	Grit
WER1	50 m Roll	25 mm (1")	150
WER10	50 m Roll	25 mm (1")	120
WER2	50 m Roll	25 mm (1")	80
WER25	50 m Roll	25 mm (1")	60
WER3	50 m Roll	25 mm (1")	40

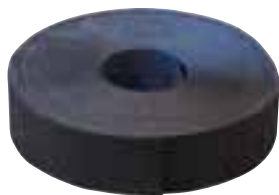

Emery Rolls - Blue Twill

Part No.	Length	Width	Grit
WER30	50 m Roll	50 mm (2")	80
WER31	50 m Roll	50 mm (2")	40



Emery Rolls - Brown (Engineers' Quality)

Part No.	Length	Width	Grit
WER6	50 m Roll	25 mm (1")	120
WER4	50 m Roll	25 mm (1")	80



Emery Rolls - Brown (Engineers' Quality)

Part No.	Length	Width	Grit
WER7	50 m Roll	50 mm (2")	120
WER5	50 m Roll	50 mm (2")	80

Emery Sheets - Blue Twill

Dimensions: 230 x 280 mm (9" x 11").

Part No.	Pack of	Grit
WES1	25	150
WES21	25	120
WES2	25	80
WES31	25	60
WES3	25	40



Production Papers - Aluminium Oxide

Sheet dimensions: 230 x 280 mm (9" x 11").

Part No.	Pack of	Grit
WPP1	25	80
WPP2	25	60
WPP3	25	40



Wet & Dry Papers

Sheet dimensions: 230 x 280 mm (9" x 11").

Part No.	Pack of	Grit
WAP7	25	1200
WAP6	25	1000
WAP800	25	800
WAP1	25	600
WAP2	25	400
WAP360	25	360
WAP3	25	320
WAP240	25	240
WAP4	25	180
WAP120	25	120
WAP5	25	80



KS TOOLS Sanding Block

Sponge rubber backing, stainless steel clamping clips.

- For use with emery, wet & dry, sand paper, etc.
- Very good for working on surfaces
- Moulded handle ensures a comfortable grip

Part No.	Qty	Description
K515.3095	1	Sanding Block



BIBIELLE Zirconium Sanding Belts

Polyester cloth with tape joint.

Part No.	Pack of	Ø	Grit
WSB31	10	13 x 305 mm	80
WSB32	10	13 x 305 mm	60
WSB33	10	13 x 305 mm	36
WSB51	10	19 x 520 mm	80
WSB52	10	19 x 520 mm	60
WSB53	10	19 x 520 mm	36

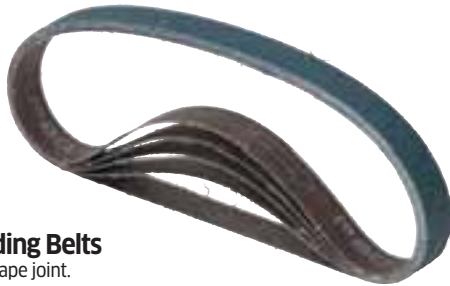

BIBIELLE Flap Wheels

Aluminium oxide cloth, 6 mm shaft.

Part No.	Pack of	Ø x Thickness	Grit
WAF216	4	25 mm x 10 mm	60
WAF218	4	25 mm x 10 mm	80
WAF226	4	25 mm x 20 mm	60
WAF228	4	25 mm x 20 mm	80
WAF424	4	40 mm x 20 mm	40
WAF426	4	40 mm x 20 mm	60
WAF428	4	40 mm x 20 mm	80
WAF434	4	40 mm x 30 mm	40
WAF436	4	40 mm x 30 mm	60
WAF438	4	40 mm x 30 mm	80
WAF524	4	50 mm x 25 mm	40
WAF526	4	50 mm x 25 mm	60
WAF528	4	50 mm x 25 mm	80
WAF624	4	60 mm x 30 mm	40
WAF626	4	60 mm x 30 mm	60
WAF628	4	60 mm x 30 mm	80
WAF854	2	80 mm x 50 mm	40
WAF856	2	80 mm x 50 mm	60
WAF858	2	80 mm x 50 mm	80



Sanding Block - Dense Red Rubber

Dense rubber sanding block fitted with slots to attach the abrasive paper.

- Can be used with wet or dry sanding

Part No.	Qty	Size
WSD102	1	70 x 125 mm



Sanding Kit - Curved Blocks

Includes both concave and convex adaptors. Takes standard 150 mm diameter hook and loop abrasive discs. Supplied in a robust storage case.

- Ideal for body contours and excellent for wheel arches, wings.
- Teardrop sander included, great for sanding grooves.

Part No.	Qty	Description
WSD100	6 Piece Set	Sanding Kit

Kit contains: 1 x Sanding wedge. 5 x Sanding blocks: Various shapes.



Sanding Block - Hook & Loop

Soft foam hand sanding block with a hook and loop backing. Takes standard 150 mm diameter hook and loop abrasive discs.

Part No.	Qty	Takes
WSD101	1	150 mm Ø Discs



Sanding Block with Dust Extraction

Hook and loop fitting. Dust extraction outlet 19 mm (external), supplied with 2 adaptors to allow a wide range of extraction systems to be connected (Adaptors: 25 mm and 28 mm).

- Dust extraction facility that can be coupled to a central vacuum unit for dust free sanding.
- Multiple hole configurations to accept a wide range of manufacturers abrasive sheets.

Part No.	Qty	Size
WSD103	1	70 x 420 mm





Backing Pads for Fibre-Backed Discs

ISO 15636

Part No.	Qty	Diameter	Size x Pitch	Max RPM
WSD61	1	90 mm	M10 x 1.50 mm	15,300
WSD62	1	102 mm	M14 x 2.00 mm	13,300
WSD63	1	178 mm	M14 x 2.00 mm	8,600



Sanding Discs - Fibre-Backed

Vulcanised.

Part No.	Pack of	Ø	Grit
WSD1	25	100 mm (4")	50
WSD2	25	100 mm (4")	36
WSD3	25	100 mm (4")	24
WSD31	25	115 mm (4 1/2")	50
WSD32	25	115 mm (4 1/2")	36
WSD33	25	115 mm (4 1/2")	24
WSD34	25	180 mm (7")	50
WSD35	25	180 mm (7")	36
WSD36	25	180 mm (7")	24



Sanding Discs - Self-Adhesive

150 mm (6") Ø

Part No.	Pack of	Ø	Grit
WSD7	100	150 mm (6")	320
WSD8	100	150 mm (6")	180
WSD81	100	150 mm (6")	120
WSD9	100	150 mm (6")	80
WSD91	100	150 mm (6")	40

Assorted Pack of 'Mini' Sanding Discs with Velour Backing c/w Backing Pad

Part No.	Description
AP70	51 Piece Set
10 x 50 mm (2") Discs: 60, 120, 240, 320, 400 Grit. 1 x Backing Pad: 50 mm (2").	

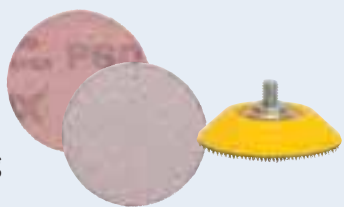

Backing Pads for Velour-Backed Discs

Part No.	Qty	Diameter	Size x Pitch
WSD60	1	150 mm	M14 x 2.00 mm



Sanding Discs with Velour Backing

Universal. For paint, metals, wood and lacquers. Spec KE-RR.

Part No.	Pack of	Ø	Grit
WSD41	100	150 mm (6")	120
WSD42	100	150 mm (6")	80
WSD43	100	150 mm (6")	60
WSD44	100	150 mm (6")	40

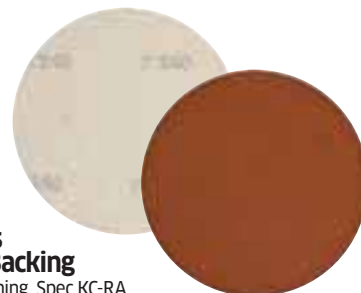

Sanding Discs with Velour Backing

Finer grits for finishing. Spec KC-RA.

Part No.	Pack of	Ø	Grit
WSD51	100	150 mm (6")	240
WSD52	100	150 mm (6")	180



'Mini' Sanding Discs with Velour Backing

Universal. For paint, metals, wood and lacquers. Spec KE-RR.

Part No.	Pack of	Ø	Grit
WSD70	10	50 mm (2")	60
WSD71	10	50 mm (2")	120
WSD72	10	50 mm (2")	240
WSD73	10	50 mm (2")	320
WSD74	10	50 mm (2")	400



Backing Pads for 'Mini' Fibre-Backed Discs

Part No.	Qty	Diameter	Shaft Size x Pitch
WSD64	1	50 mm (2")	6 x 1.00 mm
WSD65	1	75 mm (3")	6 x 1.00 mm



BIBIELLE Quick Change 'R' Holders

Medium (80 SHA) hardness.

Part No.	Qty	Diameter	Shaft Ø
WQD51	1	51 mm (2")	6 mm
WQD76	1	76 mm (3")	6 mm



BIBIELLE Quick Change 'R' Aluminium Oxide Discs

Max RPM: 25,000 (51 mm) & 20,000 (76 mm). Y-weight backing.

- Work surfaces: Standard steel and non-ferrous materials.

Part No.	Pack of	Diameter	Grit
WQD112	10	51 mm (2")	120
WQD108	10	51 mm (2")	80
WQD106	10	51 mm (2")	60
WQD103	10	51 mm (2")	36
WQD122	10	76 mm (3")	120
WQD118	10	76 mm (3")	80
WQD116	10	76 mm (3")	60
WQD113	10	76 mm (3")	36



BIBIELLE Quick Change 'R' High Performance Zirconium Discs

Max RPM: 25,000 (51 mm) & 20,000 (76 mm). Y-weight backing.

- Work surfaces: Standard steel, alloyed steel and non-ferrous materials.

Part No.	Pack of	Diameter	Grit
WQD132	10	51 mm (2")	120
WQD128	10	51 mm (2")	80
WQD126	10	51 mm (2")	60
WQD123	10	51 mm (2")	36
WQD142	10	76 mm (3")	120
WQD138	10	76 mm (3")	80
WQD136	10	76 mm (3")	60
WQD133	10	76 mm (3")	36

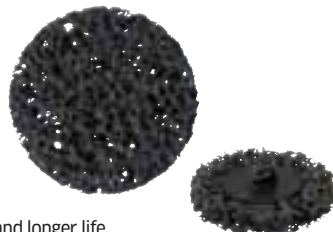

BIBIELLE Quick Change 'R' Surface Strip-It Discs

Rigid material with faster cuts and longer life.

Leaves a cleaning manageable surface to work on.

- Applications: Clearing welds, removing corrosion, rust, scale and paints.

Part No.	Pack of	Diameter	Max RPM
WQD170	2	51 mm (2")	10,500
WQD171	2	76 mm (3")	7,000



BIBIELLE Quick Change 'R' Surface Conditioning Discs

Max RPM: 22,100 (51 mm) & 15,100 (76 mm).

- Applications: deburring, cleaning, blending, finishing and polishing of a wide range of parts
- Suitable work surfaces: Any kind of metal (stainless steel, titanium, aluminium, alloys), plastic and composite

Part No.	Pack of	Diameter	Grade	Colour
WQD152	10	51 mm (2")	Fine	Blue
WQD151	10	51 mm (2")	Medium	Red
WQD150	10	51 mm (2")	Coarse	Brown
WQD162	10	76 mm (3")	Fine	Blue
WQD161	10	76 mm (3")	Medium	Red
WQD160	10	76 mm (3")	Course	Brown



BIBIELLE 'Strip-It' Abrasive Discs - Extra Coarse

Part No.	Pack of	O.D.	Thickness
WB107	2	178 mm (7")	13 mm



BIBIELLE Shafts for 'Strip-It' Discs

Part No.	Qty	Shaft	For Hole Sizes
WB608	1	6 mm	M8
WB612	1	6 mm	M12
WB812	1	8 mm	M12



BIBIELLE 'Strip-It' Abrasive Discs

Glass-backed. Extra coarse.

Part No.	Pack of	O.D.	Thickness
WB304	2	100 mm (4")	16 mm
WB3045	2	115 mm (4 1/2")	22 mm





OSBORN 'Special' Zirconium Flap Discs

Tapered type. Made of zirconium corundum. Compliant with EN 13743. For mild steel, stainless steel.

- For surface grinding on steel and stainless steel.
- No clogging up.
- Good grinding capacity.

Part No.	Pack of	O.D. x Hole Ø	Grit	Mx RPM
DFD1110	2	4 1/2" 115 x 22.23 mm	120	13,280
DFD118	2	4 1/2" 115 x 22.23 mm	80	13,280
DFD116	2	4 1/2" 115 x 22.23 mm	60	13,280
DFD116B	10	4 1/2" 115 x 22.23 mm	60	13,280
DFD114	2	4 1/2" 115 x 22.23 mm	40	13,280
DFD114A	5	4 1/2" 115 x 22.23 mm	40	13,280
DFD1210	2	5" 125 x 22.23 mm	120	12,200
DFD128	2	5" 125 x 22.23 mm	80	12,200
DFD126	2	5" 125 x 22.23 mm	60	12,200
DFD124	2	5" 125 x 22.23 mm	40	12,200



BIBIELLE Zirconium Flap Discs

Fibreglass backing. For deburring, removing welding seams and spots, removing scale, rust and oxidation of any kind, blunting sharp corners and edges.

Part No.	Pack of	O.D. x Hole Ø	Grit	Max RPM
WAF108	4	4" 100 x 16 mm	80	15,150
WAF106	4	4" 100 x 16 mm	60	15,150
WAF104	4	4" 100 x 16 mm	40	15,150
WAF118	4	4 1/2" 115 x 22.23 mm	80	13,300
WAF116	4	4 1/2" 115 x 22.23 mm	60	13,300
WAF114	4	4 1/2" 115 x 22.23 mm	40	13,300



OSBORN Polishing Flap Discs

For use with angle grinders. Compliant with EN 13743. Professionally de-rust and descale. Effective on stainless steel, steel, aluminium and non-ferrous metals.

Part No.	Pack of	O.D.	O.D. x Hole Ø	Grade Colour
DPD13	2	4 1/2"	115 x 22.23 mm	Fine Blue
DPD12	2	4 1/2"	115 x 22.23 mm	Medium Red
DPD11	2	4 1/2"	115 x 22.23 mm	Coarse Brown

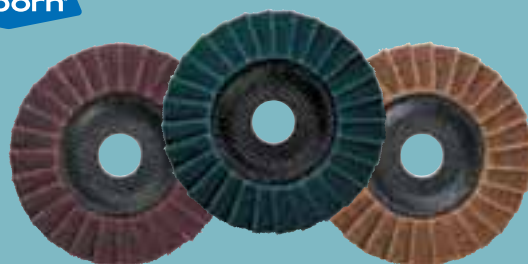

OSBORN Polishing Flap Discs

For use with angle grinders. Compliant with EN 13743. Professionally de-rust and descale. Effective on stainless steel, steel, aluminium and non-ferrous metals.

Part No.	Description
AP62	Assorted Pack of 3
1 x Coarse. 1 x Medium. 1 x Fine.	

DRONCO Are Rebranding To **osborn**

All DRONCO product labels will be rebranded under a new OSBORN design. The new designs will include clear user friendly information and pictograms whilst retaining the renowned DRONCO professional performance.



osborn



OSBORN Polishing Wheels

Soft fleece resin bonded on rigid plastic backing. For use with angle grinders. Suitable for corners, angles, U-profiles, on rounded or flat surfaces. Suitable for use on stainless steel, steel, aluminium and non-ferrous metals.

Part No.	Qty	O.D.	O.D. x Hole Ø	Grade
DPW21	1	4 1/2"	115 x 22.23 mm	Fine
DPW22	1	4 1/2"	115 x 22.23 mm	Medium
DPW31	1	5"	125 x 22.23 mm	Fine
DPW32	1	5"	125 x 22.23 mm	Medium



'Mini' Buffing Kit with Velour Backing c/w Backing Pad

Part No.	Qty	Description
WCS	1 Set	4 Piece Set

3 x 75 mm (3") Buffing Pads: Lambs wool, sponge pad (white), sponge pad (yellow).
1 x Backing Pad: 75 mm (3").

osborn



OSBORN Gloss Polishing Flap Discs

Fibreglass backing. Flaps are made of high quality special felt. Use for buffing and polishing components.

- Provides a mirror finish.

Part No.	Pack of	O.D.	O.D. x Thickness x Hole	Max RPM
DPD14	2	4 1/2"	115 x 1.0 x 22.23 mm	4,500

osborn



OSBORN Gloss Polishing Flap Disc Kit

Complete with polishing compounds. Ideal for stainless steel.

- Provides a mirror image.

Part No.	Description
AP75	5 Piece Kit

2 x Polishing Flap Discs G-VA: Coarse, Fine. 1 x Gloss Polishing Flap Disc G-VA finish.
2 x Polishing Compounds. 110g: Blue (for non-ferrous), White (for pre-polishing steel/stainless steel).

KS TOOLS
GERMANY



KS TOOLS Rubber Eraser Pad

(Toffee/Caramel Wheel). M8 shaft, for use in drills and cordless power tools (NOT suitable for air sanders).

- For complete and careful removal of pinstripes and adhesive wheel balance stickers on high value alloy wheels
- The neutral coloured rubber eraser pad ensures optimal results and prevents surface smudging

Part No.	Qty	Ø x Width	Max RPM
K515.1243	1	90 mm x 15 mm	2,000



Compounding Pad - European Foam

Size (Thickness x Dia): 50 x 150 mm. Thread: M14. Speed rating: 2.600 RPM.

Part No.	Qty	Colour	Type
WSD110	1	White	Hard
WSD111	1	Black	Soft/Medium





Cut-off Wheels

Resinoid. Double reinforced for safe operation at high speed. One mandrel for all sizes. For cut-off or slotting hard or ferrous metals. Use with high speed air guns (for best results and prolonged wheel life), 1/4" chuck or larger, or with electric drills and grinders.

Part No.	Pack of	O.D. x Thick x Hole Ø	Max RPM
WCD23	5	3" x 1/32" x 3/8"	76 x 0.8 x 10 mm 20,372
WCD24	5	3" x 1/16" x 3/8"	76 x 1.6 x 10 mm 20,372



OSBORN 'Special' Mini Metal Cutting Discs

Compliant with EN 12413. Small cutting disc for pneumatic grinders. Perfect for thin sheet steel. Good performance on construction steel, tool steel and high speed steel.

Part No.	Pack of	O.D. x Thickness	O.D. x Thickness x Hole Ø	Max RPM
DCD23	10	3" x 3/64"	76 x 1.2 x 10 mm	20,100
DCD24	10	3" x 5/64"	76 x 2.0 x 10 mm	20,100



BIBIELLE 1.0 mm Thin Cut-off Flat Metal Cutting Discs

Applications: Cutting sheet metals, pipes, box beams, sections and solid metal structures, bodyworks. Work surfaces: Standard steel, iron.

Part No.	Pack of	O.D.	O.D. x Thick x Hole Ø	Max RPM
WCD50	5	3"	76 x 1.0 x 10.0 mm	20,000



Cut-off Wheel Kit

For 1/4" and 3/8" (10 mm) holes. Fits 1/4" and 3/8" (10 mm) chuck.

Part No.	Qty	Description
WCD26	3 Pc Kit	Mandrel Kit

workshop warehouse



Workshop Warehouse 1 mm Thin Flat Cutting Disc

Manufactured in Europe. Compliant with EN 12413. Free from Fe, S or Cl. Designed specifically for special cutting applications where speed, efficiency and accuracy are all important. Typical applications: Cutting stainless steel, construction steel.

Part No.	Pack of	O.D.	O.D. x Thickness x Hole	Max RPM
WCD145/25	25	4 1/2"	115 x 1.0 x 22.23 mm	13,200



OSBORN '1 mm Inox Special' Flat Metal Cutting Discs

Compliant with EN 12413. Extremely fast cutting with minimum effort required. Precision cutting accurate to the millimetre. Low-burr giving burr-free edges. Ideal for sheet metal, steel cable, thin-walled profile sections, pipes of stainless steel and non-ferrous metals and composite materials (FRP).

Part No.	Pack of	O.D.	O.D. x Thickness x Hole Ø	Max RPM
DCD51	5	4 1/2"	115 x 1.0 x 22.23 mm	13,280
DCD51B	25	4 1/2"	115 x 1.0 x 22.23 mm	13,280
DCD52	5	5"	125 x 1.0 x 22.23 mm	12,200
DCD52B	25	5"	125 x 1.0 x 22.23 mm	12,200



OSBORN '1 mm Inox Special' Flat Metal Cutting Discs In 'Lifetime-Plus' Tins

Compliant with EN 12413. Extremely fast cutting with minimum effort required. Precision cutting accurate to the millimetre. Low-burr giving burr-free edges. Extreme cutting power and speed with ultra-long life for more cuts. Ideal for sheet metal, steel cable, thin-walled profile sections, pipes of stainless steel and non-ferrous metals and composite materials (FRP).

- Over 30% more service-life of cutting discs from a freshly opened 'Lifetime-Plus' pack!
- The "fresh from the oven" discs ensure to put all their power onto the machine.

Part No.	Qty	O.D.	O.D. x Thickness x Hole	Max RPM
DCLP51	Tin of 10 Discs	4 1/2"	115 x 1.0 x 22.23 mm	13,280
DCLP52	Tin of 10 Discs	5"	125 x 1.0 x 22.23 mm	12,200



OSBORN 'Jubilee 1 mm' High Performance Edition Cutting Discs

Supplied in a 'lifetime-plus' vacuum sealed tin. Extremely fast cutting with minimum effort required. Precision cutting accurate to the millimetre. Ideal for thin sheets, steel ropes, thin-walled profiles and pipes made of steel or stainless steel. Compliant with EN12413.

Part No.	Qty	O.D.	O.D. x Thickness x Hole	Max RPM
DCLP70	Tin of 10 Discs	4 1/2"	115 x 1.0 x 22.23 mm	13,280
DCLP71	Tin of 10 Discs	5"	125 x 1.0 x 22.23 mm	12,200



BEST SELLER

BIBIELLE 1.0 mm Thin Flat Metal Cutting Discs

Applications: Cutting sheet metals, pipes, box beams, sections and solid metal structures, bodyworks. Work surfaces: Standard steel, iron.

Part No.	Pack of	O.D.	O.D. x Thick x Hole Ø	Max RPM
WCD51	5	4 1/2"	115 x 1.0 x 22.2 mm	13,300
WCD52	5	5"	125 x 1.0 x 22.2 mm	12,200



BIBIELLE 1.2 mm Thin Flat Metal Cutting Discs

Applications: Cutting sheet metals, pipes, box beams, sections and solid metal structures, bodyworks. Work surfaces: Standard steel, iron.

Part No.	Pack of	O.D.	O.D. x Thick x Hole Ø	Max RPM
WCD81	5	4 1/2"	115 x 1.2 x 22.2 mm	13,300
WCD81B	50	4 1/2"	115 x 1.2 x 22.2 mm	13,300
WCD83	5	5"	125 x 1.2 x 22.2 mm	12,200



OSBORN '1.6 mm Inox Special' Flat Metal Cutting Discs

Compliant with EN 12413. For normal steel and stainless steel, particularly suitable for sheet metal and thin-walled profiles. High cutting speed. Long service life, hardly any burring. The standard disc used in tank farms and in tank construction.

Part No.	Pack of	O.D.	O.D. x Thickness x Hole Ø	Max RPM
DCD56	5	4 1/2"	115 x 1.6 x 22.23 mm	13,280
DCD56B	25	4 1/2"	115 x 1.6 x 22.23 mm	13,280



BIBIELLE 2.5 mm Thin Flat Metal Cutting Discs

Applications: Cutting sheet metals, pipes, box beams, sections and solid metal structures, Work surfaces: Standard steel, iron.

Part No.	Pack of	O.D.	O.D. x Thick x Hole Ø	Max RPM
WCD71	5	4"	100 x 2.5 x 16.0 mm	15,200
WCD73	5	4 1/2"	115 x 2.5 x 22.2 mm	13,300
WCD79	5	9"	230 x 2.5 x 22.2 mm	6,600



OSBORN 'Perfect' Flat Metal Cutting Discs

Compliant with EN 12413. All-purpose disc, suitable for cutting all types of metal. Good service life.

Part No.	Pack of	O.D.	O.D. x Thickness x Hole Ø	Max RPM
DCD31	5	4"	100 x 3.0 x 16.00 mm	15,250
DCD33	5	4 1/2"	115 x 3.0 x 22.23 mm	13,280
DCD35	5	5"	125 x 3.0 x 22.23 mm	12,200
DCD37	5	7"	180 x 3.0 x 22.23 mm	8,600
DCD39	5	9"	230 x 3.0 x 22.23 mm	6,600
DCD45	2	12"	300 x 3.5 x 20.00 mm	5,100
DCD46	2	14"	356 x 3.0 x 25.40 mm (Chop Saw Wheel)	4,400



workshop warehouse



Workshop Warehouse 3 mm Cutting Disc - Depressed Centre

Manufactured in Europe. Compliant with EN 12413.
Suitable for cutting all metals.

Part No.	Pack of	O.D.	O.D. x Thickness x Hole	Max RPM
WCD345/25	25	4 1/2"	115 x 3.0 x 22.23 mm	13,200



BIBIELLE Metal Cutting Discs - Depressed Centre

Applications: Cutting sheet metals, pipes, box beams, sections and solid metal structures, Work surfaces: Standard steel, iron.

Part No.	Pack of	Ø	O.D. x Thick x Hole Ø	Max RPM
WCD61	5	4"	100 x 3.0 x 16.0 mm	15,200
WCD61B	50	4"	100 x 3.0 x 16.0 mm	15,200
WCD63	5	4 1/2"	115 x 3.0 x 22.2 mm	13,300
WCD63B	50	4 1/2"	115 x 3.0 x 22.2 mm	13,300
WCD65	5	5"	125 x 3.0 x 22.2 mm	12,200
WCD67	5	7"	180 x 3.0 x 22.2 mm	8,500
WCD69	5	9"	230 x 3.0 x 22.2 mm	6,600
WCD69B	25	9"	230 x 3.0 x 22.2 mm	6,600

DRONCO Are Rebranding To **osborn**

All DRONCO product labels will be rebranded under a new OSBORN design. The new designs will include clear user friendly information and pictograms whilst retaining the renowned DRONCO professional performance.



osborn



OSBORN 'Perfect' Metal Cutting Discs - Depressed Centre

Compliant with EN 12413.

All-purpose disc, suitable for cutting all types of metal. Good service life.

Part No.	Pack of	O.D.	O.D. x Thickness x Hole Ø	Max RPM
DCD1	5	4"	100 x 3.0 x 16.00 mm	15,250
DCD1B	25	4"	100 x 3.0 x 16.00 mm	15,250
DCD3	5	4 1/2"	115 x 3.0 x 22.23 mm	13,280
DCD3B	25	4 1/2"	115 x 3.0 x 22.23 mm	13,280
DCD5	5	5"	125 x 3.0 x 22.23 mm	12,200
DCD7	5	7"	180 x 3.0 x 22.23 mm	8,600
DCD9	5	9"	230 x 3.0 x 22.23 mm	6,600
DCD9B	25	9"	230 x 3.0 x 22.23 mm	6,600

osborn



OSBORN 'Inox Special' Cut+Grind Discs - Depressed Centre

Compliant with EN 12413. Multipurpose disc for cutting and grinding. Suitable for thin and thick walled profiles and solid materials.

Part No.	Pack of	O.D.	O.D. x Thickness x Hole Ø	Max RPM
DCG1	5	4 1/2"	115 x 2.5 x 22.23 mm	13,280
DCG1B	25	4 1/2"	115 x 2.5 x 22.23 mm	13,280



Workshop Warehouse 6 mm Grinding Disc - Depressed Centre

Manufactured in Europe. Compliant with EN 12413.
Suitable for all grinding applications on all metals.

Part No.	Pack of	O.D.	O.D. x Thickness x Hole	Max RPM
WGD645/25	25	4 1/2"	115 x 6.0 x 22.23 mm	13,200



BIBIELLE Metal Grinding Discs - Depressed Centre

Designed for removing any metal material rapidly and efficiently.
Applications: Deburring, removing welding seams, working sharp edges.

Part No.	Pack of	O.D.	O.D. x Thick x Hole Ø	Max RPM
WCD62	5	4"	100 x 6.5 x 16.0 mm	15,200
WCD62B	50	4"	100 x 6.5 x 16.0 mm	15,200
WCD64	5	4 1/2"	115 x 6.5 x 22.2 mm	13,300
WCD64B	50	4 1/2"	115 x 6.5 x 22.2 mm	13,300
WCD66	5	5"	125 x 6.5 x 22.2 mm	12,200
WCD68	5	7"	178 x 6.5 x 22.2 mm	8,500
WCD70	5	9"	230 x 6.5 x 22.2 mm	6,600



SafeSaw System - Steel Set

Compatible with 115 mm angle grinders. Max speed: 19,000 RPM.
The SafeSaw System universal cutting blade will cut through most materials, including: Wood and wood with nails, aluminium, steel and iron up to 8 mm thick. Ideal for exhausts, studding and steel panels.

Part No.	Qty	Description
TL615	1 Set	SafeSaw System Set
TL616	1	Replacement 115 mm Steel Blade

1 x Safety Guard. 1 x Arbour Kit. 1 x Spanner. 1 x Steel Blade: 115 mm x 25.4 mm.

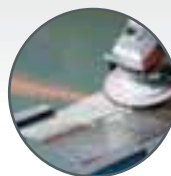

DRONCO 'Perfect' Metal Grinding Discs - Depressed Centre

Compliant with EN 12413.
For all types of metal, primarily sheet steel, construction steel and welding seams. Hard, all-purpose disc with a good service life.

Part No.	Pack of	O.D.	O.D. x Thickness x Hole Ø	Max RPM
DGD2	10	4"	100 x 6.0 x 16.00 mm	15,250
DGD4	10	4 1/2"	115 x 6.0 x 22.23 mm	13,280
DGD6	10	5"	125 x 6.0 x 22.23 mm	12,200
DGD8	5	7"	180 x 6.0 x 22.23 mm	8,600
DGD10	5	9"	230 x 6.0 x 22.23 mm	6,600



DRONCO 'Quality ST 7' Diamond Cutting Discs

Sintered, segmented diamond cutting disc.
Compliant with EN 13236. Dry cutting. C 3 shape 7 mm segments.

Suitable for cutting all kind of construction site materials:

- Concrete.
- Sand-lime Stone.
- Sand Stone.
- Porous Concrete.
- Lime Stone.
- Brick.
- Concrete Roofing Tiles.

Part No.	Qty	O.D.	O.D. x Thickness x Hole Ø	Segments Max RPM
DDB1	1	4 1/2"	115 x 2.0 x 22.23 mm	9 13,280
DDB2	1	5"	125 x 2.0 x 22.23 mm	9 12,200
DDB3	1	7"	180 x 2.2 x 22.23 mm	14 8,600
DDB4	1	9"	230 x 2.4 x 22.23 mm	18 6,600
DDB5	1	12"	300 x 3.2 x 20.00 mm	18 6,400
DDB6	1	12"	300 x 3.2 x 22.23 mm	22 6,400
DDB7	1	14"	350 x 3.2 x 25.40 mm	24 5,500





BAHCO Engineers' File Set

Complete with handles. Black finish heads. Supplied with roll-up plastic wallet & tie.

Part No.	Qty	Length	
TB47808	5 Piece Set	8"	(200 mm)
4 x Bastard Cut: Hand, Square, Half-round, Round. 1 x Second Cut: Hand.			



BAHCO Engineers' File Set

Complete with handles. Black finish heads. Supplied with roll-up plastic wallet & tie.

Part No.	Qty	Length	
TB47810	5 Piece Set	10"	(250 mm)
4 x Bastard Cut: Hand, Square, Half-round, Round. 1 x Bastard Cut: Hand.			



LASER Precision Needle File Set

Supplied in a storage wallet.

- Precision hardened and tempered files.
- Interchangeable soft grip handle.
- File lengths: 120 mm.

Part No.	Qty	Description
TL7112	1 Set	13 Piece Set
12 x Needle files: Various types. 1 x Interchangeable handle.		



File Handles

Wooden.

Part No.	Pack of
TL784	10 Pieces
3 x For Files: 6", 10". 4 x For Files: 8".	



File Set

WITHOUT handles. BS 498. Supplied in a telescopic plastic box.

Part No.	Qty	Description
TL751	1 Set	8 Piece Set
4 x Bastard Cut: Hand 10", Half-round 10", Round 10", Square 8".		
4 x Second Cut: Hand 8", Half-round 8", Round 6", Three-square 8".		



File Set - Second Cut

Complete with detachable ABS handles. BS 498. Supplied in a wallet.

Part No.	Qty	Description
TL766	1 Set	4 Piece Set
2 x Hand: 8". 1 x Half-Round: 8". 1 x Round: 8".		



Parts Cleaning Brush

Taper cut 64 mm pure bristles. Can be used in all parts cleaning solvents.

Part No.	Qty	Length
TNH266C	1	260 mm (10")



ALPEN Rotary Burr - Oval

Tungsten carbide. No. 6 Cut (Universal).
For soft and hard metals (weld seams).
Supplied in a plastic storage box.

Part No.	Qty	Head Ø	Length	Shaft Ø
DB22	1	6 mm	61 mm	6 mm
DB23	1	8 mm	61 mm	6 mm
DB4	1	10 mm	61 mm	6 mm
DB24	1	12 mm	61 mm	6 mm



ALPEN Rotary Burr - Arc Round Nose

Tungsten carbide. No. 6 Cut (Universal).
For soft and hard metals (weld seams).
Supplied in a plastic storage box.

Part No.	Qty	Head Ø	Length	Shaft Ø
DB19	1	6 mm	65 mm	6 mm
DB20	1	8 mm	65 mm	6 mm
DB5	1	10 mm	65 mm	6 mm
DB21	1	12 mm	65 mm	6 mm



ALPEN Rotary Burr - Arc Pointed Nose (Tree)

Tungsten carbide. No. 6 Cut (Universal).
For soft and hard metals (weld seams).
Supplied in a plastic storage box.

Part No.	Qty	Head Ø	Length	Shaft Ø
DB16	1	6 mm	65 mm	6 mm
DB17	1	8 mm	65 mm	6 mm
DB3	1	10 mm	65 mm	6 mm
DB18	1	12 mm	65 mm	6 mm



ALPEN Rotary Burr - Ball Nose

Tungsten carbide. No. 6 Cut (Universal).
For soft and hard metals (weld seams).
Supplied in a plastic storage box.

Part No.	Qty	Head Ø	Length	Shaft Ø
DB10	1	6 mm	65 mm	6 mm
DB11	1	8 mm	65 mm	6 mm
DB2	1	10 mm	65 mm	6 mm
DB12	1	12 mm	65 mm	6 mm



ALPEN Rotary Burr Set

Tungsten carbide. No. 6 Cut (Universal).
For soft and hard metals (weld seams).
Supplied in a plastic storage box.

Part No.	Qty	Description	Head Ø
DBK3	1 Set	3 Piece Set	10 mm

1 x Cylindrical with front cut.
1 x Arc pointed nose.
1 x Ball nose.



**BEST
SELLER**



ALPEN Rotary Burr - Cylindrical, Front End Cut

Tungsten carbide. No. 6 Cut (Universal).
For soft and hard metals (weld seams). Supplied in a plastic storage box.

Part No.	Qty	Head Ø	Length	Shaft Ø
DB7	1	6 mm	65 mm	6 mm
DB8	1	8 mm	65 mm	6 mm
DB1	1	10 mm	65 mm	6 mm
DB9	1	12 mm	65 mm	6 mm



ALPEN Rotary Burr - Conical Ball Nose

Tungsten carbide. No. 6 Cut (Universal).
For soft and hard metals (weld seams). Supplied in a plastic storage box.

Part No.	Qty	Head Ø	Length	Shaft Ø
DB13	1	6 mm	65 mm	6 mm
DB14	1	8 mm	65 mm	6 mm
DB6	1	10 mm	65 mm	6 mm
DB15	1	12 mm	65 mm	6 mm





SAS



S-A-S Assorted Pack - Lubricant Aerosols 500ml

A selection of our fastest moving lubricant aerosols, including the No. 1 selling Universal Maintenance Lubricant used for a multitude of lubricating and maintenance applications.

Part No.	Qty
SASL	Set of 6
6 x 500ml Aerosols: White Grease with PTFE, Clear Grease, Silicone Spray, Chain & Cable Lube, Copper Grease, Universal Maintenance Lubricant.	

SAS



S-A-S Assorted Pack - Cleaning Aerosols 500ml

A selection of popular cleaning aerosols, plus the No. 1 selling Universal Maintenance Lubricant which can be used for a wide range of everyday cleaning applications.

Part No.	Qty
SASC	Set of 6
6 x 500ml Aerosols: Brake Cleaner, Throttle Body Cleaner, Electrical Cleaner, Label & Gum Remover, Leak Detector, Universal Maintenance Lubricant.	

SAS



S-A-S Assorted Pack - Valeting Aerosols 500ml

A selection of professional quality valeting aerosols, providing a clean finish for all vehicles. Plus the No.1 selling Universal Maintenance Lubricant, ideal for everyday maintenance applications.

Part No.	Qty
SASP	Set of 6
6 x 500ml Aerosols: Glass Cleaner, Cockpit Spray, Tyre Foam, Multi Purpose Foam Cleaner, Air Duster, Universal Maintenance Lubricant.	

SAS



S-A-S Assorted Pack - Paint Aerosols 500ml

A selection of top quality paint aerosols, providing a professional finish each and every time. Plus the No. 1 selling Universal Maintenance Lubricant, ideal for everyday maintenance applications.

Part No.	Qty
SASP	Set of 6
6 x 500ml Aerosols: Zinc Spray, Satin Black Paint, Silver Paint, Grey Primer, Red Oxide Primer, Universal Maintenance Lubricant.	





416



417



418



419



420



421

Cutting + Drilling



422



423



423

- 416 Drills
- 420 Spot Weld Drills
- 421 Stub Drills
- 421 Step Drills
- 422 Drill Chucks
- 423 Taps + Dies
- 424 Hole Saws
- 425 Hacksaws + Blades
- 426 Saws + Blades
- 428 Scrapers
- 429 Knives + Blades
- 430 Snap-Off Knives
- 430 Scissors
- 431 Cutters
- 432 VDE Cutters + Pliers



424

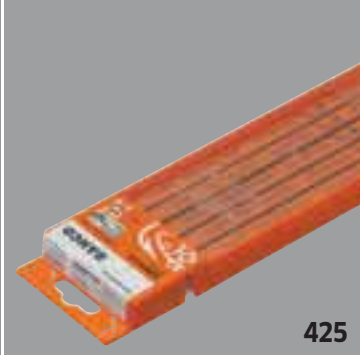

425



427



428



429



430



431



432





DORMER

DORMER 'A100' HSS Jobber Twist Drills - Metric

Steam tempered. 118° point angle. DIN 338.

Part No.	Pack of	Ø	Length
DHM1	10	1 mm	34 mm
DHM1.5	10	1.5 mm	40 mm
DHM2	10	2 mm	49 mm
DHM2.5	10	2.5 mm	57 mm
DHM3	10	3 mm	61 mm
DHM3.2	10	3.2 mm	65 mm
DHM3.3	10	3.3 mm	65 mm
DHM3.5	10	3.5 mm	70 mm
DHM4	10	4 mm	75 mm
DHM4.2	10	4.2 mm	75 mm
DHM4.5	10	4.5 mm	80 mm
DHM4.8	10	4.8 mm	86 mm
DHM4.9	10	4.9 mm	86 mm
DHM5	10	5 mm	86 mm
DHM5.5	10	5.5 mm	93 mm
DHM6	10	6 mm	93 mm
DHM6.5	10	6.5 mm	101 mm
DHM6.8	10	6.8 mm	109 mm
DHM7	10	7 mm	109 mm
DHM7.5	10	7.5 mm	109 mm
DHM8	10	8 mm	117 mm
DHM8.5	10	8.5 mm	117 mm
DHM9	10	9 mm	125 mm
DHM9.5	10	9.5 mm	125 mm
DHM10	10	10 mm	133 mm
DHM10.2	5	10.2 mm	133 mm
DHM10.5	5	10.5 mm	133 mm
DHM11	5	11 mm	142 mm
DHM11.5	5	11.5 mm	142 mm
DHM12	5	12 mm	151 mm
DHM12.5	5	12.5 mm	151 mm
DHM13	5	13 mm	151 mm



DORMER

DORMER 'A100' HSS Jobber Twist Drills - Imperial

Steam tempered. 118° point angle. DIN 338.

Part No.	Pack of	Ø	Length
DH116	10	1/16"	43 mm
DH1964	10	19/64"	117 mm
DH564	10	5/64"	49 mm
DH516	10	5/16"	117 mm
DH332	10	3/32"	57 mm
DH2164	10	21/64"	117 mm
DH764	10	7/64"	61 mm
DH1132	10	11/32"	125 mm
DH18	10	1/8"	65 mm
DH2364	10	23/64"	125 mm
DH964	10	9/64"	70 mm
DH38	10	3/8"	133 mm
DH532	10	5/32"	75 mm
DH2564	10	25/64"	133 mm
DH1164	10	11/64"	80 mm
DH1332	5	13/32"	133 mm
DH316	10	3/16"	86 mm
DH2764	5	27/64"	142 mm
DH1364	10	13/64"	86 mm
DH716	5	7/16"	142 mm
DH732	10	7/32"	93 mm
DH2964	5	29/64"	142 mm
DH1564	10	15/64"	93 mm
DH1532	5	15/32"	151 mm
DH14	10	1/4"	101 mm
DH3164	5	31/64"	151 mm
DH1764	10	17/64"	109 mm
DH12	5	1/2"	151 mm
DH932	10	9/32"	109 mm

DORMER

DORMER 'A100' HSS Jobber Twist Drill Set - Metric Set No. '419'

Steam tempered.
118° point angle.
DIN 338. Supplied in
a plastic selector box.

Part No.	Qty	Description
DHK19	1 Set	19 Piece Set

19 x Sizes: 1.0 - 10.0 mm in 0.5 mm steps.



DORMER



DORMER 'A100' HSS Jobber Twist Drill Set - Metric Set No. '204'

Steam tempered. 118° point angle.
DIN 338. Supplied in a metal storage box.

Part No.	Qty	Description
DHK25	1 Set	25 Piece Set

25 x Sizes: 1.0 - 13.0 mm in 0.5 mm steps.

SAS

S-A-S Cutting Oil

For all metal types.

- Improves lubrication/cooling.
- Retains viscosity at high cutting temperatures.
- Prevents tarnishing.
- Extends tool life.

Part No.	Pack of	Size
SAS46	6	500ml Aerosols



Assorted Pack of Plastic Wall Plugs

Part No.	Pack of
AP49	400 Pieces

3 x Colours: Yellow, Red, Brown.





ALPEN 'Sprint Master' HSS Jobber Twist Drills - Imperial

DIN 338.

Part No.	Qty	Ø
DR116	10	1/16"
DR564	10	5/64"
DR332	10	3/32"
DR764	10	7/64"
DR18	10	1/8"
DR18L	50	1/8"
DR964	10	9/64"
DR532	10	5/32"
DR1164	10	11/64"
DR316	10	3/16"
DR316L	50	3/16"
DR1364	10	13/64"
DR732	10	7/32"
DR1564	10	15/64"
DR14	10	1/4"
DR14L	50	1/4"
DR1764	10	17/64"
DR932	10	9/32"
DR1964	10	19/64"
DR516	10	5/16"
DR2164	10	21/64"
DR1132	10	11/32"
DR2364	10	23/64"
DR38	10	3/8"
DR2564	10	25/64"
DR1332	5	13/32"
DR2764	5	27/64"
DR716	5	7/16"
DR2964	5	29/64"
DR1532	5	15/32"
DR3164	5	31/64"
DR12	5	1/2"



ALPEN 'Sprint Master' HSS Jobber Twist Drills - Metric

DIN 338.

Part No.	Qty	Ø
DRM1	10	1 mm
DRM1.5	10	1.5 mm
DRM2	10	2 mm
DRM2.5	10	2.5 mm
DRM3	10	3 mm
DRM3.2	10	3.2 mm
DRM3.3	10	3.3 mm
DRM3.5	10	3.5 mm
DRM4	10	4 mm
DRM4.5	10	4.5 mm
DRM4.8	10	4.8 mm
DRM5	10	5 mm
DRM5.5	10	5.5 mm
DRM6	10	6 mm
DRM6.5	10	6.5 mm
DRM7	10	7 mm
DRM7.5	10	7.5 mm
DRM8	10	8 mm
DRM8.5	10	8.5 mm
DRM9	10	9 mm
DRM9.5	10	9.5 mm
DRM10	10	10 mm
DRM10.5	5	10.5 mm
DRM11	5	11 mm
DRM11.5	5	11.5 mm
DRM12	5	12 mm
DRM12.5	5	12.5 mm
DRM13	5	13 mm

BEST
SELLER



ALPEN 'Sprint Master' HSS Jobber Drill Set - Metric Sizes

DIN 933.

Supplied in a plastic selector.

Part No. Qty Description

DRK19 1 Set **19 Piece Set**

19 x Metric Sizes: 1.0 - 10.0 mm in 0.5 mm steps.



NEW



ALPEN 'Sprint Master' HSS Jobber Drill Set - Metric Sizes

DIN 338.

Supplied in a plastic storage case.

Sizes 2-3 mm are gold in colour.

Part No. Qty Description

TM13 1 Set **13 Piece Set**

13 x Metric Sizes: 2-8 mm in 0.5 mm steps.



The Alpen Sprint HSS range of jobber drills have been superseded with the Alpen Sprint Master range. Please be aware that during stock changeover you may receive the Sprint version of some items.



ALPEN 'Sprint' HSS Jobber Drill Set - Metric Sizes

DIN 338. Supplied in a metal dispenser.

Part No.	Qty	Description
DRK25	1 Set	25 Piece Set

25 x Metric Sizes: 1.0 - 13.0 mm in 0.5 mm steps.



ALPEN Metal Drill Dispenser - Metric

Holds 25 Drills from 1 - 13 mm in 0.5 mm steps. Supplied empty.

Part No.	Qty	Description
DRD25	1	Drill Dispenser



PCL 10 mm (3/8") Pneumatic Reversible Drill

Ideal for drilling, reaming and honing. Side mounted forward/reverse shift, fitted with 10 mm (3/8") keyless chuck.

Free speed 1,800 RPM, Air Consumption 130 l/min, Sound 87 db (A), Vibration 1.5 m/s² Weight 1.1 kg.

Part No.	Qty	Description
ALT3	1	10 mm Reversible Drill



ALPEN 'Super' HSS (Ground Flute) Jobber Twist Drills - Metric

DIN 338.

Part No.	Qty	Ø
DGM1	10	1 mm
DGM1.5	10	1.5 mm
DGM2	10	2 mm
DGM2.5	10	2.5 mm
DGM3	10	3 mm
DGM3.5	10	3.5 mm
DGM4	10	4 mm
DGM4.5	10	4.5 mm
DGM5	10	5 mm
DGM5.5	10	5.5 mm
DGM6	10	6 mm
DGM6.5	10	6.5 mm
DGM7	10	7 mm
DGM7.5	10	7.5 mm
DGM8	10	8 mm
DGM8.5	10	8.5 mm
DGM9	10	9 mm
DGM9.5	10	9.5 mm
DGM10	10	10 mm
DGM10.5	5	10.5 mm
DGM11	5	11 mm
DGM11.5	5	11.5 mm
DGM12	5	12 mm
DGM12.5	5	12.5 mm
DGM13	5	13 mm



KRINO HSS Jobber Drill Set - Metric Sizes

DIN 338. Supplied in a metal dispenser.

Part No.	Qty	Description
TLD19	1 Set	19 Piece Set

19 Metric Sizes: 1.5 - 10 mm in 0.5 mm steps.



KRINO HSS Jobber Drill Set - Metric Sizes

DIN 338. Supplied in a metal dispenser.

Part No.	Qty	Description
TLD25	1 Set	25 Piece Set

25 Metric Sizes: 1.5 - 13 mm in 0.5 mm steps.



KRINO HSS Jobber Drill Set - Imperial Sizes

DIN 338. Supplied in a metal dispenser.

Part No.	Qty	Description
TLD29	1 Set	29 Piece Set

29 Imperial Sizes: 1/16"-1/2" in 1/64" steps





ALPEN HSS-Co Cobalt Split Point Jobber Twist Drills

DIN 338.

5% Cobalt alloy content.

Part No.	Qty	Ø
DCB1	1	1 mm
DCB1.5	1	1.5 mm
DCB2	1	2 mm
DCB2.5	1	2.5 mm
DCB3	1	3 mm
DCB3.2	1	3.2 mm
DCB3.3	1	3.3 mm
DCB3.5	1	3.5 mm
DCB4	1	4 mm
DCB4.5	1	4.5 mm
DCB4.8	1	4.8 mm
DCB5	1	5 mm
DCB5.5	1	5.5 mm
DCB6	1	6 mm
DCB6.5	1	6.5 mm
DCB7	1	7 mm
DCB7.5	1	7.5 mm
DCB8	1	8 mm
DCB8.5	1	8.5 mm
DCB9	1	9 mm
DCB9.5	1	9.5 mm
DCB10	1	10 mm
DCB10.5	1	10.5 mm
DCB11	1	11 mm
DCB11.5	1	11.5 mm
DCB12	1	12 mm
DCB12.5	1	12.5 mm
DCB13	1	13 mm

ALPEN HSS-Co Cobalt Jobber Drill Sets - Metric Sizes

Cross cut point. DIN 338. Supplied in a metal dispenser.

Part No.	Qty	Description
DCK19	1 Set	19 Piece Set 19 x Metric Sizes: 1.0 - 10.0 mm in 0.5 mm steps.



ALPEN HSS-Co Cobalt Jobber Drill Sets - Metric Sizes

Cross cut point. DIN 338. Supplied in a metal dispenser.

Part No.	Qty	Description
DCK25	1 Set	25 Piece Set 25 x Metric Sizes: 1.0 - 13.0 mm in 0.5 mm steps.



DORMER 'A777' HSS-Co Cobalt Jobber Twist Drills - Metric

Bronze Finish, 135° 4 Facet Point. DIN 338.

Part No.	Qty	Ø
DXC2.5	10	2.5 mm
DXC3.0	10	3 mm
DXC3.2	10	3.2 mm
DXC3.3	10	3.3 mm
DXC3.5	10	3.5 mm
DXC4.0	10	4 mm
DXC4.5	10	4.5 mm
DXC5.0	10	5 mm
DXC5.5	10	5.5 mm
DXC6.0	10	6 mm
DXC6.5	10	6.5 mm
DXC8.0	10	8 mm



DORMER 'A723' Spot Weld Drills

HSCo. Bronze finish.

Part No.	Qty	Ø	Length
DDW1	1	6.0 mm	66 mm
DDW2	1	6.0 mm	93 mm
DDW3	1	8.0 mm	79 mm
DDW4	1	8.0 mm	117 mm



ALPEN HSS-Co Cobalt Spot Weld Drills

Part No.	Qty	Ø x Length
TL535	1	6 mm x 80 mm
TL538	1	8 mm x 80 mm



ALPEN HSS-Co Cobalt Spot Weld Drills

Part No.	Qty	Ø x Length
TL526	1	8 mm x 80 mm

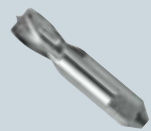

ALPEN HSS-Co Cobalt Spot Weld Drills

Part No.	Qty	Ø x Length
TL536	1	8 mm x 40 mm
TL537	1	8 mm x 44 mm



ALPEN 'Sprint Master' HSS Reduced Shank Jobber Drills

Part No.	Qty	Ø	Shank Ø
DRS14	1	14 mm	9.5 mm
DRS15	1	15 mm	9.5 mm
DRS16	1	16 mm	9.5 mm
DRS18	1	18 mm	12.5 mm
DRS19	1	19 mm	12.5 mm
DRS20	1	20 mm	12.5 mm



ALPEN HSS Blacksmiths' Drills

1/2" Parallel Shank. DIN WN 734.

Part No.	Qty	Ø
DR916	1	9/16"
DR34	1	3/4"
DR58	1	5/8"
DR1316	1	13/16"
DR1116	1	11/16"
DR78	1	7/8"



ALPEN Masonry Drill Set

Supplied in a plastic storage case.

Part No.	Qty	Description
DRK8	1 Set	8 Piece Set

8 x Sizes: 3, 4, 5, 6, 7, 8, 9, 10 mm.



ALPEN 'Super' HSS Stub Drills

DIN WN 301.

Part No.	Pack of	Ø
DRST18	10	3.2 mm



ALPEN HSS Stub Drills

Double-Ended. DIN WN 321.

Part No.	Pack of	Ø
DRST32	10	3.2 mm



ALPEN HSS-Co Cobalt Stub Drill Set

Cross Cut Point.
DIN 1897 PZ.
Supplied in a
plastic storage case.

Part No.	Qty	Description
DCK6	1 Set	6 Piece Set

6 x Metric Sizes: 2, 3, 4, 5, 6, 8 mm.



ALPEN 'Profi Multicut' Universal Drill Set

Tungsten carbide.
Supplied in a plastic storage case.

- High working speed
- No bit changes
- Extremely versatile
- All diamond-ground cutting edges, so also ideal for metals
- Precise drilling - even with changing drills in various materials
- Patented 4-stage profile for fast bore-dust removal

Part No.	Qty	Descriptions
DPMK5	1 Set	5 Piece Set

5 x Sizes: 4, 5, 6, 8, 10 mm.



EXACT HSS Step Drill & Milling Cutter

Part No.	Qty	Size/Steps
TL569	1	4 - 12 mm in 2 mm Steps



EXACT HSS Step Drills

Part No.	Qty	Range/Steps
TL577	1	4 - 20 mm in 2 mm steps
TL578	1	6 - 30 mm in 2 mm steps
TL573	1	4 - 12 mm in 1 mm steps
TL571	1	12 - 20 mm in 1 mm steps
TL572	1	20 - 30 mm in 1 mm steps



EXACT HSS Taper Drills (Cone Cutter)

Part No.	Qty	Range
TL581	1	8 - 20 mm
TL582	1	16 - 30 mm



HSS Countersinks

Part No.	Qty	Ø
TL586	1	12.4 mm
TL587	1	20.5 mm



Looking for
Carbide Mill Cutters?

Our full range is on Page 234





Drill Chucks

Complete with chuck keys.

Part No.	Qty	Mount	Capacity	Key Type
DRC1	1	3/8" x 24 F	1 - 10 mm	S2A



Drill Chucks

Complete with chuck keys.

Part No.	Qty	Mount	Capacity	Key Type
DRC2	1	1/2" x 20 F	1.5 - 13 mm	S2A



Keyless Drill Chucks

Suitable for rotary percussion drilling but should be used with SDS type impact action.

- Keyless convenience - Fast bit changeover, and no lost keys.

Part No.	Qty	Mount	Capacity
DRC5	1	3/8" x 24	1.5 - 10 mm
DRC6	1	1/2" x 20	2 - 13 mm



Replacement Chuck Keys

Part No.	Pack of	Key Type	Suits Part No.s
DKEY3	5	S2A	DRC1, DRC2
DKEY2	5	For JACOBS K30 or RÖHM S8 Types	



Rethreading Tap Set

DIN 352 (HSS Hand Taps), DIN 1814 (Adjustable Tap Wrench). Supplied in a metal dispenser.

Part No.	Qty	Description
TL541	1 Set	22 Piece Set

21 x Hand Taps: M3, M4, M5, M6, M8, M10, M12. 1 x Adjustable Tap Wrench No. 1, 1/2" for taps: M1 - M12.



TENG TOOLS Rethreading Tap & Die Set

Supplied in a tool tray.

Part No.	Qty	Description
TTTTD17	1 Set	17 Piece Set

7 x Metric Dies: 3 x 0.5, 4 x 0.7, 5 x 0.8, 6 x 1.0, 8 x 1.25, 10 x 1.5, 12 mm x 1.75.
7 x Metric Taps: 3, 4, 5, 6, 8, 10, 12 mm. 1 x Tap Handle, capacity 3 to 12 mm.
1 x Die Handle with adjustment screw, capacity 3 to 12 mm. 1 x Screw pitch gauge.



Rethreading Tap & Die Set

HSS-G Hand Taps. For metric ISO-thread DIN 13, tolerance 6H. DIN 352 (Hand Taps), DIN 1814 (Adjustable Tap Wrench), DIN 223 (Round Dies), DIN 225 (Die Stock). Supplied in a metal dispenser.

Part No.	Qty	Description
TL540	1 Set	32 Piece Set

21 x Hand Taps: M3, M4, M5, M6, M8, M10, M12. 7 x Round Dies: M3, M4, M5, M6, M8, M10, M12.
1 x Dies Stock, 25 x 9 mm: M7 - M9. 1 x Adjustable Tap Wrench No. 1, 1/2" for taps: M1 - M12.
1 x Screwdriver. 1 x Thread Gauge: Metric.



Thread Repair Files

For defect inner and outer threads. Suitable for the repair of both right as well as left hand threads with different diameters. Length: 230 mm.

Part No.	Qty	Thread Type
TL7635	1	Metric Sizes

8 x Pitches: 0.80, 1.00, 1.25, 1.50, 1.75, 2.00, 2.50, 3.00 mm.

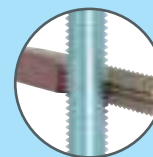

Part No.	Qty	Thread Type
TL7636	1	Imperial Sizes

8 x Pitches: 24, 20, 18, 16, 14, 12, 11, 10 Pitch Per Inch.



Tap Wrench Adjustable Type

DIN 1814.

Part No.	Qty	Size	for Taps
TL547	1	No. 2	M3.5 - M12



Tap Wrench with Ratchet

Part No.	Qty	Length	for Taps
TL546	1	100 mm	M5 - M12



Dies

DIN 223.

Part No.	Qty	Thread x Pitch
TL521	1	M5 x 0.80 mm
TL522	1	M6 x 1.00 mm
TL523	1	M8 x 1.25 mm
TL524	1	M10 x 1.50 mm
TL525	1	M12 x 1.75 mm



Hand Taps

HSS-G ground thread. DIN 352, DIN 13. Kit contains Taper, Second and Plug.

Part No.	Set of	Thread x Pitch
TL549	3	M5 x 0.80 mm
TL542	3	M6 x 1.00 mm
TL543	3	M8 x 1.25 mm
TL544	3	M10 x 1.50 mm
TL545	3	M12 x 1.75 mm



Thread Insert System Kits

Supplied in a robust plastic storage case.

Part No.	Qty	Size	Pitch
HRK105	1 Kit	M5	0.80 mm
HRK106	1 Kit	M6	1.00 mm
HRK108	1 Kit	M8	1.25 mm
HRK110	1 Kit	M10	1.50 mm
HRK112	1 Kit	M12	1.75 mm

Kit contains: 1 x Pre-wind Installation Tool. 1 x HSS-G Tap. 1 x HSS Drill: 5.2 mm 1 x Tang Break-off Tool: No. 8. 20 x Inserts.



Insert Replacement Packs - Metric

Part No.	Pack of Size	Pitch
HRP105	10 M5	0.80 mm
HRP106	10 M6	1.00 mm
HRP108	10 M8	1.25 mm
HRP110	10 M10	1.50 mm
HRP112	10 M12	1.75 mm



Thread Repair Kit - Spark Plug Inserts

Supplied in a robust plastic storage case.

Part No.	Qty	Size	Pitch
HRK214	1 Kit	M14	1.25 mm

Kit contains: 1 x Pre-wind Installation Tool. 1 x HSS-G Tap. 5 x Inserts M14 x 1.25 mm: 8.4 mm, 12.4 mm, 16.4 mm Reach.



Insert Replacement Packs - Spark Plug M14 x 1.25 mm

Part No.	Pack of Size	Reach
HRP208	10 M14 x 1.25 mm	1/2"
HRP212	10 M14 x 1.25 mm	3/4"



Lambda Sensor Thread Repair Kit

Chrome Molybdenum. Supplied in robust storage case.

- Quick and easy repair without component disassembly. Repairs damaged Lambda Probe Threads.

Part No.	Qty	Description
TL1200	1 Set	9 Piece Set

1 x Reamer and insert tool. 5 x Insert nuts with collar. 2 x Taps: M18 x 1.5 mm x 50 mm, M20 x 1.5 mm x 50 mm.





MORSE Master Cobalt® Hole Saws

Bi-metal with HSS M3 cutting edge.
4/6 variable pitch positive rake teeth.
1 1/2" cutting depth. Cuts through 2 x 4's.
Now comes with a D slot. 100mm extra cutting depth with new teeth.

Part No.	Qty	Ø		For use with Arbor Part No's
TNAV10	1	5/8"	(16 mm)	TNM24K, TNM34
TNAV12	1	3/4"	(19 mm)	TNM24K, TNM34
TNAV125	1	20 mm		TNM24K, TNM34
TNAV14	1	7/8"	(22 mm)	TNM24K, TNM34
TNAV155	1	1"	(25 mm)	TNM24K, TNM34
TNAV18	1	1 1/8"	(29 mm)	TNM24K, TNM34
TNAV19	1	1 3/16"	(30 mm)	TNM24K, TNM34
TNAV20	1	1 1/4"	(32 mm)	TNM45, TNM45P
TNAV24	1	1 1/2"	(38 mm)	TNM45, TNM45P
TNAV28	1	1 3/4"	(44 mm)	TNM45, TNM45P
TNAV315	1	50 mm		TNM45, TNM45P
TNAV32	1	2"	(51 mm)	TNM45, TNM45P
TNAV36	1	2 1/4"	(57 mm)	TNM45, TNM45P
TNAV40	1	2 1/2"	(64 mm)	TNM45P
TNAV44	1	2 3/4"	(70 mm)	TNM45P
TNAV48	1	3"	(76 mm)	TNM45P
TNAV64	1	4"	(102 mm)	TNM45P

MORSE Hole Saw Arbors

Complete with pilot drill.



Part No.	Qty	Fits Hole Saw	Thread	Shank / For Chuck
TNM24K	1	14 - 30 mm	1/2" (20 mm)	1/4" Round / 1/4" & Up



Part No.	Qty	Fits Hole Saw	Thread	Shank / For Chuck
TNM34	1	14 - 30 mm	1/2" (20 mm)	3/8" Hex / 3/8"



Part No.	Qty	Fits Hole Saw	Thread	Shank / For Chuck
TNM45P	1	32 - 152 mm	5/8" (18 mm)	7/16" Hex / 1/2"



MORSE Mechanics' Hole Saw Kit

Supplied in a plastic storage case.

Part No.	Qty	Description
TNAV5M	1 Set	6 Piece Set
5 x Hole Saws: 22, 25, 29, 32, 38 mm. 1 x Arbor: 3/8" hex shank for 3/8" chuck.		



MORSE Plumbers' Hole Saw Kit

Supplied in a plastic storage case.

Part No.	Qty	Description
TNAV2P	1 Set	9 Piece Set
7 x Hole Saws: 22, 29, 35, 38, 44, 48, 50 mm. 2 x Arbors: 7/16 hex shank for 1/2" chuck.		



MORSE Pilot Drills

Split point, shank ground on 3 sides.

Part No.	Qty	Ø		For use with Arbor Part No's
TN200	1	1/4" x 4 1/4"	(6.5 mm x 115 mm)	TNM24K, TNM34
TN250	1	1/4" x 3"	(6.5 mm x 76 mm)	TNM45, TNM45P

Need more?

More cutting blades can be found overleaf and this handy Jab Saw handle can be found on Page 427





MORSE Hacksaw Blades

Bi-metal flexible blade with 8% cobalt HSS variable tooth pitch cutting edge.
 • Teeth are brought into action at varying angles for faster, smoother cutting.

Part No.	Qty	Pitch
TL622A	Pack of 10	14/18 TPI
TL622	Box of 100	14/18 TPI
TL623A	Pack of 10	20/24 TPI
TL623	Box of 100	20/24 TPI
TL624A	Pack of 10	26/32 TPI
TL624	Box of 100	26/32 TPI



MORSE Hacksaw Frame

Complete with MORSE Bi-metal HSS Blade - 20/24 TPI.

Part No.	Qty	Description
TL631	1	Hacksaw Frame

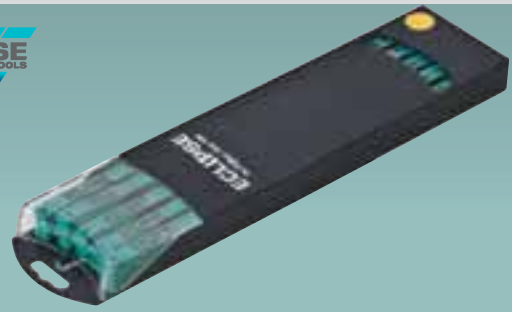

ECLIPSE Hacksaw Blades

Flexible bi-metal high speed steel. Blade size: 300 x 12.5 x 0.63 mm (12 x 1/2 x 0.025"). Virtually unbreakable for durability and safety. Cuts through all materials including alloy and stainless steel.

Part No.	Qty	Pitch
TL607A	Pack of 10	18 TPI
TL607	Box of 100	18 TPI
TL608A	Pack of 10	24 TPI
TL608	Box of 100	24 TPI
TL609A	Pack of 10	32 TPI
TL609	Box of 100	32 TPI



ECLIPSE 'Pro-Plus' Hacksaw Frame

Strong, lightweight frame for greater comfort and control when sawing with soft-feel handle for comfort. Complete with ECLIPSE 'Plus 30' 24 TPI bi-metal blade.

Part No.	Qty	Description
TL605	1	22T 'Pro-Plus' Hacksaw



BAHCO '317' Hacksaw

Alternative 90° blade mounting makes flush cutting possible. Complete with BAHCO 'Sandflex®' Bi-Metal 24 TPI Blade.

Part No.	Qty	Description
TB317	1	'317' Hacksaw



BAHCO '319' Hacksaw

Steel tube core and comfortable plastic covering. Alternative 55° blade mounting for flush cutting. Complete with BAHCO 'Sandflex®' Bi-Metal 24 TPI Blade.

Part No.	Qty	Description
TB319	1	'319' Hacksaw



BAHCO 'Sandflex®' Hacksaw Blades

Bi-metal flexible high speed steel. BAHCO Ref: 3906.

Part No.	Qty	Pitch
TB1018C	Pack of 30	18 TPI
TB1018	Box of 100	18 TPI
TB1024C	Pack of 30	24 TPI
TB1024	Box of 100	24 TPI
TB1032C	Pack of 30	32 TPI
TB1032	Box of 100	32 TPI





ECLIPSE Powersaw Blades

All Hard HSS. 350 x 25 x 1.60 mm (14" x 1" x .050").

Part No.	Qty	Length x Width x Thickness	Pitch
TL633	10	350 x 25 x 1.60 mm	10 TPI
TL634	10	350 x 25 x 1.60 mm	14 TPI



BAHCO 'High Speed' Power Hacksaw Blades

All hard HSS. BAHCO Ref: 3802.

Part No.	Qty	Length x Width x Thickness	Pitch
TB2221	10	300 x 25 x 1.25 mm	14 TPI
TB2320	10	350 x 25 x 1.25 mm	10 TPI
TB2321	10	350 x 25 x 1.25 mm	14 TPI
TB2330	10	350 x 32 x 1.60 mm	10 TPI
TB2331	10	350 x 32 x 1.60 mm	14 TPI
TB2430	10	400 x 32 x 1.60 mm	10 TPI



Flexback Bandsaw Blades

High performance hard tooth, flexible back carbon steel bandsaw for cutting most materials including wood, plastic and non-ferrous metals.

Part No.	Qty	Width x Thickness x Pitch	Length	Type
TL590	1	1/2" x 0.25" x 14 TPI	7' 10 1/4"	Reg Raker
TL591	1	1/2" x 0.25" x 14 TPI	7' 3 1/2"	Reg Raker
TL592	1	1/2" x 0.25" x 24 TPI	7' 10 1/4"	Reg Wavy
TL594	1	1/2" x 0.25" x 24 TPI	7' 3 1/2"	Reg Wavy
TL593	1	1/2" x 0.25" x 6 TPI	7' 3 1/2"	Skip Raker



M42 Bi-Metal Bandsaw Blades

Ideal for general purpose cutting and contour cutting of tubing, structurals and solids, especially in fabrication applications or where the material is proven to vibration.

Part No.	Qty	Width x Thickness x Pitch	Length
TL595	1	1/2" x 0.25" x 14 TPI	7' 10 1/4"
TL596	1	1/2" x 0.25" x 10 TPI	7' 10 1/4"



TENG TOOLS Mini Hacksaw

Complete with 3 x 6" mini hacksaw blades.

• Six position blade setting.

Part No.	Qty	Description
T705	1	Mini Hacksaw Frame



Junior Hacksaw Blades

For Metal Cutting 6" x 32 TPI.

Part No.	Pack of	Description
TL638	10 x 10	Junior Hacksaw Blades



BAHCO '268' Junior Hacksaw

Chrome finish with glass fibre handle. Complete with 150 mm 32 TPI blade.

Part No.	Qty	Description
TB268	1	'268' Junior Hacksaw



BAHCO '268' Junior Hacksaw Blades

Part No.	Pack of	Pitch
TB2032	10	32 TPI



SafeSaw System - Steel Set

Compatible with 115 mm angle grinders. Max speed: 19,000 RPM.

The SafeSaw System universal cutting blade will cut through most materials, including: Wood and wood with nails, aluminium, steel and iron up to 8 mm thick. Ideal for exhausts, studding and steel panels.

Part No.	Qty	Description
TL615	1 Set	SafeSaw System Set
TL616	1	Replacement 115 mm Steel Blade

1 x Safety Guard. 1 x Arbour Kit. 1 x Spanner. 1 x Steel Blade: 115 mm x 25.4 mm.



MORSE Jab Saw

Heavy duty. Supplied complete with 6" x 6 TPI bi-metal reciprocating saw blade.

- Easily change blades - Suitable for use with reciprocating saws and standard hacksaw blades
- Ideal for use in tight and confined places

Part No.	Qty	Description
TL625	1 Set	2 Piece Set



MORSE Reciprocating Saw Blades

Suitable for use with Jab Saw (Part No. TL625). Universal fitting, fits all popular reciprocating saw machines 8% Cobalt edge offers more wear resistance. Matrix II cutting edge has shock resistance teeth that resist strippage.

- Applications Include: Machinable metal, wood, nail-embedded wood, composites, rubber, plastic, plaster and other common building materials.

Part No.	Qty	Length x Pitch	Applications
TL629	5	6" x 6 TPI	Wood, Wood/Nails
TL627	5	6" x 10 TPI	Metal, Wood, Wood/Nails
TL626	5	6" x 14 TPI	Metal
TL628	5	6" x 18 TPI	Metal



MORSE Heavy Duty Reciprocating Saw Blade Kit

NOT suitable for use with Jab Saw (Part No. TL625).

Universal fitting, fits all popular reciprocating saw machines. 8% Cobalt edge offers more wear resistance. Matrix II cutting edge has shock resistance teeth that resist strippage.

- Applications: Machinable metal, wood, nail-embedded wood, composites, rubber, plastic, plaster and other common building materials.

Part No.	Qty	Description
TL630	1 Kit	11 Piece Kit

1 x Blade Storage Tube. 2 x 9" x 8/11 TPI Renovator Blades. 3 x 6" x 8/11 TPI Renovator Blades. 2 x 6" x 6 TPI Havoc Blades. 2 x 6" x 10 TPI Havoc Blades. 2 x 9" x 6 TPI Havoc Blades.



BAHCO '244' Handsaw

Hard point with screwed plastic handle. For medium thick wood materials. For cutting along, as well as across, the grain.

Part No.	Qty	Description
TB244	1	22" Handsaw



BAHCO Jig Saw Blades - High Speed Steel

Euro Shank (Type 3802).

Fits: AEG, ATALS COPCO, BOSCH, DeWALT, HITACHI, MAKITA, METABO, MILWAUKEE and Similar Machines. Supplied on a blister card.

Part No.	Pack of	Length x TPI	Thickness Range	Material
TB4512	5	75 mm x 24 TPI	1 - 3 mm	Metal
TB4522	5	75 mm x 14 TPI	2.5 - 6 mm	Metal



Jig Saw Blades - BOSCH Fitting

For AEG, BOSCH, ELU, FESTO, FLEX, HITACHI, HOLZHER, MAFELL, MAKITA and METABO.

- Applications: Soft steel, aluminium, non-ferrous metal, up to 2 mm.

Part No.	Pack of	Type
TL645	5	T118A



Jig Saw Blades - BOSCH Fitting

For AEG, BOSCH, ELU, FESTO, FLEX, HITACHI, HOLZHER, MAFELL, MAKITA and METABO.

- Applications: Softwood, hardwood, plastic up to 60 mm rough cut.

Part No.	Pack of	Type
TL647	5	T111C



Air Saw Blades

SIG, flexi soft metals up to 2 mm.

Part No.	Pack of	Pitch
TL654	5	14 TPI
TL649	5	24 TPI
TL655	5	32 TPI





HYDE 'MAXXGRIP PRO'® Stiff Scraper - Chisel-Ended

High carbon steel blade, mirror finish.

- Full tang blade construction.
- Ergo-engineered soft-grip handle to reduce fatigue, absorb shock and increase comfort during extended use.

Part No.	Qty	Blade Width
TNY3	1	3" (76 mm)



HYDE 'MAXXGRIP PRO'® Stiff Scraper

High carbon steel blade, mirror finish.

- Full tang blade construction.
- Ergo-engineered soft-grip handle to reduce fatigue, absorb shock and increase comfort during extended use.

Part No.	Qty	Blade Width
TNY1	1	1 1/2" (38 mm)
TNY2	1	2" (51 mm)



HYDE 'Black & Silver' Scraper - 5-in-1 Painter Tool

High carbon steel blade, mirror finish. Full tang blade construction. Nylon handle resists most paint thinners and solvents.

Part No.	Qty	Blade Width
TNY119	1	2 1/2" (63 mm)



HYDE 'Black & Silver' Scraper - Chisel-Ended/Putty Knife

High carbon steel blade, mirror finish. Full tang blade construction. Nylon handle resists most paint thinners and solvents.

Part No.	Qty	Blade Width
TNYP114	1	1 1/4" (32 mm)



KS TOOLS Chisel Scraper Set

INOX stainless steel. Hammer through design.

Part No.	Qty	Description
K907.2210	1 Set	4 Piece Set
2 x 1.2 mm Scrapers: 25, 32 mm wide.		
2 x 2.5 mm Chisel scrapers: 25, 32 mm wide.		



'Razor-Mate' Scrapers

Various colour vinyl grips. Supplied in a screw-top plastic jar.

Part No.	Qty	Descriptions
TNH52230	Jar of 30	'Razor-Mate' Scrapers



'Zippy' Type Scrapers & Blades

Supplied with 5 x single edge steel razor blades.

Part No.	Qty	Description
TL671	5 Sets	Scrapers with 5 Blades



Single Edge Steel Razor Blades for 'Zippy' Type Scrapers

Suitable for use with Part No.s TL671 and TNH52230.

Part No.	Box of	Description
TL672	100	Razor Blades



KS TOOLS Jack Knife

- Supplied complete with nylon belt bag.
- Teflon® coated blade with lock function.
- Anti-slip handle with finger recesses

Part No.	Qty	Description	Overall Length
K907.2105	1	Jack Knife	193 mm



BAHCO Pocket Knife

Stainless steel folding blade. Flat design to fit in pocket easily.

Part No.	Qty	Description	Overall Length
TB1	1	Stainless Steel Knife	175 mm

Looking for Snap-off Knives?

Our range of Knives + Blades continues overleaf on Page 430

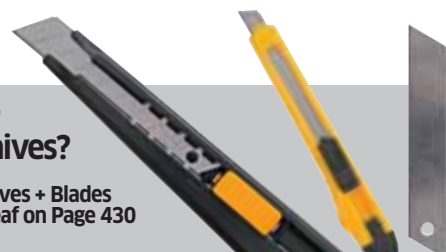



COAST Multi-Tool with 2 x LED Lights

Stainless steel tool construction in anodized silver finish. Includes 2 x inbuilt LED lights. Supplied with pocket/belt pouch.

- Spring-loaded pliers for auto-opening/added torque using pliers, wire cutter/stripper
- Individual tools can be opened with handles in closed position - quick/easy access
- Ergonomic design, handle ideal compliments each of the working tools in use
- LED light in closed position, shine ahead of knife blade & pliers when in working use

Part No.	Qty	Description
----------	-----	-------------

TL683 1 Multi-Tool

1 x Professional quality knife, pliers, wire cutter, wire stripper, cap lifter, can opener and scissors. 4 x screwdrivers.



Trimming Knife Blades - Standard Trapezoid Type

Supplied with 100 x All metal blades. Heavy duty.

Part No.	Box of	Description
----------	--------	-------------

TL658 100 Trim Knife Blades in Dispenser



BEST SELLER

Trimming Knife Blades - Standard Trapezoid Type

All metal. Heavy duty.

Part No.	Pack of	Description
----------	---------	-------------

TL662 10 x 10 Trim Knife Blades



KS TOOLS Folding Knife

Metal construction with belt hook. Quick-locking blade mechanism. Supplied with 5 x standard 'Trapezoid' blades.

Part No.	Qty	Description	Overall Length
----------	-----	-------------	----------------

K907.2174 1 Set Knife with 5 Blades 155 mm



COAST 'Pro Razor' Folding Knife

Stainless steel frame with nylon handle with belt clip. Supplied with 4 standard 'Trapezoid' blades, 1 fitted and 3 in handle storage.

- Folding knife with 'Double Lock' system for added safety
- 'E-Z change' blade replacement feature

Part No.	Qty	Description	Overall Length
----------	-----	-------------	----------------

TL682 1 Folding Knife 188 mm



TENG TOOLS Utility Knife - Retractable Blade

Complete with 2 x standard 'Trapezoid' blades.



Part No.	Qty	Description
----------	-----	-------------

T710 1 Heavy Duty Utility Knife



Trimming Knife All Metal with Top Lever Retractor

Uses standard 'Trapezoid' blades.

Part No.	Qty	Description
----------	-----	-------------

TL659 1 Trim Knife



Trimming Knife Spring-loaded Automatic Retractor

Uses standard 'Trapezoid' blades.

Part No.	Qty	Description
----------	-----	-------------

TL660 1 Auto Retract Knife



Contractors' Trimming Knife Automatic Reloading

Complete with 10 x heavy duty Sheffield made standard 'Trapezoid' blades.

- Internal storage for 10 blades (included)
- No tools required to change blade
- Soft hand grip
- Quick push button blade removal
- Blade retraction button

Part No.	Qty	Description
----------	-----	-------------

TL670 1 Contractors' Knife



TENG TOOLS Utility Knife - Heavy Duty with Retractable Blade

Complete with 2 x standard 'Trapezoid' blades.

- Ergonomic handle with non-slip section
- Quick opening and closing
- 3-step blade adjustment
- Spare blade storage inside handle

Part No.	Qty	Description
----------	-----	-------------

T710N 1 Utility Knife



KS TOOLS Long Knife For Scraping

Stable aluminium knife with non-slip grip with trapezoid blade.

For use with standard trapezoid and hook blades. Blade magazine in knife.

Part No.	Qty	Length
----------	-----	--------

K140.2290 1 470 mm





OLFA Trimming Knives with 'Snap-off' Blades

Heavy duty metal body.

Part No.	Pack of	Blade Width
TL673	6	9 mm Blade
TL675	1	18 mm Blade
TL677	1	25 mm Blade



OLFA Trimming Knife Blades 'Snap-off' Type

Supplied in a plastic storage box.

Part No.	Pack of	Blade Width
TL678	20	25 mm

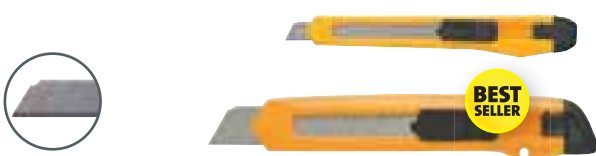

Trimming Knives with 'Snap-off' Blades

Part No.	Pack of	Blade Width
TL663	10	9 mm
TL665	10	18 mm



Trimming Knife Blades 'Snap-off' Type

Part No.	Pack of	Blade Width
TL664	10 x 10	9 mm
TL666	10 x 10	18 mm



KS TOOLS Workshop Utility Scissors with Wire Cutters

Stainless steel blades. Ergonomic plastic handles. Supplied with belt storage pouch.

Part No.	Qty	Length
K118.0060	1	140 mm (4 1/2")



NWS Scissors/Shears

Stainless steel, polished cutting edges. Black varnished handles. Heavy duty. Re-adjustable screw-joint.

Part No.	Qty	Length
TL676	1	200 mm (8")



Lever Bolt Cutters

Chrome-vanadium steel forged jaws. Precision steel tube handles with PVC grips. DIN ISO 9242.

Part No.	Qty	Length	Capacity
TL230	1	610 mm (24")	8 mm Ø



ECLIPSE Tin Snips - Straight

Standard type.



Part No.	Qty	Length
TL232	1	300 mm (12")



BAHCO Cutting Pliers

Ergonomic handles. Black finish heads.

Part No.	Qty	Length
TB2101G4	1	140 mm (5 1/2")
TB2101G6	1	160 mm (6 1/4")



TENG TOOLS 'Mega Bite' Side Cutter

High carbon steel. 72° cutting edge angle. Vinyl coated handles.

Part No.	Qty	Length
TMB441-6	1	150 mm (6")



TENG TOOLS 'Mega Bite' Side Cutter - Heavy Duty

High carbon steel. 72° cutting edge angle. Vinyl coated handles.

Part No.	Qty	Length
TMB442-8	1	200 mm (8")



NWS Electricians' Miniature Side Cutters

Box jointed with double leaf spring. Soft wire capacity: 1.2 mm Ø.

Part No.	Qty	Length
TNE3	1	115 mm (4 1/2")

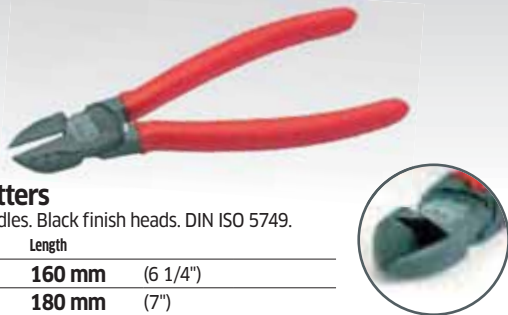

NWS Side Cutters

Plastic coated handles. Black finish heads. DIN ISO 5749.

Part No.	Qty	Length
TNP4/160	1	160 mm (6 1/4")
TNP4/180	1	180 mm (7")



NWS Heavy Duty Side Cutters

Plastic coated handles. Black finish heads. DIN ISO 5749.

Part No.	Qty	Length
TNP5/150	1	150 mm (6")
TNP5/180	1	180 mm (7")
TNP5/200	1	200 mm (8")
TNP5/240	1	240 mm (9 1/2")



NWS Side Cutter

Special tool steel, drop-forged, oil hardened. Black 'Titan' finish.

Part No.	Qty	Length
TNR4/160	1	160 mm (4 1/4")



NWS 'MultiCutter' 3-in-1 Wire Stripping Pliers

Special tool steel, drop-forged, oil-hardened. Precision cutting edges, induction hardened for hard and soft wires.

- V-shaped cutting edges for stripping of wires and stranded conductors.
- Cable stripper function for all common cables from 8 - 13 mm Ø

Part No.	Qty	Length
TNR6/180	1	180 mm (7")



NWS 'ErgoMulti' Ergonomic Electricians' Pliers

Tool steel, drop-forged, oil-hardened matt chromium plated heads. 'Soft-Grip' 2-component handles with soft inlay.

- Ergonomically angled head for strain-free working.
- Optimum power transmission from improved leverage.
- With lock and opening spring.

Part No.	Qty	Length
TNR9/200	1	200 mm (8")



NWS 'Fantastico' Heavy Duty Side Cutters

Special tool steel, drop-forged, oil hardened. Black 'Titan' finish. Red vinyl coated handles. DIN ISO 5749.

- Heavy duty lever action provides a higher torque.

Part No.	Qty	Length
TL255	1	200 mm (8")



NWS 'Fantastico' Heavy Duty Side Cutters

Special tool steel, drop-forged, oil hardened. Black 'Titan' finish.

- Heavy duty lever action provides a higher torque.

Part No.	Qty	Length
TNR255	1	200 mm (8")



NWS Cable Cutter

Special tool steel, drop-forged, oil-hardened. Titanium finish head, soft grip 2-component handles. Spring opening.

- Adjustable screw-joint.
- For stripping and cutting copper and aluminium cable up to 25 mm Ø (70 mm²).

Part No.	Qty	Length
TNR7/210	1	210 mm (8 1/4")



NWS 'PowerBolt' Heavy Duty End Cutting Nippers

Cutting edges, induction hardened, for stud bolts, nails, rives and similar materials. Cutting edges additionally induction hardened.

- Precision cutting edges, induction hardened.
- V-shaped cutting edges for stripping of wires.
- Cable stripper function: Ø 8 - 13 mm.

Part No.	Qty	Length
TNP6/200	1	200 mm (8")





NWS 4-in-1 Electricians' VDE Pliers

Special tool steel, drop-forged, oil hardened. Matt chrome plated. 'Soft-Grip' 2 component handles with soft inlay. Optimised slip guards according to IEC 60900. 1,000V

- Cuts bolts up to M3.5, strips cable 1.5/2.5 mm², crimp and bend facility.

Part No.	Qty	Length
TNV5/190	1	190 mm (7 1/2")



NWS VDE Side Cutter

'Soft-Grip' 2-component handles. Matt chromium plated heads. Optimised slip guards according to IEC 60900. 1,000V.

Part No.	Qty	Length
TNV4/160	1	160 mm (6 1/4")



NWS 'MultiCutter' 3-in-1 VDE Wire Stripping Pliers

Insulation to IEC 60900 1,000V. Matt chromium plated heads. 'Soft-Grip' 2-component handles with soft inlay.

- Precision cutting edges, induction hardened.
- V-shaped cutting edges for stripping of wires.
- Cable stripper function: Ø 8 - 13 mm.

Part No.	Qty	Length
TNV6/180	1	180 mm (7")



NWS 'ErgoMulti' High Leverage VDE Combination Pliers

Insulation to IEC 60900 1,000V. Tool steel, drop-forged, oil-hardened Matt chromium plated heads. 'Soft-Grip' 2-component handles with soft inlay.

- Ergonomically angled head for strain-free working.
- Optimum power transmission from improved leverage.
- With lock and opening spring.

Part No.	Qty	Length
TNV9/200	1	200 mm (8")



NWS VDE Combination Pliers

'Soft-Grip' 2-component handles. Matt chromium plated heads. Optimised slip guards according to IEC 60900. 1,000V.

- Integrated ring spanner

Part No.	Qty	Length
TNV1/180	1	180 mm (7")
TNV1/205	1	205 mm (8")



NWS VDE Long (Chain) Nose Pliers

'Soft-Grip' 2-component handles. Matt chromium plated heads. Optimised slip guards according to IEC 60900. 1,000V.

Part No.	Qty	Length
TNV2/205	1	205 mm (8")



NWS VDE Pliers Set

Optimised slip guards according to IEC 60900. 1,000V. Induction hardened precision edges. 2-component safety grip. For hard and soft wire.

Part No.	Qty	Description
KN782	1 Set	3 Piece Set

1 x VDE Combination: 180 mm. 1 x VDE Chain Nose: 205 mm. 1 x VDE Side Cutter: 160 mm

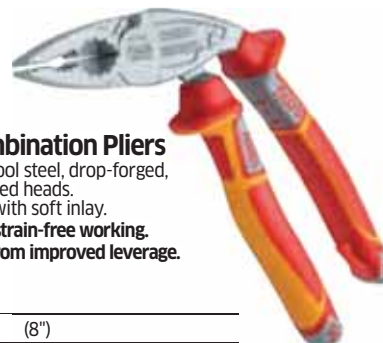

NWS 'ErgoCombi' High Leverage VDE Combination Pliers

Insulation to IEC 60900 1,000V. Tool steel, drop-forged, oil-hardened Matt chromium plated heads. 'Soft-Grip' 2-component handles with soft inlay.

- Ergonomically angled head for strain-free working.
- Optimum power transmission from improved leverage.
- Can also be used as a spanner.

Part No.	Qty	Length
TNV8/200	1	200 mm (8")

Looking for more Pliers?

Our range of Pliers continue in the next section on Page 435

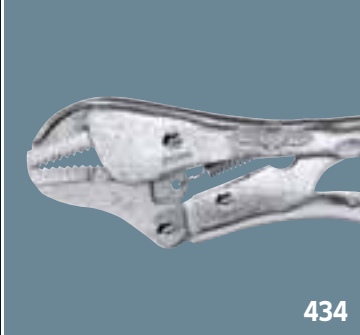

434



435



436



436



437



438



General Hand Tools



441



442



446

- 434 Locking Pliers
- 435 Pliers
- 436 Water Pump
- 436 Circlip Pliers
- 437 Measuring Tools
- 438 Hammers
- 439 Pry Bars
- 441 Chisels + Punches
- 442 Screwdrivers
- 446 Screwdriver Bits
- 447 Security Bits
- 448 Hex T-Handles
- 450 Hex Key Sets
- 452 Spanners
- 453 Adjustable Wrenches
- 454 Ratchet Spanners
- 455 Ratchets
- 456 Power Bars
- 457 Socket Accessories
- 458 Ratchet + Socket Sets
- 460 Socket Rail Sets
- 462 Regular Sockets
- 463 Deep Sockets
- 464 Impact Sockets
- 466 Impact Socket Sets



450

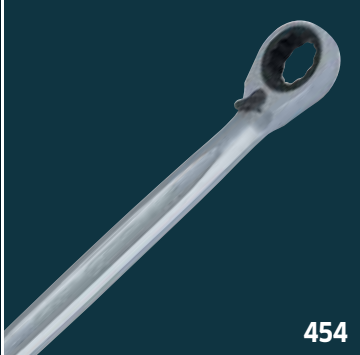

454



455



456



458



462



464



IRWIN VISE-GRIP



IRWIN VISE-GRIP Locking Pliers

Straight jaws.

Part No.	Qty	Length	Ref.
TNA7R	1	7" (175 mm)	7R
TNA10R	1	10" (250 mm)	10R

IRWIN VISE-GRIP



IRWIN VISE-GRIP Locking Pliers

Long nose with wire cutter.

Part No.	Qty	Length	Ref.
TNA4LN	1	4" (100 mm)	4LN
TNA6LN	1	6" (150 mm)	6LN
TNA9LN	1	9" (225 mm)	9LN

IRWIN VISE-GRIP



IRWIN VISE-GRIP Locking Pliers

Curved jaws with wire cutter

Part No.	Qty	Length	Ref.
TNA4WR	1	4" (100 mm)	4WR
TNA5WR	1	5" (125 mm)	5WR
TNA7WR	1	7" (175 mm)	7WR
TNA10WR	1	10" (250 mm)	10WR

IRWIN VISE-GRIP



IRWIN VISE-GRIP Locking Welding Clamp

Part No.	Qty	Length	Ref.
TNA9R	1	9" (225 mm)	9R

IRWIN VISE-GRIP



IRWIN VISE-GRIP Locking C-Clamps

Part No.	Qty	Length	Ref.
TNA6R	1	6" (150 mm)	6R
TNA11R	1	11" (275 mm)	11R

TENG TOOLS



TENG TOOLS 'Power Grip' Locking Pliers - Round & Flat Grip

Wire cutter/crimper action.

Part No.	Qty	Length	Ref.
T401-7	1	7" (180 mm)	
T401-10	1	10" (250 mm)	

TENG TOOLS



TENG TOOLS 'Power Grip' Pliers Set

Supplied in a tool tray.

Part No.	Qty	Description
TTVVG05	1 Set	5 Piece Set

3 x Combination Pliers: 4", 7", 10". 2 x Long Nose Pliers: 4", 6"

PYTHON G-Clamps



Part No.	Qty	Jaw Capacity
TL355	1	150 mm
TL356	1	200 mm

BAHCO



BAHCO Pliers Set

Ergonomic handles. Black finish heads.

Part No.	Qty	Description
TB9897	1 Set	4 Piece Set

1 x Combination Pliers: 180 mm. 1 x Snipe Nose Pliers: 160 mm.
1 x Cutting Pliers: 160 mm. 1 x Slip Joint Pliers: 250 mm.



TENG TOOLS 'Mega Bite' Combination Pliers

High leverage with pipe grip and serrated grip surfaces. High carbon steel. 72° cutting angle and titanium coated joints. Vinyl coated handles

Part No.	Qty	Length
TMB452-8	1	200 mm (8")



TENG TOOLS 'Mega Bite' Long Nose Pliers

With serrated grip surfaces. High carbon steel. 72° cutting angle and titanium coated joints. Vinyl coated handles.

Part No.	Qty	Length
TMB461-8	1	200 mm (8")



TENG TOOLS 'Mega-Bite' Pliers Set

Vinyl grips. Supplied in a tool tray.

Part No.	Qty	Description
TTT440	1 Set	4 Piece Set

1 x Side Cutter: 6". 1 x Combination: 7". 1 x Long Nose: 8". 1 x Water Pump: 10".



NWS 'ErgoCombi' High Leverage Combination Pliers

Insulation to IEC 60900 1,000V. Tool steel, drop-forged, oil-hardened Matt chromium plated heads. 'Soft-Grip' 2-component handles with soft inlay.

- Ergonomically angled head for strain-free working.
- Optimum power transmission from improved leverage.
- Can also be used as a spanner.

Part No.	Qty	Length
TNR8/200	1	200 mm (8")



NWS Combination Pliers

Plastic coated handles. Black finish heads. DIN ISO 5746.

Part No.	Qty	Length
TNP1/180	1	180 mm
TNP1/205	1	205 mm



NWS 'CombiMax' Combination Pliers

Insulation to IEC 60900 1,000 V. Matt chromium plated heads. 'Soft-Grip' 2-component handles with soft inlay.

Part No.	Qty	Length
TNR1/180	1	180 mm (7")
TNR1/205	1	205 mm (8")



NWS Long (Chain) Nose Pliers - Straight

Plastic coated handles. Black finish heads. DIN ISO 5745.

Part No.	Qty	Length
TNP2/170	1	170 mm
TNP2/205	1	205 mm



NWS Long (Chain) Nose Pliers - Straight

'Soft-Grip' 2-component handles. Titanium finish head. DIN ISO 5745.

Part No.	Qty	Length
TNR2/205	1	205 mm

Looking for VDE Pliers & Cutters?

Our VDE range of pliers and cutters features on the previous pages





NWS 'MaxiMX' Water Pump Pliers

Chrome vanadium steel, drop forged and oil-hardened with red vinyl coated handles.

- Fine 'Drag & Drop' precise adjustment.
- Safety protection of fingers in every position.



Part No.	Qty	Length		Jaw Capacity
TQ1/250	1	250 mm	(10")	50 mm
TQ1/300	1	300 mm	(12")	75 mm



TENG TOOLS 'Mega Bite' Groove Joint Pliers

Heavy duty model. Non-slip groove joints and polished head. Vinyl coated handles.

Part No.	Qty	Length		Jaw Capacity
TMB416	1	400 mm	(16")	90 mm



TENG TOOLS 'Mega Bite' Water Pump Pliers

Serrated jaws with pipe grip and titanium coated joints. Vinyl coated handles.

Part No.	Qty	Length		Jaw Capacity
TMB481-10	1	250 mm	(10")	3-38 mm



NWS 'ClassicPlus' Water Pump Pliers

DIN ISO 8976. Special tool steel, forged, oil-hardened with plastic handles.

- Jaws with nail/wire holder
- Double-toothed jaws
- Finger trap protection for safe work
- Self-locking serration



Part No.	Qty	Length		Jaw Capacity
TNP9/300	1	300 mm	(12")	2-55 mm
TNP9/400	1	400 mm	(16")	3-80 mm

2-in-1 Circlip Pliers Set - Internal & External

2-in-1 tool converts from internal to external pliers at the touch of a button. External range: 1/4" - 2" (7 - 48 mm). Internal Range: 3/8" - 2" (10 - 48 mm).



Part No.	Qty	Description
TNH521C	1 Set	12 Piece Set
1 x Pliers: 7 3/4" (197 mm). 3 x Straight Tips: .036" (0.9 mm), .047" (1.2 mm), .070" (1.8 mm). 2 x Bent 90° Tips: .036" (0.9 mm), .047" (1.2 mm).		



NWS Circlip Pliers - External Bent 90°

DIN 5254 B.

Part No.	Qty	Length	Circlip Ø mm	Tip Ø mm
TNC2/165	1	165 mm	19 - 60	1,8
TNC2/200	1	200 mm	40 - 100	2,3



NWS Circlip Pliers - External Straight

DIN 5254 A.

Part No.	Qty	Length	Circlip Ø mm	Tip Ø mm
TNC1/135	1	135 mm	12 - 25	1,3
TNC1/175	1	175 mm	19 - 60	1,8
TNC1/220	1	220 mm	40 - 100	2,3
TNC1/310	1	310 mm	85 - 140	3,2



NWS Circlip Pliers - Internal Bent 90°

DIN 5256 B.

Part No.	Qty	Length	Circlip Ø mm	Tip Ø mm
TNC4/165	1	165 mm	19 - 60	1,8
TNC4/200	1	200 mm	40 - 100	2,3



NWS Circlip Pliers - Internal Straight

DIN 5256 A.

Part No.	Qty	Length	Circlip Ø mm	Tip Ø mm
TNC3/135	1	135 mm	12 - 25	1,3
TNC3/175	1	175 mm	19 - 60	1,8
TNC3/220	1	220 mm	40 - 100	2,3
TNC3/310	1	310 mm	85 - 140	3,2



NWS Circlip Pliers Set

Part No.	Qty	Description
KN792	1 Set	4 Piece Set
1 x External Straight: 175 mm. 1 x External Bent: 165 mm. 1 x Internal Straight 175 mm. 1 x Internal Bent: 165 mm		



TENG TOOLS 'Mega-Bite' Circlip Pliers Set

7" long with return spring. Supplied in a tool tray.

Part No.	Qty	Description
TTT474-7	1 Set	4 Piece Set
1 x Inner/straight: 12 to 65 mm capacity. 1 x Inner/bent: 12 to 65 mm capacity. 1 x Outer/straight: 10 to 40 mm capacity. 1 x Outer/bent: 10 to 40 mm capacity		



BEST SELLER

Measuring Tapes

Impact resistant casing with belt clip. Push-pull blade with temporary and permanent locking buttons and "Power Return". Metric and imperial graduations.

Part No.	Qty	Length
TL695	1	5 m (16ft)
TL698	1	10 m (32ft)



BEST SELLER

Steel Rulers

Flexible stainless steel.

Part No.	Qty	Length
TL451	1	15 cm 6"
TL452	1	30 cm 12"
TL453	1	60 cm 24"

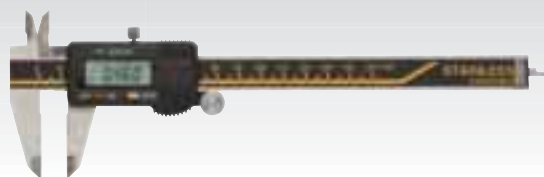

Digital Slide Vernier Caliper

Complete with LR44 1.55v battery. Supplied in a robust storage case.

Part No.	Qty	Description
TL689	1	Digital Vernier Caliper



TENG TOOLS Digital Vernier Caliper

Stainless steel. Supplied in a plastic storage box. Max length of measurement: 150 mm. Jaw length 40 mm.

- Adjustable between mm and inch
- Reading 0.01 mm
- Repeated reading ± 0.01 mm
- Zero set in any position

Part No.	Qty	Description
TL455	1	Digital Vernier Caliper

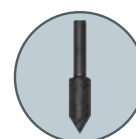

BRENNENSTUHL 'Signograph 25' Electric Engraver Kit

25W, 230V. A powerful engraver with interchangeable hardened stylus complete with hard metal stylus and stylus coupling. Cable length: 1.8 m.

- For engraving soft metal, copper, tin and aluminium.
- Includes interchangeable sintered carbide stylus for glass engraving.
- Engraving is as easy as writing.

Part No.	Qty	Description
TL995	1 Kit	25W Engraver
TL996	1	Replacement Pointed Engraver Tip



Feeler Gauges

Combination set. 3" x 1/2" Blades.

Part No.	Qty	Description
TNFG135	1 Set	32 Piece Set
30 x Steel: .002 - .035" .051 - .889 mm. 6 x Brass: .006 - .016" .152 - .406 mm.		





Cross Pein Hammer

"Toffee Hammer".

Part No.	Qty	Weight
TL713	1	1/4 lb



Lump Hammers

Part No.	Qty	Weight
TL705	1	2 1/2 lb
TL712	1	4 lb



Ball Pein Hammers

Part No.	Qty	Weight
TL707	1	1/4 lb
TL701	1	1/2 lb
TL702	1	1 lb
TL703	1	1 1/2 lb
TL704	1	2 lb
TL708	1	2 1/2 lb



Lump Hammer Shaft

Part No.	Qty	Type	Length
TL725	1	Lump	10"



Ball Pein Hammer Shafts

Engineers' Hickory/Ash (material subject to change).

Part No.	Qty	Length
TL723	1	14"
TL724	1	16"

Hammer Shaft Wedges

Part No.	Pack of	Description
TL729	20	No. 3 Wedges



Assorted Pack of Hammer Shafts

Complete with No. 3 hammer shaft wedges.

Part No.	Pack of
TL721	5 Pieces

2 x Engineers: 14" (x 2), 16" (x 2). 1 x Lump: 10" 1 x Hammer Shaft Wedges (x 5).



Sledge Hammers

Part No.	Qty	Weight
TL706	1	7 lb
TL711	1	14 lb



Sledge Hammer Shaft

Hickory. Tapered end.

Part No.	Qty	Type	Length
TL727	1	Sledge, Parallel Eye	36"



Claw Hammer

Steel shafted with grip.

Part No.	Qty	Weight
TL700	1	1 lb

BEST SELLER



THOR Soft Face Hammer - Copper & Hide Faces

Weight: 2 1/2 lb.

Part No.	Qty	Description
TL714	1	Size 2 - Soft Face Hammer
TL715	1	Replacement Copper Face
TL716	1	Replacement Hide Face



Hammer Ball Pein Fibreglass

Part No.	Qty	Weight
TL7108	1	1/2 lb
TL7116	1	1 lb
TL7124	1	1 1/2 lb
TL7132	1	2 lb
TL7140	1	2 1/2 lb



TENG TOOLS Roll/Heel Bar

Part No.	Qty	Length
TPB16	1	16"



KS TOOLS Dead Blow Hammers

Recoil free rubber mallet. Solid PU glass fibre composite. Substantially higher impact effect than with conventional mallets. Particularly suitable for careful driving of bearings, cases, sleeves, sealing rings, etc.

Part No.	Qty	Head Diameter	Weight
K140.5255	1	45 mm	940g
K140.5257	1	55 mm	1400g



TENG TOOLS Roll/Heel Bars Set

Supplied in a TTX tool tray.

Part No.	Qty	Description
TTXPB3	1 Set	3 Piece Set

Lengths: 12", 16", 20"



Dead Blow Hammer

Part No.	Qty	Weight
TL7170	1	2 lb



MAYHEW Pry Bar (Pinch Bar)/Line Up Punches

Part No.	Qty	Length
TN472	1	24"



MAYHEW Ladyfoot Pry Bars

Supplied in a plastic tray.

Part No.	Qty	Description
TN60150	1 Set	3 Piece Set

Sizes: 12", 16", 21"



Looking for more?

Our Pry Bar range continues overleaf





MAYHEW 'The Dominator' Screwdriver Pry Bars - Curved Blades

Supplied in plastic tray.

- Hardened and tempered the entire length for maximum durability.
- Two composite handle for a more comfortable and secure grip.
- All-new capped end allows user to strike pry bar with a hammer without damaging the head.

Part No.	Qty	Description
TN61355	1 Set	3 Piece Set
3 x Sizes: 7", 12" & 18"		



KS TOOLS Flat Chisel Set

Chrome molybdenum steel. Flat shaft. For work on metal.

Part No.	Qty	Description
K156.0690	1 Set	4 Piece Set
Sizes: 14,5 x 125 mm, 20,5 x 150 mm, 23 x 200 mm, 28,5 x 250 mm.		



MAYHEW Screwdriver Pry Bars

Curved blades. Supplied in a plastic tray.

Part No.	Qty	Description
TN61350	1 Set	3 Piece Set
Sizes: 7", 12", 18".		



KS TOOLS Premium Pin & Punch Set

Finest chrome vanadium steel, mirror polished. DIN 6450/DIN 6458. Supplied in a robust wall mountable metal stand/holder.

Part No.	Qty	Description
K156.0180	1 Set	18 Piece Set
5 x Punches: 2, 3, 4, 5, 6 mm. 6 x Pin Punches: 2, 3, 4, 5, 6, 8 mm.		
6 x Pin Punches, extra long: 3, 4, 5, 6, 8, 10 mm. 1 x Metal stand.		



Pin Punch Set Metric

Chrome vanadium steel, mirror polished. Supplied in compact plastic holder.

Part No.	Qty	Description
TL4100	1 Set	6 Piece Set
6 x Sizes: 2, 3, 4, 5, 6, 8 mm.		



TENG TOOLS Heavy Duty Pry Bar Set

With 'Power Thru' handles.

Part No.	Qty	Description
TTXPB3A	1 Set	3 Piece Set
3 x Sizes: 12", 18", 22".		

Brass Drifts - Imperial

Supplied in a wooden storage block.

Part No.	Qty	Description
TNKBD3	1 Set	5 Piece Set
5 x Sizes, Diameters: 1/4", 3/8", 1/2", 5/8", 3/4".		



BEST SELLER





MAYHEW Punch & Chisel Set

Supplied in a storage roll.

Part No.	Qty	Description
TN7014K	1 Set	14 Piece Set

1 x Centre Punch: 3/8" x 5". 2 x Taper Punches: 1/8", 3/16". 5 x Pin Punches: 3/32", 1/8", 5/32", 3/16", 1/4". 1 x Line-up Punch: 1/8". 5 x Cold Chisels, Standard Length: 1/4", 3/8", 1/2", 5/8", 3/4".



MAYHEW Cold Chisel Set - Standard Sizes

Supplied in a storage roll.

Part No.	Qty	Description
TN7001K	1 Set	6 Piece Set

6 x Sizes: 1/4" x 5", 5/16" x 5", 3/8" x 5 1/2", 1/2" x 6", 5/8" x 6 1/2", 3/4" x 7".



MAYHEW Roll Pin (Pilot) Punch Set

Supplied in a storage roll.

Part No.	Qty	Description
TN106KM	1 Set	6 Piece Set

Sizes: 3, 4, 5, 6, 7, 8 mm.



MAYHEW Pin Punches - Standard Sizes

Supplied in a storage roll.

Part No.	Qty	Description
TN4101KM	1 Set	6 Piece Set

6 x Sizes: 3, 4, 5, 6, 7, 8 mm.



TRIDENT Long Chisel Set - Metric Sizes

Chrome-molybdenum steel, mirror polished. Supplied in storage roll.

Part No.	Qty	Description
TL4102	1 Set	4 Piece Set

4 x Sizes: 350 mm x 12, 16, 19, 22 mm.



TRIDENT Long Pin Punch Set - Metric Sizes

Chrome-molybdenum steel, mirror polished. Supplied in storage roll.

Part No.	Qty	Description
TL4104	1 Set	6 Piece Set

6 x Sizes: 200 mm x 2, 3, 4, 5, 6, 8 mm.



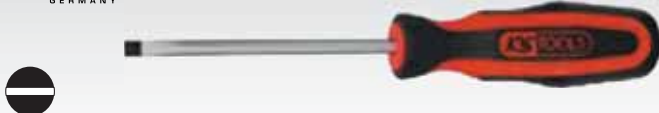

**KS TOOLS 'ERGOTORQUEplus'®
Screwdrivers - Slotted**

DIN 5265. S2 steel hardened blade, chrome finished with burnished tips. Ergonomic non-slip 2-component handle.

Part No.	Qty	Tip Width	Shaft Length	Hex Drive
K159.1002	1	3.0 mm	75 mm	-
K159.1003	1	4.0 mm	75 mm	-
K159.1004	1	4.0 mm	100 mm	-
K159.1005	1	5.5 mm	100 mm	-
K159.1006	1	5.5 mm	125 mm	-
K159.1007	1	5.5 mm	150 mm	-
K159.1008	1	6.5 mm	125 mm	-
K159.1009	1	6.5 mm	150 mm	M10
K159.1010	1	8.0 mm	150 mm	M10
K159.1011	1	8.0 mm	200 mm	M10
K159.1012	1	10.0 mm	200 mm	M10
K159.1013	1	10.0 mm	250 mm	M10



**KS TOOLS 'ERGOTORQUEplus'®
Stubby Screwdriver - Slotted**

DIN 5265. S2 steel hardened blade, chrome finished with burnished tips. Ergonomic non-slip 2-component handle.

Part No.	Qty	Tip Width	Shaft Length
K159.1001	1	6.0 mm	38 mm

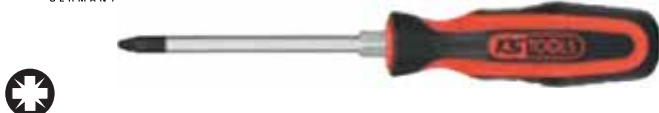

**KS TOOLS 'ERGOTORQUEplus'®
Screwdriver - POZIDRIV®**

DIN/ISO 8764. S2 steel hardened blade, chrome finished with burnished tips. Ergonomic non-slip 2-component handle.

Part No.	Qty	Tip No.	Shaft Length	Hex Drive
K159.1047	1	PZ0	75 mm	-
K159.1040	1	PZ1	75 mm	-
K159.1049	1	PZ1	100 mm	-
K159.1041	1	PZ2	100 mm	M10
K159.1042	1	PZ2	125 mm	M10
K159.1043	1	PZ2	150 mm	M10
K159.1048	1	PZ2	200 mm	M10
K159.1044	1	PZ3	150 mm	M10
K159.1045	1	PZ3	200 mm	M10



**KS TOOLS 'ERGOTORQUEplus'®
Stubby Screwdriver - POZIDRIV®**

DIN/ISO 8764. S2 steel hardened blade, chrome finished with burnished tips. Ergonomic non-slip 2-component handle.

Part No.	Qty	Tip No.	Shaft Length
K159.1046	1	PZ2	38 mm



**KS TOOLS 'ERGOTORQUEplus'®
Screwdriver - PHILIPS®**

DIN/ISO 8164. S2 steel hardened blade, chrome finished with burnished tips. Ergonomic non-slip 2-component handle.

Part No.	Qty	Tip No.	Shaft Length	Hex Drive
K159.1027	1	PH0	75 mm	-
K159.1020	1	PH1	75 mm	-
K159.1029	1	PH1	100 mm	-
K159.1021	1	PH2	100 mm	M10
K159.1022	1	PH2	125 mm	M10
K159.1023	1	PH2	150 mm	M10
K159.1028	1	PH2	200 mm	M10
K159.1024	1	PH3	150 mm	M10
K159.1025	1	PH3	200 mm	M10



**KS TOOLS 'ERGOTORQUEplus'®
Stubby Screwdriver - PHILIPS®**

DIN/ISO 8164. S2 steel hardened blade, chrome finished with burnished tips. Ergonomic non-slip 2-component handle.

Part No.	Qty	Tip No.	Shaft Length	Hex Drive
K159.1026	1	PH2	38 mm	M10

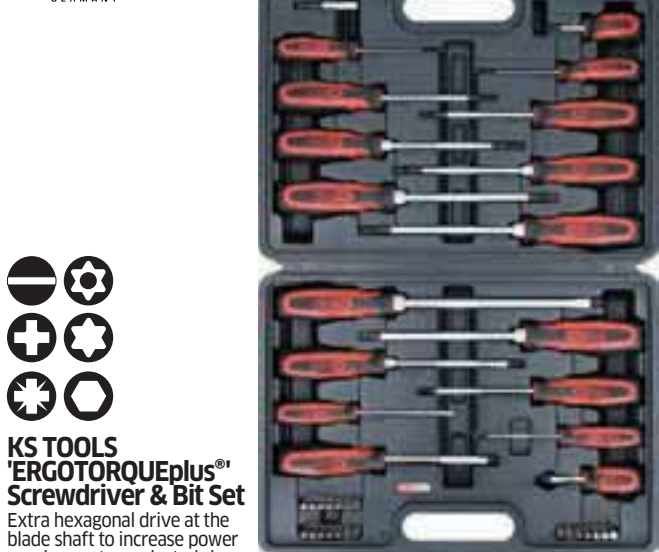

**KS TOOLS
'ERGOTORQUEplus'®
Screwdriver & Bit Set**

Extra hexagonal drive at the blade shaft to increase power requirement on selected sizes. DIN 5264, DIN 5265, DIN/ISO 8764. Ergonomic non-slip 2 component handle. Supplied in a robust plastic storage case.

Part No.	Qty	Description
K159.0100	1 Set	39 Piece Set
7 x Slotted screwdrivers: 3 x 75 mm, 4 x 100 mm, 5.5 x 100 mm, stubby 6 x 38 mm, 6.5 x 125 mm, 8 x 150 mm, 10 x 200 mm.		
5 x PHILLIPS' screwdrivers: PH0 x 75 mm, PH1 x 100 mm, PH2 x 125 mm, stubby PH2 x 38 mm, PH3 x 150 mm.		
4 x POZIDRIV' screwdrivers: PZ0 x 75 mm, PZ1 x 100 mm, PZ2 x 125 mm, PZ3 x 150 mm.		
1 x Bit screwdriver, magnetic, 1/4": 100 mm. 1 x Bit drive, magnetic, 1/4": 60 mm. 21 x Bits, 1/4", 25 mm:		
7 x Hexagonal: 2, 2.5, 3, 4, 5, 6, 8 mm. 7 x TORX: T10, T15, T20, T25, T27, T30, T40.		
7 x Tamper Proof TORX: TP10, TP15, TP20, TP25, TP27, TP30, TP40.		



**KS TOOLS 'ERGOTORQUEplus®
Screwdriver - Tamper Proof TORX®**

DIN 5264, DIN 5265, DIN/ISO 8764. S2 steel hardened blade, chrome finished with burnished tips. Ergonomic non-slip 2-component handle.

Part No.	Qty	Tip No.	Shaft Length	Hex Drive
K159.1050	1	TP8	100 mm	-
K159.1051	1	TP9	100 mm	-
K159.1052	1	TP10	100 mm	-
K159.1053	1	TP15	100 mm	M10
K159.1054	1	TP20	100 mm	M10
K159.1055	1	TP25	100 mm	M10
K159.1056	1	TP27	100 mm	M10
K159.1057	1	TP30	100 mm	M10
K159.1058	1	TP40	100 mm	M10



**KS TOOLS 'ERGOTORQUEplus®
Screwdriver - TORX®**

DIN 5264, DIN 5265, DIN/ISO 8764. S2 steel hardened blade, chrome finished with burnished tips. Ergonomic non-slip 2-component handle.

Part No.	Qty	Tip No.	Shaft Length	Hex Drive
K159.1030	1	T8	100 mm	-
K159.1031	1	T9	100 mm	-
K159.1032	1	T10	100 mm	-
K159.1033	1	T15	100 mm	M10
K159.1034	1	T20	100 mm	M10
K159.1035	1	T25	100 mm	M10
K159.1036	1	T27	100 mm	M10
K159.1037	1	T30	100 mm	M10
K159.1038	1	T40	100 mm	M10



**KS TOOLS 'ERGOTORQUEplus®
Tamper Proof TORX® Screwdriver Set**

DIN 5264, DIN 5265, DIN/ISO 8764. Ergonomic non-slip 2 component handle. Supplied in a display box.

Part No.	Qty	Description
K159.0040	1 Set	6 Piece Set

6 x Tamper Proof TORX® screwdrivers: TP10, TP15, TP20, TP25, TP30, TP40 x 100 mm.



**KS TOOLS 'ERGOTORQUEplus®
TORX® Screwdriver Set**

DIN 5264, DIN 5265, DIN/ISO 8764. Ergonomic non-slip 2 component handle. Supplied in a display box.

Part No.	Qty	Description
K159.0030	1 Set	6 Piece Set

6 x TORX® screwdrivers: T10, T15, T20, T25, T30, T40 x 100 mm.



**KS TOOLS 'ERGOTORQUEmax®
Impact Screwdriver Set**

Impact head with 1/4" female hex drive. DIN 5264, DIN 5265, DIN/ISO 8764. Ergonomic non-slip 2 Component handle. Supplied in a display box

- Includes 45 teeth 1/4" T-Grip ratchet, 3 positions: Left/Fixed/Right
- Through connection from impact head to shaft.

Part No.	Qty	Description
K151.1100	1 Set	7 Piece Set

4 x Slotted screwdrivers: 3.5, 4.5, 5.5, 7 mm.
2 x PHILLIPS® screwdrivers: PH1, PH2. 1 x T-Grip ratchet, 1/4".



**KS TOOLS 'ERGOTORQUEplus®
Slotted & POZIDRIV® Screwdriver Set**

Extra hexagonal drive at the blade shaft to increase power requirement on selected sizes. DIN 5264, DIN 5265, DIN/ISO 8764. Ergonomic non-slip 2 component handle. Supplied in a display box.

Part No.	Qty	Description
K159.0020	1 Set	6 Piece Set

4 x Slotted screwdrivers: 3 x 75 mm, 4 x 100 mm, 5.5 x 125 mm, 6.5 x 150 mm.
2 x POZIDRIV® screwdrivers: PZ 1 x 75 mm, PZ 2 x 100 mm.





NWS VDE Screwdriver - Slotted

DIN 7437 / 7348. Insulation to IEC 60900 1,000V. Black finish alloy hardened special steel blade. 2-component handle with hanging hole.

Part No.	Qty	Tip Width x Height	Shaft Length
TNS120	1	3.5 x 0.6 mm	100 mm
TNS130	1	4.0 x 0.8 mm	100 mm
TNS140	1	5.5 x 1.0 mm	125 mm
TNS150	1	6.5 x 1.2 mm	150 mm



NWS VDE Screwdriver - PH

DIN 7437 / 7348. Insulation to IEC 60900 1,000 V. Black finish alloy hardened special steel blade. 2-component handle with hanging hole.

Part No.	Qty	Tip No.	Shaft Length
TNS200	1	PH0	60 mm
TNS210	1	PH1	80 mm
TNS220	1	PH2	100 mm



NWS VDE Screwdriver - PZ

DIN 7437 / 7348. Insulation to IEC 60900 1,000 V. Black finish alloy hardened special steel blade. 2-component handle with hanging hole.

Part No.	Qty	Tip No.	Shaft Length
TNS300	1	PZ0	60 mm
TNS310	1	PZ1	80 mm
TNS320	1	PZ2	100 mm



BONDHUS 6 Piece VDE Screwdriver Set

Rated for use to 1,000V, tested at 10,000V. Chrome-vanadium-molybdenum blades for hardness and high torque applications.

- Comfort grip
- VDE Approved

Part No.	Qty	Description
TL1008	1 Set	6 Piece Set

SL 75 x 2.5 mm, SL 100 x 3.5 mm, SL 125 x 4.5 mm, PZ No. 1 x 80 mm, PZ No. 2 x 100 mm, Volt Tester 60 x 3 mm.



NWS VDE Screwdriver Set - Slotted & PH

DIN 7437 / 7348. Insulation to IEC 60900 1,000 V. Black finish alloy hardened special steel blade. 2-component handle with hanging hole.

Part No.	Qty	Description
TNS500	1 Set	5 Piece Set

4 x Slotted (width x shaft length): 2.5 x 75, 4.0 x 100, 5.5 x 125 mm.
1 x PH Head (PH No.x shaft length): PH1 x 80 mm.
1 x Voltage Tester, GS tested for 120-250V AC: 65 mm blade length.



NWS VDE Screwdriver Set - Slotted & PH

DIN 7437 / 7348. Insulation to IEC 60900 1,000 V. Black finish alloy hardened special steel blade. 2-component handle with hanging hole.

Part No.	Qty	Description
TNS700	1 Set	7 Piece Set

4 x Slotted (width x shaft length): 2.5 x 75, 4.0 x 100, 5.5 x 125, 6.5 mm.
2 x PH Head (PH No.x shaft length): PH0 x 60 mm, PH1 x 80 mm.
1 x Voltage Tester, GS tested for 120-250V AC: 65 mm blade length.



SPEAR & JACKSON Pocket Screwdrivers

Complete with pocket clip.

Part No.	Pack of	Tip Width	Shaft Length
TL151	6	3 mm	50 mm



BEST SELLER



BONDHUS 3 Piece VDE Screwdriver Set

Rated for use to 1,000V, tested at 10,000V. Chrome-vanadium-molybdenum blades for hardness and high torque applications.

- Comfort grip
- VDE Approved

Part No.	Qty	Description
TL1009	1 Set	3 Piece Set

SL 75 x 2.5 mm, SL 100 x 4.0 mm, PZ No. 1 x 80 mm.





TENG TOOLS 'Mega Drive' Screwdrivers - Slotted

DIN 5264.

Part No.	Qty	Tip Width	Shaft Length
TMD920	1	3.0 mm	75 mm
TMD921	1	3.0 mm	100 mm
TMD922	1	5.5 mm	75 mm
TMD923	1	5.5 mm	150 mm
TMD928	1	6.5 mm	38 mm Stubby Type
TMD933	1	6.5 mm	150 mm
TMD691	1	6.5 mm	400 mm Long Series
TMD934	1	8.0 mm	150 mm



TENG TOOLS 'Mega Drive' Screwdrivers - PZ

Part No.	Qty	Tip Size	Shaft Length
TMD960	1	PZ0	75 mm
TMD961	1	PZ1	75 mm
TMD972	1	PZ2	100 mm
TMD973	1	PZ3	150 mm



TENG TOOLS 'Mega Drive' Screwdrivers - PH

DIN 5260.

Part No.	Qty	Tip Size	Shaft Length
TMD940	1	PH0	75 mm
TMD941	1	PH1	75 mm
TMD948	1	PH2	38 mm Stubby Type
TMD952	1	PH2	100 mm
TMD692	1	PH2	400 mm Long Series
TMD953	1	PH3	150 mm



TENG TOOLS 'Mega Drive' Screwdriver Set

Supplied in a tool tray.

Part No.	Qty	Description
TTT917N	1 Set	7 Piece Set

3 x Slotted: 3 x 75 mm, 5 x 75 mm, 6 x 100 mm. 3 x PH: PH0 x 75 mm, PH1 x 75 mm, PH2 x 100 mm.
1 x PZ: PZ2 x 100 mm



TENG TOOLS 'Mega Drive' Screwdriver Set

Supplied in a plastic storage case.

Part No.	Qty	Description
TMD912N	1 Set	12 Piece Set

6 x Slotted: 2.5 x 75 mm, 3.5 x 100 mm, 4.0 x 150 mm, 5.5 x 150 mm, 6.5 x 150 mm, 10 x 200 mm.
4 x PH: PH0 x 75 mm, PH1 x 75 mm, PH2 x 100 mm, PH2 x 200 mm.
2 x PZ: PZ1 x 75 mm, PZ2 x 100 mm.



KS TOOLS Precision Screwdriver Set

2 component handle with twist cap. High quality S2 steel. Shaft Length: 50 mm.

Part No.	Qty	Description
K500.7170	1 Set	14 Piece Set

4 x Slotted: 1.4, 2, 2.5, 3 mm.
3 x PHILLIPS: PH00 x 2, PH0 x 2.4, PH1 x 3 mm Shaft Ø
7 x TORX: T6, T7, T8, T9, T10, T15, T20.



TENG TOOLS 'Mega Drive' TX/TPX Screwdriver Set

Supplied in a tool tray.

Part No.	Qty	Description
TTT917TXN	1 Set	7 Piece Set

2 x TX, 75 mm: TX8, TX9, 5 x TPX, 100 mm: TPX10, TPX15, TPX20, TPX25, TPX30.



1/4" Hex Bits POZI

Part No.	Pack of	Size
TNBZ1	5	No.1 Tip
TNBZ2	5	No.2 Tip
TNBZ3	5	No.3 Tip



KS TOOLS 'TORSIONpower' 1/4" Dr. - Slotted

High quality S2 steel, bright nickel plated. Length: 25 mm. DIN 3126 / ISO 1173.

Part No.	Pack of	Size	Colour
K918.3306	5	3 mm	Orange
K918.3311	5	4 mm	Orange
K918.3316	5	5 mm	Orange
K918.3321	5	6 mm	Orange



KS TOOLS 'TORSIONpower' 1/4" Dr. - POZIDRIV®

High quality S2 steel, bright nickel plated. Length: 25 mm. DIN 3126 / ISO 1173.

Part No.	Pack of	Size	Colour
K918.3206	5	PZ1	Blue
K918.3211	5	PZ2	Blue
K918.3216	5	PZ3	Blue



KS TOOLS 'TORSIONpower' 1/4" Dr. - PHILLIPS®

High quality S2 steel, bright nickel plated. Length: 25 mm. DIN 3126 / ISO 1173.

Part No.	Pack of	Size	Colour
K918.3106	5	PH1	Red
K918.3111	5	PH2	Red
K918.3116	5	PH3	Red



KS TOOLS 'TORSIONpower' 1/4" Dr. - Hexagonal

High quality S2 steel, bright nickel plated. Length: 25 mm. DIN 3126 / ISO 1173.

Part No.	Pack of	Size	Colour
K918.3406	5	3 mm	Dark Yellow
K918.3411	5	4 mm	Dark Yellow
K918.3416	5	5 mm	Dark Yellow
K918.3421	5	6 mm	Dark Yellow



KS TOOLS 'TORSIONpower' 1/4" Dr. - Tamper Proof TORX®

High quality S2 steel, bright nickel plated. Length: 25 mm. DIN 3126 / ISO 1173.

Part No.	Pack of	Size	Colour
K918.3606	5	TP10	Violet
K918.3611	5	TP15	Violet
K918.3616	5	TP20	Violet
K918.3621	5	TP25	Violet
K918.3626	5	TP27	Violet
K918.3631	5	TP30	Violet
K918.3636	5	TP40	Violet



KS TOOLS 'TORSIONpower' 1/4" Dr. - TORX®

High quality S2 steel, bright nickel plated. Length: 25 mm. DIN 3126 / ISO 1173.

Part No.	Pack of	Size	Colour
K918.3506	5	T10	Light Yellow
K918.3511	5	T15	Light Yellow
K918.3516	5	T20	Light Yellow
K918.3521	5	T25	Light Yellow
K918.3526	5	T27	Light Yellow
K918.3531	5	T30	Light Yellow
K918.3536	5	T40	Light Yellow



KS TOOLS 'TORSIONpower' 1/4" Bit Set

High quality S2 steel, bright nickel plated. Bits manufactured to DIN3126 / ISO 1173. Supplied in durable storage case with belt clip.

Part No.	Qty	Description
K918.3010	1 Set	32 Piece Set

1 x Auto slimlock bit holder, 1/4" 65 mm. 1 x 1/4" bit reversing ratchet set (2 pieces). 30 x Bits 1/4" 25 mm:
 4 x Slotted: 3, 4, 5, 6 mm. 4 x PHILLIPS: PH 1, PH 2 (x 2), PH 3. 4 x POZIDRIV®: PZ1, PZ 2 (x 2), PZ 3.
 4 x Hexagonal: 3, 4, 5, 6 mm. 7 x TORX: T10, T15, T20, T25, T27, T30, T40.
 7 x Tamper Proof TORX: TP10, TP15, TP20, TP25, TP27, TP30, TP40.



KS TOOLS 'Auto-Slimlock' 1/4" Dr. Automatic Magnetic Bit Holder

Finest chrome vanadium steel. Length: 65 mm.

- Extremely slim profile allowing access to very small diameter holes (11.5 mm)

Part No.	Qty	Description
K514.1113	1	Automatic Bit Holder



**KS TOOLS
1/4\"/>**

High quality S2 steel, nickel plated.
Supplied in a robust plastic storage case.

Part No.	Qty	Description
----------	-----	-------------

K911.2027 1 Set **99 Piece Set**

1 x Bit holder, 1/4" magnetic: 60 mm. 1 x Socket adaptor: 1/4" square x 1/4" hex drive. 1 x Bit adaptor socket 1/4" 79 x Bits 1/4", 25 mm: 9 x Slotted: 3, 4, 4.5, 5, 5.5, 6, 6.5, 7, 8 mm. 5 x PHILLIPS: PH0, PH1, PH2 (x 2), PH3. 5 x POZIDRIV: PZ0, PZ1, PZ2 (x 2), PZ3. 9 x Hexagonal: 1.5, 2, 2.5, 3, 4, 5, 5.5, 6, 8 mm. 12 x Hexagonal: 2, 2.5, 3, 4, 5, 6 mm. 5/64", 3/32", 7/64", 1/8", 9/64", 5/32". 9 x TORX: T8, T10, T15, T20, T25, T27, T30, T40, T45. 9 x Tamper Proof TORX: TP8, TP10, TP15, TP20, TP25, TP27, TP30, TP35, TP40. 3 x Spline (XZN): M5, M6, M8. 3 x Dual Wedge: 1, 2, 3, 4 x Tri-Wing: 1, 2, 3, 4 x Spanner: 4, 6, 8, 10. 3 x Torque: 6, 8, 10 mm. 4 x Square: 0, 1, 2, 3. 17 x Bit 1/4", 75 mm: 3 x Hexagonal: 4, 5, 6 mm. 3 x Tamper Proof TORX: TP15, TP20, TP30. 4 x Tri-Wing: 1, 2, 3, 4. 4 x Spanner: 4, 6, 8, 10. 3 x Torque: 6, 8, 10 mm.



TENG TOOLS Bits Set

Supplied in a plastic storage case.

Part No.	Qty	Description
----------	-----	-------------

TTM029 1 Set **29 Piece Set**

1 x Bits ratchet, 1/4" with 8 mm ring spanner. 1 x Bit holder, 1/4" magnetic: 50 mm. 27 x Bits 1/4", 25 mm: 3 x Flat: 0.6 x 4.5 mm, 0.8 x 5.5 mm, 1.2 x 6.5 mm. 3 x PH: PH1, PH2, PH3. 3 x PZ: PZ1, PZ2, PZ3. 6 x TX: TX10, TX15, TX20, TX25, TX30, TX40. 3 x TPX: TPX20, TPX25, TPX30. 3 x ROB: No. 1, 2, 3. 3 x Hex: 4, 5, 6 mm. 2 x Grabber: No. 2. 1 x Square Adaptor: 1/4".



**TRIDENT
1/4\"/>**

Chromium-vanadium steel bits.
Supplied in robust storage case.
Dimensions: 195 x 135 x 37 mm.

Part No.	Qty	Description
----------	-----	-------------

TL1100 1 Set **100 Piece Set**

1 x Bit Holder, 1/4" magnetic: 60 mm. 1 x Bit Adaptor Socket, 1/4". 1 x Cup Hook Y-Adaptor: 1/4" Hex. 2 x Socket Adaptors, 1/4" Sq x 1/4" Hex Dr: 25 mm, 50 mm. 95 x 1/4" Bits, 25 mm: 9 x Tamper Proof TX: TP8, TP10, TP15, TP20, TP25, TP27, TP30, TP35, TP40. 9 x TX: T8, T10, T15, T20, T25, T27, T30, T35, T40. 3 x Clutch: 1, 2, 3. 3 x Torq: 1, 2, 3. 3 x Spline: M5, M6, M8. 4 x Tri-Wing: 1, 2, 3, 4 x Square: 0, 1, 2, 3. 4 x Spanner: 4, 6, 8, 10. 9 x Flat: 3, 4, 4.5, 5, 5.5, 6, 6.5, 7, 8 mm. 8 x PH: PH0, PH1, PH2 (x 5), PH3. 8 x PZ: PZ0, PZ1, PZ2 (x 5), PZ3. 10 x Hex, Imperial: 1/16", 5/64", 3/32", 7/64", 1/8", 9/64", 5/32", 3/16", 7/32", 1/4". 6 x Tamper Proof Hex, Imperial: 5/64", 3/32", 7/64", 1/8", 9/64", 5/32". 9 x Hex, Metric: 1.5, 2, 2.5, 3, 4, 5, 5.5, 6, 8 mm. 6 x Tamper Proof Hex, Metric: 2, 2.5, 3, 4, 5, 6 mm.



LASER 1/4\"/>

Complete with magnetic bit holder
Supplied in a robust rubber organiser.

Part No.	Qty	Description
----------	-----	-------------

TL474 1 Set **33 Piece Set**

1 x Bit holder, 1/4" magnetic: 60 mm. 32 x Bits 1/4", 25 mm: 5 x Slotted: 3, 4, 5, 6, 7 mm. 9 x Phillips: PH0, PH1 (x 2), PH2 (x 3), PH2 (x 3). 7 x Pozidriv: PZ1 (x 2), PZ2 (x 3), PZ3 (x 2). 6 x Hex: 2, 2.5, 3, 4, 5, 6 mm. 6 x Star (TX): T10, T15, T20, T25, T30, T40.

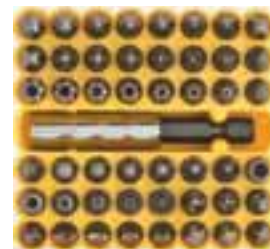

LASER 1/4\"/>

Complete with magnetic bit holder.
Supplied in a robust rubber organiser.

Part No.	Qty	Description
----------	-----	-------------

TL479 1 Set **49 Piece Set**

1 x Bit holder, 1/4" magnetic: 60 mm. 48 x Bits 1/4", 25 mm: 3 x Torq: 6, 8, 10 mm. 4 x Spanner Bits: 4, 6, 8, 10 mm. 4 x Tri-Wing: 1, 2, 3, 4 mm. 6 x Tamper Proof Hex: 2, 2.5, 3, 4, 5, 6 mm. 6 x Hex: 5/32", 9/64", 1/8", 7/64", 3/32", 5/64". 7 x Pozidriv: 1 (x 2), 2 (x 3), 3 (x 2). 9 x Phillips: 0, 1 (x 3), 2 (x 3), 3 (x 2). 9 x Tamper Proof Star (TPX): T8H, T10H, T15H, T20H, T25H, T27H, T30H, T35H, T40H.



**KS TOOLS
10 mm Dr.
Hex Bit Socket Adaptor**

Finest chrome vanadium steel.
Complete with retaining clip.

Part No.	Qty	Drive Size
----------	-----	------------

K911.4312 1 **1/2" Drive**



**KS TOOLS
10 mm Dr.
Long Bits - TORX®**

Finest chrome vanadium steel.
Length: 75 mm.

Part No.	Qty	Size
----------	-----	------

K975.2020 1 **T20**

K975.2025 1 **T25**

K975.2027 1 **T27**

K975.2030 1 **T30**

K975.2040 1 **T40**

K975.2045 1 **T45**

K975.2050 1 **T50**

K975.2055 1 **T55**

K975.2060 1 **T60**





BONDHUS Balldriver Hex T-Handle - Metric

Protanium® High Torque Steel with ProGuard dry finish for superior corrosion protection. Cushioned curved ergonomic form-fitting solid steel handle.

Part No.	Qty	Size	Length
TL13160	1	4 mm	220 mm
TL13164	1	5 mm	246 mm
TL13168	1	6 mm	266 mm
TL13172	1	8 mm	285 mm
TL13176	1	10 mm	307 mm



BONDHUS Balldriver Hex T-Handle - Imperial

Protanium® High Torque Steel with ProGuard dry finish for superior corrosion protection. Cushioned curved ergonomic form-fitting solid steel handle.

Part No.	Qty	Size	Length
TL13109	1	5/32"	231 mm
TL13110	1	3/16"	250 mm
TL13111	1	7/32"	262 mm
TL13112	1	1/4"	275 mm
TL13113	1	5/16"	289 mm
TL13114	1	3/8"	300 mm



BONDHUS Balldriver/Hex T-Handles - Metric Set

Supplied in durable storage pouch.

Part No.	Qty	Description
TL349	1 Set	8 Piece Set

3 x Hex Sizes: 2, 2.5, 3, 5 x Balldriver Sizes: 4, 5, 6, 8, 10 mm.



BONDHUS Balldriver T-Handle Set - Imperial

Supplied in durable storage pouch.

Part No.	Qty	Description
TL352	1 Set	6 Piece Set

8 x Sizes: 5/32", 3/16", 7/32", 1/4", 5/16", 3/8".

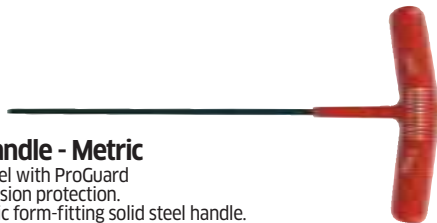

BONDHUS Hex T-Handle - Metric

Protanium® High Torque Steel with ProGuard dry finish for superior corrosion protection. Cushioned curved ergonomic form-fitting solid steel handle.

Part No.	Qty	Size	Length
TL13252	1	2 mm	150 mm
TL13352	1	2 mm	100 mm
TL13254	1	2.5 mm	172 mm
TL13354	1	2.5 mm	110 mm
TL13256	1	3 mm	196 mm
TL13356	1	3 mm	120 mm
TL13360	1	4 mm	136 mm
TL13364	1	5 mm	150 mm
TL13368	1	6 mm	173 mm
TL13372	1	8 mm	202 mm
TL13376	1	10 mm	232 mm



BONDHUS TORX® T-Handle

Protanium® High Torque Steel with ProGuard dry finish for superior corrosion protection. Cushioned curved ergonomic form-fitting solid steel handle.

Part No.	Qty	Size	Length
TL33009	1	T9	155 mm
TL33010	1	T10	161 mm
TL33015	1	T15	168 mm
TL33020	1	T20	174 mm
TL33025	1	T25	180 mm
TL33027	1	T27	187 mm
TL33030	1	T30	193 mm
TL33040	1	T40	199 mm



BONDHUS Hex T-Handles - Metric Set

Supplied in durable storage pouch.

Part No.	Qty	Description
TL350	1 Set	8 Piece Set

8 x Sizes: 2, 2.5, 3, 4, 5, 6, 8, 10 mm.

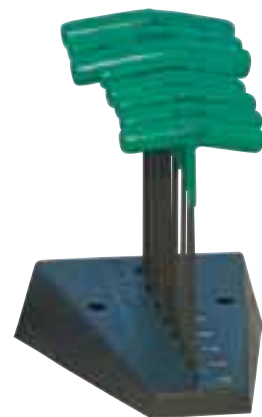

BONDHUS Star T-Handles - TX Set

Supplied with plastic wall mountable stand.

Part No.	Qty	Description
TL348	1 Set	8 Piece Set

8 x Sizes: T9, T10, T15, T20, T25, T27, T30, T40.



BONDHUS Balldriver/Hex T-Handles - Imperial Set

Supplied with plastic wall mountable stand.

Part No.	Qty	Description
TL351	1 Set	10 Piece Set

4 x Hex Sizes: 3/32", 7/64", 1/8", 9/64". 6 x Balldriver Sizes: 5/32", 3/16", 7/32", 1/4", 5/16", 3/8"



TENG TOOLS T-Handle Hex Drivers Set

Ball point head on long hex keys. Supplied in a tool tray.

Part No.	Qty	Description
TTTTEX7	1 Set	7 Piece Set

3 x Hex, 100 mm: 2.5, 3, 4 mm. 3 x Hex, 150 mm: 5, 6, 7 mm. 1 x Hex, 190 mm: 8 mm



TENG TOOLS T-Handle TX/TPX Drivers Set

Supplied in a tool tray.

Part No.	Qty	Description
TTTTX7	1 Set	7 Piece Set

3 x TX, 100 mm: TX/TPX10, TX/TPX15, TX/TPX20. 3 x TX, 150 mm: TX/TPX25, TX/TPX27, TX/TPX30. 1 x TX, 190 mm: TX/TPX40

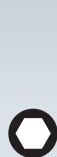

BONDHUS 'HEX PRO' Pivot Head Wrenches - Metric Set

Insert wrench just once and simply pivot around obstacles, long handles for extra reach. Supplied in a canvas roll pouch.

Part No.	Qty	Description
TL357	1 Set	6 Piece Set

6 x Hex Sizes: 3, 4, 5, 6, 8, 10 mm

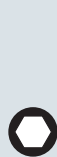

BONDHUS 'HEX PRO' Pivot Head Wrenches - Imperial Set

Insert wrench just once and simply pivot around obstacles, long handles for extra reach. Supplied in a canvas roll pouch.

Part No.	Qty	Description
TL358	1 Set	8 Piece Set

8 x Hex Sizes: 1/8", 9/64", 5/32", 3/16", 7/32", 1/4", 5/16", 3/8"

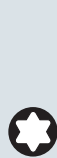

BONDHUS 'TORX PRO' Pivot Head Wrenches

Insert wrench just once and simply pivot around obstacles, long handles for extra reach. Supplied in a canvas roll pouch.

Part No.	Qty	Description
TL359	1 Set	6 Piece Set

6 x TORX Sizes: T25, T27, T30, T40, T45, T50





BONDHUS Hex Driver Fold Up Set - Metric

Part No.	Qty	Description
TNB12595	1 Set	6 Piece Set

6 x Sizes: 3, 4, 5, 6, 8, 10 mm.



BONDHUS Ball Hex Driver Set - Imperial

Part No.	Qty	Description
TL346	1 Set	13 Piece Set

13 x Hex Sizes: .050", 1/16", 5/64", 3/32", 7/64", 1/8", 9/64", 5/32", 3/16", 7/32", 1/4", 5/16", 3/8".



BONDHUS 'GorillaGrip' Hex Driver Fold Up Set - Metric

Part No.	Qty	Description
TNB12592	1 Set	7 Piece Set

7 x Sizes: 1.5, 2, 2.5, 3, 4, 5, 6 mm.



BONDHUS Stubby Ball Hex Key Wrench Set - Imperial

Part No.	Qty	Description
TL354	1 Set	13 Piece Set

13 x Hex Sizes: .050, 1/16", 5/64", 3/32", 7/64", 1/8", 9/64", 5/32", 3/16", 7/32", 1/4", 5/16", 3/8".



90° stop converts the tool into a non-stop, time saving, speed wrench



'Turn & Flip' feature eliminates constant removal and repositioning in screw head when working against obstructions.



BONDHUS Ball Hex Driver Set - Metric

Part No.	Qty	Description
TL345	1 Set	9 Piece Set

Sizes: 1.5, 2, 2.5, 3, 4, 5, 6, 8, 10 mm.



BONDHUS 'GorillaGrip' TORX® Driver Fold Up Set

Part No.	Qty	Description
TNB12632	1 Set	8 Piece Set

8 x Sizes: T6, T7, T8, T9, T10, T15, T20, T25.



BONDHUS Stubby Ball Hex Key Wrench Set - Metric

Part No.	Qty	Description
TL353	1 Set	9 Piece Set

9 x Hex Sizes: 1.5, 2, 2.5, 3, 4, 5, 6, 8, 10 mm.

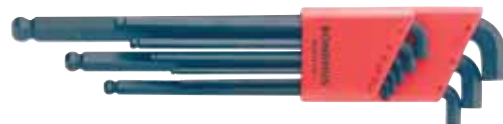

BONDHUS TORX® Driver Fold Up Set

Part No.	Qty	Description
TNB12634	1 Set	8 Piece Set

8 x Sizes: T9, T10, T15, T20, T25, T27, T30, T40.



BONDHUS BALLSTAR® Driver Set - TORX® Set

Part No.	Qty	Description
TL347	1 Set	8 Piece Set

8 x TORX® Sizes: T9, T10, T15, T20, T25, T27, T30, T40.

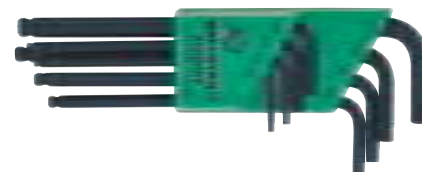



BONDHUS Ball Hex Driver Sets - Metric & Imperial Twin Pack

Part No. Qty Description

TNB20199 Set of 2 **Ball Hex Twin Pack**

9 x Hex Sizes: 1.5, 2, 2.5, 3, 4, 5, 6, 8, 10 mm.
13 x Hex Sizes: .050", 1/16", 5/64", 3/32", 7/64", 1/8", 9/64", 5/32", 3/16", 7/32", 1/4", 5/16", 3/8".



BONDHUS Colour Coded Ball End Hex Key Wrenches - Metric Set

Part No. Qty Description

TNB69499 1 Set **9 Piece Set**

9 x Hex Sizes: 1.5, 2, 2.5, 3, 4, 5, 6, 8, 10 mm.



BONDHUS Colour Coded Ball End Hex Key Wrenches - Extra Long Metric Set

Part No. Qty Description

TNB69699 1 Set **9 Piece Set**

9 x Hex Sizes: 1.5, 2, 2.5, 3, 4, 5, 6, 8, 10 mm.



TENG TOOLS Ball Point Hex Key Wrench Set - Metric

Black finish. Supplied in a folding holder.

Part No. Qty Description

T1479MMA 1 Set **9 Piece Set**

9 x Sizes: 1.5, 2.0, 2.5, 3.0, 4.0, 5.0, 6.0, 7.0, 10.0 mm.



TENG TOOLS Ball Point Hex Key Wrench Set - Imperial

Black finish. Supplied in a folding holder.

Part No. Qty Description

T1479AF 1 Set **9 Piece Set**

9 x Sizes: 5/64", 3/32", 1/8", 5/32", 3/16", 7/32", 1/4", 5/16", 3/8".



TENG TOOLS TX Key Wrench Set

Black finish. Supplied in a folding holder.

Part No. Qty Description

T1479TX 1 Set **9 Piece Set**

9 x TX Keys: TX8, TX9, TX10, TX15, TX20, TX25, TX27, TX30, TX40.



KS TOOLS 3-in-1 Hex Key Wrench Set, Ball Ended

Chrome plated, matt finish. DIN/ISO 2936. In patented plastic holder.

Part No. Qty Description

K151.2100 1 Set **8 Piece Set**

8 x Sizes: 2, 2.5, 3, 4, 5, 6, 8, 10 mm.



KS TOOLS 3-in-1 Hex Key Wrench Set, Extra Long Ball Ended

Chrome plated, matt finish. DIN/ISO 2936. In patented plastic holder.

Part No. Qty Description

K151.2180 1 Set **8 Piece Set**

8 x Sizes: 2, 2.5, 3, 4, 5, 6, 8, 10 mm.





TENG TOOLS Combination Spanners

Polished heads, satin finish. 12 Point. 15° offset ring ends.

Part No.	Qty	Size
T600507	1	7 mm
T600508	1	8 mm
T600510	1	10 mm
T600513	1	13 mm
T600515	1	15 mm
T600517	1	17 mm
T600519	1	19 mm
T600521	1	21 mm
T600522	1	22 mm
T600524	1	24 mm
T600527	1	27 mm
T600530	1	30 mm
T600536	1	36 mm



KS TOOLS 'CHROMEplus' Mirror Polished Combination Spanner Set

Chrome plated, mirror polished. DIN 3338, ISO 3318, ISO 7738. Head offset 15°, jaw offset 15°. Supplied in a heavy duty storage pouch roll.



Part No.	Qty	Description
K518.0643	1 Set	13 Piece Set

13 x Sizes: 6, 7, 8, 9, 10, 11, 12, 13, 14, 15, 17, 19, 22 mm.



TENG TOOLS Combination Spanners Set

Polished heads, satin finish. 12 Point. 15° offset ring ends. Supplied in a plastic holder.

Part No.	Qty	Description
T6510A	1 Set	10 Piece Set

10 x Sizes: 8, 10, 11, 12, 13, 14, 15, 16, 17, 19 mm.



KS TOOLS 'CHROMEplus' Extra Long Double Ring Spanner Set

Chrome plated, mirror polished, straight slim line head. Extra narrow shape spanner head.



- Designed for high torque tightening and loosening.
- Ideal for loosening very tight fittings in awkward areas where the use of a ratchet is not possible: e.g. on axles, ball joints, suspensions, steering components, propeller shaft couplings, etc.
- No need to lengthen normal spanners which can lead to injury.

Part No.	Qty	Description
K518.0800	1 Set	6 Piece Set

6 x Sizes: 10 x 11, 12 x 14, 13 x 15, 16 x 18, 17 x 19, 22 x 24 mm.



TENG TOOLS Combination Spanners Set

Polished heads, satin finish. 12 Point. 15° offset ring ends. Supplied in a tool tray.

Part No.	Qty	Description
TTT1236	1 Set	12 Piece Set

12 x Sizes: 8, 9, 10, 11, 12, 13, 14, 15, 16, 17, 18, 19 mm



BEST SELLER



TENG TOOLS 'Rigger Jigger'

Compact double ring spanner. Length: 120 mm.

Part No.	Qty	Size
T601013	1	10 mm x 13 mm



TENG TOOLS Combination Spanners Set

Polished heads, satin finish. 12 Point. 15° offset ring ends. Supplied in a TTX tool tray.

Part No.	Qty	Description
TTX2032	1 Set	7 Piece Set

7 x Sizes: 20, 21, 22, 24, 27, 30, 32 mm



Gripper Wrench Organizer

For use in toolboxes or on the wall. Folding space saver handle.

Part No.	Qty	Holds Up To
TL8050	1	12 Spanners



**KS TOOLS
Combination Spanner Set**

Chrome vanadium steel, satin finish, polished heads, DIN 3113 Form A/ISO 3318/ISO 7738. Head offset 15°, jaw offset 15°. FlankTraction profile (12 point). Supplied in a plastic holder.

Part No.	Qty	Description
K517.0052	1 Set	12 Piece Set
12 x Sizes: 8, 9, 10, 11, 12, 13, 14, 15, 16, 17, 18, 19 mm		



KS TOOLS 3/8" Drive 6 Point Crow Foot Wrench Set

Chrome plated, matt finish. Supplied on a socket rail.

3/8"

Part No.	Qty	Description
K913.3800	1 Set	10 Piece Set

10 x Sizes: 10, 11, 12, 13, 14, 15, 16, 17, 18, 19 mm.



**LASER
3/8" Drive Flare Nut Crowfoot Spanners**

Supplied on a socket rail.

3/8"

Part No.	Qty	Description
TK6400	1 Set	8 Piece Set

8 x Sizes: 10, 11, 13, 14, 15, 17, 19, 22 mm.



KS TOOLS Combination Spanner Set

Chrome vanadium steel, satin finish, polished heads. DIN 3113 Form A/ISO 3318/ISO 7738. Head offset 15°, jaw offset 15°. FlankTraction profile (12 point). Supplied in a heavy duty storage pouch roll.

Part No.	Qty	Description
K517.0043	1 Set	21 Piece Set

21 x Sizes: 6, 7, 8, 9, 10, 11, 12, 13, 14, 15, 16, 17, 18, 19, 20, 21, 22, 24, 27, 30, 32 mm.



**BAHCO
Adjustable Wrench**

Phosphated finish. 40% wider opening than standard 8" (200 mm) wrench with convenient length handle.

Part No.	Qty	Length	Max Jaw Capacity
TB9031	1	8 1/2"	218mm 38 mm



**BAHCO
Adjustable Wrenches**

Phosphate finish. DIN 3117.

Part No.	Qty	Length	Max Jaw Opening
TB8070	1	155 mm	20 mm
TB8071	1	205 mm	27 mm
TB8072	1	255 mm	30 mm
TB8073	1	305 mm	34 mm
TB8074	1	380 mm	44 mm
TB8075	1	455 mm	53 mm



**TENG TOOLS
Adjustable Wrenches**

Phosphate finish.

Part No.	Qty	Length
T4002	1	6" (150 mm)
T4003	1	8" (200 mm)
T4004	1	10" (250 mm)
T4005	1	12" (300 mm)
T4006	1	15" (375 mm)
T4007	1	18" (450 mm)



KS TOOLS Extra Long Combination Spanner Set

Chrome vanadium steel, polished heads, DIN 3113 Form A/ISO 3318/ISO 7738. Head offset 15°, jaw offset 15°. FlankTraction profile (12 point). Supplied in a display box.

Part No.	Qty	Description
K519.0660	1 Set	11 Piece Set

10 x Sizes: 10, 11, 12, 13, 14, 15, 16, 17, 18, 19 mm





**KS TOOLS 'GEARplus'®
Reversible Ratchet
Combination
Spanner Set**

Chrome plated, mirror polished. DIN 3110, ISO 3318. Head offset 15°, jaw offset 15°. 72 teeth, 5° angle reversible ratchet mechanism. Supplied in a robust plastic storage case.

Part No.	Qty	Description
K503.4646	1 Set	6 Piece Set
6 x Sizes: 8, 10, 12, 13, 17, 19 mm.		



**KS TOOLS 'GEARplus'®
Reversible Ratchet
Combination
Spanner Set
with Adaptors**

Chrome plated, mirror polished. DIN 3110, ISO 3318. Head offset 15°, jaw offset 15°. 72 teeth, 5° angle reversible ratchet mechanism. Supplied in a robust plastic storage case.

- Includes 'GEARplus'® Adaptors: Allows use as reversible ratchet and bit ratchet. Can be used with 1/4", 3/8" and 1/2" sockets and with any 1/4" bit.

Part No.	Qty	Description
K503.4666	1 Set	16 Piece Set
12 x Reversible Spanners: 8, 9, 10, 11, 12, 13, 14, 15, 16, 17, 18, 19 mm. 4 x GEARplus® Adaptors: 1 x for Bits: 1/4". 3 x for Sockets: 1/4", 3/8", 1/2".		



**KS TOOLS 'GEARplus'®
Ratchet Combination
Spanner Set**

Chrome plated, mirror polished. DIN 3110, ISO 3318. Head offset 15°, jaw offset 15°. 72 teeth, 5° angle ratchet mechanism. Supplied in a robust plastic storage case.

Part No.	Qty	Description
K503.4265	1 Set	12 Piece Set
12 x Sizes: 8, 9, 10, 11, 12, 13, 14, 15, 16, 17, 18, 19 mm.		



**TENGOOLS Reversible
Ratcheting Combination Spanners**

Polished heads, satin finish. 12 Point. 15° offset ring ends. Flip reverse switch.

Part No.	Qty	Size
T600508R	1	8 mm
T600510R	1	10 mm
T600513R	1	13 mm
T600515R	1	15 mm
T600517R	1	17 mm
T600519R	1	19 mm
T600522R	1	22 mm
T600524R	1	24 mm



**TENGOOLS
Reversible
Ratcheting
Combination
Spanners Set**

Polished heads, satin finish. 12 Point. 15° offset ring ends. Supplied in a tool tray.

Part No.	Qty	Description
TTT6508R	1 Set	8 Piece Set
8 x Sizes: 8, 10, 11, 12, 13, 14, 17, 19 mm		



**KS TOOLS 'DUO GEARplus'®
Reversible Ratchet Ring/Open-End Combi
Spanners with Open Jaw Ratchet Function**

Based on DIN 3113/ISO 3318. Chrome vanadium fine satin finish. Jaw offset by 15°. 72 teeth ratcheting action.

- Innovative open-end jaw ratchet mechanism
- Flank Traction profile



Part No.	Qty	Size	Length
K503.5908	1	8 mm	140 mm
K503.5909	1	9 mm	150 mm
K503.5910	1	10 mm	159 mm
K503.5911	1	11 mm	166 mm
K503.5912	1	12 mm	172 mm
K503.5913	1	13 mm	178 mm
K503.5914	1	14 mm	191 mm
K503.5915	1	15 mm	200 mm
K503.5916	1	16 mm	208 mm
K503.5917	1	17 mm	225 mm
K503.5918	1	18 mm	236 mm
K503.5919	1	19 mm	248 mm



**KS TOOLS
'DUO GEARplus'®**

Reversible Ratchet Ring/Open-End Combi Spanners with Open Jaw Ratchet Function Set

Part No.	Qty	Description
K503.5905	1 Set	5 Piece Set
5 x Sizes: 8, 10, 13, 17, 19 mm.		



KS TOOLS
'SlimPOWER' Reversible Ratchets

1/4" 3/8" 1/2"

Chrome plated and mirror polished. DIN 3122 / ISO 3315. Square drive adaptor to DIN 3120 / ISO 1174 with ball lock. Ergonomic non-slip 2 component handle. 72 teeth, 5° angle ratchet mechanism. Extremely slim line head. Quick release system.

Part No.	Qty	Drive Size	Weight	Max Torque
K920.1490	1	1/4" Drive	80g	102 Nm
K920.3890	1	3/8" Drive	180g	102 Nm
K920.1290	1	1/2" Drive	356g	710 Nm



KS TOOLS
'CHROMEplus' Reversible Ratchets

1/4" 3/8" 1/2"

Chrome plated, mirror polished. DIN 3122, ISO 3315. 45 teeth, 8° angle ratchet mechanism. Quick release system. Ergonomic non-slip 2 component handle.

Part No.	Qty	Drive Size
K918.1400	1	1/4" Drive
K918.3800	1	3/8" Drive
K918.1200	1	1/2" Drive



LASER Swivel Head Ratchet with T-Handle

Chrome plated, mirror polished. Two innovative actions in one ratchet. Use as a swivel head ratchet or use as a T-handle ratchet.

3/8"

Part No.	Qty	Drive Size
TL3890	1	3/8" Drive



KS TOOLS
'CHROMEplus' Flex Head Ratchet

Chrome plated, mirror polished. DIN 3122, ISO 3315. 72 teeth, 5° angle ratchet mechanism. Quick release system. American style handle

3/8"

Part No.	Qty	Drive Size
K918.3997	1	3/8" Drive



TENG TOOLS
'FRP' Ratchets

Steel reinforced fibre ratchet with fixed drive.

1/4" 3/8" 1/2"

- 45 teeth provides 8° increment.
- Quick release and flip reverse system.
- Lighter and more comfortable than normal ratchets, yet just as strong.

Part No.	Qty	Drive Size
T1400FRP	1	1/4" Drive
T3800FRP	1	3/8" Drive
T1200FRP	1	1/2" Drive



1/4" 3/8" 1/2"

TENG TOOLS
72 Teeth Ratchet

Ultra slim ratchet head with 72 teeth giving a 6° increment between clicks.

- Ideal for use in confined spaces
- Quick release and twist reverse system
- An uncomplicated mechanism provides higher torque capacity and longer service life
- 72 teeth for a smoother operation
- Rubber handle

Part No.	Qty	Drive Size
T1400-72N	1	1/4" Drive
T3800-72N	1	3/8" Drive
T1200-72N	1	1/2" Drive



SIGNET Ratchets

45 Teeth.

1/4" 3/8" 1/2"

Part No.	Qty	Drive Size	Length
TL2620	1	1/4" Drive	140 mm
TL2630	1	3/8" Drive	195 mm
TL2640	1	1/2" Drive	245 mm



SIGNET Professional Reversible Ratchet

Chrome vanadium head. Quick-release mechanism.

3/4"

Part No.	Qty	Drive Size	Length
TL4050	1	3/4" Drive	510 mm



KS TOOLS
'CHROMEplus' Telescopic Reversible Ratchet

Chrome plated, mirror polished. DIN 3122, ISO 3315. 36 teeth, 10° angle ratchet mechanism. Quick release system. Ergonomic non-slip 2 component handle. Extension Range: 380 to 500 mm.

1/2"

Part No.	Qty	Drive Size
K918.1270	1	1/2" Drive





KS TOOLS 'CHROMEplus' Power Bars

Chrome plated, mirror polished.
Extra long handle with pivot head.



Part No.	Qty	Drive Size	Length
K918.3826	1	3/8" Drive	400 mm
K918.3826-1	1	3/8" Spare Head	
K918.1292	1	1/2" Drive	600 mm
K918.1292-1	1	1/2" Spare Head	
K918.1801	1	3/4" Drive	1030 mm
K918.1802	1	1" Drive	1050 mm

SIGNET Power Bars

Part No.	Qty	Drive Size	Length
TL9190	1	3/8" Drive	375 mm (15")
TL9190H	1	3/8" Spare Head	
TL9290	1	1/2" Drive	600 mm (24")
TL9290H	1	1/2" Spare Head	
TL4060	1	3/4" Drive	1,000 mm (39")
TL4060H	1	3/4" Spare Head	



TENG TOOLS 1/2" Drive Flex Handle

Part No.	Qty	Description	Length
T1201	1	Flex Handle	450 mm (17")



1/4"

KS TOOLS 1/4" Drive 'LOKPLUS' Extension Set

Knurled, chrome plated, mirror polished. DIN 3123, ISO 3316.

- The LOKPLUS system holds the socket tight to the extension, minimising the risk of losing the socket on removal from the nut or bolt.
- The slim line locking mechanism allows for no increase of the overall dimensions.

Part No. Qty Description

K919.0143 1 Set 3 Piece Set

3 x Lengths: 100, 150, 250 mm



3/8"

KS TOOLS 3/8" Drive 'LOKPLUS' Extension Set

Knurled, chrome plated, mirror polished. DIN 3123, ISO 3316.

- The LOKPLUS system holds the socket tight to the extension, minimising the risk of losing the socket on removal from the nut or bolt.
- The slim line locking mechanism allows for no increase of the overall dimensions.

Part No. Qty Description

K919.0383 1 Set 3 Piece Set

3 x Lengths: 75, 150, 150 mm.



1/2"

KS TOOLS 1/2" Drive 'LOKPLUS' Extension Set

Knurled, chrome plated, mirror polished. DIN 3123, ISO 3316.

- The LOKPLUS system holds the socket tight to the extension, minimising the risk of losing the socket on removal from the nut or bolt.
- The slim line locking mechanism allows for no increase of the overall dimensions.

Part No. Qty Description

K919.0123 1 Set 3 Piece Set

3 x Lengths: 75, 125, 250 mm



BEST SELLER

LASER Power Drive Extensions

Allows cordless power drivers to drive sockets and socket bits.



Part No. Qty Description

TL472 1 Set 3 Piece Set

3 x Drive Sizes: 1/4", 3/8", 1/2".



TENG TOOLS 1/4" Drive Extensions

Chrome vanadium steel. Satin finish.

1/4"

Part No.	Qty	Length	
TM140020	1	2"	50 mm
TM140021	1	4"	100 mm
TM140022	1	6"	150 mm



TENG TOOLS 3/8" Drive Extensions

Chrome vanadium steel. Satin finish.

3/8"

Part No.	Qty	Length	
TM380020	1	3"	75 mm
TM380021	1	6"	150 mm
TM380022	1	10"	254 mm



TENG TOOLS 1/2" Drive Extensions

Chrome vanadium steel. Satin finish.

1/2"

Part No.	Qty	Length	
TM120020	1	2 1/2"	63.5 mm
TM120021	1	5"	125 mm
TM120022	1	10"	254 mm



TENG TOOLS 1/4", 3/8" & 1/2" Drive Socket Accessories Set

Supplied in a TTX tool tray.

1/4" 3/8" 1/2"

Part No.	Qty	Description
TTXEXT13	1 Set	13 Piece Set

2 x 1/4" Extensions: 6", 12". 1 x 1/4" Universal Joint. 1 x 3/8" Wobble Extension 3". 1 x 3/8" Extension 20".
1 x 3/8" Universal Joint. 1 x 3/8" F-Bar Adaptor: 3/8" F - 1/4" M. 1 x 1/2" Wobble Extension: 3".
1 x 1/2" Extension: 20". 1 x 1/2" Universal Joint. 1 x T-Handle Grip. 2 x Mini Screwdrivers, Hex: 2.0, 2.5 mm.



KS TOOLS 'CHROMEplus®' Universal Joints

Chrome plated, mirror polished. DIN 3123, ISO 3316.

Part No.	Qty	Size
K918.1450	1	1/4" Drive
K918.1250	1	1/2" Drive



TENG TOOLS Universal Joints

Part No.	Qty	Drive	Length
TM140030	1	1/4" Drive	33 mm
TM380030	1	3/8" Drive	50 mm
TM120030	1	1/2" Drive	69 mm



KS TOOLS 'CHROMEplus®' Sliding T-Bar Adaptors

Chrome plated, mirror polished. DIN 3123, ISO 3316.

Part No.	Qty	Size
K918.1449	1	3/8" M : 1/4" F
K918.3807	1	1/2" F : 3/8" M



TENG TOOLS Drive Adaptors

With hole for turning using an extension bar.

Part No.	Qty	Size
TM140036	1	1/4" F : 3/8" M
TM380036	1	3/8" F : 1/2" M
TM120036	1	1/2" F : 3/8" M





TENGOOLS 1/4" Drive Socket Set

Supplied in a plastic storage box with rubber feet to prevent sliding.

1/4

Part No.	Qty	Description
TT1424	1 Set	23 Piece Set

1 x FRP Ratchet. 1 x Hanging Hook. 1 x Universal Joint. 1 x Extension: 3". 1 x Coupler Adaptor. 11 x Regular Sockets, 6 point: 4, 5, 5.5, 6, 7, 8, 9, 10, 11, 12, 13 mm. 8 x Hex Bits 1/4", 25 mm. 2 x Slotted: 4, 5.5 mm 2 x PH: PH1, PH2. 2 x TX: TX15, TX20. 2 x Hex: 5, 6 mm.



TENGOOLS 1/4" Drive Socket Set

Supplied in a plastic storage box with rubber feet to prevent sliding.

1/4

Part No.	Qty	Description
TT1436	1 Set	36 Piece Set

1 x FRP Ratchet. 1 x Universal Joint. 2 x Extensions: 2", 4". 1 x Coupler Adaptor. 1 x T-Bar Adaptor: 3/8" F - 1/4" M. 3 x Hex Keys: 1.5, 2, 2.5 mm. 10 x Regular Sockets, 6 point: 4, 5, 5.5, 6, 7, 8, 10, 11, 12, 13 mm. 6 x Deep Sockets, 6 point: 6, 7, 8, 10, 12, 13 mm. 11 x Hex Bits 1/4", 25 mm: 2 x Slotted: 4, 5.5 mm. 2 x PH: PH1, PH2. 2 x PZ: PZ1, PZ2. 3 x TX: TX10, TX15, TX20. 2 x Hex: 5, 6 mm.



KSTOOLS 'CHROMEplus'[®] 1/4" Drive Socket Set

Chrome plated, mirror polished. Precision manufactured to DIN/ISO standards. Supplied in a robust plastic storage case.

1/4

Part No.	Qty	Description
K918.0646	1 Set	46 Piece Set

13 x Sockets 1/4": 4, 4.5, 5, 5.5, 6, 7, 8, 9, 10, 11, 12, 13, 14 mm. 21 x Bit sockets 1/4": 3 x Slotted: 4, 5.5, 7 mm. 3 x PHILLIPS: PH1, PH2, PH3. 2 x POZIDRIV: PZ1, PZ2. 6 x Hexagonal: 3, 4, 5, 6, 7, 8 mm. 7 x TORX: T10, T15, T20, T25, T27, T30, T40. 3 x Extensions 1/4", knurled, with hexagonal drive: 50, 100, 150 mm. 1 x Spinner handle 1/4" drive. 1 x Universal joint 1/4". 1 x Sliding T-bar 1/4". 4 x Hex key wrenches: 1, 1.5, 2, 2.5 mm. 1 x Socket adaptor 1/4" square with 1/4" hexagonal drive. 1 x Reversible ratchet 1/4".



TENGOOLS 3/8" Drive Socket Set

Supplied in a plastic storage box with rubber feet to prevent sliding.

3/8

Part No.	Qty	Description
TT3834	1 Set	24 Piece Set

1 x FRP Ratchet. 1 x Hanging Hook. 1 x Extension Bar: 3". 1 x Coupler Adaptor. 9 x Regular Sockets, 6 point: 8, 10, 11, 12, 13, 14, 15, 17, 19 mm. 11 x Hex Bits 1/4", 25 mm: 2 x Slotted: 4, 5.5 mm. 2 x PH: PH1, PH2. 2 x PZ: PZ1, PZ2. 3 x TX: TX10, TX15, TX20. 2 x Hex: 5, 6 mm.



TENGOOLS 3/8" Drive Socket Set

Supplied in a plastic storage box with rubber feet to prevent sliding.

3/8

Part No.	Qty	Description
TT3839	1 Set	39 Piece Set

1 x FRP Ratchet. 1 x Universal Joint. 1 x Wobble Extension: 3". 1 x Extension: 6". 1 x Coupler Adaptor. 1 x T-Bar Adaptor: 1/2" F - 3/8" M. 14 x Regular Sockets, 6 point: 8, 9, 10, 11, 12, 13, 14, 15, 16, 17, 18, 19, 21, 22 mm. 6 x Deep Sockets, 6 point: 8, 10, 12, 13, 17, 19 mm. 2 x Spark Plug Sockets: 16, 21 mm. 11 x Hex Bits 1/4", 25 mm: 2 x Slotted: 4, 5.5 mm. 2 x PH: PH1, PH2. 2 x PZ: PZ1, PZ2. 3 x TX: TX10, TX15, TX20. 2 x Hex: 5, 6 mm.



KSTOOLS 'CHROMEplus'[®] 3/8" Drive Regular & Deep Socket Set

Chrome plated, mirror polished. Precision manufactured to DIN/ISO standards. Supplied in a robust plastic storage case.

3/8

Part No.	Qty	Description
K918.0627	1 Set	27 Piece Set

13 x Sockets 3/8": 8, 10, 11, 12, 13, 14, 15, 16, 17, 18, 19, 22, 24 mm. 10 x Deep Sockets 3/8": 10, 11, 12, 13, 14, 15, 16, 17, 18, 19 mm. 2 x Wobble extension 3/8", knurled: 75, 150 mm. 1 x Universal joint 3/8". 1 x Reversible ratchet 3/8".



KS TOOLS 'CHROMEplus' 3/8" Drive Socket & Bit Socket Set

Chrome plated, mirror polished.
Precision manufactured to DIN/ISO standards.
Supplied in a robust plastic storage case.

3/8"

Part No.	Qty	Description
----------	-----	-------------

K918.0661 1 Set 61 Piece Set

18 x Sockets 3/8": 6, 7, 8, 9, 10, 11, 12, 13, 14, 15, 16, 17, 18, 19, 20, 21, 22, 24 mm.
10 x Sockets 3/8", deep: 8, 9, 10, 11, 12, 13, 14, 15, 17, 19 mm. 2 x Spark plug sockets 3/8": 16, 21 mm.
26 x Bit sockets 3/8": 3 x Slotted: 5.5, 7, 8 mm. 3 x PHILLIPS: PH1, PH2, PH3. 3 x POZIDRIV: PZ1, PZ2, PH3.
7 x Hexagonal: 3, 4, 5, 6, 7, 8, 10 mm. 10 x TORX: T10, T15, T20, T25, T27, T30, T40, T45, T50, T55.
1 x Wobble extension 3/8", knurled: 75 mm. 1 x Wobble extension 3/8", knurled: 250 mm.
1 x Sliding T-bar adaptor for extension 3/8", adaptor function. 1 x Universal joint 3/8". 1 x Reversible ratchet 3/8".



KS TOOLS 'CHROMEplus' 1/2" Drive Socket Set

Chrome plated, mirror polished.
Precision manufactured to DIN/ISO standards.
Supplied in a robust plastic storage case.

1/2"

Part No.	Qty	Description
----------	-----	-------------

K918.0635 1 Set 35 Piece Set

18 x Sockets 1/2": 10, 11, 12, 13, 14, 15, 16, 17, 18, 19, 20, 21, 22, 24, 27, 30, 32, 34 mm.
10 x Sockets 1/2", deep: 10, 11, 12, 13, 14, 15, 16, 17, 18, 19 mm. 2 x Spark plug sockets 1/2": 16, 21 mm.
2 x Extension 1/2", knurled: 125, 250 mm. 1 x Universal joint 1/2". 1 x Sliding T-bar adaptor 1/2".
1 x Reversible ratchet 1/2".



TENGOOLS 1/2" Drive Socket Set

Supplied in a plastic storage box with rubber feet to prevent sliding.

1/2"

Part No.	Qty	Description
----------	-----	-------------

TT1221 1 Set 21 Piece Set

1 x FRP Ratchet. 1 x Universal Joint. 2 x Extensions: 2 1/2", 6". 1 x T-Bar Adaptor: 3/8" F - 1/2" M.
16 x Regular Sockets, 12 point: 10, 11, 12, 13, 14, 15, 16, 17, 18, 19, 21, 22, 24, 27, 30, 32 mm.



3/8"

1/2"

KS TOOLS 'TRIPLEplus' 19 mm Drive (3/8" & 1/2") 'Go-Through' Socket Set

Chrome plated, mirror polished. Precision manufactured to DIN/ISO standards.
Supplied in a robust plastic storage case.

- 'TRIPLEplus' Profile, the perfect torque transfer, works on hexagonal, 12 point, E-TORX®, nuts and bolts as well as many imperial sizes.

Part No.	Qty	Description
----------	-----	-------------

K916.4050 1 Set 17 Piece Set

13 x TRIPLEplus 'Go-Through' sockets: 10, 11, 12, 13, 14, 15, 16, 17, 18, 19, 21, 22, 24 mm.
1 x Go-through socket extension with 19 mm drive: 75 mm. 1 x Socket adaptor 19 mm x 3/8".
1 x Socket adaptor 19 mm x 1/2". 1 x Go-through reversible ratchet, with 19 mm drive.





KS TOOLS 3/8" Drive Hex Bit Socket Set

Chrome plated, matt finish. Length: 50 mm. Supplied on a socket rail.

Part No.	Qty	Description
K911.3945	1 Set	7 Piece Set

7 x Sizes: 4, 5, 6, 7, 8, 10, 12 mm.



TENGOOLS 3/8" Drive Hex Bit Socket Set

Supplied on a socket rail.

Part No.	Qty	Description
TM3812	1 Set	9 Piece Set

9 x Sizes: 3, 4, 5, 5.5, 6, 7, 8, 10, 12 mm



TENGOOLS 1/2" Drive Hex Bit Socket Set

Supplied on a socket rail.

Part No.	Qty	Description
TM1212	1 Set	9 Piece Set

9 x Sizes: 5, 6, 7, 8, 9, 10, 12, 14, 17 mm



KS TOOLS 3/8" DriveTORX® Bit Socket Set

Chrome plated, matt finish. Supplied on a socket rail.

Part No.	Qty	Description
K911.3935	1 Set	10 Piece Set

10 x Sizes: T10, T15, T20, T27, T30, T40, T45, T50, T55.



TENGOOLS 1/2" Drive TX Bit Socket Set

Supplied on a socket rail.

Part No.	Qty	Description
TM1213TX	1 Set	9 Piece Set

9 x Sizes: TX20, TX25, TX27, TX30, TX40, TX45, TX50, TX55, TX60



TENGOOLS 1/4" & 3/8" Drive TX-E Bit Socket Set

Supplied on a socket rail.

Part No.	Qty	Description
TM3814	1 Set	10 Piece Set

5 x 1/4" Drive: E4, E5, E6, E7, E8. 5 x 3/8" Drive: E10, E12, E14, E16, E18



TENGOOLS 1/4" Drive Regular Socket Set - 6 Point

Supplied on a socket rail.

Part No.	Qty	Description
TM1412	1 Set	12 Piece Set

12 x Regular Sockets, 6 point: 4, 4.5, 5, 5.5, 6, 7, 8, 9, 10, 11, 12, 13 mm.



TENGOOLS 3/8" Drive Regular Socket Set - 6 Point

Supplied on a socket rail.

Part No.	Qty	Description
TM3816	1 Set	16 Piece Set

16 x Regular Sockets, 6 point: 7, 8, 9, 10, 11, 12, 13, 14, 15, 16, 17, 18, 19, 20, 21, 22 mm



TENGOOLS 1/2" Drive Regular Socket Set - 12 Point

Supplied on a socket rail.

Part No.	Qty	Description
TM1215MM	1 Set	15 Piece Set

15 x Sizes: 10, 12, 13, 14, 15, 16, 17, 18, 19, 21, 22, 24, 27, 30, 32 mm





KS TOOLS 'CHROMEplus'® 1/4" Drive Deep Socket Set

Chrome plated, mirror polished. DIN 3124, ISO 2725. Supplied on a socket rail. 1/4"

Part No.	Qty	Description
K918.0610	1 Set	10 Piece Set

10 x Sizes: 4, 5, 6, 7, 8, 9, 10, 11, 12, 13 mm.



TENGOOLS 1/4" Drive Deep Socket Set - 6 Point

Supplied on a socket rail. 1/4"

Part No.	Qty	Description
TM1407	1 Set	9 Piece Set

9 x Deep Sockets 6-pt: 4, 5, 6, 7, 8, 9, 10, 12, 13 mm



KS TOOLS 'CHROMEplus'® 3/8" Drive Deep Socket Set

Chrome plated, mirror polished. DIN 3124, ISO 2725. Supplied on a socket rail. 3/8"

Part No.	Qty	Description
K918.0611	1 Set	11 Piece Set

11 x Sizes: 8, 10, 11, 12, 13, 14, 15, 16, 17, 18, 19 mm.



TENGOOLS 3/8" Drive Deep Socket Set - 6 Point

Supplied on a socket rail. 3/8"

Part No.	Qty	Description
TM3807	1 Set	7 Piece Set

7 x Deep Sockets 6-pt: 10, 12, 13, 14, 15, 17, 19 mm



TENGOOLS 3/8" Drive Spark Plug Sockets - 6 Point

Part No.	Qty	Size
TM380040	1	16 mm
TM380046	1	21 mm

3/8"

KS TOOLS 'CHROMEplus'® 1/2" Drive Deep Socket Set

Chrome plated, mirror polished. DIN 3124, ISO 2725. Supplied on a socket rail. 1/2"

Part No.	Qty	Description
K918.0612	1 Set	10 Piece Set

10 x Sizes: 10, 11, 12, 13, 14, 15, 16, 17, 18, 19 mm.



TENGOOLS 1/2" Drive Deep Socket Set - 6 Point

Supplied on a socket rail. 1/2"

Part No.	Qty	Description
TM1208-6	1 Set	8 Piece Set

8 x Sizes: 13, 14, 15, 16, 17, 18, 19, 24 mm



Temperature Sender Socket Set

Chrome plated. Allows access to difficult pipe connectors and wired sensor units (NOT Lambda). Ideal for the loosening of ABS pipes, master cylinder pipes, diesel injection pipes & wired sensors (coolant sensors, etc).

- A great time saving tool when access is difficult.

Part No.	Qty	Description
TL3860	1 Set	6 Piece Set

6 x Sizes: 10, 11, 12, 14, 17, 19 mm.



Socket Rails

Supplied complete with 16 spring steel socket clips. (Sockets NOT included).

Part No.	Qty	Drive	Length
TL8012	1 Set	1/2"	410 mm
TL8014	1 Set	1/4"	410 mm
TL8038	1 Set	3/8"	410 mm

1/4" 3/8" 1/2"





KS TOOLS 'CHROMEplus®'
1/4" Drive Deep Sockets

1/4"

Chrome plated, mirror polished. DIN 3124, ISO 2725.

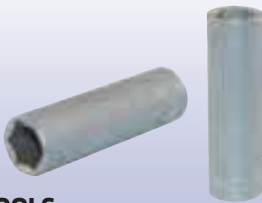
Part No.	Qty	Size
K918.1424	1	4 mm
K918.1425	1	5 mm
K918.14255	1	5.5 mm
K918.1426	1	6 mm
K918.1427	1	7 mm
K918.1428	1	8 mm
K918.1429	1	9 mm
K918.1430	1	10 mm
K918.1431	1	11 mm
K918.1432	1	12 mm
K918.1433	1	13 mm



TENG TOOLS
1/4" Drive Deep Sockets - 6 Point

1/4"

Part No.	Qty	Size
TM140604	1	4 mm
TM140605	1	5 mm
TM1406055	1	5.5 mm
TM140606	1	6 mm
TM140607	1	7 mm
TM140608	1	8 mm
TM140609	1	9 mm
TM140610	1	10 mm
TM140611	1	11 mm
TM140612	1	12 mm
TM140613	1	13 mm



KS TOOLS 'CHROMEplus®'
3/8" Drive Deep Sockets

3/8"

Chrome plated, mirror polished. DIN 3124, ISO 2725.

Part No.	Qty	Size
K918.3828	1	8 mm
K918.3829	1	9 mm
K918.3830	1	10 mm
K918.3831	1	11 mm
K918.3832	1	12 mm
K918.3833	1	13 mm
K918.3834	1	14 mm
K918.3835	1	15 mm
K918.3836	1	16 mm
K918.3837	1	17 mm
K918.3838	1	18 mm
K918.3839	1	19 mm



TENG TOOLS
3/8" Drive Deep Sockets - 6 Point

3/8"

Part No.	Qty	Size
TM380607	1	7 mm
TM380608	1	8 mm
TM380609	1	9 mm
TM380610	1	10 mm
TM380611	1	11 mm
TM380612	1	12 mm
TM380613	1	13 mm
TM380614	1	14 mm
TM380615	1	15 mm
TM380616	1	16 mm
TM380617	1	17 mm
TM380618	1	18 mm
TM380619	1	19 mm
TM380620	1	20 mm
TM380621	1	21 mm
TM380622	1	22 mm



KS TOOLS 'CHROMEplus®'
1/2" Drive Deep Sockets

1/2"

Chrome plated, mirror polished. DIN 3124, ISO 2725.

Part No.	Qty	Size
K918.1240	1	10 mm
K918.1241	1	11 mm
K918.1242	1	12 mm
K918.1243	1	13 mm
K918.1244	1	14 mm
K918.1245	1	15 mm
K918.1246	1	16 mm
K918.1247	1	17 mm
K918.1248	1	18 mm
K918.1249	1	19 mm
K918.1260	1	20 mm
K918.1258	1	21 mm
K918.1252	1	22 mm
K918.1254	1	24 mm
K918.1257	1	27 mm



TENG TOOLS
1/2" Drive Deep Sockets - 12 Point

1/2"

Part No.	Qty	Size
TM120610	1	10 mm
TM120611	1	11 mm
TM120612	1	12 mm
TM120613	1	13 mm
TM120614	1	14 mm
TM120615	1	15 mm
TM120616	1	16 mm
TM120617	1	17 mm
TM120618	1	18 mm
TM120619	1	19 mm
TM120620	1	20 mm
TM120621	1	21 mm
TM120622	1	22 mm
TM120624	1	24 mm
TM120627	1	27 mm
TM120630	1	30 mm
TM120632	1	32 mm
TM120636	1	36 mm





TENGOOLS 1/2" Drive Deep Impact Sockets

1/2"

Part No.	Qty	Size
T920610	1	10 mm
T920611	1	11 mm
T920612	1	12 mm
T920613	1	13 mm
T920614	1	14 mm
T920615	1	15 mm
T920616	1	16 mm
T920617	1	17 mm
T920618	1	18 mm
T920619	1	19 mm
T920621	1	21 mm
T920622	1	22 mm
T920624	1	24 mm
T920627	1	27 mm
T920628	1	28 mm
T920629	1	29 mm
T920630	1	30 mm
T920632	1	32 mm
T920635	1	35 mm
T920636	1	36 mm



KS TOOLS 1" Drive 'Slim Line' Impact Sockets

Special steel, hardened.
Slim line/medium version. Length: 76 mm.

1"

Part No.	Qty	Size
K515.2124	1	24 mm
K515.2127	1	27 mm
K515.2130	1	30 mm
K515.2133	1	33 mm



TENGOOLS 3/4" Drive Deep Impact Sockets

3/4"

Part No.	Qty	Size
T940622	1	22 mm
T940624	1	24 mm
T940627	1	27 mm
T940630	1	30 mm
T940632	1	32 mm
T940633	1	33 mm
T940636	1	36 mm



TENGOOLS 1" Drive Deep Impact Sockets

1"

Part No.	Qty	Size
T910630R	1	30 mm
T910632R	1	32 mm
T910633R	1	33 mm



TENGOOLS Impact Drive Reducers - Ball Bearing Type

Regular 6 point.

Part No.	Qty	Size
T980035	1	3/8" F : 1/4" M

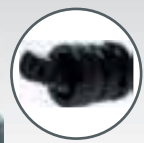

TENGOOLS 1/2" Drive Impact Universal Joint - Hole/Pin Type

1/2"

Part No.	Qty	Description
T920030	1	Universal Joint



TENGOOLS 1/2" Drive Impact Extensions - Hole/Pin Type

1/2"

Part No.	Qty	Length
T920020	1	3"
T920021	1	5"
T920023	1	10"



TENGOOLS Impact Drive Adaptors - Hole/Pin Type

Regular 6 point.

Part No.	Qty	Size
T980036	1	3/8" F : 1/2" M
T920037	1	1/2" F : 3/4" M
T940085	1	3/4" F : 1" M



TENGOOLS Impact Drive Reducers - Hole/Pin Type

Regular 6 point.

Part No.	Qty	Size
T920036	1	1/2" F : 3/8" M
T940037	1	3/4" F : 1/2" M
T910086	1	1" F : 3/4" M





KS TOOLS 1/2" Drive TORX® E-Profile Impact Socket Set

Chrome molybdenum steel, phosphate finish. Supplied in a robust plastic storage case.

Part No. Qty Description

K515.1050 1 Set 9 Piece Set

9 x Sizes: E10, E11, E12, E14, E16, E18, E20, E22, E24.



KS TOOLS 1/2" Drive Impact Driver Set

5/16" Drive impact bits. Includes 1/2" drive impact bit 5/16" hex adaptor and retaining ring. Supplied in a robust plastic storage case.

- Suitable for loosening tight screws
- The use of hammer on the screwdriver prevents the bit slipping from the screw head
- The blow of the hammer also results in a 1/4 right or left turn of the screw (Parable Mechanism)



Part No. Qty Description

K515.1003 1 Set 11 Piece Set

1 x Hand Impact Driver, 1/2". 1 x Impact Bit Adaptor with retaining ring: 1/2" x 5/16". 9 x Impact Bits 5/16", 36 mm: 6 x Slotted: 5, 6, 8, 10, 12, 14 mm. 3 x PHILLIPS: PH1, PH2, PH3.



KS TOOLS 1/2" Drive TORX® Impact Bit Socket Set

Chrome molybdenum steel, phosphate finish. Supplied in a robust plastic storage case.

Part No. Qty Description

K911.0901 1 Set 8 Piece Set

8 x Sizes: T30, T40, T45, T50, T55, T60, T70, T80.



LASER 3/8" Drive Impact Driver Set

Can also be used as 1/2" Drive Handle. Supplied in a metal case.

Part No. Qty Description

TL480 1 Set 7 Piece Set

1 x Hand Impact Driver, 3/8". 1 x Impact Bit Adaptor: 3/8" x 5/16". Impact Bits 5/16", 8 mm: 2 x Slotted: 8, 10 mm. 3 x PH: PH2, PH3, PH4.



TENGOOLS 1/2" Drive Deep Impact Socket Set

Supplied on a socket rail.

Part No. Qty Description

T9126 1 Set 10 Piece Set

10 x Sizes: 10, 11, 12, 13, 14, 17, 19, 21, 22, 24 mm.



TENGOOLS 1/2" Drive Impact Driver Set

Heavy duty with reversible action. Supplied in a plastic storage case.

Part No. Qty Description

TID515 1 Set 15 Piece Set

1 x Hand Impact Driver, 1/2" with reversible action. 1 x Impact Bit Adaptor: 1/2" x 5/16". 1 x Drive Adaptor 5/16" Hex: 3/8" Drive. 12 x Impact Bits 5/16", 36 mm: 4 x Slotted: 6, 8, 10, 12 mm. 4 x PH: PH1, PH2, PH3, PH4. 4 x Hex: 4, 5, 6, 8 mm.



TENGOOLS 1/2" Drive Regular Impact Socket Set

Supplied on a socket rail.

Part No. Qty Description

T9121 1 Set 10 Piece Set

10 x Sizes: 10, 11, 12, 13, 14, 17, 19, 21, 22, 24 mm.



TENGOOLS 5/16" Dr. Impact Driver Bits Set

Suitable for use with Part No. TID515.

Part No. Qty Description

TID515BIT 1 Set 13 Piece Set

1 x Drive Adaptor 5/16" Hex: 3/8" Drive. 12 x Impact Bits 5/16", 36 mm. 4 x Slotted: 6, 8, 10, 12 mm. 4 x PH: PH1, PH2, PH3, PH4. 4 x Hex: 4, 5, 6, 8 mm.



468



469



470



471

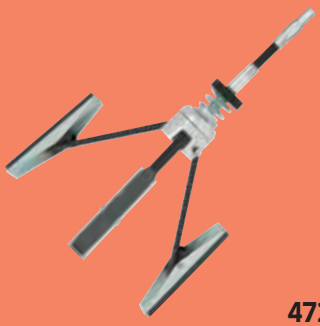

472



473



Specialist Tools



474



475



476

- 468 Torque Wrenches
- 470 Wheel Tools
- 473 Brake Tools
- 476 Stud Removal Tools
- 477 Hooks, Picks + Trim Clip Tools
- 478 Oil Filter Removal Tools
- 479 Windscreen Tools
- 481 Inspection Tools
- 481 Pickup Tools
- 482 Testing Tools



477



478



479



479



480



481



481

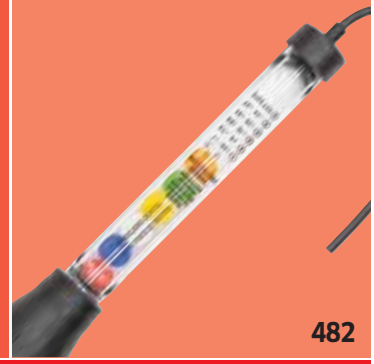

482





KS TOOLS
'ERGOTORQUE' Precision Torque Wrenches

1/4" 3/8" 1/2"

Square drive 'Ball Lock' mushroom key included.
Supplied with calibration certificate guaranteeing accuracy to ±3% according to DIN EN ISO 6789.

Part No.	Qty	Nm	lbf-ft	Scale	Length	Head Ø	Head H.	Weight	Drive Hole	Key Drive
K516.1412	1	5 - 25	0.8 - 18	0.10	289 mm	35 mm	18 mm	460g	3/8"	1/4"
K516.1422	1	10 - 50	4 - 37	0.25	350 mm	45 mm	23 mm	610g	1/2"	3/8"
K516.1432	1	20 - 100	8 - 75	0.50	412 mm	45 mm	23 mm	910g	1/2"	1/2"
K516.1442	1	40 - 200	15 - 150	1.00	500 mm	45 mm	23 mm	1300g	1/2"	1/2"
K516.1482	1	80 - 420	60 - 310	1.00	678 mm	45 mm	23 mm	2100g	1/2"	1/2"

KS TOOLS
Torque Wrench Mushroom Keys

Drive size adaptors

• Polished ratchet head has a very robust mechanism with left and right function which can be changed easily by reversing the mushroom key head drive.

Part No.	Qty	Drive Size	Suits Part No.'s	Colour
K516.1403	1	3/8" x 1/4"	K516.1412	Black
K516.1413	1	3/8"	K516.1412	Black
K516.1423	1	1/2" x 3/8"	K516.1432, K516.1442, K516.1482 & K516.1942	Black



KS TOOLS
Torque Wrench T-Grip Keys

Designed to allow the fast pre-tightening of bolts to within torque range, saving valuable time.

Part No.	Qty	Drive Size	Suits Part No.
K516.1404	1	3/8" x 1/4"	K516.1412
K516.1414	1	3/8"	K516.1412
K516.1424	1	1/2" x 3/8"	K516.1432, K516.1442, K516.1482 & K516.1942
K516.1444	1	1/2"	K516.1432, K516.1442, K516.1482 & K516.1942



KS TOOLS
Torque Wrench 'Ball Lock' Mushroom Key

Drive size adaptor to DIN 3120/ISO 1174.

• Ball lock with push-button quick release function

Part No.	Qty	Drive Size	Suits Part No.'s	Colour
K516.1448	1	1/2"	K516.1432, K516.1442, K516.1482 & K516.1942	Red



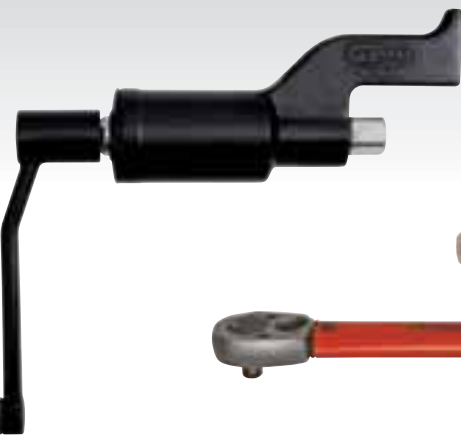
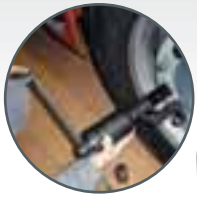

KS TOOLS 'TRUCKplus' 1" Drive Impact Torque Multiplier, Ratio 1:64

Robust tool for loosening and tightening of fast bolts. Planet gearing ensures an increase torque ratio of 1:64.

- The compact and easy to store torque multiplier is essential for all HGV's, agricultural machinery and building equipment.
- Input Torque: 62.5 Nm Max.
- Output Torque: 4000 Nm Max.
- Weight: 8.5 Kg.



Part No.	Qty	Description
----------	-----	-------------

K516.1150 1 Set 5 Piece Set

1 x Impact torque convertor, 1": 3 Pieces.
2 x Impact Sockets, 1" Dr.: 30, 32 mm.

1"



TENG TOOLS Drive Torque Wrenches

DIN 3122.

- For both tightening and final checking of torque.
- Angular gauge for after tightening.
- Graduated in Nm and lbs/ft.
- Lockable setting.
- Degree scale for after tightening of cylinder heads.
- Accuracy ±4%.
- Reversible with lever (right hand action for torque checking only).
- Satin finish with rubber handle.
- Comes with factory calibration certificate.

3/8" 1/2"

Part No.	Qty	Range	Length	Drive
T3892AG-E1	1	5 - 25 Nm (4 - 18 ft.lb)	277 mm	3/8"
T3892AG-E3	1	20 - 110 Nm (15 - 75 ft.lb)	368 mm	3/8"
T1292AG-EP	1	40 - 200 Nm (30 - 150 ft.lb)	465 mm	1/2"
T1292AG-E4	1	70 - 350 Nm (50 - 250 ft.lb)	632 mm	1/2"



KS TOOLS Mechanics Anti-Vibration Gel Gloves

Absorbs and dissipates repeated impacts and shocks.

- Designed for handling power tools, industrial tools and any tools with repetitive vibration.

Part No.	Qty	Size
----------	-----	------

K310.0250 1 Pair L

K310.0255 1 Pair XL

K310.0260 1 Pair XXL



KS TOOLS Mechanics Grip Gloves

Designed for maximum comfort when used in cold, wet and dirty environments.

- Palm covered with rubber nodules for maximum grip.
- Hard wearing 'Dry Suit' material technology for maximum protection.

Part No.	Pack of	Size
----------	---------	------

K310.0350 1 Pair L

K310.0355 1 Pair XL

K310.0360 1 Pair XXL



KS TOOLS 1/2" Drive Alloy Wheel Impact Socket Set

Chrome molybdenum steel, colour plated polished finish. Supplied in a robust plastic storage case.

- Plastic sleeve for protection when working with alloy rims.
- Colour coding allows a quick selection of socket sizes.
- The plastic sleeve can be removed if necessary.

Part No.	Qty	Description
----------	-----	-------------

K515.1005 1 Set 3 Piece Set

3 x Sizes: 17 mm (Blue), 19 mm (Yellow), 21 mm (Red).

1/2"



KS TOOLS 1/2" Drive Alloy Wheel Torque Impact Socket Set

Chrome molybdenum steel, phosphate finish.

Supplied in a robust plastic storage case.

- Plastic sleeve for protection when working with alloy rims
- Colour coding allows a quick selection of socket sizes
- Also suitable for dome nuts with chrome finish

Part No.	Qty	Description
----------	-----	-------------

K515.1070 1 Set 3 Piece Set

3 x Sizes: 17 mm (Blue), 19 mm (Lime), 21 mm (Red).

1/2"





Tyre Bath

- For identifying the location of punctures or bead leaks in car tyres or inner tubes
- * Please allow 5-7 days delivery on this product.

Part No.	Qty	Description
TY1101*	1	Tyre Bath



Static Safety Cage - 4x4/Light Van

Mesh type. Fabricated from RHS steel structure the Static Safety Cage provides protection for the operator whilst inflating larger tyres in the event of the tyre exploding due to over inflation.

- A necessity in the workshop to comply with Health & Safety Executive legislation

* Please allow 5-7 days delivery on this product.

Part No.	Qty	Description	Dimensions
TY1100*	1	Static Safety Cage	36" x 36" x 24"



Wheel Chock - Commercial

Dimensions (L x H x W): 210 x 230 x 160 mm.

Part No.	Qty	Description
TY174	1	Wheel Chock



COMPAC Hydraulic Trolley Jack

- Low entry height
- Lift and turn lowering system prevents unintentional lowering
- Additional foot pedal pumping feature provides fast saddle raising to the load
- Pressure relief valve prevents overloading
- Safety lowering control valve for safe lowering even under load
- * Please allow 5-7 days delivery on this product.

Part No.	Qty	Lifting Capacity	Lifting Height	Chassis Length
TY1020*	1	2 Tonnes	500 mm	720 mm



COMPAC Axle Stands - Low Entry Screw Type

Weight: 11.8 kg each. Fully welded structure in high quality steel. Solid pillars. Solid spindles.

- Fitted with base plates to ensure even distribution of the load
- Designed specifically for Low-Entry applications

Part No.	Qty	Capacity (Per Pair)	Max Height	Min Height
TY1011	Set of 2	24 Tonnes	500 mm	340 mm



OMEGA Axle Stands - Low Entry

Dimensions: (L x W x H): 208 x 108 x 284 mm.

- Fitted with base plates to ensure even distribution of the load

Part No.	Qty	Capacity (Per Pair)	Max Height	Min Height
TY1014	Set of 2	2.8 Tonnes	450 mm	305 mm

SELSON Air Jack Bellows - 2 Bag Type

Complete with extensions.
Working pressure: 100 psi.

- Fast and friendly
- Designed for stability
- Overload safety valve
- Only one airline required



Part No.	Qty	Lifting Capacity	Lifting Height	Min Height
TY1000	1	2.5 Tonnes	340 mm	130 mm

OMEGA LIFT

OMEGA Extra Low Bottle Jack - Hydraulic

Weight: 9.4 kg.



Part No.	Qty	Capacity	Max Height	Min Height
TY1005	1	20 Tonnes	285 mm	165 mm

OMEGA LIFT

OMEGA Bottle Jack - Air/Hydraulic

Weight: 39 lbs.



Part No.	Qty	Capacity	Max Height	Min Height
TY1002	1	20 Tonnes	18 1/4"	9 1/2"

OMEGA LIFT

OMEGA Bottle Jack - Hydraulic

Weight: 12.5 kg. Fabricated from hard-cast steel with heat-treated critical stress areas.

- Hydraulic system is protected from internal damage by a patented by-pass mechanism
- Machined and polished cylinders with die-cut threads provide non-abrasive leak-free, durable performance



Part No.	Qty	Capacity	Max Height	Min Height
TY1006	1	20 Tonnes	475 mm	242 mm



WINNTEC Low Bottle Jack - Air/Hydraulic

Weight: 10 kg.

Part No.	Qty	Capacity	Max Height	Min Height
TY1003	1	20 Tonnes	261 mm	146 mm

MEGA



MEGA Bottle Jack - Air/Hydraulic

Supplied with hose and trigger.
Operating pressure: 7 bar/100 psi.
Weight: 15.5 kg.

- Can also be operated manually as an alternative to the normal air/hydraulic using the pump and supplied pump handle
- Heavy duty saddle
- Integrated carrying handle

Part No.	Qty	Lifting Capacity	Max Height	Min Height
TY1001	1	20 Ton	447 mm	234 mm

MEGA



MEGA Bottle Jack - Hydraulic

Weight: 14.5 kg. High quality lifting jacks manufactured to meet rigid safety and quality standards. Supplied with pump handle.

- Heavy duty saddle
- Integrated carrying handle

Part No.	Qty	Capacity	Max Height	Min Height
TY1004	1	30 Ton	467 mm	242 mm



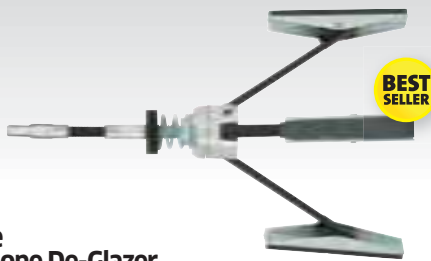

BEST SELLER

HORIZON Adjustable Cylinder Hone De-Glazer

2" - 7" (51 - 178 mm) capacity with three 4" medium stones. Operated by any standard power tool.

Part No.	Qty	Description
TNH325	1 Set	Cylinder Hone De-Glazer



HORIZON Hone Stone Replacements

Part No.	Qty	Length	Grit	Suits Part No.
TNH324	Set of 3	3"	220 Grit (Medium)	TNH325
TNH326-1	Set of 3	4"	400 Grit (Fine)	TNH325
TNH326	Set of 3	4"	220 Grit (Medium)	TNH325
TNH326-3	Set of 3	4"	100 Grit (Coarse)	TNH325



HORIZON Brake Cylinder Hone Set

Adjustable with 3 x 1 1/8" stones. For cylinders 3/4" - 2 1/2" (19 - 64 mm)

Part No.	Qty	Description
TNH310	1 Set	Brake Cylinder Hone Set



HORIZON Hone Stone Replacements

Part No.	Qty	Length	Grit	Suits Part No.s
TNH311	Set of 3	1 1/8"	220 Grit (Medium)	TNH310, TNH330



HORIZON Brake Cylinder Hone Set for Small Cars

Adjustable with 2 x 1 1/8" stones. For most brake cylinders 1/2" - 2 1/2" (13 - 64 mm).

Part No.	Qty	Description
TNH315	1 Set	Brake Cylinder Hone Set



HORIZON Hone Stone Replacements

Part No.	Qty	Length	Grit	Suits Part No.s
TNH316	Set of 2	1 1/8"	220 Grit (Medium)	TNH315, TNH330



HORIZON Disc Brake/Small Engine Cylinder Hone Set

Adjustable with 3 x 2" stones. For cylinders 1 1/4" - 3 1/2" (32 - 89 mm).

Part No.	Qty	Description
TNH320	1 Set	Disc Brake Cylinder Hone Set



HORIZON Hone Stone Replacements

Part No.	Qty	Length	Grit	Suits Part No.s
TNH321	Set of 3	2"	220 Grit (Medium)	TNH320, TNH330



HORIZON Four-In-One Hones Kit

Part No.	Qty	Description
TNH330	1 Kit	14 Piece Kit

Brake Cylinder Hone for small cars: (5/8" - 2 1/4", 16 - 57 mm). Small collar. 2-leg assembly. 2 x 118" stones. Brake Cylinder Hone: (3/4" - 2 1/2", 19 - 64 mm). Medium collar. Medium 3-leg assembly. 3 x 118" stones. Disc Brake Cylinder Hone: (1 1/4" - 3 1/2", 32 - 89 mm). Large collar. Large 3-leg assembly. 3 x 3/4" stones. Small Engine Cylinder Hone: (1 1/4" - 3 1/2", 32 - 89 mm). Large collar. Large 3-leg assembly. 3 x 2" stones



HORIZON Hone Stone Replacements

Part No.	Qty	Length	Grit	Suits Part No.s
TNH316	Set of 2	1 1/8"	220 Grit (Medium)	TNH315, TNH330
TNH311	Set of 3	1 1/8"	220 Grit (Medium)	TNH310, TNH330
TNH321	Set of 3	2"	220 Grit (Medium)	TNH320, TNH330



TENG TOOLS 2-In1 Puller Set

Three-legged combination puller with an extra yoke for switching to two legged pulling. Supplied in a tool tray.

- Reversible legs for internal and external grip.

Part No.	Qty	Description
TTT804	1 Set	6 Piece Set

Combination twin/triple 6" leg puller with 4" capacity.



KS TOOLS Mechanical 2 and 3 Leg Puller

Convertible 2 and 3 leg puller sizes 4" to 85 mm. The puller legs can be used internally or externally.

Part No.	Qty	Size
K700.1120	1 Set	4" to 85 mm

3 Forged puller legs with precisely ground pulling lugs. Forged yoke for 2 or 3 legs. Thrust bolt, fine thread 3/8" x 24 turns, Ø 13 mm, length 120 mm.



KS TOOLS Mechanical 2 and 3 Leg Puller

Convertible 2 and 3 leg puller sizes 6" to 145 mm. The puller legs can be used internally or externally.

Part No.	Qty	Size
K700.1130	1 Set	6" to 145 mm

3 Forged puller legs with precisely ground pulling lugs. Forged yoke for 2 or 3 legs. Thrust bolt, fine thread 3/8" x 1.25, Ø 16 mm, length 175 mm.



One Man Pressure Bleeder Kit

Ideal for brake fluids works from air pressure via the car tyre valve.

Part No.	Qty	Capacity
TL7225	1 Kit	400ml

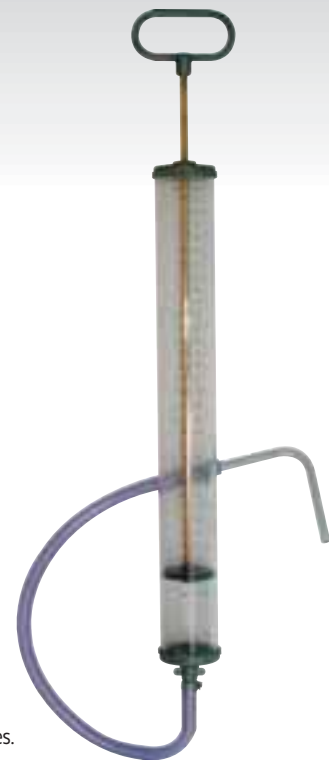

LASER Evacuation/ Dispensing Pump

Removes fluid from overfilled cooling systems or expansion bottles.

- Metric and imperial measures.
- Polycarbonate tube with aluminium cap and handle.

Part No.	Qty	Capacity
TL7400	1	1 Litre

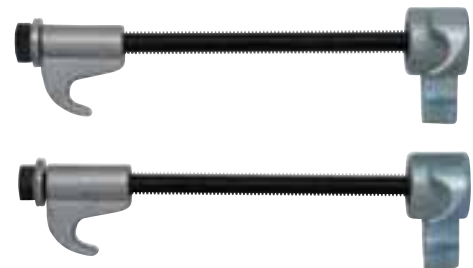

HORIZON Macpherson Strut Coil Spring Compressor

Use to compress the coil spring to replace shock absorber, spring sets, repair bent strut or strut tube and repair damaged spindle. Includes safety hooks and instructions.

Part No.	Qty	Description
TNH900	1 Set	Spring Compressor



Coil Spring Compressor

Part No.	Qty	Description
TL9000	1 Set	Spring Compressor



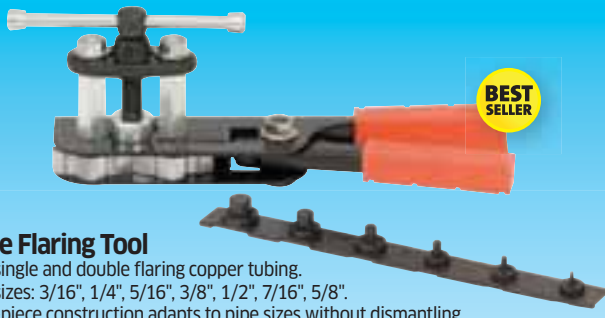

BEST SELLER

Pipe Flaring Tool

For single and double flaring copper tubing.
For sizes: 3/16", 1/4", 5/16", 3/8", 1/2", 7/16", 5/8".
One-piece construction adapts to pipe sizes without dismantling.

- Metal Flare.
- Female Flare.
- Double Flare.

Part No.	Qty	Description
TL961	1	Flaring Tool
TL961R	1	Replacement Form Bar



KS TOOLS Universal Brake Pipe Flaring Tool Kit

Suitable for universal use in automotive and repair shops, i.e. brake and hydraulics. For production to DIN and SAE flaring.

For steel, aluminium and bronze pipes with diameter: 4.75 mm, 3/16", 1/4", 5/16", 3/8".

- Easy to use chuck, cam lever and mandrel revolving head.
- Automatic mandrel return.
- Leaves no damage on the coated pipe.
- Fast and practical work due to the straight flaring motion, (not rotating), this movement prevents the pipe form splitting.

Part No.	Qty	Description
K122.1230	1	Pipe Flaring Tool Kit

1 x Basic unit. 4 x Flaring inserts: Flaring inserts 4.75 mm (3/16"). Flaring inserts 6.350 mm (1/4"). Flaring inserts 7.934 mm (5/16"). Flaring inserts 9.525 mm (3/8").
Tip: To achieve optimal results it is recommended to use a pipe cutter and brake pipe bending tool.

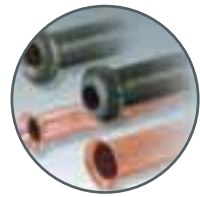

KS TOOLS Universal Master Flaring Tool Set

Supplied in a heavy duty plastic storage case.

- Complete range including shearing tool/bender and tube cutter for professional flaring.

Part No.	Qty	Description
K122.1290	1 Set	15 Piece Set

- 3 x Clamping jaws sets: 4.75, 5.00, 6.00 mm.
- 3 x Flange pins SAE: 4.75 + 5.00 mm - OP1, 6.00 mm - OP1, 4.75 + 5.00 mm + 6.00 - OP2.
- 2 x Flange pins DIN: 4.75 + 5.00 mm, 6.00 mm.
- 1 x Locking screw: M12 x 1.25. 1 x Base body.
- 1 x Hydraulic spindle with toggle: 2 pieces.
- 1 x Grab handle. 1 x 3-in-1 mini bender.
- 1 x Internal deburrer
- 1 x Mini pipe cutter.



KS TOOLS 3-in-1 Mini Pipe Bender

For pipes Ø: 1/8" (3 mm), 3/16" (4.75 mm), 1/4" (6 mm). Suitable for bronze, brass, aluminium and soft steel pipe. For 3 dimensions without change to the bend segment, bend radius and bend form. Bends to a 90° angle. Length: 140 mm.

Part No.	Qty	Description
K120.1050	1	Mini Pipe Bender

Metric Double Flaring Tool Set

Automotive 45°. Supplied in a robust plastic storage case.

- For double flaring soft steel tubing, and single flaring soft copper, aluminium and brass tubing.

Part No.	Qty	Description
TNH826	1 Set	Double Flaring Tool Set

1 x Compressor yoke. 5 x Double flare adaptors: 4.75, 5, 6, 8, 10 mm. 1 x Die holding bar.



Tubing Bending Pliers

For 3/16", 1/4", 5/16" and 3/8" dia copper and steel tubing.

Part No.	Qty	Description
TNH765	1	Tubing Bending Pliers





Brake Pipe Flaring Tool Sets

Flaring tool, punches and die blocks. Supplied in a heavy duty plastic storage case.

Part No.	Qty	Set For
TL965	1 Set	5 Metric & Imperial Sizes
3/16", 1/4", 5/16", 3/8" (SAE 45°), 4.75 mm (DIN).		

Part No.	Qty	Set For
TL965M	1 Set	5 Metric Sizes
4.75 mm, 6 mm, 8 mm, 10 mm, 12 mm (SAE 45°)		

Part No.	Qty	Set For
TL962	1 Set	2 Metric & Imperial Sizes
3/16" (SAE 45°), 4.75 mm (DIN).		

Part No.	Qty	Set For
TL962F	1 Set	2 Imperial Sizes
3/16", 1/4" (SAE 45°)		

Part No.	Qty	Set For
TL976	1 Pair	3/16"
TL977	1 Pair	1/4"
TL978	1 Pair	5/16"
TL979	1 Pair	3/8"
TL980	1 Pair	1/2"
TL981	1 Pair	4.75 mm
TL986	1 Pair	4.75 mm
TL982	1 Pair	6 mm
TL983	1 Pair	8 mm
TL984	1 Pair	10 mm
TL985	1 Pair	12 mm



Die Blocks

Part No.	Qty	Size	Type
TL976	1 Pair	3/16"	SAE 45°
TL977	1 Pair	1/4"	SAE 45°
TL978	1 Pair	5/16"	SAE 45°
TL979	1 Pair	3/8"	SAE 45°
TL980	1 Pair	1/2"	SAE 45°
TL981	1 Pair	4.75 mm	DIN
TL986	1 Pair	4.75 mm	SAE 45°
TL982	1 Pair	6 mm	SAE 45°
TL983	1 Pair	8 mm	SAE 45°
TL984	1 Pair	10 mm	SAE 45°
TL985	1 Pair	12 mm	SAE 45°

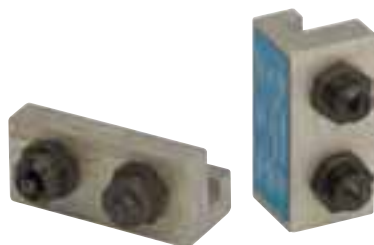

Punches

Part No.	Qty	Sizes	Type
TL971	1	3/16"	4.75 mm SAE 45°
TL972	1	1/4"	6 mm SAE 45°
TL973	1	5/16"	8 mm SAE 45°
TL974	1	3/8"	10 mm SAE 45°
TL975	1	1/2"	12 mm SAE 45°
TL970	1	4.75 mm	DIN

KS TOOLS
GERMANY

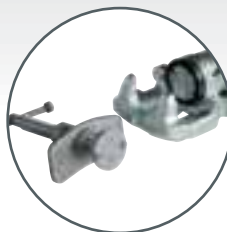

KS TOOLS Brake Piston Wind Back Kit

Complete range of adaptor plates and spindles. Includes left and right turning spindles. Supplied in a robust plastic storage case.

Part No.	Qty	Description
K150.2035	1 Set	18 Piece Set

Adaptor No. - Make and model:

- 0 - GM.
- 2 - CITROËN XM, Xantia, etc.
- 3 - ALFA ROMEO, AUDI, AUSTIN, BMW, FORD, HONDA, JAGUAR, MERCEDES-BENZ, MITSUBISHI, NISSAN, ROVER, TOYOTA, VW.
- 4 - ALFA ROMEO, 164 2.0., FORD, MAZDA, SAAB 9000, SUBARU.
- 5 - Adaptor with 3/8" female square.
- 6 - NISSAN Primera, VW Golf IV.
- 7 - AUDI 80, 90, V8-100, HONDA Prelude, FORD Sierra ABS + Scorpio from 85, NISSAN, Silvia, 1.8 Turbo, ROVER 8000, SAAB 9000, SUBARU L+ Z, VW Golf, Passat.
- 8 - GM.
- 9 - GM.
- G - VAUXHALL Astra.
- Z - RENAULT.
- M - FORD.
- N - SAAB, HONDA.
- K - CITROËN.
- E - NISSAN Maxima.

KS TOOLS
GERMANY

KS TOOLS Brake Piston Return Tool Set

Supplied in a heavy duty plastic storage case.

- The latest comprehensive selection including various adaptor plates & accessories

Part No.	Qty	Description
K150.1970	1 Set	41 Piece Set

30 x Adaptors plates. 2 x Pressure spindle, left and right operation.

2 x Brake block pin punches, with and without pilot pins. 2 x Hexagonal recessed Allen key with handle, SW6 + 7 mm. 4 x Counter hold supporting plates (2 x open and 2 x closed) 1 x Grease dispenser.

KS TOOLS
GERMANY

KS TOOLS Flexi-Head Brake Bleeding Flare Nut Spanner Set

Chrome plated, mirror polished. Flexible 230° angle head.

- Strong heads for high demand.
- Particularly suitable for air conditioning systems, brake hoses, power steering systems.
- The 230° flexible joint makes it possible to work round obstacles.

Part No.	Qty	Sizes
K518.0370	Set of 3	14, 17, 19 mm





BEST SELLER



HORIZON Screw & Stud Extractor Set

For removing broken studs, set screws, pipe and fittings. Drill hole in screw, place extractor in hole and turn anti-clock wise. Supplied in a plastic wallet.

Part No.	Qty	Description
TNH650	1 Set	5 Piece Set

for Screw Sizes: 1/4" & 5/16", 1/2" & 9/16", 3/8", 5/8", 7/16".



KS TOOLS 1/2" Drive Stud Extractor Set

Operate right to left handed. Supplied in a robust plastic storage case.

Part No.	Qty	Description
K152.1100	1 Set	4 Piece Set

4 x Sizes: 6, 8, 10, 12 mm.



KS TOOLS Stud Extractor Set

For screws and bolts M5 - M16. Removable ABS inserts. Supplied in a robust plastic storage case.

Part No.	Qty	Description
K150.1305	1 Set	25 Piece Set

5 x HSS Drills, Ø: 3.2, 4.8, 6.4, 8.0, 8.7 mm. 10 x Bushes, Ø: 4.0, 4.8 (x 3), 6.0, 7.1 (x 3), 9.2, 9.5 mm. 5 x Extractor pins, Ø: 3.2, 4.8, 6.4, 8.0, 8.7 mm. 5 x Extractor nuts, Ø: 10, 11, 13, 14, 17 mm.



KS TOOLS Twist Socket Set

Chrome molybdenum steel, phosphate finish. Supplied in a robust plastic storage case.

- Release and unscrew tight nuts and bolts with damaged threads or rounded heads
- Extra flat and compact design
- Special left handed thread, 6 conical reducing cutting edges
- Drive with either socket, ring or open-ended spanners

Part No.	Qty	Description
K913.3880	1 Set	10 Piece Set

10 x Sizes: 9, 10, 11, 12, 13, 14, 15, 16, 17, 19 mm.



KS TOOLS 1/2" Drive Extra Long Special Twist Socket Set

Chrome molybdenum steel, phosphate finish. Tool length: 145 mm. For use with an impact wrench. Supplied in a robust plastic storage case.

- The aggressive groove design bites itself firmly around the screw or nut, so that between the twist socket and nut head a powerful connection is achieved. The more power on the drive, results in more effective biting of the twist socket profile on the screw or nut head.
- Includes impact bar for removal of extracted nut or bolt from the impact socket.

Part No.	Qty	Description
K913.1290	1 Set	4 Piece Set

3 x Special Twist sockets 1/2": Ø 17, 19, 21 mm. 1 x Impact bar.





Locking Wheel Nut Remover Kit

Simple-to-use kit is capable of removing virtually all locknuts on the market to date, with no damage to the wheel due to the protective steel shroud. Supplied in robust storage case.

- The tool does not rely on strength to work effectively, making it an ideal solution for anybody looking to remove locknuts without the key.

Part No.	Qty	Description
TL1000	1 Kit	11 Piece Set
TL1000C	1	Replacement Blade C

Kit contents: 1 x Impact driver, 1 x L.N.R. body, 1 x Blade A, 1 x Blade B, 1 x Blade C, 1 x Centre punch, 1 x Hand protection ring, 1 x Instruction manual.



MAYHEW 'Dominator' HD Hook & Pick Set

Each tool length is up to 250 mm. Supplied in a clamshell.

- Used for a wide variety of applications, such as automotive and electrical work in confined spaces, scribing lines, O-ring and cotter pin removal, and to break radiator connections.
- Made of larger shank steel for heavy-duty applications.
- Black oxide finish for additional rust protection.

Part No.	Qty	Description
TN60000	1 Set	4 Piece Set

4 x Types: Scratch Awl, 90° Hook, Curved Hook, Complex Hook.



MAYHEW 'Dominator' Mini Hook & Pick Set

Each tool length is up to 165 mm. Supplied in a clamshell.

- Used for pulling clips, rings, wires, gaskets, washers and other small parts
- The blade extends throughout the handle and is fully heat treated

Part No.	Qty	Description
TN60003	1 Set	4 Piece Set

4 x Types: Scratch Awl, Curved Hook, 90° Hook, Complex Hook.



KS TOOLS Hook & Pick Set

Each tool length is up to 140 mm. Ideal for removing and fitting O-rings, cotter pins, seals and bushes.

Part No.	Qty	Description
K550.1045	1 Set	4 Piece Set

1 x Hook and pickup, straight. 1 x Hook and pick up, S-form.
1 x Hook and pick up, 90°. 1 x Hook and pick up, round.



BEST SELLER

BAHCO Trim Clip Tool

Blade made of high performance alloy steel. Hardness: 40-46 HRC.

Part No.	Qty	Shaft Length	Overall Length
TL125	1	175 mm	245 mm



KS TOOLS Plastic Wedge Set

Useful assortment of different wedges and clip removal tools.

- Useful assortment of different wedges and clip removal tools.
- Ideal for removal of paneling, trims and window trims, at the same time, reducing paint work damage: e.g. plastic trims, internal door paneling, plugs, protective caps, actuation knobs etc.

Part No.	Qty	Description
K911.8120	1 Set	5 Piece Set

1 x Standard clip remover. 1 x Trim wedge, narrow model. 1 x Dual clip remover. 1 x Bumper trim wedge, wide model. 1 x Clip remover.



LASER Headlight Adjustment Kit

S2 steel blades. Suits many vehicle models. Screwdriver heads: T25, 7 mm Hex, 6 mm Hex.

- Handle can be used as standard screwdriver or as a T-handle for extra leverage and easier access.

Part No.	Qty	Description
TL7403	1 Set	4 Piece Set



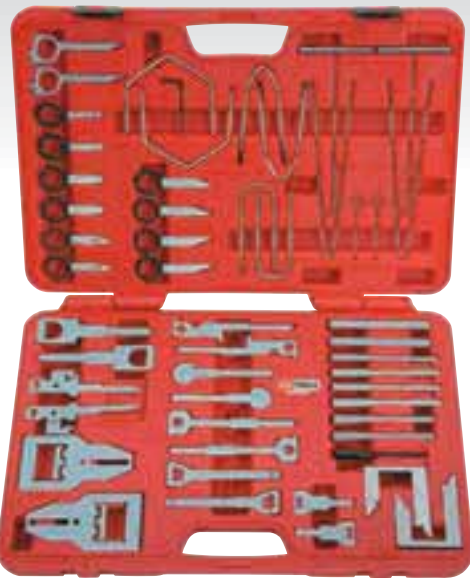

KS TOOLS Master Radio Installation & Removal Set

Tool set for safe and damage free removal of radios from car dashboards/consols. Supplied in a robust plastic storage case.

Part No.	Qty	Description
K500.1380	1 Set	52 Piece Set

For following manufactures and radio types:
BECKER from 2002 (new), BECKER, PORSCHE, MERCEDES BENZ, BLAUPUNKT from 2002 (new), BLAUPUNKT, GRUNDIG, VW, AUDI, FORD, BMW, BMW, VAUXHALL - Inbus, CLARION (old), CLARION (new), FIAT BRAVA, KENWOOD I to 1998, II 1998 - 2001, III from 2002, KENWOOD MASK, MERCEDES BENZ & BMW, PANASONIC, PANASONIC 2006, PIONEER & JVC, SONY I to 2001, SONY II from 2002, I DIC 2005, SKODA from 2002 (new), VAUXHALL double bearing bit. VW, VW, AUDI, BECKER, MERCEDES BENZ.



BEST SELLER

KS TOOLS 3/8" Drive Cup Form Oil Filter Socket Set

Supplied in a robust plastic storage case.

- 3/8" square drive or outer hexagon diameter 21 mm
- Special socket shape construction ideal for tight places
- Where necessary filters or filter caps can be tightened exactly according to manufacturers torque settings

3/8"

Part No.	Qty	Description
K150.9310	1 Set	16 Piece Set

Suitable for: AUDI, BMW, FIAT, GM, LANCIA, MERCEDES BENZ, NISSAN, OPEL, PORSCHE, RENAULT, SAAB, VOLVO, VW and other makes. Also suitable for VOLVO Plastic oil filter.
14 x Oil filter sockets: Diameter 66 mm (6 grooves), 76 mm (8 grooves), 76 mm (12 sided), 76 mm (14 sided), 86 mm (16 sided), 86 mm (18 sided), 92 mm (10 sided), 93 mm (15 sided), 93 mm (45 grooves), 96 mm (18 grooves), 106 mm (15 sided), 108 mm (15 sided), 108 mm (18 grooves), 74/76 mm (15 sided).
1 x Oil filter wrench, adjustable 65 - 138 mm.
1 x Adaptor 1/2" F to 3/8" M.



Oil Filter Wrenches - Cam Type

3/8"

Part No.	Qty	Range	Drive
TNH276	1	2 3/8" - 3 3/4"	(61 - 95 mm) 3/8" Drive or 3/4" Hex



Oil Filter Wrenches - Spider Type

3/8"

Part No.	Qty	Range	Drive
TNH277	1	2 3/8" - 4 3/4"	(61 - 121 mm) 3/8" Drive



BEST SELLER

Oil Filter Wrench - Heavy Duty Cordura Strap

For high torque requirements. Strap length: 630 mm (2 ft).

3/8" 1/2"

Part No.	Qty	Range	Drive
TNH278	1	Up to 9" Ø	(228 mm) 3/8" or 1/2" Drive



BEST SELLER

Oil Filter Wrench - Self-adjusting.

Part No.	Qty	Capacity
TNH297	1	60 - 152 mm (2 1/4" - 6")



Oil Filter Wrenches - Swivel Type

Part No.	Qty	Range
TNH259	1	2 3/8" - 2 7/8" (60 - 73 mm) Suitable for 2 1/2" MAZDA/TOYOTA Filters
TNH253	1	2 7/8" - 3 1/4" (73 - 83 mm)
TNH251	1	3 7/16" - 3 3/4" (87 - 95 mm)
TNH255	1	4" - 4 3/8" (102 - 111 mm)



Exhaust & Tailpipe Cutter

With cutting wheels on each roller for smooth tracking. Effective in hard-to-reach areas.

Part No.	Qty	Capacity	
TNH770	1	19 - 76 mm Ø	(3/4" - 3 1/4")



LASER Wiper Arm Puller Set

Suits numerous vehicles.

- Supplied with 2 sets of legs.
- Maximum reach: 50 mm.
- Width: 60 mm.

Part No.	Qty	Description
TL7402	1 Set	3 Piece Set



Thread Repair Files

For defect inner and outer threads. Suitable for the repair of both right as well as left hand threads with different diameters. Length: 230 mm.

Part No.	Qty	Thread Type
TL7635	1	Metric Sizes

8 x Pitches: 0.80, 1.00, 1.25, 1.50, 1.75, 2.00, 2.50, 3.00 mm.

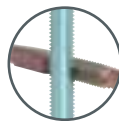

Part No.	Qty	Thread Type
TL7636	1	Imperial Sizes

8 x Pitches: 24, 20, 18, 16, 14, 12, 11, 10 Pitch Per Inch.



KS TOOLS Puller For Battery Clamps and Windscreen Wiper Arms

Self centre puller for small components, especially for automotive applications.

- Fine adjustable extraction using the knurled wheel.
- Take up: 0 - 50 mm.
- Spindle with fine thread & T-bar, adjustable depth: 0 - 20 mm.
- Freely swiveling end piece for careful contact to the component.
- Total length: 100 mm.



Part No.	Qty	Description
K700.1190	1	Battery Clamp Puller



KS TOOLS Windscreen Wiper Puller Type 1

Removes most windscreen wipers.

Hand screw drive.
Jaw width: 16 mm.
Working height: 28 mm.



Part No.	Qty	Description
K700.1193	1	Windscreen Wiper Puller



Windscreen Jet Cleaning Tool

Part No.	Qty	Description
TL1300	1	Washer Jet Tool



KS TOOLS Windscreen Washer Jet Cleaning & Alignment Tools

Double ended practical tool for cleaning washer jets at one end and hardened tip to adjust the jet at the other. Length: 95 mm. Complete with pocket clip.

Part No.	Qty	Description
K550.1022	1	Washer Jet Tool



KS TOOLS 2-in-1 Telescopic Magnetic Pickup Tool and Needle

Extension Range: 150 - 675 mm.

- Designed for the retrieval of small pieces with the magnetic end.
- Protection cap for the needle, which can also be used for cleaning water jet holes.

Part No.	Qty	Description
K550.1001	1	Pickup Tool and Needle





KS TOOLS Long Knife For Scraping

Stable aluminium knife with non-slip grip with trapezoid blade. For use with standard trapezoid and hook blades. Blade magazine in knife.

Part No.	Qty	Length
K140.2290	1	470 mm



KS TOOLS Pull Knife and 25 mm Blade

Length: 130 mm.

- Robust pull knife with flexible pull handle for better handling.
- PVC covered body, cable, and handle to prevent scratches to paint work.
- Quick change blade system without the use of a tool.

Part No.	Qty	Description
K140.2248	1	Pull Knife

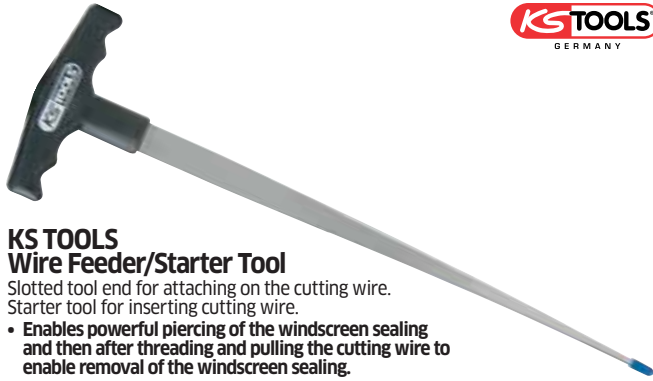

KS TOOLS Wire Feeder/Starter Tool

Slotted tool end for attaching on the cutting wire. Starter tool for inserting cutting wire.

- Enables powerful piercing of the windscreen sealing and then after threading and pulling the cutting wire to enable removal of the windscreen sealing.
- The spring steel blade is pushed from inside, through the resin bond.

Part No.	Qty	Length
K140.2206	1	340 mm



KS TOOLS Windscreen Cutting Wire

Stainless steel. Length: 22.5m. Operates like a saw.

- Highly flexible and tough wire, especially suitable for use in difficult places when cutting bonding adhesive strip.

Part No.	Qty	Description
K140.2214	1	Square Stainless Steel Wire



KS TOOLS Suction Holder Set

Plastic coated steel wire with 2 PVC suction cups.

- Holds side windows during removal of the windscreen winder to prevent slipping.
- Also keeps freshly bonded windows from moving.

Part No.	Qty	Description
K140.1060	1 Set	2 Piece Set



KS TOOLS Windscreen Cutting Wire

Made from 3 brass plated steel wires, twisted to form one wire. Length: 22.5m. Operates like a saw.

- Highly flexible and tough wire, especially suitable for use in difficult places when cutting bonding adhesive strip.

Part No.	Qty	Description
K140.2211	1	Braided 0.8 mm Wire



KS TOOLS Single Handed Suction Lifter

For lifting, supporting and holding. Suitable for any flat surface. Load capacity: 8 kg.

- For use with installation of rear view mirrors and for use in sanitary installations.

Part No.	Qty	Description
K140.1015	1	70 mm Ø Suction Lifter



BAHCO Windscreen Cutting Wire Handles

Aluminium construction with black PVC handle for increased comfort and a safe and reliable grip when pulling the cutting wire.

Part No.	Qty	Description
TL132	1 Pair	Wire Handles



MAYHEW Multi-Telescopic Set with Magnifier Glass

Supplied in a compact storage case.

Part No.	Qty	Description
TN17720	1 Set	5 Piece Set

5 Pieces: 1 x Magnifier with Coupler, 1 x SS Antenna with Coupler, 1 x Mirror with Coupler, 1 x 14lb Magnet with Coupler, 1 x 3lb Magnet with Coupler.



Magnetic Pick Up Tools

Part No.	Qty	Colour
TL1310	1	Green
TL1320	1	Orange

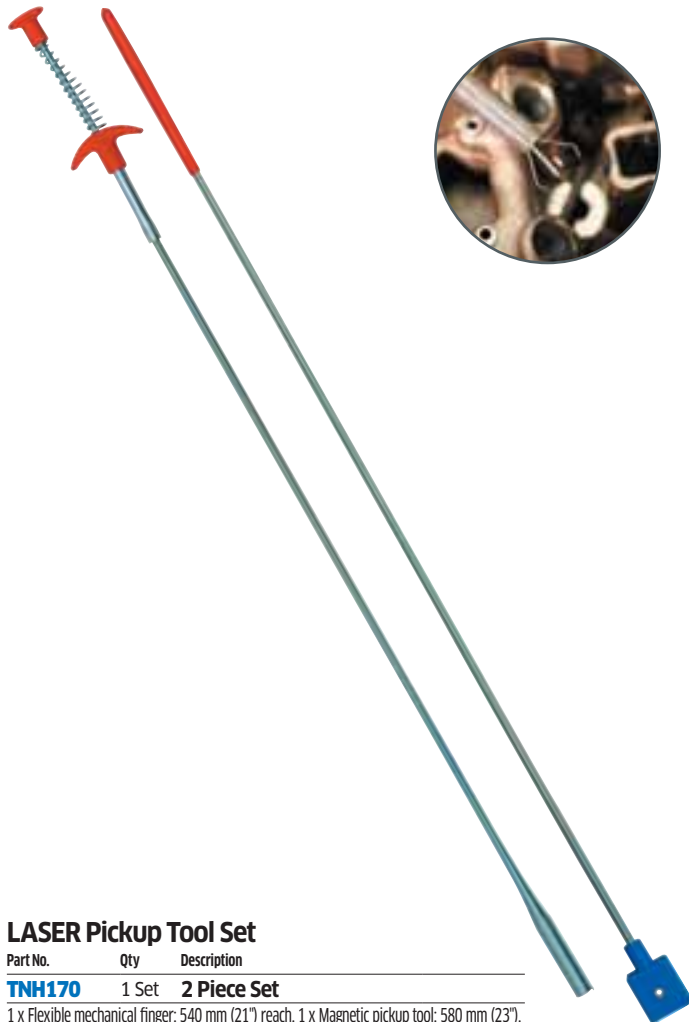

LASER Pickup Tool Set

Part No.	Qty	Description
TNH170	1 Set	2 Piece Set

1 x Flexible mechanical finger: 540 mm (21") reach. 1 x Magnetic pickup tool: 580 mm (23").



BEST SELLER

Inspection Mirror - Round Shape

Telescopic handle. Adjustable mirror angle.

Part No.	Qty	Mirror Size	Telescopic Range
TNH25C	1	57 mm Ø	(2 1/4") 140 - 527 mm



Inspection Mirror - Oval Shape

Telescopic handle with pocket clip and magnet. Adjustable mirror angle.

Part No.	Qty	Mirror Size	Telescopic Range
TNH2TM	1	25 x 50 mm	(1" x 2") 140 - 527 mm



KS TOOLS Telescopic Pickup Tool

Made from V2A, energy protection cap increases the magnetic power by approx 35% and prevents lateral contact. Extension Range: 178 - 860 mm



Part No.	Qty	Magnetic Capacity
K550.1002	1	Up to 5.0 kg



KS TOOLS Telescopic Pickup Tool with Rotating Head

Made from V2A, energy protection cap increases the magnetic power by approximately 35% and prevents lateral contact. Extension Range: 178 - 860 mm.



Part No.	Qty	Magnetic Capacity
K550.1003	1	Up to 5.0 kg



TENG TOOLS Telescopic Magnetic Pickup Tool

Max extension 550 mm with very powerful magnet. Can be used for retrieving nuts and bolts, etc.



Part No.	Qty	Description
TSD501	1	Pick-Up Tool



Magnetic Pickup Tool

Telescopic with pocket clip. Picks up to 1 kg (2.2 lb).

Part No.	Qty	Magnetic Capacity
TN9425	1	1 kg (2.2 lb)



KS TOOLS 2-in-1 Telescopic Magnetic Pickup Tool and Needle

Extension Range: 150 - 675 mm.

- Designed for the retrieval of small pieces with the magnetic end.
- Protection cap for the needle, which can also be used for cleaning water jet holes.



Part No.	Qty	Description
K550.1001	1	Pickup Tool and Needle





ARCTIC HAYES Digital Multimeter with Temperature Probe

Complies with EN61010-1 insulation. Class 2, double insulation Measure and test DC voltage, AC and DC current. Supplied with K-type temperature probe with adapter and a 9V battery.

- **Overload category:** CATIII 600V
- **Display:** 2000 counts LCD display
- **DC voltage:** (auto-ranging except 200mV)
- **DC current:** (auto-ranging for uA and mA)
- **AC current:** (auto-ranging for uA and mA)
- **Temperature range up to 760°C**

Part No.	Qty	Description
TL200	1	Digital Multimeter



NEW



RING Multi-Function Automotive Tester

Suitable for 6V, 12V and 24V vehicles. Multi-function automotive tester, designed specifically to find electrical automotive faults. Features a voltage check, with a traffic light result indicator, giving an instant and easy-to-read assessment of the battery charge levels. Assesses circuit voltages. Uses 3 x AA Batteries (NOT included). Supplied in robust storage case.

- **Rapid current testing up to 80A without removing fuses**
- **Current adapter for in-line current testing**
- **Normal and Smart 12/24V alternator test for checking vehicle charging system**
- **12/24V starter test checks battery during engine cranking**
- **Frequency and duty cycle settings aid testing of sensors**
- **Continuity and resistance modes for locating wiring faults**

Part No.	Qty	Dimensions	Voltage DC	Output DC
ERMM500	1	262 x 350 x 95 mm	0-50V	0-80A



NEW



KS TOOLS 6-400V AC/DC Universal Voltage Tester

Rotating field and phase display, fully insulated. DIN 0680. For professional, multi step testing of voltage and polarity. LED Display. Power consumption: 140 mA. Allowable switch on time: 30 seconds.

Part No.	Qty	Description
K550.1501	1	AC/DC Voltage Tester

Frequency range: 0 - 100 Hz. Protection class: IP40. AC -> Voltage range 6 - 50 - 120 - 230 - 400V ~
DC -> Voltage range 6 - 50 - 120 - 230 - 400V ==



LITTELFUSE Blade Fuse Extractor & Tester

For testing ATOF® (standard type), MINI® & Low Profile MINI® blade fuses.

Part No.	Pack of	Description
EFBX	3	Extractor/Testers



Circuit Tester

Part No.	Qty	Description
TL9370	1	Circuit Tester



BEST SELLER



KS TOOLS 150-250V Voltage Tester

Fully insulated. DIN 0680. Transparent handle. Nickel plated blade, slotted: 3.0 mm.

Part No.	Qty	Description
K911.2188	1	Voltage Tester



BEST SELLER

Brake Fluid Tester

RoHS compliant. Quickly identifies percentage of water in brake fluid. Complete with 1 x AAA battery.

- **Essential for regular safety checks on brake systems.**
- **Quick and simple to use.**
- **5 x LED Colour coded LEDs show level of water.**

Part No.	Qty	Description
TL7215	1	Brake Fluid Tester

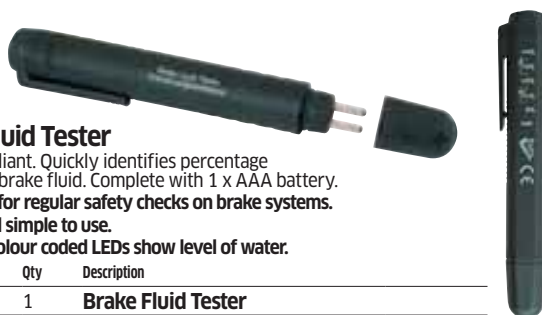

KS TOOLS Refractometer - Optical Tester for Antifreeze and Battery Acid

For quick precise testing the antifreeze content in coolant, windscreen liquid as well as battery acid. High quality aluminium version. Supplied in a robust case.

- 5 scales for:
- **Cooling water Propylene:** 0° to -50°C.
 - **Cooling water Ethylene:** Temperature consistency (measuring range 0° to -50° C).
 - **Screen washer water:** Antifreeze (measuring range 0° to -40° C)
 - **Adjustable calibration feature.**
 - **With ATC Automatic Temperature Compensation which enables use at ambient temperature of under 10°C (Bi-metallic measurement correction).**

Part No.	Qty	Description
K550.1290	1	Refractometer

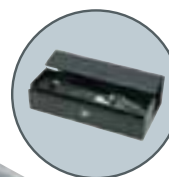

BEST SELLER

Ethylene Glycol Anti-Freeze Tester - Disc Type

Accurate at all temperatures. Tests coolant hot or cold. Protection scale printed in °F and °C. Sixth disc shows overprotection and loss of cooling efficiency. **NOT** suitable for use with propylene glycol.

Part No.	Qty	Description
TL106	1	Ethylene Glycol Anti-Freeze Tester



484



484

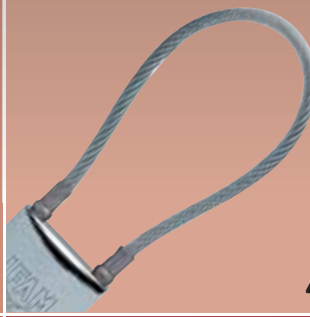

485



485



486



487



Storage + Security



487



487



488

- 484 Padlocks
- 485 Security Locks
- 485 Security Chains
- 486 High Security Locks
- 487 Hasp + Staples
- 488 Tool Storage
- 489 Storage Containers
- 489 Storage Cabinets
- 490 Storage Bins
- 494 Steps + Trolleys
- 495 Packing Materials



488

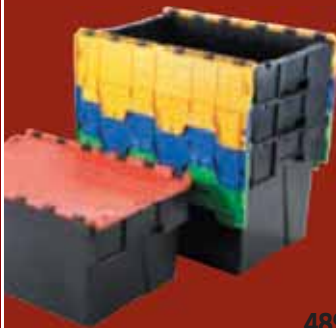

489



489



489

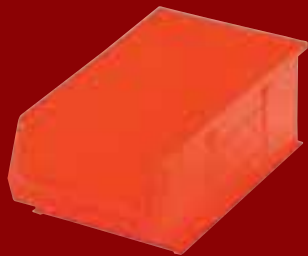

490



491



494



495





BEST SELLER



Padlocks - Brass

All-brass body with hardened steel clasp. Standard shackle. Supplied with 3 keys.

Part No.	Pack of	Body Width
PAD30	1	32 mm
PAD38	2	38 mm
PAD50	2	50 mm
PAD63	2	63 mm



IFAM Padlocks - Brass

Extruded brass body. Hardened carbon-nitride, chrome plated steel shackle. Pick proof. Supplied with 2 keys.

Part No.	Qty	Body Width
PAD230	1	30 mm
PAD240	1	40 mm
PAD250	1	50 mm
PAD260	1	60 mm



Keyed-Alike Padlocks - Brass

All-brass body with hardened steel clasp. Standard shackle.

- Each padlock is supplied with 3 keys that will open other padlocks of the same Part No./size.
- Ideal when used to secure gates or tool boxes.

Part No.	Pack of	Body Width
PAD130	1	32 mm
PAD138	6	38 mm
PAD150	6	50 mm
PAD163	1	63 mm



IFAM Keyed-Alike Padlocks - Brass

Extruded brass body. Hardened carbon-nitride, chrome plated steel shackle. Pick proof. Supplied with 2 keys.

- Each padlock is supplied with 2 keys that will open other padlocks of the same Part No./size.
- Ideal when used to secure gates or tool boxes.

Part No.	Qty	Body Width
PAD230K	1	30 mm
PAD240K	1	40 mm
PAD250K	1	50 mm
PAD260K	1	60 mm



BEST SELLER



Padlocks - Brass, Long Shackle

All-brass body with hardened steel clasp. Long shackle. Supplied with 3 keys.

Part No.	Pack of	Size	Shackle Height
PAD4	2	38 mm	67.5 mm
PAD5	2	50 mm	73.5 mm



IFAM Long Shackle Padlocks - Brass

Extruded brass body. Hardened carbon-nitride, chrome plated steel shackle. Pick proof. Supplied with 2 keys.

Part No.	Qty	Body Width
PAD240LS	1	40 mm
PAD250LS	1	50 mm



Padlocks - Steel

Galvanised steel body with brass cylinder, hardened steel clasp. Standard shackle. Supplied with 3 keys.

Part No.	Pack of	Size
PAD1	2	38 mm
PAD2	2	50 mm
PAD3	2	63 mm



IFAM Padlocks - Stainless Steel

Chrome plated extruded brass body. Stainless steel shackle. Spring and pins, double locking mechanism. Treated against rust. Supplied with 2 keys.

Part No.	Qty	Body Width
PAD330	1	30 mm
PAD340	1	40 mm
PAD350	1	50 mm



IFAM Security Cable Shackle Padlocks - Stainless Steel

Chrome plated extruded brass body. Spring and pins, double locking mechanism. Treated against rust. Supplied with 2 keys.

Part No.	Qty	Body Width
PAD350C	1	50 mm



Spiral Cable Lock

Supplied with 2 keys.

Part No.	Qty	Length
PAD21	1	1.5 m



IFAM Padlock - Combination

Brass body, hardened carbon-nitride and chrome plated. Double locking system, combination low with master reset key.

Part No.	Qty	Body Width
PAD15	1	50 mm



Chain Lock

Nickel plated, hardened body and pins. Hacksaw and bolt cutter resistant, virtually impregnable. Complete with 2 keys.

Part No.	Qty	Description
PAD110	1	Chain Lock
PAD110S	1 Set	Chain Lock & 1 m Security Chain



Hardened Security Chain

Square link with blue thermo wrapped sheath. Hacksaw and bolt cutter resistant.

Part No.	Qty	Size
PAD23	1	10 mm x 1 m

Spiral Security Cable

Double loop cable.

Part No.	Qty	Length
PAD22	1	2 m





IFAM Circular Discus Padlock- Stainless Steel

Bolt-cutter proof. Can be used with U-shaped hasp set (PAD9), Outdoor use. Supplied with 2 keys.

Part No.	Qty	Body Width
PAD195	1	70 mm



Spacelock

Can be used with U-shaped hasp set (Part No. PAD9).

Part No.	Qty	Description	Diameter
PAD95	1	5-Pin Model	70 mm



Close Shackle Padlock - 6 Lever

Double plated, Hardened shackle.

Part No.	Qty	Body Width
PAD16	1	63 mm



5-Lever Padlock

High security closed shackle with 2 keys.

Part No.	Qty	Description
PAD6	1	5-Lever Padlock



IFAM Shutter Padlock - Brass

Solid Brass body, Carbon-nitride hardened. Chrome plated Steel shackle, ball bearing lock. Automatic locking system, Supplied with 2 keys

Part No.	Qty	Body Width
PAD14	1	70 mm



Shutter Padlock - Brass

All-brass body with hardened steel clasp. Standard shackle. Supplied with 3 keys.

Part No.	Qty	Body Width	Shackle
PAD17	1	70 mm	Steel

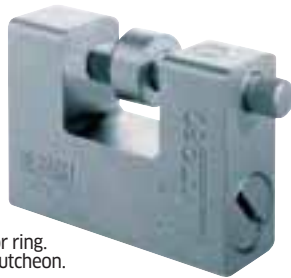

IFAM High Security Block Lock - Steel

Solid steel alloy. Rust resistant. Shackle protector ring. Lever and torsion resistant. 4 mm key hole escutcheon. Supplied with 3 dimple keys.

• Insurance rated to CEN5 - EN12320.

Part No.	Qty	Body Width
PAD25	1	50 mm



Armoured Padlock - Brass

Chrome plated. Supplied with 2 keys.

Part No.	Qty	Body Width
PAD170	1	80 mm



Heavy Duty Safety Hasp & Staple

Part No.	Qty	Size
PAD12	1	190 x 55 mm



Medium Duty Safety Hasp & Staple

Part No.	Qty	Size
PAD26	1	140 x 40 mm



Vertical Locking Bar

Part No.	Qty	Size
PAD13	1	150 x 110 mm



Hasp & Staple

Heavy galvanized with brass pin.

Part No.	Qty	Length
PAD7	1	200 mm



U-Shaped Hasp Set

Complete with fastenings.
For use with Part No. PAD95 Space-Lock (NOT included).

Part No.	Qty	Description
PAD9	1	U-Shaped Hasp Set

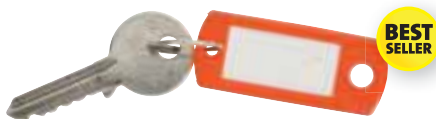

Assorted Pack of Keyring Indicators

Part No.	Pack of
AP40	48 Pieces

8 x Colours: Black, Light Blue, Dark Blue, Green, Pink, Purple, Red, Yellow.



Security Pull Seals - Red

Polypropylene plastic seals uniquely numbered in sequential order (i.e. D 013001 - D 0141000). Tie locking length: 160 mm.
Flag Dimensions (W x L): 19 x 36 mm.

Part No.	Qty	Description
PAD20R	Box of 1,000	Security Pull Seals



Tool Clips

Zinc plated steel. Closed type.

Part No.	Pack of	Size	
TL430	100	10 - 12 mm	3/8"
TL431	100	13 - 14 mm	1/2"
TL432	100	16 - 19 mm	5/8"
TL433	100	25 - 27 mm	1"
TL434	100	32 - 34 mm	1 1/4"



BEST SELLER

Assorted Pack of Tool Clips

Closed type.

Part No.	Pack of
AP53	50 Pieces

5 x Sizes: 10 - 12, 13 - 14, 16 - 19, 25 - 27, 32 - 34 mm



Gripper Wrench Organizer

For use in toolboxes or on the wall.
Folding space saver handle.

Part No.	Qty	Holds Up To
TL8050	1	12 Spanners



Socket Rails

Supplied complete with 16 spring steel socket clips.
(Sockets NOT included).

Part No.	Qty	Drive	Length
TL8014	1 Set	1/4"	410 mm
TL8038	1 Set	3/8"	410 mm
TL8012	1 Set	1/2"	410 mm





TENG TOOLS Magnetic Bits Tray

Stainless steel with plastic enclosed magnet which does not damage vehicle paint work. Can be secured on its side as well as upside down.



Part No.	Qty	Description
T580	1	Bits Tray



TENG TOOLS Magnetic Bits Tray - Deep

Large stainless steel tray with two rubber protected magnets to avoid damage to vehicle paint work. Depth gives extra space to store parts and bulkier items, even upside-down.

Part No.	Qty	Description
T580A	1	Deep Bits Tray



TENG TOOLS Magnetic Tool Rail

Dimensions: 457 x 52 x 17 mm. Weight: 0.6 kg.

- 6 individual magnets each with a capacity of 450 grams combined in a rail especially designed for fixing to TENG TOOLS roller cabinets.
- Suitable for wall mounting or other tool boxes.
- Ideal for hanging up tools while working.



Part No.	Qty	Description
TTC-MAG	1	Tool Rail



TENG TOOLS Non-Slip Tool Mat

Use as a drawer liner in all TENG TOOLS storage boxes and cabinets or on any flat or curved surface as a tool mat. Can be cut to any size.



Part No.	Qty	Size
TTC-MAT	1	450 mm x 2 m Roll



TENG TOOLS Tool Tray

Add-on tool tray with 7 separate compartments. Dimensions: 265 x 142 x 50 mm. Weight: 0.29 kg. Supplied in a tool tray.

Part No.	Qty	Description
TTT01	1	Empty Tool Tray

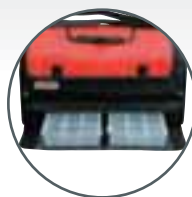

KS TOOLS 'Smart Bag' Universal Tool Case

Dimensions: D 425 x W 240 x H 280 mm. Weight: 2.37 kg. Supplied empty.

- Made from strong polyester material.
- External pockets, separate compartment for storage of small components in the bottom of the case, ideal for assorted boxes.
- Includes padded carry strap.



Part No.	Qty	Description
K850.0300	1	'Smart Bag' Tool Case



KS TOOLS Plastic Tool Box

Dimensions: D 450 x W 240 x H 260 mm.

- Multi-functional for various storage possibilities
- Capacity up to 10 kg
- Made from robust plastic

Part No.	Qty	Description
K850.0505	1	Plastic Tool Box



KS TOOLS Tool Case Trolley with Telescopic Handle

Dimensions L x B x H: 500 x 280 x 400 mm. Weight: 2.2 kg. Load Max: 30 kg.

- 8 different size outer pockets, with hook and loop fastening.
- Sturdy zipper.
- 15 inner pockets, different sizes.
- Robust plastic base.
- Wide rollers and stand feet for stand alone safety.



Part No.	Qty	Description
K850.0305	1	Tool Case Trolley



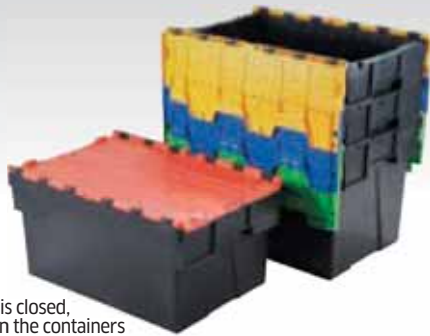

BARTON Attached Lidded Euro Containers

Can be stacked when the lid is closed, or nested to save space when the containers are not in use and the lid is open.

- Label/card holder included
- Temperature resistant from -20°C to 40°C

* Please allow 5-7 days delivery on this product

Part No.	Qty	Colour	External (L x W x H)	Capacity
SB85B *	2	Blue	600 x 400 x 310 mm	56 Litres
SB85G *	2	Green	600 x 400 x 310 mm	56 Litres
SB85R *	2	Red	600 x 400 x 310 mm	56 Litres
SB85Y *	2	Yellow	600 x 400 x 310 mm	56 Litres
SB86B *	2	Blue	600 x 400 x 365 mm	65 Litres
SB86G *	2	Green	600 x 400 x 365 mm	65 Litres
SB86R *	2	Red	600 x 400 x 365 mm	65 Litres
SB86Y *	2	Yellow	600 x 400 x 365 mm	65 Litres
SB87B *	2	Blue	600 x 400 x 400 mm	77 Litres
SB87G *	2	Green	600 x 400 x 400 mm	77 Litres
SB87R *	2	Red	600 x 400 x 400 mm	77 Litres
SB87Y *	2	Yellow	600 x 400 x 400 mm	77 Litres



BARTON 'Safestore' Hazardous Substance Cabinets

Constructed from 20 gauge mild steel with welded seams. High visibility polyester powder coated in yellow with Highly Flammable warning labels. Fitted with a two point lockable handle. Reinforced doors prevent distortion. Adjustable shelf at 25 mm pitches.

- Designed to provide safe storage of flammable liquids, chemicals, paints and other hazardous substances
- NOT fire or explosion proof but are designed to reduce risk to a minimum

* Please allow 7-10 days delivery on this product

Part No.	Qty	Dimensions (H x W x D)	Complete with
SB50 *	1	915 x 457 x 457 mm	1 Shelf
SB51 *	1	915 x 915 x 457 mm	1 Shelf
SB52 *	1	1829 x 915 x 457 mm	3 Shelves

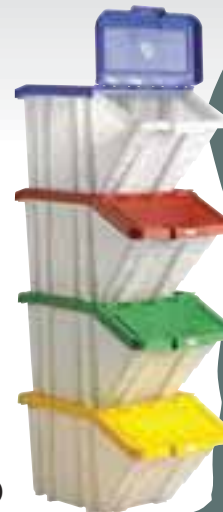

BARTON Multi-Functional Containers

Manufactured from polypropylene. Robust multi-functional sorting storage bins complete with removable hinged lids. Dimensions (H x W x D): 345 x 400 x 635 mm.

- Stackable/nestable (maximum total stack height is 4)
- Maximum total stack load: 45 Kg

* Please allow 5-7 days delivery on this product

Part No.	Qty	Lid Colour	Capacity
SB70 *	4	Mixed Colours	50 Litres
SB70B *	4	Blue	50 Litres
SB70R *	4	Red	50 Litres
SB70G *	4	Green	50 Litres
SB70Y *	4	Yellow	50 Litres



BARTON Extra Wide Shelving System c/w Space Bin Containers

Boltless heavy duty hand loaded shelving system. Galvanised frames beams with chipboard shelves complete with 50 Ltr capacity polypropylene container bins. Overall Dimensions (H x W x D): 1800 x 1200 x 450 mm. Max load per shelf: 265 Kg.

- Ideal storage solution for larger products or multiple storage or bulk items
- Large open fronted bins for easy access
- Space bin containers are both stackable and nestable when not in use

* Please allow 5-7 days delivery on this product

Part No.	Qty	Description
SB62 *	1 Kit	Wide Shelving System c/w 8 Space Bins
SB60 *	1	Wide Shelving System (Without Bins)





BARTON Storage Bins - TC2

Dimensions (D x W x H):
165 x 100 x 75 mm (6 1/2" x 4" x 3").
Sturdy polyethylene bins with label holders.
Compatible with most standard shelving systems.



Part No.	Qty	Colour
SB21BU	20	Blue
SB21RE	20	Red



BARTON Storage Bins - TC3

Dimensions (D x W x H):
240 x 150 x 132 mm (9.5" x 6" x 5").
Sturdy polyethylene bins with label holders.
Compatible with most standard shelving systems.

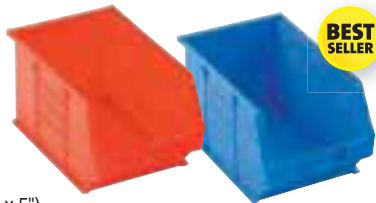

Part No.	Qty	Colour
SB22BU	10	Blue
SB22RE	10	Red



BARTON Storage Bins - TC4

Dimensions (D x W x H):
350 x 205 x 132 mm (13 3/4" x 8" x 5").
Sturdy polyethylene bins with label holders.
Compatible with most standard shelving systems.

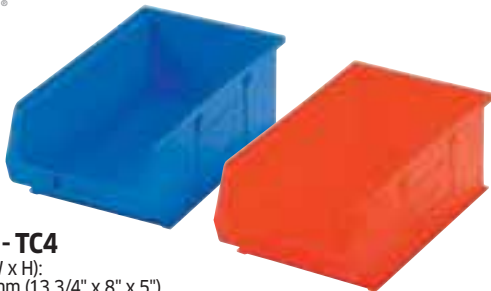

Part No.	Qty	Colour
SB23BU	10	Blue
SB23RE	10	Red



BARTON Mobile Single Sided Storage System

Units are finished epoxy powder coated blue with silver/grey base. Trolleys are supplied as standard with 100 mm diameter wheels/castors (2 fixed/2 swivel) non-marking rubber tyred and enable a safe load to be manoeuvred with ease. Supplied with 40 x TC2 Red & 40 x TC2 Blue storage bins.

- Individual Bin Sizes: 165 x 100 x 75mm
- All containers are supplied with I.D labels
- * Please allow 5-7 days delivery on this product



Part No.	Qty	Overall Dimensions (W x D x H)
SB95 *	1 Kit	1160 x 1000 x 530 mm

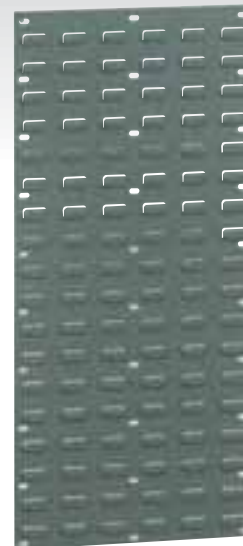
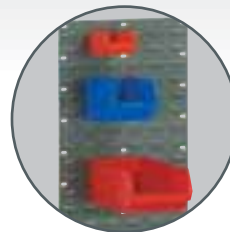

BARTON Wall Mountable Louvred Panel

Precision formed heavy gauge steel with silver/grey epoxy powder coated finish. (Storage bins shown are NOT included). Wall fixings **NOT** included.

- Unique double indented louvre provides extra strength.

Part No.	Qty	Size (W x H)
SB35	1	457 x 946 mm (18" x 37 1/4")

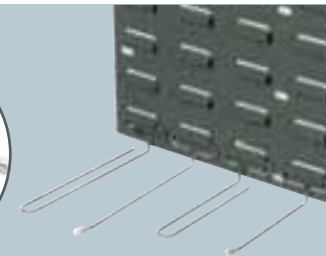

BARTON Wire Hangers (Spigots)

Manufactured from 3.6 mm wires. Single wire type c/w a rubber end cap for safety. Compatible with most standard louvred systems. Suits: SB35, SB4, SB5, SB13, SB14, SB15. (Tools shown are **NOT** included)

Part No.	Qty	Type	Length
SB30	10	Single Wire	152 mm
SB31	10	Single Wire	203 mm
SB32	10	Double Wire	152 mm
SB33	10	Double Wire	203 mm



BARTON Hanging Rods

For tubing, fan-belts, exhaust clamps etc.

Part No.	Pack of	Length
SB34	2	300 mm (12")



BEST SELLER



SSI SCHAEFER Louvred Panels

Manufactured from 15 gauge steel with silver/grey finish. (Boxes shown **NOT** included)

Part No.	Qty	Size (W x H)	
SB4	1	475 x 630 mm	(18 3/4" x 24 3/4")
SB15	1	475 x 946 mm	(18 3/4" x 37")
SB5	1	475 x 1854 mm	(18 3/4" x 73")
SB13	1	610 x 630 mm	(24" x 24 3/4")
SB14	1	610 x 1245 mm	(24" x 49")



BARTON Standard Shelving System c/w Storage Bins

Boltless heavy duty hand loaded shelving system. Galvanised frames beams with chipboard shelves. Overall Dimensions (H x W x D): 1800 x 900 x 450 mm
Max load per shelf: 265 Kg.

- Fully adjustable shelving.
- * Please allow 5-7 days delivery on this product.

Part No.	Qty	Description
SB63BU*	1 Kit	Shelving Unit c/w 40 x SB23BU Bins
SB63RE*	1 Kit	Shelving Unit c/w 40 x SB23RE Bins
SB61*	1	Shelving System Only (without Bins)

BEST SELLER



SSI SCHAEFER Storage Bins - LF211

Dimensions (D x W x H): 160 x 95 x 75 mm (6 1/4" x 3 3/4" x 3"). Sturdy polyethylene bins with label holders. Compatible with most louvre systems.

Part No.	Qty	Colour
SB1BU	10	Blue
SB1RE	10	Red
SB1DIV	10	Dividers

SSI SCHAEFER Storage Bins - LF221

Dimensions (D x W x H): 230 x 140 x 130 mm (9" x 5 1/2" x 5"). Sturdy polyethylene bins with label holders. Compatible with most louvre systems.

Part No.	Qty	Colour
SB2BU	10	Blue
SB2RE	10	Red
SB2DIV	10	Dividers

SSI SCHAEFER Storage Bins - LF321

Dimensions (D x W x H): 350 x 200 x 145 mm (13 3/4" x 7 3/4" x 5 3/4"). Sturdy polyethylene bins with label holders. Compatible with most louvre systems.

Part No.	Qty	Colour
SB3BU	6	Blue
SB3RE	6	Red
SB3DIV	10	Dividers

SSI SCHAEFER Storage Bins - LF341 (14/7-3ZD)

External Dimensions (D x W x H): 350 x 470 x 145 mm (13 3/4" x 17 3/4" x 5 3/4"). Sturdy polyethylene bins with label holders. Compatible with most louvre systems.

Part No.	Pack of	Colour
SB7BU	10	Blue
SB7RE	10	Red
SB7DIV	10	Dividers

SSI SCHAEFER Storage Bins - LF532

Dimensions (D x W x H): 500 x 300 x 200 mm (19 3/4" x 11 3/4" x 7 3/4"). Sturdy polyethylene bins with label holders. This bin size does NOT fit louvred panels for safety reasons.

Part No.	Pack of	Colour
SB8BU	10	Blue
SB8RE	10	Red
SB8DIV	10	Dividers

Looking for Bin Layout Ideas?

Overleaf are SSI SCHAEFER Louvred Panel + Storage Bin example layout ideas

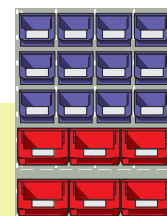



Storage Bins



SB4 Panel + SB1RE Storage Bins



SB4 Panel + SB7RE Storage Bins

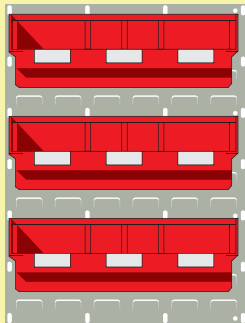

SB5 Panel + SB1RE + SB2BU + SB3BU + SB7RE Storage Bins

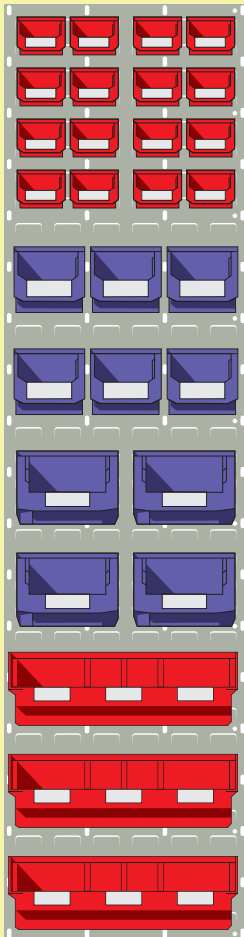

SB13 Panel + SB2BU Storage Bins

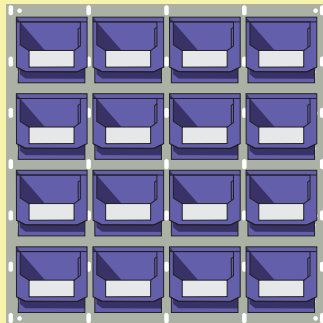

SB14 Panel + SB2BU + SB3RE Storage Bins



SB4 Panel + SB3BU Storage Bins

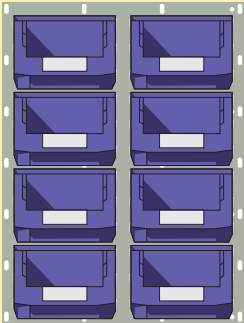

SB15 Panel + SB3BU Storage Bins

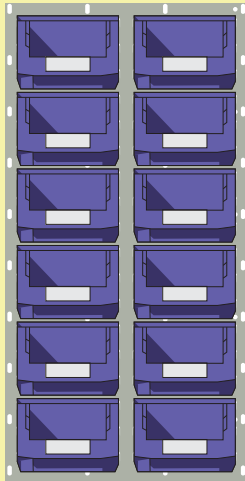

SB4 Panel + SB1BU Storage Bins

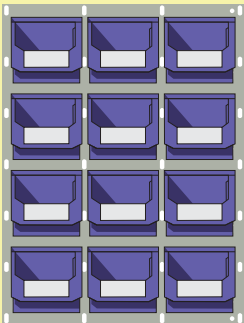

SSI SCHAEFER

SSI SCHAEFER Example Bin Layouts

Louvred Panels and Storage Bin illustrations are for guidance purposes only

Clarke

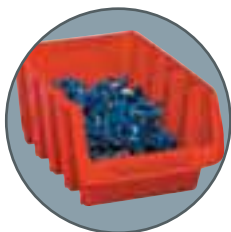

CLARKE Mobile Double Sided Storage System

Steel rack is mounted on 4 heavy duty castors (2 lockable). Supplied with 94 removable storage bins.

Part No.	Qty	Overall Dimensions (W x D x H)
SB94	1 Kit	940 x 500 x 1.245 mm





AB 'Max Box'

Large size transparent polypropylene compartment box. Dimensions (W x H x D): 333 x 58 x 228 mm (13 1/8" x 2 5/16" x 9").

- High strength, oil-resistant transparent polypropylene.
- Reinforced hinges and two snap latches give secure closure and prevent parts moving between compartments.
- Can be stacked or stored in Carrying Case (Part No. SB101).
- Available in 6 configurations.



Part No.	Qty	Compartments
SB112	1	12 Fixed



Part No.	Qty	Compartments
SB116	1	16 Fixed



Part No.	Qty	Compartments
SB118	1	18 Fixed



AB 'Max Box' Carrying Case

Made from cold rolled steel, finished in grey baked enamel.

- Holds up to 5 boxes (NOT included).
- Keyhole slots enable case to be wall-mounted.
- Bolt holes enable cases to be stacked.

Part No.	Qty	Description
SB101	1	Carrying Case



Part No.	Qty	Compartments
SB124	1	24 Fixed



Part No.	Qty	Compartments
SB106	1	6 Fixed



Part No.	Qty	Compartments
SB100	1	24 Adjustable c/w 20 Dividers



AB 'Max Box' Carrying Case Locking Hinge

Holds boxes in place whilst being transported. Can be locked with a padlock (NOT included). (Boxes NOT included).

Part No.	Qty	Description
SB102	1	Locking Hinge



BEST SELLER

AB 'Flip Box'

Standard size transparent polypropylene box. Complete with 8 dividers. Dimensions (W x H x D): 214 x 43 x 138 mm (8 3/8" x 1 3/4" x 5 3/8").

- Hinged lid overlaps on all sides of the box tray.
- 2 x Snap latches for secure closing.
- 8 x Removable dividers provide up to 10 compartments in various configurations.
- Boxes can be stacked or stored in a Storage Rack (Part No. ABR).

Part No.	Qty	Description
ABM	1	AB Flip Box

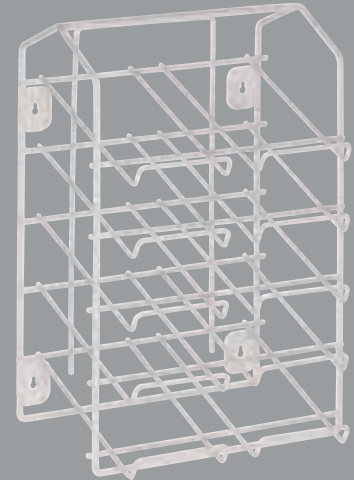

Storage Rack for AB 'Flip Box'

PVC coated wire. Dimensions (H x W x D): 460 x 300 x 210 mm. (Boxes shown NOT included).

- Holds up to 10 boxes for fast and easy retrieval.
- Can be free-standing or wall mounted.

Part No.	Qty	Description
ABR	1	Storage Rack





BARTON Steel Kick Step

Steel Kick Step is a premium GS approved quality mobile step which provides easy step up access preventing excessive stretching.

- Mounted on retractable spring mounted castors Kick Step can easily be moved into position without bending or lifting and when stepped on Kick Step locks into position allowing safe access.
- Sturdy steel construction with anti-slip rubber treads and base surround provides a solid platform from which to work.

Part No.	Qty	Dimensions (H x W x D)	Colour	Safe Working Load
SB142	1	400 x 260 x 430 mm	Blue	150 Kg



BARTON Step Ladders - 3 Tread

Folding step ladders with a platform height of 710 mm.

- Foldable for easier storage
- Distance between Treads: 230mm
- Fitted with a rubber comfort handle
- Non slip treads
- Powder coated silver/grey
- Safe Working load: 150kg

Part No.	Qty	Open (H x W x D)	Folded (H x W x D)
SB143	1	1065 x 490 x 665 mm	1220 x 140 x 490 mm



BARTON Telescopic Aluminium Sack Truck

A truck designed to transport small goods/parcels in almost any environment.

- Folds completely flat when not in use
- Telescopic handle
- Folding footplate
- Fitted with rubber cushion wheels

Part No.	Qty	Open (H x W x D)	Folded (H x W x D)	Capacity
SB141	1	1105 x 400 x 410 mm	740 x 400 x 180 mm	90 Kg



BARTON Flatbed Trolley

A sturdy, highly manoeuvrable steel trolley suitable for transporting various goods.

- Powder coated steel handles
- Folds flat for compact storage
- Fitted with non-slip rubber platforms and scuff resistant corners
- Fitted with non-marking wheels (two fixed, two swivel)

* Please allow 5-7 days delivery on this product

Part No.	Qty	Extended (H x W x D)	Folded Height	Capacity
SB140 *	1	810 x 470 x 730 mm	230 mm	150 Kg



Polythene Bags

Made from LDPE plastic which can be fully recycled.

Part No.	Qty	Size	Gauge
BAG1	1000	2 1/4" x 4"	250g
BAG2	1000	4" x 6"	250g
BAG8	1000	12" x 18"	250g
BAG3	1000	4" x 6"	500g
BAG4	1000	5" x 7"	500g
BAG5	1000	6" x 8"	500g
BAG6	1000	7" x 9"	500g
BAG7	1000	8" x 12"	500g
BAG9	500	16" x 24"	500g
BAG10	500	12" x 16"	750g



Layflat Tubing

Part No.	Qty	Width x Length	Gauge
BAG13	1 Roll	3" x 150m	500g
BAG23	1 Roll	4" x 160m	500g
BAG11	1 Roll	4" x 120m	750g
BAG12	1 Roll	4" x 100m	1000g
BAG21	1 Roll	6" x 150m	500g
BAG22	1 Roll	10" x 150m	500g
BAG24	1 Roll	16" x 155m	500g

NEW



Crossweave Tape

Clear polypropylene tapereinforced with crossweave glass fibre, coated with a synthetic rubber resin adhesive.

- High tensile strength for heavy duty bundling and packaging
- Recommended for packing of pallets and for high level reinforcements

Part No.	Qty	Colour	Width x Length
TAPE52	1 Roll	Clear	50 mm x 50 m

NEW



Wide Carton Sealing Tape

Clear polypropylene. Suitable for use with dispenser Part No. TAPE10.

- Low Noise

Part No.	Box of	Colour	Width x Length
TAPE11	24 Rolls	Clear	72 mm x 132 m

NEW



Wide Carton Sealing Tape Dispenser Gun

Suitable for use with Part No. TAPE11.

Part No.	Qty	Description
TAPE10	1	75 mm Tape Gun

BEST SELLER



Carton Sealing Tape

Brown polypropylene. Suitable for use with dispenser Part No. TAPE3.

Part No.	Pack of	Colour	Width x Length
TAPE2	6 Rolls	Brown	50 mm x 60 m



Carton Sealing Tape Dispenser Gun

Suitable for use with Part No. TAPE2.

Part No.	Qty	Description
TAPE3	1	50 mm Tape Gun





'Everyday' ESSENTIALS

The 'Everyday' ESSENTIALS range consists of 120 popular products for you to choose from

The 'Everyday' ESSENTIALS stand unit, available separately, allowing you to mix and match your own display with products to suit your market

Full top up pack range is available from page 500



Easy To Re-Stock

All of the ESSENTIALS are supplied in boxes of 5 Packs. Each peg on the stand holds exactly 5 packs so you can top up your products quick and easy!



Trim Clip ESSENTIALS

The Trim Clip ESSENTIALS Counter Display comes with a header card featuring actual size trim Clip images. The header card makes it quick and easy to choose the right trim clips and also aids in replenishing stock, doubling up as a planogram for the stand too

Top up packs are available on pages 498 and 499



Trim Clip ESSENTIALS Counter Display Starter Kit

Dimensions: W: 32 cm x H: 63 cm.
Counter display rotating carousel stand.
Complete with starter stock of 108
Trim Clip ESSENTIALS refill packs (3 of each pack).

Part No.	Qty	Description
YKITZ	1 Kit	Counter Display Kit

'Everyday' ESSENTIALS Stand

Stand dimensions (W x H): 70 x 175 cm.
Free-standing or wall mountable stand.
Complete with header card. (Supplied **WITHOUT** stock).

- 48 individual pegs hold over 240 ESSENTIALS packs (5 per peg)

Part No.	Qty	Description
YSTAND1	1	Empty Stand Only

Trim Clip ESSENTIALS

The Trim Clip ESSENTIALS range of top up packs are listed on pages 498 and 499





496



498



498



498



499



ESSENTIALS

- 496 ESSENTIALS Stands
- 498 Trim Clip ESSENTIALS
- 500 Electrical Assembly
- 502 Threaded Fasteners
- 503 Hardware
- 503 Fixings
- 504 Hose Clips
- 504 Auto
- 504 Drills



500



501



496



500



501

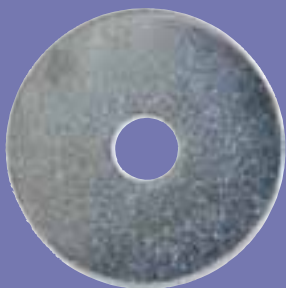

502



503



504



504



504



Trim Clip ESSENTIALS



Fir-Tree Fixings



Black. Suits CITROËN/
CHRYSLER/FORD/GM/
PEUGEOT.

Part No.	Qty
YFIX500	5 x 8



Black. Suits PEUGEOT.

Part No.	Qty
YFIX501	5 x 8



Black. Suits HONDA/
SUZUKI.

Part No.	Qty
YFIX502	5 x 8



Black. Suits BMW/
CHRYSLER/FORD/GM.

Part No.	Qty
YFIX503	5 x 8



Black.

Part No.	Qty
YFIX504	5 x 8



Black.

Part No.	Qty
YFIX505	5 x 8

Drive Rivets



Black. Suits AUDI/BMW/
CITROËN/PEUGEOT/
RENAULT/VW.

Part No.	Qty
YFIX515	5 x 8



Black. Suits AUDI/BMW/
DAEWOO/FORD/GM/
MERCEDES/VOLVO/BMW.

Part No.	Qty
YFIX517	5 x 8



Black. Suits VOLVO.

Part No.	Qty
YFIX516	5 x 8

Push Rivets



Black. Suits
MITSUBISHI/
TOYOTA/SUZUKI/GM/
Universal.

Part No.	Qty
YFIX510	5 x 8



Black. Suits CHRYSLER/
HONDA/MITSUBISHI/
TOYOTA.

Part No.	Qty
YFIX512	5 x 8



Black. Suits TOYOTA.

Part No.	Qty
YFIX511	5 x 8



Black. Suits BMW.

Part No.	Qty
YFIX513	5 x 8



Black. Suits GM.

Part No.	Qty
YFIX514	5 x 8



Black. Suits BMW.

Part No.	Qty
YFIX506	5 x 8



Black Suits MAZDA/
NISSAN.

Part No.	Qty
YFIX507	5 x 8



Black. Suits CITROËN/
FIAT/PEUGEOT/
RENAULT.

Part No.	Qty
YFIX508	5 x 8



Black. Suits HONDA/
TOYOTA.

Part No.	Qty
YFIX509	5 x 8



Trim Clip ESSENTIALS



Screw Rivets



Black. Suits FORD GM/
HONDA/MAZDA.

Part No.	Qty
YFIX522	5 x 8



Black. Suits FORD.

Part No.	Qty
YFIX518	5 x 8



Black. Suits HONDA.

Part No.	Qty
YFIX519	5 x 8



Black. Suits FORD/
HYUNDAI/KIA/MAZDA.

Part No.	Qty
YFIX520	5 x 8



Black. Suits FORD/KIA/
MAZDA/NISSAN.

Part No.	Qty
YFIX523	5 x 8



Black. Suits HONDA/
LAND ROVER/
MAZDA/ MINI/NISSAN/
SSANGYONG/TOYOTA.

Part No.	Qty
YFIX521	5 x 8

Locking Nuts



Natural. Universal

Part No.	Qty
YFIX524	5 x 8



Natural. Suits TOYOTA.

Part No.	Qty
YFIX525	5 x 8



Black.
Suits LEXUS/TOYOTA.

Part No.	Qty
YFIX526	5 x 8

1:1 Actual Size
Images

Panel Clips



Natural. Suits GM.

Part No.	Qty
YFIX527	5 x 8



Natural.
Suits CITROËN/
PEUGEOT.

Part No.	Qty
YFIX529	5 x 8



White. Suits BMW/
FORD.

Part No.	Qty
YFIX528	5 x 8



Natural. Suits GM/
HONDA/MAZDA/
MITSUBISHI/
SUBARU/SUZUKI/
TOYOTA.

Part No.	Qty
YFIX531	5 x 8



White. Suits HYUNDAI/
SUZUKI/TOYOTA.

Part No.	Qty
YFIX530	5 x 8



Grey. Suits GM/
NISSAN/RENAULT.

Part No.	Qty
YFIX533	5 x 8



White. Suits PEUGEOT.

Part No.	Qty
YFIX532	5 x 8



White/Black Surround.
Suits CITROËN/FIAT/
PEUGEOT.

Part No.	Qty
YFIX534	5 x 8



White/Black Washer.
Suits HYUNDAI/KIA.

Part No.	Qty
YFIX535	5 x 8





Electrical Assembly 'Everyday' ESSENTIALS



Red Insulated Push-on Females

Part No.	Qty
YET9	5 x 25
Width	6.3 mm



Red Push-on Males

Part No.	Qty
YET36	5 x 25
Width	6.3 mm



Red Bullets

Part No.	Qty
YET15	5 x 25
Ø	4.0 mm



Red Receptacle Sockets

Part No.	Qty
YET18	5 x 25
Ø	4.0 mm



BEST SELLER

Red Butt Connectors

Part No.	Qty
YET33	5 x 25
O.D.	3.3 mm



Red Rings

Part No.	Qty
YET22	5 x 10
Ø	5.3 mm



Red Rings

Part No.	Qty
YET25	5 x 10
Ø	6.4 mm



Red Rings

Part No.	Qty
YET28	5 x 10
Ø	8.4 mm



Blue Push-on Females

Part No.	Qty
YET7	5 x 25
Width	6.3 mm



BEST SELLER

Blue Insulated Push-on Females

Part No.	Qty
YET10	5 x 25
Size	6.3 mm



BEST SELLER

Blue Push-on Males

Part No.	Qty
YET37	5 x 25
Ø	6.3 mm



Blue Bullets

Part No.	Qty
YET16	5 x 25
Ø	5.0 mm



Blue Receptacle Sockets

Part No.	Qty
YET19	5 x 25
Ø	5.0 mm



BEST SELLER

Blue Butt Connectors

Part No.	Qty
YET34	5 x 25
O.D.	4.0 mm



Blue Rings

Part No.	Qty
YET23	5 x 10
Size	5.3 mm



Blue Rings

Part No.	Qty
YET26	5 x 10
Size	6.4 mm



BEST SELLER

Red Heat Shrink Butt Connectors

Part No.	Qty
YET91	5 x 5
Ø	3.7 mm



BEST SELLER

Blue Heat Shrink Butt Connectors

Part No.	Qty
YET92	5 x 5
Ø	5.0 mm



Blue Rings

Part No.	Qty
YET29	5 x 10
Size	8.4 mm



Yellow Rings

Part No.	Qty
YET27	5 x 10
Ø	6.4 mm



Yellow Rings

Part No.	Qty
YET30	5 x 10
Ø	8.4 mm



Yellow Heat Shrink Butt Connectors

Part No.	Qty
YET93	5 x 5
Ø	6.5 mm



Copper Tube Terminals (Cable Lugs)

Part No.	Qty
YET72	5 x 2
Ø x Hole	25 mm² x 8 mm



Copper Tube Terminals (Cable Lugs)

Part No.	Qty
YET73	5 x 2
Ø x Hole	35 mm² x 8 mm



Copper Tube Terminals (Cable Lugs)

Part No.	Qty
YET74	5 x 2
Ø x Hole	35 mm² x 10 mm



Threaded Fasteners 'Everyday' ESSENTIALS



BEST SELLER

Part No.	Qty
YHSN22	5 x 20
Size	M6



BEST SELLER

Part No.	Qty
YHSN24	5 x 20
Size	M8



BEST SELLER

Part No.	Qty
YHSN25	5 x 10
Size	M10



Part No.	Qty
YHSN56	5 x 20
Size	M6



Part No.	Qty
YHSN58	5 x 20
Size	M8



Part No.	Qty
YHSN60	5 x 10
Size	M10



BEST SELLER

Part No.	Qty
YHNN21	5 x 20
Size	M6



BEST SELLER

Part No.	Qty
YHNN22	5 x 20
Size	M8



BEST SELLER

Part No.	Qty
YHNN23	5 x 10
Size	M10



BEST SELLER

Part No.	Qty
YHFW13	5 x 20
I.D. x O.D.	M6 x 12



BEST SELLER

Part No.	Qty
YHFW14	5 x 20
I.D. x O.D.	M8 x 17



BEST SELLER

Part No.	Qty
YHFW15	5 x 10
I.D. x O.D.	M10 x 21



BEST SELLER

Part No.	Qty
YHRW2	5 x 20
I.D. x O.D.	1/4" x 1"



BEST SELLER

Part No.	Qty
YHRW3	5 x 20
I.D. x O.D.	5/16" x 1"



BEST SELLER

Part No.	Qty
YHRW15	5 x 20
I.D. x O.D.	3/8" x 1 1/4"



BEST SELLER

Part No.	Qty
YHSS44	5 x 20
Size x Length	M6 x 25



BEST SELLER

Part No.	Qty
YHSS46	5 x 10
Size x Length	M6 x 50



BEST SELLER

Part No.	Qty
YHSS50	5 x 10
Size x Length	M8 x 25



BEST SELLER

Part No.	Qty
YHSS52	5 x 10
Size x Length	M8 x 50



BEST SELLER

Part No.	Qty
YHSS53	5 x 10
Size x Length	M10 x 25



BEST SELLER

Part No.	Qty
YHSS55	5 x 5
Size x Length	M10 x 50



Large Flange Multi-grip Rivets

Part No.	Qty
YPR107	5 x 10
Ø x Length	4.8 x 19 mm



Standard Flange Black Rivets

Part No.	Qty
YPRB11	5 x 20
Ø x Length	3.2 x 8 mm

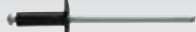

Large Flange Black Rivets

Part No.	Qty
YPRB21	5 x 10
Ø x Length	3.2 x 10 mm



Hardware + Fixings 'Everyday' ESSENTIALS



Sheet Metal Screws with Captive Washer

Part No.	Qty
YAS23	5 x 10
Gauge x Length	10 x 3/4"



Sheet Metal Screws with Captive Washer

Part No.	Qty
YAS33	5 x 10
Gauge x Length	12 x 3/4"



Sheet Metal Screws with Captive Washer

Part No.	Qty
YAS4	5 x 10
Gauge x Length	14 x 3/4"



Self-Tapping Screws Flanged Head Pozi Black

Part No.	Qty
YHTK6/4	5 x 50
Gauge x Length	6 x 1/2"



Self-Tapping Screws Flanged Head Pozi Black

Part No.	Qty
YHTK8/6	5 x 50
Gauge x Length	8 x 3/4"



Self-Tapping Screws Flanged Head Pozi Black

Part No.	Qty
YHTK10/4	5 x 50
Gauge x Length	10 x 1/2"



Self-Tapping Screws Flanged Head Pozi Black

Part No.	Qty
YHTK10/6	5 x 50
Gauge x Length	10 x 3/4"



U-Nuts

Part No.	Qty
YHUC3	5 x 10
Screw Ø	No. 10 (4.8 mm)



U-Nuts

Part No.	Qty
YHUC5	5 x 10
Screw Ø	No. 14 (6.3 mm)



No. Plate Fasteners

Part No.	Qty
YNP19	5 x 20
Colour	Blue



No. Plate Fasteners

Part No.	Qty
YNP3	5 x 20
Colour	White



No. Plate Fasteners

Part No.	Qty
YNP4	5 x 20
Colour	Yellow



No. Plate Fasteners

Part No.	Qty
YNP6	5 x 20
Colour	Black



Mixed No. Plate Fasteners

Part No.	Qty
YNP1	5 x 8
Colours	White, Yellow, Black, Blue



Security No. Plate Fasteners

Part No.	Qty
YNP33	5 x 20
Colour	White



Security No. Plate Fasteners

Part No.	Qty
YNP34	5 x 20
Colour	Yellow



Security No. Plate Fasteners

Part No.	Qty
YNP35	5 x 20
Colour	Black



Mixed Security No. Plate Fasteners

Part No.	Qty
YNP2	5 x 8
Colours	White, Yellow, Black, Blue



Trim Buttons - Fir-Tree

Part No.	Qty
YFIX20	5 x 10
Ø x H	16 x 15 mm



Trim Buttons - Fir-Tree

Part No.	Qty
YFIX29	5 x 10
Ø x H	18 x 28 mm



Trim Buttons - Fir-Tree

Part No.	Qty
YFIX21	5 x 10
Ø x H	24 x 18 mm



Drive Rivets

Part No.	Qty
YFIX39	5 x 5
Ø x S	16 x 13 mm



Screw-Type Rivets

Part No.	Qty
YFIX31	5 x 5
Ø x S	15 x 13 mm





Hardware,
Hose Clips + Automotive
'Everyday' ESSENTIALS



JCS 'Hi-Grip'
Hose Clips

Part No.	Qty
YJCSM00	5 x 3
Range	11 - 16 mm



JCS 'Hi-Grip'
Hose Clips

Part No.	Qty
YJCS0	5 x 3
Range	14 - 22 mm



JCS 'Hi-Grip'
Hose Clips

Part No.	Qty
YJCS0X	5 x 2
Range	17 - 25 mm



Split Pins - Imperial

Part No.	Qty
YHSP8	5 x 10
O.D. x Length	5/32" x 2"



Split Pins - Imperial

Part No.	Qty
YHSP9	5 x 10
O.D. x Length	3/16" x 2"



Linch Pins with
O-Ring

Part No.	Qty
YLP1	5 x 2
Pin Size	1/4" x 1 3/4"



Brake Pad Pin
Retainers

Part No.	Qty
YBR6	5 x 10
Size	Small



Brake Pad Pin
Retainers

Part No.	Qty
YBR7	5 x 10
Size	Large



Mini Hose Clips

Part No.	Qty
YHCA11	5 x 5
Ø Range	10 - 12 mm



Mini Hose Clips

Part No.	Qty
YHCA12	5 x 5
Ø Range	11 - 13 mm



Mini Hose Clips

Part No.	Qty
YHCA13	5 x 5
Ø Range	12 - 14 mm



Short Metric Male
Brake Nuts

Part No.	Qty
YBN11	5 x 4
Ø x Pitch	M10 x 1.00 mm



Full Thread Metric
Male Brake Nuts

Part No.	Qty
YBN13	5 x 4
Ø x Pitch	M10 x 1.00 mm



Short Metric Female
Brake Nuts

Part No.	Qty
YBN46	5 x 4
Ø x Pitch	M10 x 1.00 mm



Cutting + Drilling
'Everyday' ESSENTIALS



Tyre Valve Caps
Plastic

Part No.	Qty
YTV120	5 x 10
Type	Plastic



Standard Trim Knife
Blades

Part No.	Qty
YTL662	5 x 10
Description	Knife Blades



ALPEN 'Sprint' HSS
Jobber Twist Drills -
Imperial

Part No.	Qty
YDR18	5 x 2
Ø	1/8"



ALPEN 'Sprint' HSS
Jobber Twist Drills -
Imperial

Part No.	Qty
YDR316	5 x 1
Ø	3/16"



ALPEN 'Sprint' HSS
Jobber Twist Drills
- Metric

Part No.	Qty
YDRM3.3	5 x 2
Ø	3.3 mm



ALPEN 'Sprint' HSS
Jobber Twist Drills
- Metric

Part No.	Qty
YDRM4	5 x 2
Ø	4.0 mm



ALPEN 'Sprint' HSS
Jobber Twist Drills
- Metric

Part No.	Qty
YDRM5	5 x 2
Ø	5.0 mm



ALPEN 'Sprint' HSS
Jobber Twist Drills
- Metric

Part No.	Qty
YDRM6	5 x 1
Ø	6.0 mm



1	
1/4" Drive Ratchet + Socket Sets	458
1/4" Drive Sockets	458, 460-463
1/2" Drive Impact Sockets	464-466, 469
1/2" Drive Ratchet & Socket Sets	459
1/2" Drive Sockets	459, 461-466, 469
1" Drive Impact Sockets	465
110V Cable Reel	65
110V Plugs & Couplers	65
150% Performance Autobulbs	90-93
1K Epoxy Primer (Aerosol)	313

2	
240V Plugs & Couplers	66
2K Polyurethane Repair Adhesives	329

3	
3/8" Drive Impact Sockets	466
3/8" Drive Ratchet + Socket Sets	458, 459
3/8" Drive Sockets	458-463
3/4" Drive Impact Sockets	465



3M Masking Tapes	320
3M Scotchlocks	35
3-Pin Plugs & Couplers	65
3-Pin Plugs (Mains)	64

4	
400V Plugs & Couplers	66



4-Jaw Hydraulic Connectors	302
4-Pin Plugs & Couplers	66

5	
5-Pin Plugs & Couplers	66

7	
7-Pin Trailer Sockets & Plugs	262

A	
AB 'Flip Box' (Empty)	26, 493
AB 'Max Box' (Empty)	26, 493
Abrasive Discs	404-411
Abrasive Pads	399
Absorbent Floor Granules	360, 361
Absorbent Pads	360, 361
Absorbent Rolls	360, 361
Absorbent Socks	360, 361
AC/DC Voltage Tester	482
Accelerator & Clutch Springs	21, 149, 258
ACCURA Digital Inflator	231



Acme Screws	14, 145-147, 503
-------------	------------------



Acrylic Paint Marker Pens	315, 398
---------------------------	----------

Activator (Super Glue)	325
ACURA Trim Clips	191-192



AdBlue Delivery Hose	289
AdBlue Nozzle	289
AdBlue Solution	298
AdBlue Solution Barrel Pumps	300, 356
'Add A Circuit'	47
Additives	288
Adhesion Promoter (Primer)	312
Adhesive Dressings (Plasters)	362
Adhesive Lined Heat Shrink Terminals	23, 32, 500

Adhesive Lined Heat Shrink Tubing	38
Adhesive Pads	141, 321
Adhesive Spray	325
Adhesive Tapes	39, 320-323, 360, 361, 495
Adhesive Wheel Weights	247
Adhesives Kit	325
Adjustable Wrenches	453
ADVANCE Tapes	39, 321, 323
Advance/Retard Tubing	215
Aerosol Assortment Packs	304, 299, 310, 315, 318

After-Work Conditioner Cream	318, 343
Air Brake Hose	215
Air Compressor Unit (Professional)	229
Air Compressors	234-235
Air Con/Refrigerant UV Dye	299
Air Conditioning O-Rings Kit	11, 135
Air Conditioning Sanitiser	291
Air Duster (Aerosol)	291
Air Freshener (Odour Eliminator)	295, 296
Air Fresheners	296
Air Gun (Paint Drying)	228
Air Gun Vacuum/Blower Kit	229
Air Hose	217
Air Line Assemblies	217
Air Line Coil	217
Air Line Connectors	220-224
Air Line Couplings & Adaptors	220-224
Air Line Fittings	220-224
Air Line Gauges	232-233
Air Line Hose	217
Air Line Tubing	217
Air Operated Grease Gun	226
Air Regulator/Gauge	228
Air Saw Blades	427
Air Side Oiler	224



Air Tool Oil	226
Air Tool Whip Hose	226
Air Tools	226-227

Air Water Trap	224
'Airflow' Couplings	220
Alarm Remote Batteries	112, 501
ALFA ROMEO Trim Clips	190
Alkaline Batteries	108, 109, 111
'All Plastics' Super Glue Kit (LOCTITE)	324
All Purpose Cleaner	300
'Allen' Keys (Hex Keys)	414-451
ALLIGATOR Valve Caps	243
Alloy Wheel Impact Sockets	469



ALPEN Drills	413, 418-421, 504
ALPEN 'Sprint'	418, 504
ALPEN 'Super'	419
ALTA Sprayers	357, 358
Alu Zinc Galv Spray	312
Aluminium Foil Tape	321
Aluminium Putty	327
Aluminium Washers	10, 133, 137



Amber Beacons	78-79, 280-281
Amber Lightbars	281
Amber Warning Lights	277



AMBERSIL	308, 312, 315, 398
AMBERSIL Marker Pens	315, 398
Angle Iron	150
Anti Corrosion Graphene Primer	313
Antibacterial Hand Soap	339
Anti-Corrosion Tape	321
Anti-Freeze Testers	482
Anti-Glare Visor	355
Antiluce Fasteners	271
Anti-Scuff Paste	304
Anti-Seize Compound	304, 305
Anti-Seize Copper	304, 305
Anti-Slip Hazard Tape	322
Anti-Spatter Spray	393
Anti-Vibration Gel Gloves	374, 469
Antiviral Disinfectant	347
ARALDITE Rapid	328



ARCTIC HAYES	328, 398
Assortment Box Rack	26, 493
ATOF Blade Fuse Holders	47
ATOF Blade Fuses	24, 25, 46
AUDI Trim Clips	185-187
Auto Bulb Kits	102
Auto Bulbs	82-103



Auto Bulbs (NEOLUX)	82-85
---------------------	-------

Auto Bulbs (Performance Upgrade)	90-93
Auto Bulbs (RING)	82-103
Auto Cable	61-63
Auto Fuses	24-25, 46-51, 501
Auto Lamps	82-103
Auto Silicone Sealant	334
Autobulbs (AUTOLAMPS)	88-89
Autobulbs (EUROLEC)	86-89
AUTOLAMPS Autobulbs	88-89
Automatic Wire Strippers	58
Automotive Oils & Fuels UV Dye	299
Automotive Tester (Multi-Function)	482
AUTOSOL Metal Polish	299



AVDEL Rivets	15, 151, 153
Axle Stands	248, 470

B	
Backing Pads	404, 405
Backing Panels (Storage Bins)	490, 491
Bactericide Spray	347
Badge Tape (Transparent)	320
Bags (Packing Polythene)	495
Bags (Vacuum)	351, 353
Bags of Rags	348



BAHCO	412, 425-428, 430, 434, 453, 480
BAHCO Blades (Powersaw)	426
BAHCO File Sets	412
BAHCO Hacksaw Blades	425, 426
BAHCO Hacksaw Frames	425, 426
BAHCO Handsaw	427
BAHCO Jigsaw Blades	427
BAHCO Junior Hacksaw	426
BAHCO Knife	428
Ball Joint Covers	21, 251
Ball Joint Dust Covers - Rubber	251
Ball Pein Hammers	438, 439
Ball Point Hex Keys	414-451
Banding System (Hose Clip)	205
Bar (Metal)	150
Barrel Olives	19, 206
Barrel Pumps	300, 303, 356
Barrel Taps	355
Barrier Creams	318
Barrier Tape	336
BARS Radiator Stop Leak	288
Batteries	108-112, 501



Batteries (Alkaline)	108, 109, 111
Batteries (Button Cells + Coins)	112, 501
Batteries (DURACELL)	108, 111
Batteries (Lantern)	112
Batteries (Rechargeable)	110-111
Battery Analyser	106
Battery Chargers	105
Battery Clamp Puller	479
Battery Isolator Switches	45
Battery Retaining Brackets	41





Battery Terminal Cleaning Tool	41
Battery Terminal Covers	40
Battery Terminal Protector	41
Battery Terminals	40
Battery/Starter Cable	63
Beacons (Amber)	78-79, 280-281
BEAD BAZOOKA (Bead Sealer)	245
Bead Beakers (Tools)	244-245
Bead Breaker (Hydraulic)	245
Bead Lubricant (Tyre Soap)	241
Bead Paste	241
Bead Sealer	241
Bead Sealer (Bead Bazooka)	245
Beaded Type Hand Gel	339, 341, 342
Beam Blades (Wiper)	268
Bearing Fit Universal Retainer	327
Bench Grinding Wheels	399



BIBIELLE Abrasives	403, 405, 406, 408-411
BIBIELLE Cutting Discs	408-410
BIBIELLE Grinding Discs	411



BIG WIPES Industrial Wipes	344
Bin Bags	348
Bins (Rubbish)	348
Bins, Storage	488-493
Bit Holders	446, 447
Bits (Hex)	446, 447
Bits Sets	446, 447
Bits Tray	488
Black Paint	314
'Black Pearl' Nitrile Gloves	374
Blacksmiths' Drills	421
Blade Fuse Extractor & Tester	47
Blade Fuse Holders	47-49, 501



Blade Fuses	24-25, 46-49, 501
Blade Fuses (LED)	25, 46
Blade Fuses (LITTELFUSE)	24, 25, 46-51
Blades (Hacksaw)	425, 426
Blades (Jig Saw)	427
Blades (Trimming Knives)	428-430, 504
Blades (Wiper)	268-269
Blanking Grommets	24, 37
Bleed Screws	256-257
Blind Rivets	151-153
Blister Packs (Essentials)	496-504



Blow Guns	225-228
Blow Pistol	225
Blower/Vacuum Kit	229
Blue Hose Connectors	205
Blue Hylomar 'Universal Blue'	332
Blue Instant Gasket	333

Blue Nitrile Gloves	374
Blue Paper	347
BMW Clips	187-188
Boards (Maker)	275
Bobbins (Exhaust)	267
Body Clips	15, 161-200
Body Fixings	15, 161-200, 496, 498-499, 504
Body Screws	124, 146-147
Body Trim Rivets	151, 184
Bodywarmers	384
Bolt Cutters	430
Bolts & Nuts (Number Plate)	140
Bolts (Coach)	118



Bolts (High Tensile)	117
Bonded Seals	11, 135, 137



BONDHUS	414-451
Bonding Adhesives	324-325, 328
Bonnet Buffers	181
Bonnet Cables	270
Booster Cables (Jump Leads)	106
Boot Lace Terminal Pliers	59
Boots (Safety)	386-387
Bottle Jacks	249, 471
Bowden Cable	270
Boxed Hose Clips	204
Boxer Heater Spares	397
Boxes ('AB' Storage)	26, 493
BRADEX Easy Start	308
Brake & Air Line Thread Sealants	335
Brake & Clutch Fluid	289
Brake Bleed Screws	256-257
Brake Bleeding Flare Nut Spanners	475
Brake Caliper Piston Tool	475



Brake Cleaner	300
Brake Cylinder Hones	472
Brake Fluid Tester	482
Brake Hardware	20, 252-257, 504



Brake Nuts	20, 252-255, 504
Brake Pad Pin Retainers	257, 504
Brake Pad Springs	257
Brake Pad Washers	257
Brake Pipe	216
Brake Pipe Flaring Tools	440-475
Brake Piston Wind Back Kit	475
Brake Servo Hose	215
Brake Shoe Hold-Down Kit	20, 257
Brake Tools	473-475

Brake Tubing	216, 255
Brake Tubing Connectors	20, 254-255
Brakes	244-257
Brass Claw Fittings	213
Brass Drifts	440
Brass Hose Connectors	205, 213
Brass Nuts	129
Brass Tube Couplings	213
Brazing Flux	393
Brazing Rods	391
Breakaway Cable	274
Breaker Hose Sets	216, 284
Breaker Hose Tails	216, 284
Breaker Pig Tails	216, 284
BRENNENSTUHL Electric Engraver	437
Bright Alu Zinc Galv Spray	312
Broom Handles	349, 350



Broom Heads	349
Brushes (Cleaning)	349
Brushes (Conical)	400
Brushes (Cup)	400
Brushes (Mounting)	400
Brushes (Nail)	347
Brushes (Paint)	317
Brushes (Parts Cleaning)	401, 481
Brushes (Tyre Mounting)	241
Brushes (Vacuum)	351-354
Brushes (Wash)	296
Brushes (Wheel)	400
Brushes (Wire)	400-401
Buckets	354
Buffer Kit	407
Buffing Stone	241
Bulb Kits (Auto)	101, 102
Bulb Stands	102, 103
'Bulbex' Rivets	151
Bulbs (Auto)	82-103
Bulbs (AUTOLAMPS)	88-89
Bulbs (Domestic Type)	81
Bulbs (EUROLEC)	86-89
Bulbs (Halogen Linear)	80
Bulbs (Hand Lamp)	80-81
Bulbs (Heater)	81
Bulbs (Metal-Halide)	80, 279
Bulbs (NEOLUX)	82-85
Bulbs (Panel)	101
Bulbs (RING AUTOMOTIVE)	81, 82-103
Bullets & Connectors	28-32
Bump Caps	377
Bumper & Trim Shine (Cockpit Shine)	291, 292, 294
Bungs (Diesel Leak Off)	214
Burncare Kit	363
Burrs	413



Butane Gas Chargers	395
Butane Gas Regulators	397
Butt Connectors	23, 28-33, 500
Button Cell Batteries	112, 501

Cabinet (Hazardous Substance)	489
-------------------------------	-----



Cable (Auto)	61-63
Cable (Bonnet)	270
Cable (Bowden)	270
Cable (Breakaway)	274
Cable (Diesel Stop)	270
Cable (Mains)	63
Cable Accessories	24, 52-53, 501
Cable Clips	52-53, 183
Cable Cutters	60, 430-432
Cable Glands	53
Cable Lock (Security)	485
Cable Lube (Chain & Cable Lube)	309
Cable Plugs (Welding)	393
Cable Rack	64
Cable Reels	64
Cable Slewing	53
Cable Tie Bases	52
Cable Tie Cradle Mounts	24, 52
Cable Tie Tool	58



Cable Ties	54-57, 501
Cable Ties (Coloured)	56
Cables (Booster)	106
Cables (Whip Check)	284
Cage Nuts	151
Calipers	437
Cambus (LED Resistor Kit)	98
Capacitors	42
Caps (Tyre Valve)	243, 504
Car Chargers (Battery)	105
Car Interior Protection Set	298
Car Seat Covers (Disposable)	298
Car Seat Protector	298
Car Transporter Ratchet Straps	272
Carb Cleaner (Throttle Body Cleaner)	301
Carbide Mill Cutters	242
Carbon Monoxide Alarms	363
Carpet Shampoo	294
Carrying Case (Storage Boxes)	26, 493
Carton Sealing Tapes	322, 495



Cartridge Guns	329, 333, 334, 336
Cassette Cable Reel	64
Cassette Hose Reel	216
Castors (Vacuum)	353
Caulking Guns	329, 333, 334, 336
Caution Wet Floor Sign	350, 361
C-Clamps	434
CE-LIT Radiator Cement	288
Cement (Tyre Repair)	239
Ceramic Anti-Seize Compound	305
Ceramic Flap Discs	406
Ceramic Lamp Holder	81



Ceramic Terminal Block 35
Ceramic Type Fuses (Torpedo) 24, 51

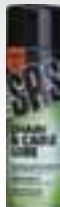

Chain & Cable Lube 309
Chain Locks 485, 486
Chain Nose Pliers 434, 435
Chains (Security) 485
Chamois Leather 297
Channel Blocks 346
Chargers (Vehicle Battery) 105
Charts - Trim Clips 161, 200
Chassis Cable Ties 57
Chassis Clips 52

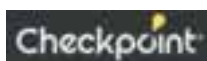

CHECKPOINT Indicators 246
Cheeseburger Tail Lamp 276
Chemical Metal 331
Chemical Sprayers 357-358
CHEMICO Grinding Paste 258, 288
Chimney Nuts 14, 149
Chipping Hammer 392
Chisels 440-441
Christmas Tree Fixings 15, 163-164, 498
CHRYSLER Trim Clips 188-189
Chuck Keys 422
Chucks (Drill) 422
Circlip Pliers 436
Circlips 17, 156
Circuit Breakers (Blade Fuses) 46
Circuit Breakers (RCD) 66-67
Circuit Breakers (Transformer) 65
Circuit Testers 482
CITROËN Trim Clips 189
Clamps 434
Clamps (Exhaust) 266
Claw Fittings (Hose) 213
Claw Hammer 439
Cleaner (All Purpose) 300, 346
Cleaning (Aerosols) 300-301
Cleaning Cloths 348
Clear Fine Oil (Aerosol) 309
Clear Glue (Impact Adhesive) 328



Clear Grease 309
Clear Instant Gasket 333
Clear Repair Tape 321
CLEARALEX Screen Wash 289
Clevis Pins 17, 157
'Clic' & 'Clic R' Type Hose Clip Pliers 206
Clips (Crocodile) 33
Clips (Jump Leads) 106
Cloths (Cleaning) 347-348

Clutch Springs 258
CO Alarm 363
CO Detectors 363
Coach Bolts 118
Coated Abrasives 402-405
Cobalt Drills 420
Cockpit Shine 291, 292, 294
Cockpit Spray 291, 292, 294
Coin Batteries 112, 501
Cold Chisels 441
Cold Galvanise (Aerosol) 312
Cold Weather Tape 321
Cold Weld 328-329
'Cold-Chek' Testers 482
Coloured Cable Ties 56
Combi Nuts 138
Combi Plug Patches 239
Combination Lock (Padlock) 485
Combination Pliers 434, 435
Combination Spanners 452-454
Comfort Masks 346
Commercial Auto Cable 61, 62
Commercial Products 271-278



COMPAC Hydraulic Trolley Jack 248, 470
Compounding Pads 407
Compression Springs 18, 159
Compressor Hose Assembly 215, 218-219, 284
Concentrated Screen Wash 269, 289
Concrete Remover 286, 306
Conditioning Creams 338, 343
Conduit Tubing 53
Conical Brushes 400
Connector Blocks (Wire) 35
Connectors (Multiple) 34-35
Connectors (Supaseal) 24, 36-37
Contact Adhesive 328
Contact Cleaner (Electrical Cleaner) 301
Containers (Storage) 489
Convolute Cable Sleeving 53
Coolant System UV Dye 299



Copper Grease 304, 305
Copper Sealing Washers 10, 132-136
Copper Tube Butt Connectors 23, 33
Copper Tube Crimping Tool 58
Copper Tube Terminals 23, 33, 500
Copper Tubing 218, 255
Copper Washers 9, 10, 132-136
Cordless LED Hand Lamps 73-76
Core Plugs 21, 259
Corrosion Assessment Hammer 271
Cotton & Chrome Gloves 376
Countersinks 421
Couplers (& Plugs) 65-66
Couplers (Mains/Transformer) 65-66



Couplings (Air Line) 220-223

Couplings (Hydraulic) 282
Couplings (Tube) 210-213
CRETEBEATER Concrete Remover 286, 306
CRI95+ LED Hand Lamps 74



Crimping Pliers 58
Crocodile Clips 33
Cross Pein Hammer 438
Crossweave Tape 322
Crow Foot Wrenches/Spanners 453
Cup Brushes 400
Cut-off Wheels 408
Cutters 430-432
Cutters + Snips 430-432



Cutting Discs 408-410
Cutting Nozzles 393
Cutting Oil Spray 309, 416
Cutting Paste (Polish) 293
Cutting Pliers 430-432
CV Boot Clamp Pliers 203, 208



CV Boot Metal Clamps 203
CV Boot Tools 250
CV Boots 250
CV Joint Grease 304
Cyanoacrylates (Super Glue) 324-325
Cylinder Hone De-Glazer 472
Cylinder Keys/Spanner 392

D
Damp Start Spray 308
Darlek (Kick Step) 494
Dash Cams 68
Dashboard Renovator (Cockpit Shine) 294
DATSUN Trim Clips 195
Dead Blow Hammer 439



DEB Hand Care 342-343
Decking Screws 142



DECOSOL 289, 290
Deep Impact Sockets 464-466
Deep Sockets 458, 459, 461, 463, 464-466
Degreaser (Surface) 346
De-icer 290



DELTA PLUS PPE Products 377-388
DEN-BRAVEN Silicone 334
Detailing Range 292-293
De-watering Sprays 307-308
Dial Type Air Line Gauge 232
Diamond Cutting Discs 411
Die Blocks for Flaring Tools 475
Die Cast Zinc Drum Tap 355
Die Grinder 226, 227
Dies 423
Diesel Fuel Filters 258
Diesel Fuel Treatment 288
Diesel Injector Cleaner 288
Diesel Injector Washers 10, 20, 135
Diesel Leak Off Bungs 216
Diesel Stop/Bonnet Cables 270
Digital Multimeter 482
Digital Slide Caliper 437
Digital Tyre Inflators 229-231
Digital Tyre Pressure Gauges 233
Digital Vernier Caliper 437
Din Pole (for Amber Beacons) 78, 79, 280, 281

Dinse Type Welding Plugs/Sockets 393
Dipping Tape Tool 285
Discs (Cutting) 408-410
Discs (Grinding) 411
Discs (Sanding) 404-405
Disinfectant 346, 347
Dispenser (Paper Towels) 347
Dispenser Guns (Tape) 322, 495
Dispenser Units (Hand Cleanser) 339, 341, 342, 343
Dispenser Units (Paper Rolls) 348
Disposable Dust Masks 346
Disposable Gloves 374
Disposable Overalls 385
DODGE Trim Clips 188-189
Domestic Mains 64, 501
Domestic Mains Cable 63
Door Hinge Pins 149



DORMER Drills 416-417, 420
Double Ring Spanners 452
'Double-Bubble' Epoxy (LOCTITE) 328
Double-Sided Adhesive Pads 141, 320
Dowty Type Washers 9, 135, 137
Drain Pans 354
Dressings (Adhesive Plasters) 362



DREUMEX Hand Gel 339
Drifts (Brass) 440
Drill Boxes 416-421
Drill Chuck Keys 422
Drill Chucks 422
Drill Dispensers 416-421



Drills 416-421, 504





Drills (ALPEN)	418-421, 504
Drills (Blacksmith)	421
Drills (DORMER)	416-417, 420
Drills (Masonry)	421
Drills (Spot Weld)	420
Drills (Step)	421
Drills (Taper)	421
Drive Adaptors	456
Drive Rivets	15, 168-169, 498
Drive Shaft Boots	250
DRONCO/OSBORN Abrasives	406-411
Drum Pump	241
Drum Taps	355
Dry Molybdenum (Aerosol)	308
Drying Towels (Valeting)	297
'Duck Oil'	308
Duct Sealing Tapes	321
Duplex Lifting Slings	273

DURACELL®

DURACELL Batteries	108, 111
'Duragun' CV Boot Fitting Tool	250
Dust Covers (Ball Joints)	21, 251
Dust Masks	346
Dust Pan (Metal)	327
Dustbin & Lid	348
Dustbin Liners	348
DUSTITE Indicators	246
Dustpan & Brush (Plastic)	349
Dye Injector (UV)	299
Dyes (UV)	299
DYNOMECH Wheel Nut Removal Kit	246

E	
Ear Defenders	383
Ear Muffs	383
Ear Plugs	382-383
Earthing Clamp	392
'Easy Start'	308



ECLIPSE	425, 426, 430
ECLIPSE Bolt Cutters	430
ECLIPSE Hacksaw Blades	425, 426
ECLIPSE Hacksaw Frames	425
ECLIPSE Powersaw Blades	426
ECLIPSE Tin Snips	430
ECLIPSE-SPIRALUX Riveters	144-145



Electrical Cleaner	301
Electrical Terminals	22-23, 28-33, 500
Electricians Miniature Side Cutters	59, 430
Electricians' Screwdrivers	444
Electrode (Gas Heater)	397
Electrode Holder	392
Electrodes (Welding)	391
ELWIS	74
Emergency Exit Signs/Stickers	367

Emergency Tyre Repair (Aerosol)	235, 242
Emery Rolls	402
Emery Sheets	402
Emery Tapes	402
Empty Boxes + Storage	26
End Brush	400
End Cutting Nippers	431
Endless Round Lifting Slings	273
Engine Flush	288
Engine Products	258-265
Engineers' File Set	412
Engineers' Hickory Shafts	438
Engraver (Electric)	437
EP Lithium Grease	304, 305



Epoxies	327-301
Epoxy Primer	313
Epoxy Putty Stick	327
Epoxy Weld	328-329
E-Retainers	17, 157

ESSENTIALS

ESSENTIALS	496-504
ESSENTIALS Stands	496
Etch Primer	313
E-TORX Compatible Socket	466
Euro Containers	489
EUROLEC Autbulbs	86-89
European Marker Boards	275
Evacuation/Dispenser Pump	473

EVEREADY®

EVEREADY Lantern Batteries	112
EVO-STIK Impact Adhesive	328
EXACT Cone Cutters/Taper Drills	421
Exhaust & Tailpipe Cutter	479
Exhaust Assembly Pastes	336
Exhaust Clamps	266
Exhaust Cutter	479
Exhaust Manifold Studs & Nuts	20, 119, 267

Exhaust Mountings	267
Exhaust Products	266-267, 336
Exhaust Repair Putty	336
Exhaust Sealants	336
Exit Signs/Stickers	367
Expanding Foam	334
Expansion Springs	18, 159
Extension Cable Reels	64
Extension Caps (Tyre Valve)	243
Extension Lead (Mains)	64
Extension Lead (Trailer Board)	274
Extensions (Impact)	465
Extensions (Socket)	456, 457
Extinguishers (Fire)	363
Extra High Temp Gasket	333
Extra High Temp Instant Gasket	333
Extreme Maintenance Lubricant	307, 308
Eyewash Station	363

F	
Face Protection	378-379, 390

Face Shield (Welders)	390
Face Shields/Visors	344
Fall Arrester Harness	388
Farmers 'Silage' Tape	323
Fast Drying Solvent (Aerosol)	301
Fasteners (Antiluce)	271
Fasteners (Nuts c/w Set Screws)	2, 115
Feeler Gauges	437
Female TORX Impact Socket	466
Ferrules (Steel Wire)	270

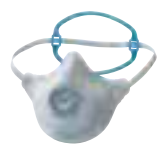

FFP Masks	380-381
FIAT Trim Clips	190
Fibre Washers	9, 133, 137
Fibreglass (MOTIP)	331
Fibreglass Putty (MOTIP)	331
File Handles	412
File Sets	412
Files	412
Files (Engineers)	412
Files (Needle)	412
Filler Spreader (Plastic)	329
Filter Wrenches	478
Filters (Vacuum)	351, 353
Fine Line Masking Tape	320
Fine Oil (Aerosol)	309
Finishing Pads	399
Finishing Putty (MOTIP)	331
Fire Exit Signs/Stickers	367
Fire Extinguishers	363
Fire Safety Signs/Stickers	366-367
Firearm (HOLTS)	336
First Aid Kits	362-363
Fir-Tree Fixings	15, 163-164, 498
Fittings (Trailer Hardware)	271
Fix Regrooving Blades	245
Fixings (Self-Drilling)	145
Flame Device (Gas Heater)	397
Flame Torches	395, 398
Flange Nuts	6, 128, 129, 502
Flanged Set Screws	116



Flap Discs	406
Flap Wheels	403
Flare Nut Crowfoot Spanners	453
Flare Nut Spanners (Brake)	475
Flaring Tools	440-475
Flat Bar	150
Flat Chisels	440, 441
Flat Clips (Push-on Fixes)	14, 150
Flat Metal Cutting Discs	408-410



Flat Washers	8, 130-131, 502
Flatbed Trolley	489
Flex Handle	456

Flex Head Ratchet	455
Flexible LED Hand Lamps	74, 75
Flexible Rubber Hoses	302, 303
Flick Switches	43-45
Flint Lighters	393
Flip-Up Goggles	390
Floor Mats (Absorbent)	360, 361
Floor Mats (Paper)	298
Floor Paints	315
Floor Squeegees	350
Floorboards Screws	142
Fluorescent Tube	80
Flux (Brazing)	393
Flux (Soldering)	394
Foam Cleaner	291
Foam Sprayers	286, 294, 306, 295, 357
Foam Tapes	320, 321
Foaming Hand Sanitiser	343
Foaming Hand Soap	339, 342
Foil Tape	321
Folding Knife	428
Folding Paper Towels	347
Food Safe Cable Ties	57
Food Safe Lube	309
Foot Protection	386-387
Foot Pump	234
FORD Trim Clips	190-191
Four-Jaw Hydraulic Connectors	302
Freeze Release Spray	308
Friction Bushes	175
'FRP' Ratchets	455



FUCHS Lubricants	226, 284, 304, 306
FUCHS Plant/Hydraulic Oils	284, 306
Fuel Cans	355
Fuel Filters	258
Fuel Hose	216
Fuel Injection Hose	216
Fuel Injector Cleaner	288
Fuel Pipe Pliers Set	209, 210
Full Face Masks	382
Fully Insulated Terminals	22-23, 28-32, 500
Funnels	359



Fuse Holders	47-49, 47, 501
Fuses	24-25, 46-51, 501
Fuses (ATOF)	24, 25, 46-49
Fuses (Blade)	24-25, 46-49, 501
Fuses (Glass)	25, 51
Fuses (JCASE)	50



Fuses (Mains)	47, 64
Fuses (MAXI Blade)	49
Fuses (MEGA)	51
Fuses (MICRO)	48
Fuses (MINI Blade)	24-25, 48-49, 501
Fuses (PAL Auto)	50
Fuses (Radio)	51
Fuses (Torpedo)	25, 51

G



Gaffer Tapes	321
Galvanise Spray	315
Gap Filling Super Glue	324
Gas Accessoires (LPG)	396-397
Gas Bottle Spanner	396
Gas Chargers	395
Gas Cutting Nozzles	393



Gas Cylinders	398
Gas Heater Spares	396-397
Gas Hose	397
Gas PTFE Tape	335
Gas Soldering Kit	395
Gas Torches	395, 398
Gas Welding Rods	391
Gas Welding Sundries	390-393
Gasket Compounds	332-334
Gasket Paper	258
Gasket Sealants	332-334
Gasket Stripper	301
Gauntlets	377, 390
G-Clamps (PYTHON)	434
Gear Lube	309
Gel Adhesive	324, 325
Gel Gloves	374, 469
Gel Knee Pads	385
General Signs/Stickers	370
GEOCEL Auto Silicone	334
Glands (Cable)	53



Glass Cleaners	290, 291, 292, 294
Glass Cleaning Cloths	297
Glass Fuse Holders	51
Glass Fuses	25, 51
Glasses (Safety)	378-379
Gloss Black Paint	313
Gloss Paint	315
Gloves	374
Gloves (Heat Tolerant)	376
Gloves (Latex)	374
Gloves (Nitrile)	374
Glue (Impact Adhesive)	328
Glue (Spray)	325
Glue (Super)	324-325
Glue Gun	328
Glue Sticks	328
GM Trim Clips (Vauxhall)	198-199



Goggles (Safety)	378-379
Goggles (Welding)	390

GP Batteries

GP BATTERIES	109-112
Graffiti Remover (Label & Gum Remover)	301
GRANVILLE Brake & Clutch Fluid	289
GRANVILLE Instant Gasket	332
GRANVILLE Rust Cure	311
GRANVILLE Rust Repair	311
Graphene Primer	313
Graphited Lubricant	309
Graphited Penetrating Oil	309
Grease	304-305, 309-310
Grease Guns	227, 303
Grease Nipples	21, 302
Grease Pump Unit	303
Grey Primer	314
GRIME-EEZ Multi Wipes	344
GRIMEX Hand Cleaning Wipes	345
Grinding Discs	411
Grinding Goggles	344
Grinding Paste	258, 288
Grinding Sticks	258, 288
Grinding Wheels	399
Grip Gloves	374-376
GRIPPAZ Gloves	374
Gripper Gloves	374, 375, 376
Grommets (Trim Fixings)	175
Grommets (Wiring & Blanking)	24, 37
Groove Joint Pliers	436
Ground Flute Drills	419
Grub Screws	4
Gum Remover	301
Gun (CV Boot)	250
Gun Gum (HOLTS)	336
Guns (Spray)	228
Guns (Tape)	323, 495

H

H07 Mains Cable	61
Hacksaw Blades	425, 426



Hacksaw Frames	425, 426
Half Mask	381-382
Half Nuts	128
Halogen Auto Bulbs	82-83, 86-87, 90-93, 102
Halogen Bulbs (EUROLEC)	86-87
Halogen Bulbs (Linear)	80
Halogen Bulbs (NEOLUX)	82-83
Halogen Bulbs (RING)	90-93, 102
Hammer Shafts	438
Hammers	438-439
Hand Brushes	349
Hand Care	340-344
Hand Cleaner Towels	344, 347
Hand Cleaning Wipes	344-345
Hand Cleansers	340-343
Hand Gel	339-343
Hand Lamp Bulbs	80, 81



Hand Lamps	73-76
Hand Pump	303
Hand Pump (Oil Suction)	356
Hand Rasp (Tyre)	240
Hand Sanitiser	338, 343
Hand Taps	423
Hand Towels (Paper)	347



Hand Wipes	344-345
Handsaw	427
Handy Wipes	344-345
Hanging Rods	490
Hard Hats	377
Hasp & Staple	486-487
Hasps	486-487
Hazard Warning Adhesive Tapes	322, 360, 361

Hazard Warning Barrier Tape	336
Hazard Warning Signs/Stickers	368-371
Hazardous Substance Cabinets	489
Head Torches	70-71
Headlight Adjuster Kit	477



Headlight Auto Bulbs	82-83, 92-94
Headlights (Torches)	70-71
Hearing Protection	382-383
Heat Mat	398



Heat Shrink Butt Connectors	23, 32, 500
Heat Shrink Terminals	23, 32, 500
Heat Shrink Tubing	23, 38
Heat Tolerant Gloves	376
Heater Bulbs (Infra-Red)	81
Heater Hose	216
Heater Spares (Gas)	396-397
Heater Switches	397
Heavy Duty Crimping Pliers	58
'HelaCon' Mini Wire Connectors	35
Helicoil Type Kits	124

HellermannTyton

HELLERMANN TYTON	35, 57
Helmets (Safety)	377
HENRY Type Vacuum Kits	351
Hex Bit Socket Adaptor	446, 447

Hex Bit Sockets	458, 459, 460
Hex Drivers	414-451
Hex Key Wrenches	414-451
Hex Keys	414-451
Hex T-Handles	414-449
HEXPRO Pivot Head Wrenches	449
Hi Vis Vests	384
HID Gas Discharge Bulbs	83, 87, 94
Hide Rigger Gloves	376
High Build Etch Primer	313
High Strength Epoxy	327
High Strength Retainer	327
High Strength Threadlocker	326
High Temp Aluminium Anti-Seize	305
High Temp Instant Gaskets	332, 333, 334
High Temp Silicone Sealant	333, 334
High Tensile Bolts	117
High Visibility Air Hose	219
HILCO Welding Electrodes	391
Hi-Vis Parka	384
Hole Plugs	181, 183



Hole Saws	424
-----------	-----



HOLTS	308, 336
HONDA Trim Clips	191-192
Hone Kits	472
Hone Stone Replacements	472
Hone Stones	472
Hones + Pullers	472-473
Hook & Loop Tapes	321
Hook & Pick Tools	477
Hooks & Chains (Roller Shutter)	271
HORIZON	472, 473, 440, 476, 478
Hose (Air Line)	218-219
Hose (Auto)	216-217
Hose (Breaker)	284
Hose (Compressor)	217, 284
Hose (Hydraulic)	217, 284
Hose (Pressure Washer)	218
Hose (Vacuum Cleaner)	351-354
Hose + Tubing	204-219
Hose + Tubing Tools	208-209
Hose Clamp	209
Hose Clamp Pliers	209
Hose Clip Drivers	208
Hose Clip Tools	208



Hose Clips	19, 202-206, 504
Hose Clips (JCS)	202-203, 504
Hose Clips (JUBILEE)	204-205
Hose Clips (Mini)	19, 203, 206, 504
Hose Clips (NORMA)	206
Hose Clips (TERRY)	205
Hose Clips Dispensers	202-205
Hose Connectors	205
Hose Connectors (Air Line)	219
Hose Connectors (Brass)	205





Hose Reel (Air Line)	219
Hose Reel (Water)	218, 354
Household Rubber Gloves	377
HSS Jobber Twist Drills	416-421
HSS Taper Drills	421



Hummer Type Discs	408
HVLP Spray Guns	228



HYDE Scrapers	428
Hydraulic Accessories	217, 282-284
Hydraulic Bead Breaker	245
Hydraulic Couplings	282
Hydraulic Fittings	282-283
Hydraulic Hose	217, 284
Hydraulic Jacks	248, 249, 470, 471
Hydraulic Lubricating Oil	284, 306
Hydraulic Oil	284-285
Hydrophobic Paint Guard	295



HYLOMAR Exhaust Repair	336
HYLOMAR Gasket Sealants	332
HYLOMAR 'Hylolyte Red'	332
HYUNDAI Trim Clips	192-193

I	
Ice Scraper	290
IFAM Padlocks	484-486
Igniter (Gas Heater)	397
IGUANA Wiper Blades	268
Illuminated Lights (Switch Type)	42
Illuminated Switches	43, 44
Impact Adhesives	328
Impact Drive Adaptors	465
Impact Drive Reducers	465
Impact Driver Sets	466
Impact E-TORX Sockets	466
Impact Extensions	465
Impact Screwdrivers	466
Impact Socket Sets	466
Impact Universal Joint	465
Impact Wrenches (Pneumatic)	227
Indent Crimping Tool	59
Indicator Lights (LED)	42
Industrial Wipes	348
INFINITI Trim Clips	195
Infra-Red Bulbs	81
Injector Cleaner (Throttle Body Cleaner)	301
Injector Washers	135
In-Line Fuel Filters	258
Insert Replacement Packs	124, 423
Insert Tool	125
Inserts (Threaded)	124-125
Inspection Lamps	73-76
Inspection Mirrors	481
Inspection Tools	481
Instant Adhesive Activator	325
Instant Adhesives	324-325
Instant Contact Adhesive	328-329
Instant Gasket	333

Instant Gasket Silicone Sealant	333
'Instant Valay'	291
Insulated Terminals	22-23, 28-32, 500



Insulation Tapes	39, 323, 501
Integral Adaptor/Tailpieces (Air Line)	220, 221, 223
Interior Protection Set	298
Interior Strip Lights (LED)	80, 279
Inverters (Power)	104
Iron Pipe Fittings	214-215
IRWIN VISE-GRIP Pliers	434
ISOL8 Organic Absorbent	336
Isolator Switches (Battery)	45
ISUZU Trim Clips	193
IVECO Trim Clips	190

J	
Jab Saw	427
Jack Knife	428
Jackets (Safety Clothing)	384
Jacks (Hydraulic)	248, 249, 470, 471
JAMEC PEM Air Products	218-233
Janitorial Products	346-350



J-B Industro Weld	328
J-B Kwik	328
J-B WELD	328
JCASE Cartridge Fuses	50



JCS	202-203, 208, 504
JEEP Trim Clips	188-189
JENOLITE Rust Converter	311
JENOLITE Rust Remover	311



Jerry Cans	355
Jewellers Style Screwdrivers	445
JEYES FLUID	346



JG 'Speedfit'	18, 209, 209-211
JG 'SuperThread' Fittings	205
Jigsaw Blades	427
J-Nuts	14, 148
Jobber Drills (ALPEN)	418-421
Jobber Drills (DORMER)	416-417
Jobber Twist Drills	416-421
JOHNSTONE'S Paint	315
Joints (Universal)	457
'Jubilee' Cutting Discs	409
JUBILEE Hose Clips	204-205

Jugs (Measuring)	358-359
Jump Lead Clips	106
Jump Leads	106
Jump-Starters	106
Junior Hacksaw Blades	426
Junior Hacksaws	426

K	
Karabiner	388
KÄRCHER Type Vacuum Kit	354
Kentucky Mop & Bucket	350
Kevlar Gloves	375
Key Steel	18, 160
Keyless Drill Chucks	422
Keyring Indicators	487
Keys (Woodruff)	18, 160
KIA Trim Clips	192-193
Kick Step	494
KN95 Face Masks	365
Knee Pads	385
Knife (Jack)	428
Knife (Pocket)	428



Knife Blades	428-430, 504
Knives	428-430
Knives (Stanley Type)	429
Knives (Trimming)	428-430
Knives + Blades	428-430
KOLOR KUT Water Finding Paste	285
KRINO Drill Sets	419



KS TOOLS	41, 58, 394, 395, 401, 403, 407, 428-430, 439, 440-443, 445-447, 451-466, 468-469, 473-481, 482
KS TOOLS 'ERGOTORQUE'	208, 468
KS TOOLS 'GEARplus'	454
KS TOOLS 'TRIPLEplus'	459
KS TOOLS 'TRUCKplus'	469

L	
Label & Gum Remover	301
Ladders (Step)	494
Ladyfoot Pry Bars	439
Lamp Holders (Heater)	81
Lamps (Hand)	73-76
Lamps (Work)	77, 278
LANCIA Trim Clips	190
LAND ROVER Trim Clips	193
Lane Marking Tapes	322
Lantern Batteries	112
Lanyard (Safety Harness)	388



LAP ELECTRICAL Beacons	78-79, 280
LASER TOOLS	401, 447, 455, 456, 466, 473, 477, 479, 481
Latex Coated Grip Gloves	375
Latex Gloves	374
Layflat Tubing (Polythene)	495
Lazy Tong Riveter	154-155
Lead Connectors	65
Leads (Jump)	106
Leak Detector	299

'Leak Fix' (TEROSON)	331
Leak Off Bungs	216
Leak Stopper	288
Leak UV Dyes	299
Leather Cleaner	294
LED Amber Beacons	78-79, 280-281
LED Auto Bulbs	90, 95-101
LED Bar (Amber Beacon)	79, 281
LED Blade Fuses	25, 46
LED Domestic Light Bulbs	81
LED Headlight	70-71
LED Illuminated Lights (Indicator)	42
LED Illuminated Switches	43, 44
LED Inspection Lamps	73-76
LED Light Bulbs (Domestic Type)	81
LED Lights	70-76
LED Resistor Kit (Cambus)	98
LED Rotating Beacons	78, 79, 280, 281
LED Tail Lamps	274, 276-277
LED Torches	72-73
LED Trailer Lights	274, 276-277
LED Work Lamps	77, 278
LED Worklights	76



LEDLENSER	70-72, 76
LEDLENSER Hand Lamps	76
LEDLENSER Head Torches	70-71
LEDLENSER Torches	72
Leg Pullers	473
Lemon Channel Blocks	346
Lenses (Welders Face Shield)	390
Lever (Tyre Mounting)	244
Lever Action Hand Pump	303
Lever Bolt Cutters	430
LEXUS Trim Clips	197
Lift Spray Cleaner	347
Lifting Slings	273
Light Bulbs (Domestic Type)	81
Lightbars (Amber)	281
Lighters (Flame Torches)	395, 398
Lighters (Flint)	393



Linch Pins	157
Line Markers	315
Liquid Buffer	241
Liquid Handling Products	354-359
LISTER Vehicle Wash Brush	296
Lithium Batteries	111, 112, 501
Lithium Cells (Coins)	112, 501
Lithium Grease	304, 305



LITTELFUSE	24, 25, 46-51
LITTLE TREE Air Fresheners	296
Lock & Seal	326
Lock Lubes	307-308
Lock Nuts (Nylon)	7, 127, 502
Lock Washers	8, 132
Locking C-Clamps (VISE-GRIP)	434
Locking Extensions	457
Locking Hinge	26, 493
Locking Nuts (Plastic)	15, 174-175, 499



Locking Nuts (Steel)	7, 127, 502
Locking Pliers (VISE-GRIP)	434
Locking Welding Clamps (VISE-GRIP)	434
Locking Wheel Nut Remover Kit	246, 477
Locking Wire	270

LOCTITE

LOCTITE Products	311, 328
Long Arm Riveter	154-155
Long Knife For Scraping	429, 479
Loom Tape	38-39
'Loop' Tape (Hook & Loop)	321
Lotion Soap	339, 340, 342
Louvered Panels	490, 491
Low Profile J-CASE Fuses	50
Low Profile MINI Blade Fuses	25, 48
LPG Accessories	396-397
Lubes (Aerosol)	307-310
Lubricants + Maintenance	307-308
Lug Nuts (Chimney Nuts)	14, 149
Lump Hammers	438

M

M.O.T. Signs	373
Machine Screws	5, 123-124
Macpherson Strut Coil	
Spring Compressor	473
MAGIC TREE Air Fresheners	296
Magnetic Bit Holders	446, 447
Magnetic Bits Trays	488
Magnetic LED Hand Lamps	73-76
Magnetic LED Work Lamps	77, 278
Magnetic Pick-Up Tools	481
Magnetic Protective Wing Cover	298
Magnetic Tool Rail	488
Magnetic Trailer Lights	274, 276
Mains Cable	63
Mains Fuses	47, 64, 501
Mains Plugs	64
Mains Rubber Plugs	64
Mains/Transformer Plugs & Sockets	65-66



Maintenance & Lubricant Sprays	307-308
Malleable Pipe Fittings	214-215
Mandrel Kits	125
Manifold (Gas)	396
Manifold Studs & Nuts	20, 119, 267
MARKAL 'B Paintstik' Markers	239
Marker Boards	275
Marker Pens	315, 398
Markers (Yellow)	239
Marque Badge Tape (Transparent)	320



Masking Tapes	320
Masks (Dust)	380-381
Masks (Face)	350, 361

Masks (Full Face)	382
Masonry Drills	421
'Master Cobalt' Hole Saws	424
Matt Black Paint	314
MAXI Blade Fuses	24, 25, 49
MAXI Fuse Holders	49
'Maxiboot' Universal CV Boot Kit	250



MAYHEW	439-441
MAZDA Trim Clips	193
MCB Circuit Breakers	66-67
Measuring Jugs	358-359
Measuring Kit (TENG TOOLS)	437
Measuring Tapes	437
Measuring Tools	437
Mechanical Leg Puller	473
Mechanics Anti-Vibration Gel Gloves	374, 469
Mechanics Grip Gloves	374, 469
'Medsan' Sanitising Cream	338
MEGA Bottle Jacks	249, 471
MEGA Fuses	51
Memory Card	68
MERCEDES-BENZ Trim Clips	193-195
Message Signs/Stickers	371
Metal Cable Ties	56
Metal Content Cable Ties	57
Metal Cutting Discs	408-410
Metal Grinding Discs	411
Metal Polish (AUTOSOL)	299
Metal Putty	327
Metal Staples	155
Metal Stays	349
Metal-Halide Bulbs	80, 279
Micro Fibre Towels	297
Micro SD Memory Card	68
Micro Soldering Kit	395
MICRO2 Fuses	25, 48
MICRO3 Fuses	48
Micro-fine Gloves	375
Micrometer (Measuring Set)	437
Mig Torch Spares	392
Mig Welding Sundries	392-393



Mig Wire	392
Mill Cutter Tools	242
Milling Cutters	242
Mini Air Tools	226
MINI Blade Fuse Holders	48-49, 501
MINI Blade Fuses	24, 25, 48-49
Mini Hacksaw Frame	426
Mini Hose Clips	19, 203, 206, 504
Mini Pipe/Tube Cutter	209
Mini Screwdrivers	444, 445
MINI Trim Clips (BMW)	187-188
Mini Type Blade Fuses	24-25, 48-49, 501
MITSUBISHI Trim Clips	195
'Mk4' Air Line Gauge	231
MO2 Lithium Grease	304

MOLDEX

MOLDEX PPE Range	346-383
Moly Anti-Scuff Paste	304

Monobolts	153
Mop Buckets	350
Mop Heads	350



MORSE	424, 425, 427
MORSE Hacksaw Blades	425
MORSE Hacksaw Frame	425
MORSE Hole Saws	424
MOT Corrosion Hammer	271
MOT Plate Holders	270



MOTIP Repair Adhesives	330-331
Moulding Clips	179-180
Mounting Paste Brushes	241
Mounting Rings (Exhaust)	267
Mouting Lever	244
MP3 Lithium Grease	304, 305
MS-Polymer Sealants	335
Mule Skinner	400
Multi Gaskets	332
Multi Shine	291
Multifunction Tail Lamps	274, 276-277
Multigrip Rivets	15, 152-153, 503
Multimeter	482
Multiple Connectors	34-35
Multi-Purpose Clear Fine Oil	307-308
Multi-Purpose EP Grease	304, 305
Multi-Purpose Maintenance Lubricants	
Multi-Purpose Oil (Aerosol)	307-308
Multipurpose Screws	143
Multi-Use Screws	13, 143
Multi-Wipes	344-345
Mutton Cloths	297, 348

N

Nail Brushes	347
Narrow Band Hose Clips	206
Needle File Set	412
Needle Files	412



NEOLUX Auto Bulbs	82-85
Neutral Detergent	346
NGK Spark Plugs	285



NILCO Air Fresheners	296
'Nilglass'	290
NiMH Batteries	110-111
NiMH Battery Charger	110-111
Nippers (NWS)	430-432
NISSAN Trim Clips	195
Nitrile Coated Gloves	375



Nitrile Gloves	374
----------------	-----

Nitto

NITTO Tapes	39, 323
No Smoking Signs/Stickers	364-365
No. Plate Fasteners	13, 140-141, 503
Non-Slip Tool Mat	488



NORGREN 'Fleetfit' Tube Couplings	206
-----------------------------------	-----



NORMA Hose Clips	206
NORMACLAMP 'Torro' Clips	206
Nose Bush & Mandrel Kits	125
Nozzle Cleaners (Welding)	392, 393
Nozzles (Cutting)	393
Number Plate Adhesive Pads	141, 321



Number Plate Fasteners	13, 140-141, 503
Number Plate Lamp	277



Nut Lock	326
Nut Spinners/Hose Clip Drivers	208
Nutlock	326



Nuts	6-7, 126-128, 502
Nuts (Brake)	20, 252-255, 504
Nuts (Combi)	128
Nuts (Exhaust Manifold)	119, 267
Nuts (Locking)	7, 127, 502
Nuts (Nylon Lock)	7, 127, 502
Nuts (Steel)	6, 126, 502



NWS	208, 430-432, 435-436, 444
Nylon Hose Connectors	205



Nylon Lock Nuts	7, 127, 502
Nylon Seat Cover	298
Nylon Tubing	217

O

O-Clip Crimping Tools	206, 208
O-Clip Installation Pincers	206, 208





O-Clips	19, 206
Odour Eliminator	295, 296
Odour Eliminators	295, 296



OETIKER	206, 208
Oil Absorbent Pads	360, 361
Oil Cans	356
Oil Containers	355
Oil Drain Pans	354
Oil Filter Wrenches	478
Oil Pan Repair Kit	259
Oil Suction Guns	303
Oil Suction Pump	356
Oil/Fluid Drain Pans	354
Oils (Hydraulic Lubricating)	284, 285, 306
Oils (Plant)	284, 285, 306



OLFA Trim Knives & Blades	430
Olives (Barrel & Stepped)	19, 206
OMEGA Bottle Jacks	249, 471
Omega Clips	182
OPEL Trim Clips	198-199
Open Gear Lube	309
Orange Nitrile Gloves	374
Orbital Sander	226, 227
Organic Absorbent	336



O-Rings	11, 138
O-Rings Kit for Air Conditioning	128
O-Rings Service Kits	11, 138
O-Rings Splicing Kit	11, 138



OSBORN Abrasives	406-411
Outdoor Disinfectant	346
Overspecs (Safety)	379
P acking Materials	322, 495
Packing Tapes	495



Padlocks	484-486
Padlocks + Security	484-487
Pads (Spill)	360, 361
Pails (Buckets)	354
Paint & Gasket Stripper	301
Paint (Aerosols)	312-315
Paint (Floor)	315

Paint (Gloss)	315
Paint (Marker Pens)	315, 398
Paint Brushes	317
Paint Drying Gun	228
Paint Guard (Hydrophobic)	295
Paint Kits (Roller)	316
Paint Rollers	316
Paint Trays	316
Paint Trays Spares	316
Paints + Primers	312-315
'Paintstik' Markers	239
PAL Auto Fuses	50
Palm Blow Gun	228
Panel Bulb Kits	101
Panel Bulbs	101
Panel Clips	15, 176-179, 499
Panels (Wall Louvred)	490, 491
Paper Floor Mats	298



Paper Rolls	347
Paper Towels	347
Paper Wipes	347
Parka	384
Parking Permit/License Holders	269
Parts Cleaning Brush	401, 481
Patch Stitcher	239
Patches (Tyre Repair)	238, 239
PCL	219-234, 419
PCL Air Tools	226-227



P-Clips	24, 52, 501
Pen (Paint Marker)	312-313, 398
Pen Lights (LED)	72
Pencils (Markers)	239
Penetrating Oil (Graphited Lubricant)	309
Perforated Strip	266
Petrol Engine Treatment	288
PEUGEOT Trim Clips	189
Pick Tools	477
Pickup Tools (Magnetic)	481
Piezo Ignitor (Gas Heater)	397
Pilot Drills (MORSE)	424
Pilot Punches	441
Pin Punches	440, 441
Pink Lotion Soap	339
Pins (Door Hinge)	159
Pins + Clips (Hardware)	156-159
Pipe Benders	440
Pipe Connectors (Windscreen Washer)	217, 269

Pipe Cutters	209
Pipe Fittings	214-215
Pipe Flaring Tools	440-475
Pipe Joiners	205
Pipe Repair Kit	19, 205
Pipe Sealants	335
Pipe/Cable Clips	182-183
Pipe/Rod Clips	182-183, 206
Pipe/Tube Cutters	209
Piston Wind Back Kit	475
Pivot Head Wrenches	449
Plasters (Adhesive)	362

Plastic Hose Connectors	205
Plastic Nail Brushes	347
PLASTIC PADDING (TEROSON)	331
Plastic Rivets	184
Plastic Storage Boxes	488-493
Plastic Sump Plugs	259
Plastic Tape	39, 323, 501
Plastic Tool Box	488
Plastic Wall Plugs	144, 416
Plastic Wedge Set	172, 477
Plastics Super Glue Kit	324



Pliers	434-436
Pliers (Circlip)	436
Pliers (Combination)	434-435
Pliers (Cutting)	430-432
Pliers (O-Clip)	206, 208
Plug Patches	239
Plug-In Bases (Relay)	41
Plugs & Couplers	65-66
Plugs & Sockets (Trailer)	274
Plugs (Domestic Mains)	64
Plugs (Spark)	285
Pneumatic Air Tools	226-227
Pneumatic Brake Bleeders	473
Pneumatic Compact Impact Wrench	226
Pneumatic CV Boot Gun	250
Pneumatic Die Grinder	226, 227
Pneumatic Impact Wrench	227
Pneumatic Orbital Sander	226, 227
Pneumatic Ratchet	226, 227
Pneumatic Reversible Drill	227, 419
Pocket Knives	428-429
Pocket LED Hand Lamps	73, 76
Pocket Screwdrivers	444, 445
Pocket Torch	72
Pocket Type In-Line Head	233
Pole - DIN (for Amber Beacons)	78, 79, 280, 281

Polish (Vehicle)	293
Polishing Cloths	297, 348
Polishing Discs	407
Polishing Flap Discs	406, 407
Polishing Kit	407
Polishing Wheels	407
Poly Coated Wire	270
Polycloth Duct Sealing Tapes	321
Polyester Putty (MOTIP)	330-331
Polythene Bags (Packing)	495
Polythene Sacks	348
Polythene Woven Tarp	272



Polyurethane Repair Adhesives (2K)	329
Polyurethane Sealant	335



POP AVDEL Rivets	15, 151, 153
Portable Welding Machine	398
Posters - Trim Clip	161, 200

Power Bars	456
'Power Bond' MS-Polymers	335
Power Drive Extensions	456
Power Hacksaw Blades	426
Power Inverters	104
'Power Mix'	
Polyurethane Repair Adhesive	329
Power Packs (Jump Start)	106-107
Poweraw Blades	426
PPE Signs/Stickers	372
Precision Screwdriver Set	445



PRESSOL Funnels	359
PRESSOL Grease Gun	303
PRESSOL Sprayers	357
Pressure Gauges	233
Pressure Sprayers	357
Pressure Washer Hose	218
Pre-Work Protective Cream (Barrier Cream)	338, 343
Primer Adhesion Promoter	312
Primers (Aerosols)	304-315



PROCELL Batteries	108
Production Papers	402
Prohibitory Signs/Stickers	365
Propane Gas Accessories	396-397
Propane Gas Regulators	396
Protective Cream (Barrier Cream)	338, 343
PROVIDUS+	394, 398
Pry Bars	439-440
PSA (Citroen/Peugeot) Trim Clips	189



PTFE Tape	335
PTFE Thread Sealing Tape	335
PU Coated Gloves	375
Pull Knife (Windscreen)	480
Puller (Battery Clamps/Windscreen Wiper Arms)	479
Pullers	473
Pump (Foot)	234
Pump (Lever Action)	303
Pump (Oil Suction)	356
Pump Action Sprayers	357
Pumps (Syphon)	300, 356
Punch & Chisel Set	440
Punches	440-441
Punches (Flaring Tool)	475
Puncture Repair Kit	239
Push Button Switch	44
Push Rivets	165-167, 498
Push/Pull Switches	45
Push-Fit Tube Couplings	18-19, 210-213
Push-on Fixes	14, 150
Putty (Repair)	330-331
PVC Coated Wire	270
PVC Gauntlets	376
PVC Gloves	376
PVC Insulation Tapes	39, 323, 501



PVC Tape	39, 323, 501
PVC Tubing	217
PX24 Industrial Lubricant (Aerosol)	308
PYTHON File Handles	412

Q

Q-BOND Adhesive System	329
Quick Change Abrasives	404, 405
Quick Connector Fittings	215
Quick Metal Liquid	327



Quick Metal Putty	327
Quick-fit Couplings	210-213

R

Rack ('AB' Storage Box)	26, 493
RAD Repair Patches	238
Radiator Cement	288
Radiator Hose Clamp Pliers	209
Radiator Leak Stopper	288
Radiator Sealants	288
Radio Installation & Removal Set	478



Rags-In-A-Bag	348
Rain Suit	385
Rapid Epoxy	327
Rasp & File Set	412
Ratchet (Pneumatic)	226, 227
Ratchet + Socket Sets	457
Ratchet Accessories	456-457
Ratchet Crimping Pliers	58
Ratchet Pipe/Tube Cutter	209
Ratchet Screwdriver Set	443
Ratchet Straps	272
Ratcheting Spanners	454
Ratchets	455



Razor Blades	428
'Razor-Mate' Scrapers	428
RCD Circuit Breakers	66-67
RCD Safety Adaptor	64
R-Clip Module Assembly	158, 271
R-Clips	17, 158, 504
Rear View Mirror Bonder (LOCTITE)	324
Rechargeable Batteries	110-111
Reciprocating Saw Blades	427
'ReCyko+' Rechargeable Batteries	110
'Red Extra' Welding Electrodes	391
Red Hand Gel	339, 341
Red Oxide Primer	314
Red Rubber Grease	304, 305
Reflective Tape	322
Reflectors	275
Refractometer	482
Refrigerant UV Dye	299
Refuge Bins	348
Refuse Sacks/Liners	348
Regroover (Tyre)	245

Regrooving Blades	245
Regular Impact Sockets	464, 465
Regular Sockets	458-463
Regulator (Air)	228
Regulator Tails	396
Regulators (Gas)	396
Relay Plug Blocks	41
Relays	41
Releasable Chassis Cable Ties	57



REMA TIP TOP Tyre Products	238-241, 242, 245, 248, 470
----------------------------	-----------------------------

Remote Batteries	112, 501
Removal Tools	476-479
RENAULT Trim Clips	196
RENOLIT Greases	304
Repair Adhesives	329-331
Repair Adhesives (2K Polyurethane)	329
Repair Patches (Tyre)	238, 239
Repair Tape (Clear)	321



Repair Washers	9, 129, 502
Resin (Repair)	330-331
Respiratory Protection	380-382
Retainers (Adhesives)	326-327
Rethreading Tap & Dies	422-423
Reusable Ear Plugs	382-383
Reversible Drill (Pneumatic)	227, 419



Reversible Ratchets	455
Reversible Wrenches	454
RICHTER Dipping Tape	285
Rigger Boots	386
Rigger Gloves	376
'Rigger Jigger' (Spanner)	452



RING Auto Bulbs	82-103
RING AUTOMOTIVE	68, 73, 74, 76, 77, 79, 80, 81, 82-107, 278
RING Chargers & Inverters	104-105, 107
Ring Spanners	452-454
RING Tyre Repair (Aerosol)	235, 242
Ringling Gel Hand Cleaners	339
Rivet Guns	154-155
Rivet Washers	151, 132
Riveters	154-155



Rivets	15, 151-153, 503
Rivets (Aluminium)	15, 151-153, 503
Rivets (Blind)	151-153
Rivets (Bulbex)	151
Rivets (Drive)	15, 168-169, 498
Rivets (Multigrip)	15, 152-153, 503

Rivets (Plastic)	184
Rivets (POP AVDEL)	15, 151, 153
Rivets (Push)	15, 165-167, 498
Rivets (Screw-Type)	170-172
Rivets (Trim Clips)	15, 151, 184, 498-499
Rivets + Riveters	15, 151-155, 184, 503
ROCK OIL Hydraulic Oil	285, 306
Rocker Switches	42-43
Roll Pin Punches	441
Roll/Heel Bars	439
Roller Shutter Hooks & Chains	271
Rollers (Paint)	316
Roofing Bolts & Nuts	118
Rope Hooks	271
Ropes (Polypropylene)	272
Rotary Burrs	413
Rotating Beacons	78-79, 280-281
Round Bar	160



ROZALEX Hand Care Products	338, 340
'Rozsan' Sanitising Gel	338



RTV Silicone Sealants	333
Rubber Care	250, 310
Rubber Eraser Pad	400
Rubber Gloves	377
Rubber Grease	304, 305
Rubber Lined P-Clips	52, 501
Rubber Marker Lamp	277
Rubber Squeegees	350
Rubbish Bins	348
Rulers (Steel)	437
Rust Convertor	311
Rust Cure	311
Rust Remedy	311
Rust Remover	311
Rust Repair	311
Rust Treatment	311

S



S-A-S Range	41, 250, 269, 288-295, 299, 300-301, 304-315, 325-327, 332, 333, 335, 336, 338, 340-341, 344, 346, 393, 395, 416
-------------	--



S-A-S Universal Maintenance Lubricant	307
---------------------------------------	-----

Sack Trucks	494
SafeSaw System	426
Safety Adaptor (Domestic Mains)	64
Safety At Height	388
Safety Boots	386
Safety Clothing	384-385
Safety Couplings (Air Line)	221, 223
Safety Cut Out Switch (Heater)	42, 80
Safety Glasses	378-379
Safety Goggles	378-379
Safety Harness	388
Safety Helmets (Hard Hats)	377
Safety Shoes	386-387



Safety Signs/Stickers	364-373
Safety Spectacles	378-379
Safety Valves (Air Line)	223
'Sandflex' Hacksaw Blades	425
Sanding Blocks	403
Sanding Discs	404-405
Sanitiser Cream	338
Sanitiser Gel	338
Sanitising Wipes	346
SAS Universal Maintenance Lubricant	307
Satin Black Paint	314
Saw Blades	425-427
Saws	424-427
Saws (Hole)	424
SC JOHNSON Hand Care	342-343
Scissors	430
'Scotch Auto' Masking Tape (3M)	320
Scotchlok Connectors (3M)	35
Scraper (Ice)	290
Scraper (Tyre Inner Liner)	244
Scraper Tool	428
Scrapers	428
Screen Wash	269, 289
Screw & Stud Extractors	476
Screwdriver Bits	446, 447
Screwdriver Pry Bars	440
Screwdriver Sets	442-445



Screwdrivers	442-445
--------------	---------



Screwed Adaptors	220, 221, 223, 224
Screwed Rod	119
Screws (Self-Drilling Screws)	145
Screws (Self-Tapping)	12-13, 142-147, 503
Screws (Sheet Metal)	14, 145-147, 503
Screw-Type Rivets	15, 170-172, 499
SCRUBS-IN-A-BUCKET Hand Wipes	344
Sealants	332-335
Sealants (MS-Polymer)	335
Sealants (Polyurethane)	334
Sealants (Silicone)	333
'Sealastic' Tyre Repair	240
'Sealfix' String (Tyre Repair)	240





Sealing Washers	10, 134-138
Seam Sealer (VIP)	335
Seat Covers	298
SEAT Trim Clips	185-187
Security Bits	446, 447
Security Chains	485
Security Number Plates	13, 141, 503
Security Padlocks	485-486
Security Seals (Ties)	487
Self-Amalgamating Tape	38, 39
Self-Drill Fixings	145
Self-Drilling Screws	145
Self-Fusing Silicone Rubber Tape	38



Self-Tapping Screws	12-13, 142-147, 503
SELSON Air Jack Bellows	249, 471
Serrated Flange Nuts	128
Service (Automotive)	298-299



Set Screws	2-3, 114-116, 502
Set Screws (Flanged)	116
Shades (Protection Glasses)	378-379
Shears	430
Shears (Cable)	59, 431



Sheet Metal Screws	14, 140-141, 503
Sheet Metal Screws (Body Screws)	145-147

Shelving Systems	489, 491
Shim Washers	8, 132
Shock Freeze Spray	308
Shoes (Safety)	386-387
Shovel (Extending)	290
Shrouds (Welding Torch)	392
Shunt Release Switch	66
Shunt Trip Switch	66
Side Cutters	430-432
Side Marker Lamp	277
Side Moulding Clips	179-180

sif

SIF Welding Products	391, 393
'Sifbronze No. 1' Brazing Rods	391
'Sifredicote' Brazing Rods	391
'Sifsteel No. 11' Welding Rods	391
Signograph (Electric Engraver)	437
Signs (Safety)	364-373
Silage Tape (Farmers)	323
Silencer Repair Paste	336
Silicone Copper (LOCTITE)	332
Silicone Free Multi-Shine	291
Silicone Grease	304, 310
Silicone Hose	216
Silicone Rubber Tape	38
Silicone Sealant (High Temp)	333, 334
Silicone Sealant (Instant Gasket)	333
Silicone Sealant (RTV)	333

Silicone Sealants 332-334

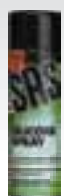

Silicone Spray	310
'Silkair' Airline Oil (FUCHS)	227
Silver Paint	314
SIROFLEX Expanding Foam	334
SIT 'SPID' Brushes	401
SKODA Trim Clips	185-187
Sledge Hammers	438
SLEEPSAFE Smoke and CO Alarms	363
Sleeve Anchors	118
Slide Vernier Caliper	437
Slide-on Connectors	302
Sliding T-Bar Adaptors	457
Slimline LED Hand Lamp	73, 76
Slings (Lifting)	273
Slotted Screwdrivers	442-445
'SmartCharge' Battery Chargers	105
Smoke Alarm	363
Snap-Lock Connectors	35, 501
Snow Foam	292, 295
Snow Shovel	290
Soap (Lotion)	339
Soap Dispenser Units	339, 341, 342, 343
Socket Accessories	456-457
Socket Cap Screws	4, 120-122
Socket Rail Sets	460
Socket Screws	4, 120-122
Socket Sets 1/4" Drive	458, 460, 461
Socket Sets 3/8" Drive	458-461
Socket Sets 1/2" Drive	459, 461
Sockets	458-466
Sockets & Plugs	65-66
Sockets & Plugs (Trailer)	274
Sockets (1/4" Drive)	458, 460-463
Sockets (1/2" Drive)	459, 461-466, 469
Sockets (3/8" Drive)	458-463
Sockets (3/4" Drive)	465
Sockets (1" Drive)	465
Sockets (Impact)	464-466
Sockets (Trailing)	274
Socks (Absorbent)	360, 361
Soft Face Hammer	439



Solder	394
Solder Wire	394
Soldering	394-395
Soldering Flux	394
Soldering Gun	395
Soldering Iron	394
Soldering Kit	395
Soldering Wire Holding Pliers	394
Solderless Nipples	271
Solvent Cleaner (Aerosol)	301
Solvent Sprayer	300, 357-358
Spacelock	486
Spanner (Gas Bottle)	396
Spanner Organizer	452
Spanner/Cylinder Keys	392



Standard Crimping Pliers	58
Stands - Axle	248, 470
Stands - ESSENTIALS	496
'Stanley' Type Knife Blades	429
Staple Gun / Staples	155
Staple Tacker	155
Staples	155

Spanners	452-454
Spark Plug (Heater Spare)	397
Spark Plug Sockets	461
Spark Plug Thread Repair Kit	423
Spark Plugs	285
Speaker Cable	63
SPEAR & JACKSON Screwdriver	444
Special Blue Cement	239
Spectacles (Safety)	378-379
Speed Fasteners	14, 148-149
Speedfit Couplings	18, 210-212
SPID Brushes	401
Spill Kits	360, 361
Spillage Products	360-361
Spiral Binding	53
Splash Proof Fuse Holders	47-49



Split Pins	16, 158-159, 504
Split Point Jobber Twist Drills	420
Sponges	297



Spot Weld Drills	420
Spray Adhesive	325
Spray Applicators (S.A.S.)	307
Spray Guns	228
Sprayer (Duck Oil)	308



Sprayers	300, 357-358
Spreader (Plastic Filler)	331
Spring Compressor	473
Spring Fasteners	150
Spring Pipe Clip Pliers	208
Spring Roll Pins	16, 159
Spring Washers	9, 131
Springs	159
Springs (Accelerator & Clutch)	21, 159, 258
Springs (Expansion/Compression)	18, 159
Squeegees (Floor)	350

SSI SCHAEFER

SSI SCHAEFER Storage Bins	491-492
Stainless Steel Flat Washers	131
Stainless Steel Hose Clips	203
Stainless Steel Nuts	127
Stainless Steel Nylon Lock Nuts	127
Stainless Steel Self-Tapping Screws	12, 142
Stainless Steel Set Screws	2, 115
Stainless Steel Spring Washers	9, 131



Storage Bins	488-493
Storage Boxes	26, 488-493
Storage Containers + Cabinets	489
Storage Rack for 'AB' Boxes	26, 493



STP Additives	288
Straps (Ratchet)	272
Striking Tools	438-441
Strip Lights (LED)	80, 279
Strip-It Discs	405
Structural Bonding Adhesives	327-329
Stub Drills	421
Stud 'N Bearing	326
Stud Extractors	476
Stud Lock	326
Stud Welding Pins	393
Studding	119
Studlock	326
Studs & Nuts (Exhaust Manifold)	20, 119, 267

SUBARU Trim Clips	196
Suction Holder Set	480
Suction Lifter	480



Sump Plug Washers	10, 20, 136-137, 264-265
Sump Plugs	259-263
Sump Plugs (Plastic)	259
Sun Glasses	378, 379



Supaseal Connectors	24, 36-37
Super Action Spray	307
Super Epoxy	327



Super Glue	324-325
Super Glue (Gap Filling)	324
Super Glue Gel	324, 325
Super Steel	327
'SuperThread' Fittings	205
Surface Conditioning Discs	405
Surface Degreaser	346
Surge Protector	64
Surgical Type Face Masks	365
SUZUKI Trim Clips	196

Swarfega

SWARFEGA 'Duck Oil'	308
SWARFEGA Hand Care	339, 343
SWARFEGA Hand Cleanser (Buckets)	339, 343

SWARFEGA 'Heavy' Hand Cleanser	339, 343
--------------------------------	----------

Swing Bin	348
Switches (Battery Isolator)	45
Switches (Heater & Vacuum On/Off)	42, 353
Switches (Heater Safety Cut Out)	42
Switches (Toggle)	43-45
Switches (Transformer Trip)	65
Swiv Seal Clips	150
Swivel Head Riveters	155
Syphon Pumps	300, 356

T	
Tack Rags	316
Tacker (Metal Staple)	155
Tail Lamps	274, 276-277
Tailpieces	221, 223, 224
Talcum Powder (Tyre)	240
Tamper Proof TORX Key Wrenches	449-451
Tamper Proof TX Screwdrivers	443, 445
Tap & Die Set	422
Tap Wrench	423
Tape (Anti-Corrosion)	321
Tape (Farmers 'Silage')	323
Tape (PTFE)	335
Tape (Reflective)	322
Tape (Self-fusing Silicone Rubber)	38



Tape Guns	322, 495
Tape Measures	437

Taper Drills	421
Tapes (Adhesive)	39, 320-323, 360, 361, 495, 501
Tapes (Insulation)	38-39, 323, 501
Tapes (Measuring)	437
Tapes (Packing)	322, 495
Tapping Screws	12-13, 142-147, 503
Taps (Drum/Barrel)	355
Taps (Hand)	423
Taps + Dies	423
Tar & Gum Remover	301
Tarp	272
T-Bar Adaptors	457
Telescopic Blow Pistol	225
Telescopic Magnetic Pickup Tool	481
Telescopic Pickup Tools	481
Telescopic Reversible Ratchet	455
TEMPLER'S Soldering Flux	394



TENG TOOLS	209, 298, 422, 426, 429, 430, 431, 434-437, 439, 440, 445, 447, 449, 451-457, 458-342, 469, 473, 481
Tensioning Tool (Cable Tie)	58
Terminal Block (Ceramic)	35
Terminal Blocks	35
Terminal Covers	31
Terminals	22-23, 28-33, 500
Terminals (Copper Tube)	33



Terminals (Insulated)	22-23, 28-32, 500
Terminals (Non-Insulated)	23, 31, 33
Terminals (Supaseal)	24, 36-37
TEROSON	331



TERRY 'Powergrip'	205
TERRY Tool Clips	487
Tester (Automotive Multi-Function)	482
Tester (Multimeter)	482
Testers (Anti-Freeze)	482
Testers (Brake Fluid)	482
Testers (Electrical)	482
Testers + Electrical Tools	482
TFR Sprayer	357
T-Handled Hex Drivers	414-449
T-Handled TX/TPX Drivers	449-451
'The Dominator' Screwdriver Pry Bars	440
Thermocouples	397
Thermostat (Gas Heater)	397
Thin (Half) Nuts	128
THOR Hammers	438
Thread Insert Kits	124, 125, 422
Thread Inserts	124-125, 422
Thread Lock	326
Thread Repair Files	422, 479
Thread Repair Kit	124-125, 422-423
Thread Sealants	335
Thread Sealing Tape (PTFE)	335
Threaded Bar	119
Threaded Insert Tool Kits	125



Threaded Inserts	7, 124-125
Threadlockers + Retainers	326-327
Ties (Cable)	54-57, 501
Tin Snips	430
Tip Over Switch	42, 80
Toggle Switches	43-45
Toilet Rolls	347
Tool Box (Plastic)	488
Tool Case	488
Tool Case Trolley	488
Tool Clips	488
Tool Mat	488
Tool Rail	487
Tool Storage	487-488
Tool Tray	488
Torch Spares (Welding)	392
Torches	72-73
Torpedo Fuses	24, 51
Torque Impact Sockets	469
Torque Tools	468-469
Torque Wrenches	468-469
TORX Bit Sockets	458, 459, 460
TORX E-Profile Impact Sockets	466
TORX Impact Bit Sockets	466
TORX Key Wrenches	449-451
Touch Up Brushes	317
Tow Pin Assemblies	271
Towels (Folding Paper)	347
Towels (Valet Drying)	297
TOYOTA Trim Clips	197
Track Rod End Covers	20, 251
Traffic Film Remover (TFR)	295
Traffic Signs/Stickers	365
Trailer Board Extension Lead	274
Trailer Boards	274, 276
Trailer Lights	274, 276-277
Trailer Sockets & Plugs	274
Trailing Sockets (Mains)	64
Trailing Sockets (Trailer)	274
Trainers (Safety Shoes)	387
Transformer Plugs & Sockets	65-66
Transformer Trip Switches	65
Transporter Ratchet Strap	272
Tread Depth Gauges	233
Triangular Reflector	275
Trigger Spray Applicators (S.A.S)	307
Trim Buttons	15, 162-163, 498
Trim Clip Charts	161, 200
Trim Clip Tools	172, 477
Trim Clip Workshop Kit	172
Trim Clips	15, 161-200, 496, 498-499, 504
Trim Knife Blades	429-430
Trim Knives	428-430
Trim Masking Tape	320
Trip Switches (Transformer)	65
Triple Flint Lighter	393
Triple Flints	393
Trolley Jacks	248, 470
Trolleys + Steps	494
Trousers (Safety Clothing)	385
Tube Bending Pliers	440
Tube Coupling Locking/Release Tools	210, 211, 212
Tube Couplings	18-19, 210-213
Tube Cutters	209
Tube Fittings	18-19, 205

Tube Patches	238
Tube Terminals	23, 33, 500
Tubeless Valves	243
Tubing (Copper)	255
Tubing (Nylon)	217
Tubing (Rubber)	215, 216, 217, 219
Tubing Bending Pliers	440
Tubing Connectors	205
Twin Cable	62, 63
Twin Thread Screws	143
Twist Drills	416-421
Twist Sockets	476
TX Bit Sockets	458, 459, 460
TX Keys	449-451
TX Screwdrivers	443, 445
TX-E Bit Sockets	466
Tyre And Mounting Lever	244
Tyre Bath	248, 470
Tyre Cage	248, 470
Tyre Dressing	291, 292, 294
Tyre Fill (Syringe)	242
Tyre Filler (Tank)	245
Tyre Foam	291
Tyre Foot Pump	234
Tyre Gauges	233
Tyre Hand Rasp	240
Tyre Inflators (Compressors)	234-235
Tyre Inflators (Gauges)	229-232
Tyre Lever	244
Tyre Liner Scraper	244
Tyre Pressure Gauges	233
Tyre Reamers	242
Tyre Regroover	245
Tyre Repair (Aerosol)	235, 242
Tyre Repair Products	238-249
Tyre Sealant	241
Tyre Soap	241
Tyre Static Safety Cage	248, 470
Tyre Tread Depth Gauges	232-233



Tyre Valves	242-243
Tyre Valve Caps	243, 504
Tyre Valve Connectors	232
Tyre Valve Core Screwdrivers	244
Tyre Valve Cores	242
Tyre Valve Extension Holders	244
Tyre Valve Extensions	243
Tyre Valve Mounting Tool	244
Tyre Valve Tool	233

U	
ULTRAGRIME Hand Wipes	345
UMETA Grease Nipples	302
Undercoating Gun	228
Universal Blue Gasket Compound	332
Universal Brake Pipe Flaring Tool Kit	440-475
Universal CV Boot Kit	250
Universal Joint (Impact)	465
Universal Joints	457
Universal Maintenance Lubricant (S.A.S)	307
Universal Markers	239
Universal Yellow Markers	239
U-Nuts	14, 148
Upgrade Auto Bulbs	90-93
Upholstery Cleaner	279, 294
USB Battery Charger	110





USB Charging Hand Lamps (LED)	73-75
USB Mains Sockets	64
Utility Knives	429-430
Utility Scissors	430
UV Dyes	299

V	
Vacuum Kits	351-354
Vacuum/Blower Kit	229
Valeting Range	290-297
Valve Core Screwdrivers	244
Valve Extension Caps	243
Valve Extension Holders	244
Valve Extensions	243
Valve Grinding Sticks	258, 288
Valve Holders	244
Valve Mounting Tool	244
Valves (Tubeless)	242-243
VAUXHALL Trim Clips	198-199



VDE Cutting Pliers	59-60, 432
VDE Pliers	432
VDE Screwdrivers	444
Vehicle Interior Protection Set	298
Vehicle Interior Strip Lights (LED)	80, 279
Vehicle Jump-Starters	107
Vehicle Marque Trim Clips	185-199
Vehicle Shampoo	292, 295
Vehicle Wash Brushes	296
Vernier Calipers	437
'Vertex' Couplings	220
Vests (Hi Vis)	384
Vinyl/Nitrile Hybrid Gloves	374



VIP Adhesives/Sealants	312, 329, 335
VIP MS-Polymer Sealants	335



VIP Polyurethane Repair Adhesives	329
VIP 'Power Mix'	329
VIP Primers	312



WISE-GRIP Locking Pliers	434
--------------------------	-----



VISION LED Hand Lamps	74, 76
Visors	344, 390
Voltage Testers	482
VOLVO Trim Clips	199
VTG6A MOT Plate Holder	270
Vulcanising Fluid	239
VW Trim Clips	185-187

W	
Waist Coats (Hi Vis)	384
Wall Panels (Louvred)	490, 491
Wall Plugs	144, 416
Wand Style LED Hand Lamp	74, 75
Warning Signs/Stickers	368-371



WARRIOR	272-273
Wash Brushes	296
Wash Leather	297
Wash Mitts	297
Washer Jet Tool	479
Washer Pump	269
Washer Tubing	269
Washers (Aluminium)	10, 133, 137
Washers (Copper Sealing)	10, 134-138
Washers (Copper)	9, 10, 132-136
Washers (Diesel Injector)	10, 20, 135
Washers (Dowty Type)	9, 135, 137
Washers (Fibre)	9, 133, 137
Washers (Flat)	8, 130-131, 502
Washers (Lock)	8, 132
Washers (Repair)	9, 129, 502
Washers (Rivet)	151, 132
Washers (Sealing)	10, 134-138
Washers (Shim)	8
Washers (Spring)	9, 131
Washers (Sump Plug)	
Washers + Seals	10, 20, 136-137, 264-265
Waste Bins	8-11, 129-138
Water Finding Paste	285
Water Finding Strips	285
Water Pump Pliers	436
Watering Can	354
Waterless Wash & Wax	295
Wax & Wash	292, 295
Wax Spray	295



WD-40	307
Weld Anti-Spatter	393
Welders' Face Shields	390
Welding + Accessories	390-393
Welding Clamp Pliers	434
Welding Curtain	391
Welding Electrodes	391



Welding Goggles	344, 390
Welding Machine	398
Welding Mat	398
Welding Nozzle Cleaners	392
Welding Nozzles	392
Welding Pins (Stud)	393
Welding Protection	390



Welding Rods	391
Welding Sundries	390-393
Wet & Dry Papers	402
Wet Floor Sign	350, 361
Wet Wipes	344-345, 346
Wheel Balancing Weight Pliers	247
Wheel Brushes (Wire)	400
Wheel Chock	248, 470
Wheel Cleaner (Alloy)	292, 294
Wheel Impact Sockets	469
Wheel Nut Indicators	246
Wheel Nut Remover Kit	246, 477
Wheel Nut Sockets	469
Wheel Tools	470-472
Wheel Weight Pliers	247
Wheel Weight Removal Tool	247



Wheel Weights	247
Wheels (Grinding)	399
Wheels + Tyres	238-251
Whip Check Cables	284
Whip Hose (Air Line)	226



White Grease with PTFE	309
White Primer	313
White Rags-In-A-Bag	348
White Spirit	317
Wind Back Tool (Brakes)	475
Windproof Flame Torches	395
Windscreen Cutting Wire	480
Windscreen Cutting Wire Handles	480
Windscreen Products	268-269
Windscreen Sealer (VIP)	335
Windscreen Tools	479-480



Windscreen Wash	269, 289
Windscreen Washer Accessories	217, 269
Windscreen Washer Jet Tool	479
Windscreen Washer Pump	269
Windscreen Wiper Arm Pullers	479
Wing Cover (Magnetic)	298
Wing Nuts	128
Wiper Arm Pullers	479
Wiper Blade Refills	269
Wiper Blades	268-269
Wipes (General Purpose Material)	348

Wipes (Paper)	347
Wipes (Sanitising)	346
Wire (Locking)	270



Wire Brushes	400-401
Wire Connectors	35
Wire Feeder/Starter Tool	480
Wire Handles	480
Wire Rope Grips	271
Wire Strippers	59-60
Wire Wheels	400
Wire Wool	399
Wiring Grommets	24, 37
Wiring Tools	59-60
Wooden Nail Brushes	347
Woodruff Keys	18, 160
Wood screws (Multi-purpose Screws)	143
Work Gloves	375-376
Work Lamps	77, 278
Work Lights	76
Wrench Organizer (for Spanners)	452



Wrenches (Adjustable)	453
Wrenches (Oil Filter)	478
Wrenches (Spanners)	452-454

X	
Xenon Performance Halogen Auto Bulbs	
	90-93
'Xenon150' Auto Bulbs	90-93

Y	
Yellow Marker Pens (Crayons)	239
Z	
ZAPLON Hand Cleaners	340



Zinc Spray	312
'Zing' Hand Cleaner	340
Zip Ties	54-57, 501



'Zippy' Type Scrapers	428
Zirconium Flap Discs	407
'Zorange' Hand Cleaner	340
Z-Swivel Connector	224



BAG13	495	BAT408	109
BAG14	348	BAT408A	109
BAG15	298	BC1	106
BAG17	348	BC2	106
BAG18	272	BC3	106
BAG21	495	BC4	106
BAG22	495	BC5	106
BAG23	495	BC9	106
BAG24	495	BC350	106
BAG30	298	BC500	106
BAG31	298	BN1	253
BAG35	298	BN2	253
BAG36	298	BN3	253
BAG40	298	BN11	252
BAG51	298	BN12	252
BAT1	109	BN13	252
BAT2	109	BN14	252
BAT3	109	BN15	252
BAT4	109	BN16	252
BAT5	109	BN17	252
BAT6	109	BN21	252
BAT7	109	BN41	254
BAT8	109	BN42	254
BAT9	109	BN46	254
BAT10A	112	BN62	255
BAT10N	112	BN63	255
BAT11	111	BN65	255
BAT12	111	BN66	255
BAT13	111	BN67	254
BAT14	111	BN71	257
BAT19	112	BN72	257
BAT21	112	BN81	256
BAT23	112	BN82	256
BAT24	112	BN84	256
BAT25	112	BN85	256
BAT28	112	BN86	256
BAT30	109	BN102	257
BAT32	112	BN103	253
BAT35	112	BN104	253
BAT36	112	BN105	253
BAT37	112	BN106	254
BAT40	112	BN107	255
BAT50	112	BN108	253
BAT51	111	BN109	253
BAT80	111	BN110	253
BAT84	110	BN111	253
BAT105	108	BN112	253
BAT105A	108	BN113	253
BAT106	108	BN114	253
BAT106A	108	BN115	253
BAT107	108	BN116	254
BAT107A	108	BN117	253
BAT108	108	BN118	253
BAT108A	108	BN150	256
BAT109	108	BN151	256
BAT109A	108	BN152	256
BAT117	111	BN153	256
BAT118	111	BN154	256
BAT131	111	BN155	256
BAT151	108	BN156	256
BAT151A	108	BN157	256
BAT185	111	BN158	256
BAT186	110	BN159	256
BAT205	110	BN160	256
BAT206	110	BN161	252
BAT207	110	BN162	252
BAT208	110	BN163	256
BAT209	110	BN164	257
BAT300	109	BN165	256
BAT301	109	BN166	257
BAT305	108	BN167	252
BAT306	108	BN168	252
BAT307	108	BN169	252
BAT308	108	BN170	252
BAT309	108	BN171	254
BAT407	109	BN172	254
BAT407A	109	BN173	255

CAN1	356
CAN2	356
CAN3	358
CAN3A	358
CAN7	357
CAN8	358
CB20	286, 306
CAN11	303, 356
CAN12	300, 357
CAN12K	357
CAN13	357
CAN13K	357
CAN14	357
CAN14K	357
CAN15	300, 357
CAN16	303, 356
CAN17	241
CAN18	303, 356
CAN19	357
CAN20	355
CAN21	355
CAN22	355
CAN23	355
CAN24	355
CAN25	300, 356
CAN26	358
CAN27	286, 295, 357
CAN28	286, 294, 357
CAN30	356
CAN50	300, 356
CAN55	358
CAN56	358
CAN60	300, 356
CAN105	355
CAN110	355
CAN305	355
CAN310	355
CAN320	355
CP11	255
CPR14	42
CPR14M	42
CPR16	42
CPR20	42
CPR25	42
CPR25M	42
CPR30	42
CPR35	42
CPR40	42
CPR40M	42
CPR50M	42
CPR60M	42
CPR70M	42
CPR80M	42
CVB88	250
CVB96	250
CVB96B	250
D	
DB1	413
DB2	413
DB3	413
DB4	413
DB5	413
DB6	413
DB7	413
DB8	413
DB9	413
DB10	413
DB11	413
DB12	413
DB13	413
DB14	413
DB15	413
DB16	413
DB17	413
DB18	413
DB19	413
DB20	413
DB21	413
DB22	413
DB23	413
DB24	413
DBK3	413
DC1	251
DC2	251
DC3	251
DC4	251
DC5	251
DC6	251
DC62	269
DC70	288
DCB1	420
DCB1.5	420
DCB2	420
DCB2.5	420
DCB3	420
DCB3.2	420
DCB3.3	420
DCB3.5	420
DCB4	420
DCB4.5	420
DCB4.8	420
DCB5	420
DCB5.5	420
DCB6	420
DCB6.5	420
DCB7	420
DCB7.5	420
DCB8	420
DCB8.5	420
DCB9	420
DCB9.5	420
DCB10	420
DCB10.5	420
DCB11	420
DCB11.5	420
DCB12	420
DCB12.5	420
DCB13	420
DCD1	410
DCD1B	410
DCD3	410
DCD3B	410
DCD5	410
DCD7	410
DCD9	410
DCD9B	410
DCD23	408
DCD24	408
DCD31	409
DCD33	409
DCD35	409
DCD37	409
DCD39	409
DCD45	409
DCD46	409
DCD51	408
DCD51B	408
DCD52	408
DCD52B	408
DCD56	409
DCD56B	409
DCG1	410
DCG1B	410
DCK6	421
DCK19	420
DCK25	420
DCL62	258
DCL63	258
DCL64	258
DCLP51	408
DCLP52	408
DCLP70	409
DCLP71	409
DDB1	411
DDB2	411
DDB3	411
DDB4	411
DDB5	411
DDB6	411
DDB7	411
DDK19	417
DDK25	417
DDW1	420
DDW2	420
DDW3	420
DDW4	420
DEB1	343
DEB2	342
DEB3	342
DEB4	342

DEB5	343
DEB6	342
DEB7	343
DEB15	339, 343
DEB20	308
DEB21	308
DEB22	342
DEB22C	342
DEB24	342
DEB24B	342
DEB32	342
DEB32C	342
DEB34	342
DEB34B	342
DEB74	343
DEB74B	343
DEB74PP	339, 343
DEB75	339, 343
DEB80A	343
DEB81	343
DEB81B	343
DEB90A	343
DEB91	343
DEB91B	343
DEB112	342
DEB112C	342
DEB114	342
DEB114B	342
DEB142	342
DEB142B	342
DEB200	343
DEB201	343
DEB201B	343
DET1	363
DET5	363
DET6	363
DET7	363
DFD114	406
DFD114A	406
DFD116	406
DFD116B	406
DFD118	406
DFD124	406
DFD126	406
DFD128	406
DFD1110	406
DFD1210	406
DGD2	411
DGD4	411
DGD6	411
DGD8	411
DGD10	411
DGM1	419
DGM1.5	419
DGM2	419
DGM2.5	419
DGM3	419
DGM3.5	419
DGM4	419
DGM4.5	419
DGM5	419
DGM5.5	419
DGM6	419
DGM6.5	419
DGM7	419
DGM7.5	419
DGM8	419
DGM8.5	419
DGM9	419
DGM9.5	419
DGM10	419
DGM10.5	419
DGM11	419
DGM11.5	419
DGM12	419
DGM12.5	419
DGM13	419



DH12	416	DR18	418	DRS20	421	DXM11	417	EBC104	78, 280	EC81	43
DH14	416	DR18L	418	DRST18	421	DXM11.5	417	EBC105	78, 280	EC82	42
DH18	416	DR34	421	DRST32	421	DXM12	417	EBC203	78, 280	EC83	42
DH38	416	DR38	418	DSL21N	289	DXM12.5	417	EBC301	79, 281	EC84	42
DH116	416	DR58	421	DSL31	290	DXM13	417	EBC302	79, 281	EC85	42
DH316	416	DR78	421	DSL40	290			EBC303	79, 281	EC86	44
DH332	416	DR116	418	DSL50	291	E		EBC303G	79, 281	EC87	44
DH516	416	DR316	418	DSL60	289	EAC1	52	EBC305	79, 281	EC88	42
DH532	416	DR316L	418	DSL62	289	EAC2	52	EBL270	80, 279	EC88A	42
DH564	416	DR332	418	DX12	417	EAC3	52	EBL330	80, 279	EC89	42
DH716	416	DR516	418	DX14	417	EAC4	52	EBS570	80, 279	EC89A	42
DH732	416	DR532	418	DX18	417	EAC4BK	52	EBT6087	277	EC90	42
DH764	416	DR564	418	DX38	417	EAC6	53	EBT6095A	277	EC90A	42
DH932	416	DR716	418	DX116	417	EAC9	52	EBT6095R	277	EC91	42
DH964	416	DR732	418	DX316	417	EAC9BK	52	EBT6095W	277	EC92	45
DH1132	416	DR764	418	DX332	417	EAC13	53	EBT7008	276	EC93	45
DH1164	416	DR916	421	DX516	417	EAC26	53	EBT7009	276	EC94	45
DH1332	416	DR932	418	DX532	417	EAC27	53	EBT7058	277	EC95	45
DH1364	416	DR964	418	DX564	417	EAC100	52, 203	EBT7060	277	EC200BK	61
DH1532	416	DR1116	421	DX716	417	EAC105	52, 203	EBT7069	277	EC200BN	61
DH1564	416	DR1132	418	DX732	417	EAC106	52, 203	EBT7085	277	EC200BU	61
DH1764	416	DR1164	418	DX764	417	EAC108	52, 203	EBT7099	277	EC200GR	61
DH1964	416	DR1316	421	DX932	417	EAC110	52, 203	EBT9008	276	EC200PU	61
DH2164	416	DR1332	418	DX964	417	EAC113	52, 203	EBT9550	274, 276	EC200RE	61
DH2364	416	DR1364	418	DX1132	417	EAC116	52, 203	EBT9553	274, 276	EC200WH	61
DH2564	416	DR1532	418	DX1164	417	EAC121	52, 203	EBT9711	277	EC200YE	61
DH2764	416	DR1564	418	DX1332	417	EAC125	52, 203	EBU007	102	EC300BK	61
DH2964	416	DR1764	418	DX1364	417	EAC129	52, 203	EBU027	102	EC300BN	61
DH3164	416	DR1964	418	DX1532	417	EAC135	52, 203	EBU033	102	EC300BU	61
DHK19	416	DR2164	418	DX1564	417	EAC138	52, 203	EBU034	102	EC300GR	61
DHK25	416	DR2364	418	DX1764	417	EAC144	52, 203	EBU077	102	EC300PU	61
DHM1	416	DR2564	418	DX1964	417	EAC148	52, 203	EBW1	77, 278	EC300RE	61
DHM1.5	416	DR2764	418	DX2164	417	EAC152	52, 203	EBW2	77, 278	EC300WH	61
DHM2	416	DR2964	418	DX2364	417	EAC160	52, 203	EBW3	77, 278	EC300YE	61
DHM2.5	416	DR3164	418	DX2564	417	EAC405	52	EBW4	77, 278	EC400BK	62
DHM3	416	DRC1	422	DX2764	417	EAC406	52	EBW5	77, 278	EC400BN	62
DHM3.2	416	DRC2	422	DX2964	417	EAC409	52	EBW6	77, 278	EC400RE	62
DHM3.3	416	DRC5	422	DX3164	417	EAC412	52	EC9	43	EC500BK	62
DHM3.5	416	DRC6	422	DXC2.5	420	EAC419	52	EC12	269	EC500BN	62
DHM4	416	DRD25	419	DXC3.0	420	EB149	85	EC13	42, 353	EC500RE	62
DHM4.2	416	DRK8	421	DXC3.2	420	EB150	85	EC14	42, 353	EC600BK	62
DHM4.5	416	DRK19	418	DXC3.3	420	EB207	85	EC15	42, 80	EC600BN	62
DHM4.8	416	DRK25	419	DXC3.5	420	EB209	85	EC24	269	EC600RE	62
DHM4.9	416	DRM1	418	DXC4.0	420	EB233	85	EC49	65	EC702	62
DHM5	416	DRM1.5	418	DXC4.5	420	EB239	85	EC50	65	EC703	62
DHM5.5	416	DRM2	418	DXC5.0	420	EB241	84	EC51	65	EC712	62
DHM6	416	DRM2.5	418	DXC5.5	420	EB242	85	EC52	65	EC713	62
DHM6.5	416	DRM3	418	DXC6.0	420	EB245	85	EC53	65	EC801	63
DHM6.8	416	DRM3.2	418	DXC6.5	420	EB249	85	EC54	65	EC801RE	63
DHM7	416	DRM3.3	418	DXC8.0	420	EB264	85	EC55	65	EC802	63
DHM7.5	416	DRM3.5	418	DXM1	417	EB269	85	EC56	65	EC802RE	63
DHM8	416	DRM4	418	DXM1.5	417	EB286	85	EC57	65	EC803	63
DHM8.5	416	DRM4.5	418	DXM2	417	EB334	84	EC60	45	EC803RE	63
DHM9	416	DRM4.8	418	DXM2.5	417	EB346	84	EC61	45	EC900	62
DHM9.5	416	DRM5	418	DXM3	417	EB380	84	EC62	45	EC901	62
DHM10	416	DRM5.5	418	DXM3.2	417	EB382	84	EC63	43-44	EC902	62
DHM10.2	416	DRM6	418	DXM3.3	417	EB448	82	EC64	43-44	EC903	62
DHM10.5	416	DRM6.5	418	DXM3.5	417	EB453	82	EC65	43-44	EC904	62
DHM11	416	DRM7	418	DXM4	417	EB460	82	EC66	43-44	EC1102	63
DHM11.5	416	DRM7.5	418	DXM4.2	417	EB466	82	EC67	44	EC1104	63
DHM12	416	DRM8	418	DXM4.5	417	EB472	83	EC68	44	EC1201	63
DHM12.5	416	DRM8.5	418	DXM4.8	417	EB474	82	EC69	45	EC1202	63
DHM13	416	DRM9	418	DXM4.9	417	EB475	83	EC70	43	EC1204	63
DKEY2	422	DRM9.5	418	DXM5	417	EB477	82	EC71	43	EC1205	63
DKEY3	422	DRM10	418	DXM5.5	417	EB501	84	EC71A	43	EC1207	63
DPD11	406	DRM10.5	418	DXM6	417	EB501A	84	EC72	43	EC1211	63
DPD12	406	DRM11	418	DXM6.5	417	EB507	84	EC73	43	EC1221	63
DPD13	406	DRM11.5	418	DXM6.8	417	EB508	85	EC74	43	EC1222	63
DPD14	407	DRM12	418	DXM7	417	EB566	84	EC74A	43	EC1223	63
DPMK5	421	DRM12.5	418	DXM7.5	417	EB581	84	EC75	43	EC1231	63
DPW21	407	DRM13	418	DXM8	417	EB9005	82	EC75A	43	EC1232	63
DPW22	407	DRP1	393	DXM8.5	417	EB9006	82	EC76	43	EC1233	63
DPW31	407	DRS14	421	DXM9	417	EB85122	83	EC76A	43	EC1234	63
DPW32	407	DRS15	421	DXM9.5	417	EB85402	83	EC77	43	EC2000BK	61
DR12	418	DRS16	421	DXM10	417	EBC101	78, 280	EC78	43	EC2000BN	61
DR14	418	DRS18	421	DXM10.2	417	EBC102	78, 280	EC78A	43	EC2000BU	61
DR14L	418	DRS19	421	DXM10.5	417	EBC103	78, 280	EC80	43	EC2000GR	61





EFX225	46	EMC9	52	ER410	93	ERB501	98	ERP51	64	ERW380LED	96
EFX230	46	EMC9BK	52	ER429	93	ERB501A	98	ERP52	64	ERW382LED	95
EFX305	46	EMH250	80, 279	ER434	99	ERB504	98	ERP54	64	ERW477FLED	90
EFX307	46	EMH400	80, 279	ER435	99	ERB505	98	ERP55	64	ERW501CBLED	98
EFX310	46	EMH1000	80, 279	ER442	90	ERB507	98	ERP56	64	ERW1511	93
EFX315	46	EP209	89	ER443	90	ERB508	101	ERP57	64	ERW1548	91
EFX320	46	EP269	89	ER448	91	ERB508T	101	ERP62	65	ERW1572	91
EFX325	46	EP286T	89	ER448EQ	91	ERB566	96	ERP63	65	ERW1577	90
EFX330	46	EP335	88	ER453	90	ERB580	96	ERP68	65	ERW2336FSLED	99
EG1	37	EP339	88	ER460	90	ERB582	95	ERP68A	65	ERW2394LED	100
EG2	37	EP346	88	ER466	91	ERB581	95	ERP69	65	ERW2396FSLED	100
EG3	37	EPG13	53	ER470	99	ERB585	95	ERP69A	65	ERW2396LED	100
EG4	37	EPG16	53	ER472	91	ERB955	96	ERP71	64	ERW5014LED	98
EG5	37	EPG21	53	ER473	91	ERB1496LED	97	ERP74	64	ERW5016FSLED	98
EG6	37	EPG29	53	ER474	90	ERB2416LED	95	ERP76	65	ERW5016LED	98
EG7	37	EPG36	53	ER475	91	ERB5076FSLED	98	ERP77	65	ERW23912LED	100
EG8	37	EPG42	53	ER477	90	ERB5076LED	98	ERP78	65	ERW50112LED	98
EG9	37	EPT1	39, 323	ER501	98	ERBA50	106	ERP79	65	ERWL10	76
EG28	37	EPT2	39, 323	ER501A	98	ERCB116	67	ERP80	65	ERWL50	76
EG29	37	EPT3	39, 323	ER504	98	ERCB120	67	ERP81	65	ESL1	35
EG30	37	EPT4	39	ER505	98	ERCB125	67	ERP82	66	ESL2	35
EG31	37	EPT5	38	ER507	98	ERCB132	67	ERP83	66	ESL5	35
EG32	37	EPT6	39	ER508	101	ERCB316	67	ERP84	66	ESL6	35
EG33	37	EPT7	39, 323	ER508T	101	ERCB320	67	ERP85	66	ESL51	35
EG34	37	EPT11	39, 323	ER508TCWH	101	ERCB325	67	ERP86	66	ESL52	35
EG35	37	EPT12	39, 323	ER509T	101	ERCB332	67	ERP88	66	ET1	31
EG36	37	EPT13	39, 323	ER535	99	ERCB340	67	ERP89	66	ET2	31
EG37	37	EPT14	39, 323	ER566	96	ERCB350	67	ERP90	66	ET3	28
EG38	37	EPT15	39, 323	ER567	96	ERCB363	67	ERP102	66	ET4	28
EH1	81	EPT16	39, 323	ER570	99	ERCD243	67	ERP103	66	ET5	29
EH2	81	EPT17	39, 323	ER571	99	ERCD253	67	ERP104	66	ET6	28
EH3	81	EPT18	39, 323	ER580	96	ERCD413	67	ERP105	66	ET7	29
EH4	81	EPT21	39, 323	ER581	95	ERCD425	67	ERP106	66	ET8	30
EHL12	80	EPT74	39, 323	ER582	95	ERCD443	67	ERP107	66	ET9	28
EHL29	80	ER12	92	ER585	95	ERCD463	67	ERP108	66	ET10	29
EHL30	80	ER24	92	ER588	95	ERCD633	67	ERP109	66	ET10K	29
EHL55	80	ER149	97	ER708	92	ERCT816P	274, 276	ERP110	66	ET11	30
EHL300B	74	ER150	96	ER709	93	ERCT830P	274, 276	ERP111	66	ET12	30
EHL300LR	74	ER180	97	ER711	93	ERCT900P	274, 276	ERP112	66	ET13	30
EHL300LY	74	ER207	97	ER874	97	ERCV5012	80, 279	ERP113	66	ET14	29
EHL300R	74	ER209	96	ER875	96	ERCV5013	80, 279	ERP116	274	ET15	28
EHL305	74	ER233	99	ER921	96	ERCV9420		ERP117	274	ET16	29
EHL640	80	ER239	100	ER955	96		78-79, 280-281	ERP125	65	ET17	30
EHL805	81	ER241	95	ER987	97	ERCV9607	77, 278	ERP150	65	ET18	28
EHL810	81	ER242	100	ER1471	101	ERCV9608	77, 278	ERPB121	101	ET19	29
EHL1000	74	ER245	97	ER1791	101	ERCV9761	79, 281	ERPB122	101	ET20	28
EHL1002	74	ER246	97	ER2401LED	101	ERCV9822	79, 281	ERPB243	101	ET21	29
EHLED4	81	ER247	96	ER8328	101	ERDCP20	68	ERPPL300	106	ET22	28
EHLED4A	81	ER248	97	ER9005	92	ERIL56	73	ERPPL700	107	ET23	29
EHLED6	81	ER249	99	ER9006	92	ERIL58	73	ERPPS3000A	107	ET24	30
EHLED6A	81	ER260	100	ER85126	94	ERIL4200	75	ERPPS4000A	107	ET25	28
EHLF2R	76	ER264	100	ER85402	94	ERIL4300	75	ERSC704	105	ET26	29
EHLF3R	76	ER265	100	ERAC630	234	ERINV120	104	ERSC808	105	ET27	30
EHS13	38	ER269	100	ERAC700	234	ERINVMA10	104	ERSCPR50	105	ET28	28
EHS13RE	38	ER272	100	ERAC820	235	ERINVMA20	104	ERSD125	67	ET29	29
EHS14	38	ER273	100	ERAC900	234	ERINVU300	104	ERSD140	67	ET30	30
EHS14RE	38	ER274	100	ERB149	97	ERINVU500	104	ERSD163	67	ET31	29
EHS41	38	ER281	99	ERB150	96	ERL1	41	ERSD310	67	ET32	30
EHS41RE	38	ER283	99	ERB207S	97	ERL4	41	ERSD340	67	ET33	28
EHS42	38	ER286	101	ERB209	96	ERL5	41	ERSD363	67	ET33K	28
EHS42RE	38	ER286B	101	ERB233	99	ERL6	41	ERSD380	67	ET34	29
EHS43	38	ER289	99	ERB239	100	ERL7	41	ERSD410	67	ET34K	29
EHS43RE	38	ER290	95	ERB241	95	ERL11	41	ERSR230	66	ET35	30
EHS44	38	ER291	95	ERB242	100	ERL100	41	ERST230	66	ET36	28
EHS44RE	38	ER294	96	ERB245S	97	ERLD1	299	ERT5174	70	ET37	29
EHS45	38	ER295	97	ERB246	97	ERLD2	299	ERT5191	70	ET37K	29
EHS45RE	38	ER296	99	ERB249	99	ERLD4	299	ERT5210	70	ET38	30
EHS61	38	ER334	96	ERB264	100	ERMM500	482	ERTC2000	235	ET39	31
EHS62	38	ER335	95	ERB269	100	ERP13	274	ERTC6000	235	ET41	31
EHS63	38	ER339	95	ERB272	100	ERP14	274	ERU126	102	ET42	29
EHS64	38	ER343	95	ERB286	101	ERP18	64	ERU175	103	ET43	30
ELED501RES	98	ER345	95	ERB294	96	ERP20	64	ERU280	103	ET44	28
EM1	267	ER346	95	ERB335	95	ERP25	64	ERU194	103	ET45	28
EM3	267	ER380	96	ERB343	95	ERP41	274	ERVEP1	68	ET46	29
EM4	267	ER381	97	ERB346	95	ERP42	274	ERVEP2	68	ET47	29
EMC5	52	ER382	95	ERB380	96	ERP42A	274	ERW207LED	97	ET48	28
EMCSBK	52	ER395	94	ERB382	95	ERP50	64	ERW239CBLED	100	ET49	30





FIX365	194	FIX461	175, 195, 197	FIX602	188	FIX720	146, 187, 193	FIX831	176, 186, 190-191	GAS63	128, 397
FIX366	175	FIX462	179, 197	FIX603	193	FIX721	147	FIX833	192	GAS64	397
FIX367	194	FIX463	162, 192	FIX604	196	FIX722	149, 187	FIX835	176, 194	GAS71	397
FIX368	197	FIX464	192	FIX605	191	FIX724	147, 193	FIX837	179, 197	GAS72	397
FIX369	182	FIX465	192	FIX606	195	FIX725	146	FIX838	176, 197-198	GAS73	397
FIX370	195	FIX466	197	FIX607	186	FIX726	146, 191	FIX841	176, 190-191, 194-195	GAS74	397
FIX371	195	FIX467	192	FIX608	186	FIX728	146	FIX843	192	GAS75	397
FIX373	194	FIX468	186	FIX609	194	FIX729	146, 196	FIX845	176, 193, 196-197	GLU4	332
FIX374	194	FIX472	194	FIX611	194	FIX730	147	FIX846	176, 185, 192	GLU4A	332
FIX375	190	FIX473	192	FIX613	162, 186	FIX731	147	FIX848	177, 194	GLU5	323, 335
FIX377	194	FIX474	186	FIX614	186	FIX732	147, 191	FIX850	179, 193	GLU10	320
FIX378	199	FIX475	187	FIX616	188	FIX733	146, 191, 195	FIX851	191	GLU11	320
FIX379	199	FIX476	191	FIX617	188	FIX734	146, 191	FIX853	176, 194	GLU12	332
FIX380	162, 190	FIX477	182, 197	FIX618	188	FIX735	147	FIX854	196	GLU12A	332
FIX382	182, 197	FIX478	186, 194	FIX619	188	FIX736	147	FIX856	176, 196, 199	GLU13	258, 288
FIX383	188	FIX479	194	FIX620	195	FIX737	147	FIX857	186	GLU21	320
FIX384	181, 191	FIX480	194	FIX621	175, 191, 195, 197	FIX738	147	FIX858	194	GLU24	320
FIX385	194	FIX481	175, 188	FIX622	197	FIX740	174, 190	FIX859	57, 183	GLU51	323, 335
FIX386	194	FIX482	175, 188	FIX623	191	FIX742	186, 190	FIX860	194	GN1	302
FIX387	189	FIX483	175, 188	FIX624	182	FIX743	190	FIX861	178, 191	GN2	302
FIX388	192	FIX484	187	FIX628	195	FIX746	175, 196	FIX862	150	GN3	302
FIX390	190	FIX485	188	FIX629	197	FIX747	174, 195, 197	FIX863	176, 198-199	GN4	302
FIX391	188	FIX486	192	FIX630	150, 186	FIX749	174, 197, 199	FIX865	162	GN5	302
FIX392	196	FIX487	192	FIX631	187	FIX751	167, 187-188, 190-191, 193, 196, 198	FIX866	187	GN6	302
FIX394	196	FIX489	192	FIX632	188	FIX753	166, 192	FIX867	175, 189, 196	GN7	302
FIX396	196	FIX490	181, 185	FIX633	191	FIX754	167, 195, 199	FIX868	193	GN8	302
FIX397	196	FIX493	194	FIX634	180, 194	FIX756	167, 191	FIX869	180	GN9	302
FIX400	179, 186	FIX494	186	FIX635	194	FIX758	166, 192, 195, 197, 199	FIX871	192	GN10	302
FIX401	186	FIX495	178, 196	FIX637	166, 197	FIX759	165, 194	FIX872	163, 192, 197	GN11	302
FIX403	167, 190	FIX496	196, 198	FIX638	187	FIX760	165, 189, 195	FIX877	192	GN12	302
FIX404	188	FIX497	188	FIX639	181, 188	FIX762	199	FIX878	188	GN13	302
FIX406	196	FIX499	162, 193	FIX640	181, 188	FIX763	167, 197	FIX880	176, 196	GN14	302
FIX407	181, 197	FIX500	163, 188-190	FIX641	195	FIX764	166, 197	FIX883	193	GN15	302
FIX409	149, 190	FIX501	163, 189	FIX642	194	FIX765	166, 192	FIX886	178, 193	GN16	302
FIX411	180, 187	FIX502	163, 192	FIX644	186	FIX766	165, 195, 197	FIX888	186, 189	GN17	302
FIX413	186	FIX503	163, 187-188, 190, 198	FIX645	175, 192	FIX768	167, 195	FIX890	175, 188, 193	GN19	302
FIX414	165, 194	FIX504	164	FIX648	196	FIX769	166, 192	FIX891	166, 189-190, 198	GN20	303
FIX415	188	FIX505	164, 190	FIX650	186	FIX771	167, 197	FIX892	185	GN22	302
FIX416	188	FIX506	167, 188, 194-195, 199	FIX651	167, 195	FIX772	167, 196	FIX1013	183	GN23	303
FIX417	180, 188, 190, 198	FIX507	167, 195, 197	FIX652	148, 193	FIX774	165	FIX1421	183	GN31	302
FIX418	186	FIX508	166, 189	FIX653	148	FIX775	165, 197	FIX2230	183	GN33	302
FIX419	188	FIX509	167	FIX657	193	FIX776	165, 195, 197, 199	FUN1	359	GN34	302
FIX420	194	FIX510	165, 195-197, 199	FIX660	149, 194	FIX778	188	FUN2	359	GN35	302
FIX421	175, 185	FIX511	166, 197	FIX661	149, 194	FIX779	167, 194	FUN3	359	GN36	302
FIX422	186	FIX512	165, 195	FIX662	196	FIX780	165, 187	FUN5	359	GN37	302
FIX423	188	FIX513	166, 188, 191, 193, 195, 199	FIX664	190	FIX781	165, 195, 197, 199	FUN6	359	GN51	303
FIX424	180, 194	FIX514	166, 192	FIX668	164, 190	FIX785	192	FUN7	359	GN52	303
FIX425	194	FIX515	168, 186-189, 193, 196	FIX669	164, 190	FIX786	165, 196	FUN50	359	GN191	302
FIX426	194	FIX516	169, 194, 199	FIX672	163	FIX791	188	FUN60	359	GN192	302
FIX427	194	FIX517	169, 185, 187, 189, 191, 193, 198-199	FIX673	199	FIX792	171, 186	G		GT5	258
FIX428	194	FIX518	170, 191	FIX674	199	FIX793	171, 186	GAS3	396	GT6	258
FIX429	194	FIX519	171, 192	FIX675	199	FIX794	170, 195, 199	GAS4	396	GT14	258
FIX430	194	FIX520	171, 192-193	FIX677	163, 199	FIX795	171, 191-193, 195	GAS5	396	GT18	258
FIX431	194	FIX521	172, 192-193, 199	FIX680	199	FIX796	170, 191-193	GAS6	396	H	
FIX432	194	FIX522	170, 191, 193, 195, 197, 199	FIX682	163, 199	FIX797	172	GAS7	396	HAC200	11, 135
FIX433	196	FIX523	171, 193, 195	FIX684	199	FIX798	172, 185-186	GAS8	397	HAW610	133
FIX434	181, 186	FIX524	174, 185, 189-190	FIX687	164	FIX800	192	GAS9	397	HAW811	133
FIX435	186	FIX525	174, 197	FIX688	199	FIX801	170, 193, 195	GAS20	396	HAW1013	133
FIX436	181, 185	FIX526	174, 197	FIX689	199	FIX802	172, 194	GAS21	396	HAW1014	133
FIX438	189	FIX527	176, 190, 197-199	FIX690	189, 191	FIX804	171, 194	GAS22	396	HAW1216	133
FIX439	188	FIX528	177, 187-188	FIX693	164	FIX806	170, 189, 196	GAS23	396	HAW1218	133
FIX440	162, 190, 196	FIX529	176, 186, 189, 196	FIX696	190	FIX807	170, 192	GAS24	396	HAW1418	133
FIX442	194	FIX530	177, 197	FIX699	190	FIX810	176, 191, 198	GAS25	392, 396	HAW1420	133
FIX445	188	FIX531	177, 197, 199	FIX700	192	FIX812	177, 188	GAS26	392, 396	HAW1620	133
FIX446	187, 190	FIX532	179, 189-190, 196	FIX701	192	FIX814	189	GAS30	396	HAW1721	133
FIX447	187	FIX533	178, 190, 196, 198-199	FIX703	164, 187, 198	FIX818	176	GAS32	396	HAW2227	133
FIX448	189	FIX534	179, 189-190	FIX705	164, 198	FIX821	178, 193	GAS35	397	HBA1	123
FIX449	162, 191	FIX535	179, 192	FIX707	192, 196	FIX822	179, 193	GAS36	397	HBA3	123
FIX451	194	FIX600	194	FIX709	169, 199	FIX824	177, 190	GAS37	397	HBA4	123
FIX452	185	FIX601	194	FIX710	193, 198-199	FIX827	190-191	GAS38	397	HBA5	123
FIX453	149, 187-188			FIX712	184, 189	FIX828	176, 196	GAS39	397	HBA6	123
FIX455	187			FIX714	146, 187	FIX829	196	GAS40	397	HBA7	123
FIX456	186			FIX715	146			GAS60	397	HBA8	123
FIX457	186			FIX716	146, 186-187, 189			GAS61	397	HBA9	123
FIX458	182, 192, 197			FIX718	198			GAS62	397	HBA10	123
FIX459	197			FIX719	146, 192						
FIX460	162, 192										





HBA11	123	HBO61	117	HBS440	123	HCH56	120	HCH1650	120	HCS16	118
HBA12	123	HBO62	117	HBS512	123	HCH310	120	HCH1665	120	HCS17	118
HBA13	123	HBO63	117	HBS516	123	HCH312	120	HCH1680	120	HCS18	118
HBA14	123	HBO64	117	HBS525	123	HCH320	120	HCH1690	120	HCS19	118
HBA15	123	HBO65	117	HBS540	123	HCH330	120	HCH2050	120	HCS20	118
HBA16	123	HBO66	117	HBS550	123	HCH335	120	HCH2080	120	HCS21	118
HBA17	123	HBO67	117	HBS625	123	HCH410	120	HCH2090	120	HCS22	118
HBC520	124	HBO68	117	HBS640	123	HCH412	120	HCH2490	120	HCS23	118
HBC525	124	HBO70	117	HBS650	123	HCH416	120	HCH10100	120	HCS24	118
HBC550	124	HBO71	117	HBT510	123	HCH420	120	HCH12130	120	HCS25	118
HBC610	124	HBO72	117	HBT516	123	HCH425	120	HCH16100	120	HCS26	118
HBC620	124	HBO73	117	HBT525	123	HCH430	120	HCH16200	120	HCS27	118
HBC612	124	HBO74	117	HBT550	123	HCH440	120	HCH20100	120	HCS28	118
HBC625	124	HBO75	117	HBT625	123	HCH450	120	HCH20140	120	HCS29	118
HBC650	124	HBO76	117	HBT650	123	HCH510	120	HCH20150	120	HCS30	118
HBC820	124	HBO77	117	HBU410	121	HCH512	120	HCH24100	120	HCS31	118
HBC825	124	HBO78	117	HBU512	121	HCH516	120	HCL111	156	HCS32	118
HBH306	122	HBO79	117	HBU516	121	HCH520	120	HCL113	156	HCS33	118
HBH308	122	HBO80	117	HBU520	121	HCH525	120	HCL116	156	HCS34	118
HBH310	122	HBO81	117	HBU525	121	HCH530	120	HCL119	156	HCS35	118
HBH312	122	HBO82	117	HBU610	121	HCH540	120	HCL121	156	HCS36	118
HBH320	122	HBO83	117	HBU612	121	HCH550	120	HCL122	156	HCS37	118
HBH325	122	HBO84	117	HBU616	121	HCH580	120	HCL125	156	HCS38	118
HBH330	122	HBO85	117	HBU625	121	HCH610	120	HCL130	156	HCS39	118
HBH350	122	HBO86	117	HBU630	121	HCH612	120	HCL135	156	HCS40	118
HBH406	122	HBO87	117	HBU810	121	HCH615	120	HCL138	156	HCS41	118
HBH412	122	HBO88	117	HBU816	121	HCH616	120	HCL140	156	HCS42	118
HBH508	122	HBO89	117	HBU820	121	HCH620	120	HCL142	156	HCS43	118
HBH510	122	HBO90	117	HBU825	121	HCH625	120	HCL147	156	HCS44	118
HBH516	122	HBO91	117	HBU830	121	HCH630	120	HCL207	156	HCS45	118
HBH550	122	HBO92	117	HBU1040	121	HCH635	120	HCL208	156	HCS46	118
HBH610	122	HBO93	117	HBZ620	121	HCH640	120	HCL210	156	HCT8	144
HBH612	122	HBO94	117	HBZ820	121	HCH645	120	HCL211	156	HCT10	118
HBH616	122	HBO95	117	HBZ830	121	HCH650	120	HCL212	156	HCT12	118
HBH620	122	HBO96	117	HBZ840	121	HCH660	120	HCL213	156	HCU23	134
HBH625	122	HBO97	117	HBZ1030	121	HCH665	120	HCL214	156	HCU24	134
HBN5	119, 129, 267	HBO98	117	HBZ1035	121	HCH670	120	HCL215	156	HCU25	134
HBN6	119, 129, 267	HBO99	117	HBZ1040	121	HCH810	120	HCL216	156	HCU34	134
HBN7	119, 129, 267	HBO100	117	HCO	205	HCH812	120	HCL217	156	HCU35	134
HBN8	119, 129, 267	HBO101	117	HCO0	205	HCH816	120	HCL218	156	HCU46	134
HBN10	119, 129, 267	HBO102	117	HCO00	205	HCH820	120	HCL219	156	HCU48	134
HBNA0	128	HBO103	117	HCOX	205	HCH825	120	HCL220	156	HCU57	134
HBNA1	128	HBO104	117	HC1	205	HCH830	120	HCL221	156	HCU58	134
HBNA2	128	HBO105	117	HC1A	205	HCH835	120	HCL222	156	HCU68	134
HBO2	117	HBO106	117	HC1X	205	HCH840	120	HCL224	156	HCU80	134
HBO3	117	HBO107	117	HC2	205	HCH845	120	HCL225	156	HCU81	134
HBO4	117	HBO108	117	HC2A	205	HCH850	120	HCL230	156	HCU91	134
HBO5	117	HBO109	117	HC2X	205	HCH860	120	HCL235	156	HCU93	134
HBO6	117	HBO110	117	HC3	205	HCH865	120	HCL238	156	HCU95	134
HBO7	117	HBO111	117	HC3X	205	HCH870	120	HCL240	156	HCU96	134
HBO8	117	HBO112	117	HC4	205	HCH890	120	HCL250	156	HCU509	134
HBO9	117	HBO113	117	HC4X	205	HCH1020	120	HCM00	205	HCU609	134
HBO10	117	HBO114	117	HCA8	203	HCH1025	120	HCN61	151	HCU610	134
HBO11	117	HBP68	124	HCA9	203	HCH1030	120	HCN62	151	HCU612	134
HBO12	117	HBP312	124	HCA10	203	HCH1035	120	HCP1	157	HCU811	134
HBO13	117	HBP330	124	HCA11	203	HCH1040	120	HCP2	157	HCU812	134
HBO14	117	HBP412	124	HCA12	203	HCH1045	120	HCP3	157	HCU814	134
HBO15	117	HBP435	124	HCA13	203	HCH1050	120	HCP4	157	HCU914	134
HBO16	117	HBP450	124	HCA14	203	HCH1055	120	HCP5	157	HCU1013	134
HBO17	117	HBP516	124	HCA15	203	HCH1060	120	HCP6	157	HCU1014	134
HBO21	117	HBP520	124	HCA16	203	HCH1070	120	HCP7	157	HCU1016	134
HBO22	117	HBP525	124	HCA17	203	HCH1075	120	HCP8	157	HCU1021	134
HBO23	117	HBP540	124	HCB1	118	HCH1080	120	HCS1	118	HCU1117	134
HBO24	117	HBP550	124	HCB2	118	HCH1090	120	HCS2	118	HCU1216	134
HBO25	117	HBP610	124	HCB3	118	HCH1220	120	HCS3	118	HCU1218	134
HBO26	117	HBP616	124	HCB4	118	HCH1225	120	HCS4	118	HCU1318	134
HBO27	117	HBP620	124	HCB5	118	HCH1230	120	HCS5	118	HCU1418	134
HBO28	117	HBP625	124	HCB6	118	HCH1235	120	HCS6	118	HCU1420	134
HBO29	117	HBP820	124	HCC610	133, 135	HCH1240	120	HCS7	118	HCU1520	134
HBO30	117	HBP825	124	HCC812	133, 135	HCH1245	120	HCS8	118	HCU1620	134
HBO31	117	HBS36	123	HCC1014	133, 135	HCH1250	120	HCS9	118	HCU1622	134
HBO32	117	HBS48	123	HCC1218	133, 135	HCH1260	120	HCS10	118	HCU1624	134
HBO33	117	HBS320	123	HCC2026	133, 135	HCH1275	120	HCS11	118	HCU1721	134
HBO34	117	HBS325	123	HCC2227	133, 135	HCH1280	120	HCS12	118	HCU1723	134
HBO35	117	HBS340	123	HCC2632	133, 135	HCH1290	120	HCS13	118	HCU1725	134
HBO36	117	HBS416	123	HCD100	205	HCH1630	120	HCS14	118	HCU1822	134
HBO37	117	HBS425	123	HCH38	120	HCH1640	120	HCS15	118	HCU1824	134

HCU2024	134	HFB6	133	HFW66	130	HKB1675	122	HRF620	118	HSN23	126
HCU2026	134	HFB8	133	HFW67	130	HKB20100	122	HRF625	118	HSN24	126
HCU2125	134	HFB10	133	HH1	216	HKZ460	122	HRF640	118	HSN25	126
HCU2227	134	HFB12	133	HH2	216	HKZ620	122	HRF650	118	HSN26	126
HCU2430	134	HFB14	133	HH3	216	HKZ640	122	HRF660	118	HSN27	126
HCU2634	134	HFB16	133	HH4	216	HKZ825	122	HRF680	118	HSN28	126
HCU2834	134	HFB18	133	HHD8/4	145	HKZ830	122	HRF830	118	HSN29	126
HCU3038	134	HFB31	133	HHD8/6	145	HLW1	132	HRF835	118	HSN30	126
HCU3240	134	HFB32	133	HHD8/8	145	HLW2	132	HRF860	118	HSN31	126
HCU3545	134	HFB33	133	HHD10/4	145	HLW3	132	HRF880	118	HSN32	126
HCU10165	134	HFB34	133	HHD10/6	145	HLW4	132	HRF6100	118	HSN33	126
HCU14180	134	HFB35	133	HHD10/8	145	HLW5	132	HRK105	124, 423	HSN34	126
HCV1	56, 203, 250	HFB36	133	HHD12/8	145	HLW6	132	HRK106	124, 423	HSN35	126
HCV2	56, 203, 250	HFB37	133	HHD12/12	145	HLW20	132	HRK108	124, 423	HSN36	126
HCW5	132	HFB38	133	HHD12/16	145	HLW21	132	HRK110	124, 423	HSN37	126
HCW6	132	HFC1	150	HHD14/8	145	HLW22	132	HRK112	124, 423	HSN38	126
HCW8	132	HFC2	150	HHD14/12	145	HLW23	132	HRK214	124, 423	HSN40	128
HCW10	132	HFC6	150	HHD14/16	145	HLW24	132	HRP105	124, 423	HSN41	128
HCW11	132	HFC7	150	HIL105	127	HLW27	132	HRP106	124, 423	HSN42	128
HCW12	132	HFC8	150	HIL106	127	HLW28	132	HRP108	124, 423	HSN55	128
HCZ1	121	HFC9	150	HIL108	127	HLW29	132	HRP110	124, 423	HSN56	128
HCZ2	121	HFC10	150	HIL110	127	HMB623	153	HRP112	124, 423	HSN58	128
HCZ3	121	HFC11	150	HIN105	126	HMB632	153	HRP208	124, 423	HSN60	128
HCZ4	121	HFC12	150	HIN106	126	HMS11	119, 267	HRP212	124, 423	HSN62	128
HCZ5	121	HFL125	116	HIN108	126	HMS12	119, 267	HRW1	129	HSN64	128
HCZ6	121	HFL130	116	HIN110	126	HMS13	119, 267	HRW2	129	HSN66	128
HCZ7	121	HFL140	116	HIP105	131	HMS14	119, 267	HRW3	129	HSN78	128
HCZ8	121	HFL150	116	HIP106	131	HMS15	119, 267	HRW4	129	HSN78	128
HCZ9	121	HFL616	116	HIP108	131	HMS16	119, 267	HRW5	129	HSP1	158
HCZ10	121	HFL620	116	HIP110	131	HN0816	206	HRW6	129	HSP2	158
HCZ11	121	HFL625	116	HIS525	115	HN1220	206	HRW7	129	HSP3	158
HCZ308	121	HFL630	116	HIS625	115	HN1625	206	HRW8	129	HSP4	158
HCZ316	121	HFL820	116	HIS825	115	HN2032	206	HRW13	129	HSP5	158
HCZ420	121	HFL825	116	HIS840	115	HN2840	206	HRW14	129	HSP6	158
HCZ430	121	HFL830	116	HIS1025	115	HN3250	206	HRW15	129	HSP7	158
HCZ510	121	HFL840	116	HIS1040	115	HN4060	206	HRW520	129	HSP8	158
HCZ516	121	HFV1	130	HIW105	131	HN5070	206	HRW620	129	HSP9	158
HCZ525	121	HFV2	130	HIW106	131	HNG6080	206	HRW830	129	HSP10	158
HCZ530	121	HFV3	130	HIW108	131	HN7090	206	HRW1025	129	HSP11	158
HCZ535	121	HFV4	130	HIW110	131	HN80100	206	HRW1040	129	HSP12	158
HCZ540	121	HFV5	130	HJC1	148	HNN1	127	HSB510	115	HSP13	159
HCZ620	121	HFV6	130	HJC2	148	HNN2	127	HSB670	115	HSP19	159
HCZ625	121	HFV7	130	HJC3	148	HNN3	127	HSB880	115	HSP20	158
HCZ630	121	HFV8	130	HJC4	148	HNN4	127	HSB1220	115	HSP21	159
HCZ635	121	HFV10	130	HKB36	122	HNN5	127	HSB1265	115	HSP22	159
HCZ816	121	HFV11	130	HKB320	122	HNN6	127	HSB1280	115	HSP33	159
HCZ820	121	HFV12	130	HKB412	122	HNN9	127	HSB1640	115	HSP62	159
HCZ830	121	HFV13	130	HKB416	122	HNN20	127	HSB1660	115	HSP63	159
HCZ845	121	HFV14	130	HKB420	122	HNN21	127	HSB1680	115	HSR26	119
HCZ865	121	HFV15	130	HKB440	122	HNN22	127	HSB12120	115	HSR28	119
HCZ1025	121	HFV16	130	HKB510	122	HNN23	127	HSL10	135	HSR30	119
HCZ1030	121	HFV17	130	HKB512	122	HNN24	127	HSL12	135	HSR32	119
HCZ1040	121	HFV18	130	HKB516	122	HNN25	127	HSL14	135	HSR34	119
HCZ1225	121	HFV19	130	HKB520	122	HNN26	127	HSL16	135	HSR36	119
HCZ1660	121	HFV20	130	HKB525	122	HNN27	127	HSL18	135	HSR38	119
HCZ10130	121	HFV40	130	HKB530	122	HNN32	127	HSL20	135	HSR40	119
HCZ12100	121	HFV41	130	HKB612	122	HNN33	127	HSL22	135	HSS2	116
HCZ12110	121	HFV42	130	HKB616	122	HNN34	127	HSL24	135	HSS3	116
HER1	157	HFV43	130	HKB620	122	HNN35	127	HSL41	135	HSS5	116
HER2	157	HFV44	130	HKB625	122	HNN36	127	HSL42	135	HSS6	116
HER3	157	HFV45	130	HKB630	122	HNU108	128	HSL43	135	HSS7	116
HER4	157	HFV46	130	HKB640	122	HNU110	128	HSL44	135	HSS8	116
HER6	157	HFV47	130	HKB820	122	HNU112	128	HSL45	135	HSS9	116
HER7	157	HFV48	130	HKB825	122	HNU114	128	HSL46	135	HSS10	116
HER13	157	HFV49	130	HKB830	122	HNU116	128	HSL48	135	HSS11	116
HER15	157	HFV50	130	HKB840	122	HPD6/4	145	HSN1	126	HSS12	116
HER51	157	HFV51	130	HKB850	122	HPD6/6	145	HSN2	126	HSS13	116
HER52	157	HFV52	130	HKB860	122	HPD6/8	145	HSN3	126	HSS14	116
HER53	157	HFV53	130	HKB1020	122	HPD8/4	145	HSN4	126	HSS15	116
HER54	157	HFV54	130	HKB1025	122	HPD8/6	145	HSN5	126	HSS16	116
HER55	157	HFV59	130	HKB1035	122	HPD8/8	145	HSN6	126	HSS17	116
HER56	157	HFV60	130	HKB1040	122	HPD10/4	145	HSN7	126	HSS18	116
HER57	157	HFV61	130	HKB1050	122	HPD10/6	145	HSN8	126	HSS19	116
HER58	157	HFV62	130	HKB1225	122	HPD10/8	145	HSN19	126	HSS20	116
HER59	157	HFV63	130	HKB1250	122	HPD10/12	145	HSN20	126	HSS36	114
HER60	157	HFV64	130	HKB1650	122	HPD10/16	145	HSN21	126	HSS37	114
HFBS	133	HFV65	130	HKB1670	122	HRF520	118	HSN22	126	HSS38	114





HSS39	114		262, 264
HSS40	114	HSU12	133, 135-136, 263-264
HSS41	114		263-264
HSS42	114	HSU14	136, 264
HSS43	114	HSU19	137, 265
HSS44	114	HSU20	137, 261, 265
HSS45	114	HSU21	137, 261-263, 265
HSS46	114	HSU25	137, 261, 265
HSS47	114	HSU26	136, 264
HSS48	114	HSU27	136, 264
HSS50	114	HSU30	137, 265
HSS51	114	HSU35	136, 264
HSS52	114	HSU40	137, 260, 265
HSS53	114	HSU41	137, 265
HSS54	114	HSU45	136, 260, 264
HSS55	114	HSU50	137, 261, 265
HSS56	114	HSU51	137, 262, 265
HSS57	114	HSU60	137, 260-261, 265
HSS58	114	HSU81	260
HSS60	114	HSU82	261
HSS61	114	HSU83	262
HSS62	114	HSU84	261
HSS64	114	HSU85	262
HSS65	114	HSU86	263
HSS66	114	HSU87	262
HSS69	114	HSU88	261
HSS70	114	HSU89	263
HSS71	114	HSU90	261
HSS72	114	HSU91	262
HSS73	114	HSU92	261
HSS74	114	HSU93	260
HSS75	114	HSU94	262
HSS76	114	HSU95	260
HSS77	114	HSU96	260
HSS78	114	HSU97	263
HSS79	114	HSU98	262
HSS80	116	HSU101	260
HSS81	116	HSU102	263
HSS82	116	HSU104	260
HSS83	116	HSU105	261
HSS84	116	HSU106	263
HSS85	116	HSU107	263
HSS86	116	HSU181	260
HSS87	116	HSU182	261
HSS88	116	HSU183	262
HSS89	116	HSU185	262
HSS90	116	HSU186	263
HSS91	116	HSU187	262
HSS92	114	HSU190	261
HSS93	114	HSU191	262
HSS94	114	HSU193	260
HSS95	114	HSU194	262
HSS96	114	HSU195	260
HSS97	114	HSU196	260
HSS98	114	HSU197	263
HSS99	114	HSU198	262
HSS100	114	HSU1022	136, 260, 264
HSS101	114	HSU1215	137, 260, 265
HSS102	114	HSU1217	136, 260, 264
HSS103	114	HSU1217AL	
HSS104	114		137, 260, 265
HSS105	114	HSU1824AL	
HSS106	114		137, 263, 265
HSS107	114	HSU1420	136, 262, 264
HSS108	114	HSU1826	136, 263-264
HSS109	114	HSUP1	259
HSS110	114	HSUP2	259
HSS111	114	HSUP3	259
HSS112	114	HSUP4	259
HSS113	114	HSW1	131
HSS114	114	HSW2	131
HSS115	114	HSW3	131
HSS116	114	HSW4	131
HSS117	114	HSW5	131
HSU10	133, 135-136, 261, 264	HSW6	131
HSU11	133, 135-136,	HSW8	131
		HSW9	131

HSW10	131	HTP8/6	142
HSW11	131	HTP8/8	142
HSW12	131	HTP8/12	142
HSW13	131	HTP10/4	142
HSW14	131	HTP10/5	142
HSW15	131	HTP10/6	142
HSW16	131	HTP10/8	142
HSW17	131	HTP10/10	142
HSW18	131	HTP10/12	142
HSW19	131	HTP12/4	142
HSW20	131	HTP12/6	142
HSW21	131	HTP12/8	142
HTA6/4	142	HTP12/12	142
HTA6/6	142	HTP12/16	142
HTA6/8	142	HTP12/24	142
HTA8/4	142	HTP14/6	142
HTA8/6	142	HTP14/8	142
HTA8/8	142	HTP14/12	142
HTA10/4	142	HTW6/6	143
HTA10/6	142	HTW6/8	143
HTA10/8	142	HTW6/10	143
HTC4/4	143	HTW6/12	143
HTC4/6	143	HTW8/4	143
HTC6/4	143	HTW8/6	143
HTC6/5	143	HTW8/10	143
HTC6/6	143	HTW8/12	143
HTC6/8	143	HTW8/14	143
HTC6/10	143	HTW8/16	143
HTC6/12	143	HTW8/20	143
HTC8/4	143	HTW8/24	143
HTC8/5	143	HTW10/8	143
HTC8/6	143	HTW10/12	143
HTC8/8	143	HTW10/16	143
HTC8/12	143	HTW10/20	143
HTC8/16	143	HTW10/24	143
HTC10/4	143	HTW12/8	143
HTC10/5	143	HTW12/12	143
HTC10/6	143	HTW12/24	143
HTC10/8	143	HUC1	148
HTC10/10	143	HUC2	148
HTC10/12	143	HUC3	148
HTC10/16	143	HUC4	148
HTC12/6	143	HUC5	148
HTC12/8	143	HUC6	148
HTC12/12	143	HUC7	148
HTC14/12	142	HUC11	148
HTC14/12A	143	HUC21	148
HTC14/14	142	HUC22	148
HTC14/14A	143	HUC50	149
HTC14/16	142	HUC51	149
HTC14/16A	143	HUC52	149
HTK6/3	144	HUC55	149
HTK6/4	144	HUC56	149
HTK6/5	144	HUC57	149
HTK6/6	144	HUC58	149
HTK6/8	144	HUC59	149
HTK8/3	144	HWN1	128
HTK8/4	144	HWN2	128
HTK8/5	144	HWN3	128
HTK8/6	144	HWN4	128
HTK8/8	144	HXT6/5	144
HTK8/10	144	HXT7/6	144
HTK8/12	144	HXT8/5	144
HTK10/3	144	HXT8/6	144
HTK10/4	144	HXT8/8	144
HTK10/5	144	HXT10/5	144
HTK10/6	144	HY10	284
HTK10/8	144	HY11	284
HTP4/4	142	HY12	284
HTP4/6	142	HY13	284
HTP6/4	142	HY14	218
HTP6/5	142	HY20	158, 271
HTP6/6	142	HY38	218
HTP6/8	142	HY38D	218
HTP6/10	142	HY100	283
HTP8/4	142	HY101	283
HTP8/5	142	HY102	283

HY103	283	JCS2A	202
HY110	283	JCS2X	202
HY111	283	JCS3	202
HY112	283	JCS3X	202
HY113	283	JCS4	202
HY114	283	JCS4X	202
HY115	283	JCS5	202
HY116	283	JCS6	202
HY117	283	JCS7	202
HY118	283	JCS24	202
HY119	283	JCS50	202
HY120	283	JCS100	202
HY121	283	JCS160	202
HY130	282	JCS245	202
HY131	282	JCSM00	202
HY132	282	JCX0	202
HY133	282	JCX00	202
HY134	282	JCX000	202
HY135	282	JCX0X	202
HY136	282	JCX1	202
HY137	282	JCX1A	202
HY138	282	JCX1X	202
HY150	282	JCX2	202
HY151	282	JCX245	202
HY152	282	JCX2A	202
HY153	282	JCX2X	202
HY154	282	JCX3	202
HY155	282	JCXM00	202
HY156	282	JEY5	346
HY160	283	JP3	221
HY161	283	JP12	221
HY170	283	JP14	230
HY171	283	JP15	233
HY172	283	JP16	233
HY173	283	JP25	233
HY180	283	JP31	221
HY181	283	JP32	221
HY182	283	JP35	225
HY183	283	JP36	225
HY184	283	JP37	225
HY190	283	JP38	221
HY191	283	JP42	230
HY200	283	JP43	232
HY201	283	JP44	230
HY202	283	JP60	226
HY203	283	JP61	232
HY204	283	JP70	233
HY300	282	JP72	226
HY301	282	JP80	223
HY302	282	JP81	223
HY303	282	JP100	230
HY304	282	JP101	221
HY305	282	JP124	221
HY306	282	JP201	222
HY307	282	JP202	222
HY308	282	JP221	222
HY309	282	JP222	222
HY400	282	JP314	230
HY401	282	JP342	230
HY402	282	JP344	230
HY403	282	JP414	230
HY404	282	JP501	229
HY405	282	JP502	229
HY406	282	JPR1	218
HY407	282	JPR2	219
HY408	282	JPR3	219
HY409	282	JSS0	203
J		JSS00	203
JCS0	202	JSS000	203
JCS00	202	JSS0X	203
JCS000	202	JSS1	203
JCS0X	202	JSS1A	203
JCS1	202	JSS1X	203
JCS1A	202	JSS2	203
JCS1X	202	JSS2A	203
JCS2	202	JSS2X	203
		JSS3	203



JSS3X	203	JUX0	204	K159.1035	443	K515.1032	464	K911.0901	466	K918.1424	463
JSS4	203	JUX00	204	K159.1036	443	K515.1050	466	K911.1177	208	K918.1425	463
JSS4X	203	JUX000	204	K159.1037	443	K515.1070	464, 469	K911.1180	208	K918.14255	463
JSS5	203	JUX0X	204	K159.1038	443	K515.1108	464	K911.2027	447	K918.1426	464
JSS6	203	JUX1	204	K159.1040	442	K515.1109	464	K911.2188	482	K918.1427	463
JSS7	203	JUX1A	204	K159.1041	442	K515.1110	464	K911.3862	462	K918.1428	463
JSS245	203	JUX1M	204	K159.1042	442	K515.1111	464	K911.3863	462	K918.1429	463
JSSM00	203	JUX1X	204	K159.1043	442	K515.1112	464	K911.3864	462	K918.1430	463
JUB0N	204	JUX2	204	K159.1044	442	K515.1113	464	K911.3865	462	K918.1431	463
JUB00N	204	JUX2A	204	K159.1045	442	K515.1114	464	K911.3866	462	K918.1432	463
JUB000N	204	JUX2X	204	K159.1046	442	K515.1115	464	K911.3867	462	K918.1433	463
JUB0XN	204	JUX3	204	K159.1047	442	K515.1116	464	K911.3868	462	K918.1449	457
JUB1N	204	JUX100	204	K159.1048	442	K515.1117	464	K911.3869	462	K918.1450	457
JUB1AN	204	JUXM00	204	K159.1049	442	K515.1118	464	K911.3870	462	K918.1801	456
JUB1MN	204	K		K159.1050	443	K515.1119	464	K911.3871	462	K918.1802	456
JUB1XN	204	K115.1028	58	K159.1051	443	K515.1120	464	K911.3872	462	K918.3010	446
JUB2N	204	K115.1029	58	K159.1052	443	K515.1121	464	K911.3873	462	K918.3106	446
JUB2AN	204	K115.1041	208	K159.1053	443	K515.1122	464	K911.3874	462	K918.3111	446
JUB2XN	204	K115.1052	394	K159.1054	443	K515.1123	464	K911.3884	462	K918.3116	446
JUB3N	204	K115.1055	209-210	K159.1055	443	K515.1124	464	K911.3885	462	K918.3206	446
JUB3XN	204	K115.1090	430	K159.1056	443	K515.1125	464	K911.3887	462	K918.3211	446
JUB4N	204	K118.0060	474	K159.1057	443	K515.1126	464	K911.3888	462	K918.3216	446
JUB4XN	204	K120.1050	474	K159.1058	443	K515.1127	464	K911.3889	462	K918.3306	446
JUB5	204	K122.1290	474	K310.0250	374, 469	K515.1128	464	K911.3935	460	K918.3311	446
JUB6N	204	K140.1015	480	K310.0255	374, 469	K515.1129	464	K911.3945	460	K918.3316	446
JUB7N	204	K140.1060	480	K310.0260	374, 469	K515.1130	464	K911.4312	447	K918.3321	446
JUB25	204	K140.2206	480	K310.0350	374, 469	K515.1131	464	K911.8120	169, 172, 477	K918.3406	446
JUB50	204	K140.2211	480	K310.0355	374, 469	K515.1132	464	K913.1290	476	K918.3411	446
JUB100	204	K140.2214	480	K310.0360	374, 469	K515.1243	401, 407	K913.3800	453	K918.3416	446
JUBMOON	204	K140.2248	480	K310.0470	375	K515.1901	225	K913.3880	476	K918.3421	446
JUBS19	205	K140.2290	429, 480	K310.0475	375	K515.1907	225	K916.4050	459	K918.3506	446
JUBS22	205	K140.5255	439	K310.0480	375	K515.2124	465	K918.0610	461	K918.3511	446
JUBS25	205	K140.5257	439	K500.1380	478	K515.2127	465	K918.0611	461	K918.3516	446
JUBS28	205	K150.1305	476	K500.7170	445	K515.2130	465	K918.0612	461	K918.3521	446
JUBS31	205	K150.1450	259	K503.4265	454	K515.2133	465	K918.0627	458	K918.3526	446
JUBS35	205	K150.1970	475	K503.4646	454	K515.3095	403	K918.0635	459	K918.3531	446
JUBS39	205	K150.2024	247	K503.4666	454	K515.3360	224	K918.0646	458	K918.3536	446
JUBS43	205	K150.2035	475	K503.5905	454	K515.3370	224	K918.0661	459	K918.3606	446
JUBS47	205	K150.9310	478	K503.5908	454	K515.3396	224	K918.1200	455	K918.3611	446
JUBS51	205	K151.1100	443	K503.5909	454	K516.1150	469	K918.1210	462	K918.3616	446
JUBS55	205	K151.2100	451	K503.5910	454	K516.1403	468	K918.1211	462	K918.3621	446
JUBS59	205	K151.2180	451	K503.5911	454	K516.1404	468	K918.1212	462	K918.3626	446
JUBS63	205	K152.1100	476	K503.5912	454	K516.1412	468	K918.1213	462	K918.3631	446
JUBS67	205	K156.0180	440	K503.5913	454	K516.1413	468	K918.1214	462	K918.3636	446
JUBS73	205	K156.0690	440	K503.5914	454	K516.1414	468	K918.1215	462	K918.3800	455
JUBS79	205	K159.0020	443	K503.5915	454	K516.1422	468	K918.1216	462	K918.3807	457
JUBS85	205	K159.0030	443	K503.5916	454	K516.1423	468	K918.1217	462	K918.3808	462
JUBS91	205	K159.0040	443	K503.5917	454	K516.1424	468	K918.1218	462	K918.3809	462
JUBS97	205	K159.0100	442	K503.5918	454	K516.1432	468	K918.1219	462	K918.3810	462
JUBS103	205	K159.1001	442	K503.5919	454	K516.1442	468	K918.1220	462	K918.3811	462
JUBS112	205	K159.1002	442	K514.1113	446	K516.1444	468	K918.1221	462	K918.3812	462
JUBS121	205	K159.1003	442	K515.1003	466	K516.1448	468	K918.1222	462	K918.3813	462
JUBS130	205	K159.1004	442	K515.1005	464, 469	K516.1482	468	K918.1224	462	K918.3814	462
JUBS139	205	K159.1005	442	K515.1008	464	K517.0043	453	K918.1227	462	K918.3815	462
JUBS148	205	K159.1006	442	K515.1009	464	K517.0052	453	K918.1232	462	K918.3816	462
JUBS161	205	K159.1007	442	K515.1010	464	K518.0370	475	K918.1234	462	K918.3817	462
JUBS174	205	K159.1008	442	K515.1011	464	K518.0643	452	K918.1236	462	K918.3818	462
JUBS187	205	K159.1009	442	K515.1012	464	K518.0800	452	K918.1240	463	K918.3819	462
JUG3	359	K159.1010	442	K515.1013	464	K519.0660	453	K918.1241	463	K918.3826	456
JUG6	354	K159.1011	442	K515.1014	464	K550.1001	479, 481	K918.1242	463	K918.3826-1	456
JUG8	354	K159.1012	442	K515.1015	464	K550.1002	481	K918.1243	463	K918.3828	463
JUG10	354	K159.1013	442	K515.1016	464	K550.1003	481	K918.1244	463	K918.3829	463
JUG11	350	K159.1020	442	K515.1017	464	K550.1022	479	K918.1245	463	K918.3830	463
JUG12	354	K159.1021	442	K515.1018	464	K550.1045	477	K918.1246	463	K918.3831	463
JUG16	354	K159.1022	442	K515.1019	464	K550.1290	482	K918.1247	463	K918.3832	463
JUG17	354	K159.1023	442	K515.1020	464	K550.1501	482	K918.1248	463	K918.3833	463
JUG21	358	K159.1024	442	K515.1021	464	K700.1120	473	K918.1249	463	K918.3834	463
JUG22	358	K159.1025	442	K515.1022	464	K700.1130	473	K918.1250	457	K918.3835	463
JUG23	358	K159.1026	442	K515.1023	464	K700.1190	479	K918.1252	463	K918.3836	463
JUG23A	358	K159.1027	442	K515.1024	464	K700.1193	479	K918.1254	463	K918.3837	463
JUG31	358	K159.1028	442	K515.1025	464	K700.1195	41	K918.1257	463	K918.3838	463
JUG32	358	K159.1029	442	K515.1026	464	K850.0300	488	K918.1258	463	K918.3839	463
JUG33	358	K159.1030	443	K515.1027	464	K850.0305	488	K918.1260	463	K918.3937	462
JUM10	205	K159.1031	443	K515.1028	464	K850.0505	488	K918.1270	455	K918.3997	455
JUM30	205	K159.1032	443	K515.1029	464	K907.2105	428	K918.1292	456	K919.0123	456
JUS1	205	K159.1033	443	K515.1030	464	K907.2174	429	K918.1292-1	456	K919.0143	456
JUS2	205	K159.1034	443	K515.1031	464	K907.2210	428	K918.1400	455	K919.0383	456





K920.1490	455	MX7600	382
K920.3890	455	MX7122	382
K920.1290	455	MX7232	382
K960.1160	395	MX7432	382
K960.1200	395	MX7800	382
K975.2020	447	MX7825	382
K975.2025	447	MX7850	382
K975.2027	447	MX9002	382
K975.2030	447	MX9003	382
K975.2040	447	MX9020	382
K975.2045	447	MX9030	382
K975.2050	447	MX9100	382
K975.2055	447	MX9200	382
K975.2060	447	MX9400	382
KN782	59,432	MX9500	382
KN792	437	MX9600	382

L		N	
LP1	157	NIL1	290
LP2	157	NIL5	290
LP4	157	NIL11	346
LP5	158	NIL15	346
LP6	158	NIL605	296
LP7	158	NIL606	296
LP8	158	NIL607	296
LP9	158	NIL618	346
LP10	157	NIL624	346
LP11	157	NIL630	346

M		NP1	140
MB261	275	NP2	140
MB262	275	NP3	141
MB263	275	NP4	141
MB264	275	NP5	140
MB265	275	NP6	141
MB266	275	NP7	141
MEM32	68	NP8	141
MKIT1	172	NP9	141
MP1	330	NP10	140
MP2	331	NP11	140
MP3	331	NP12	140
MP4	331	NP13	141
MP5	331	NP14	141
MP6	330	NP15	141
MP7	330	NP16	140
MP8	330	NP17	140
MP9	330	NP18	140
MP10	331	NP19	141
MP11	331	NP20	140
MP12	331	NP21	140
MT10	320	NP22	141
MT11	320	NP23	141
MT12	320	NP24	140
MT24	320	NP25	140
MT48	320	NP26	140
MT225	320	NP33	141
MT250	320	NP34	141
MX2385	381	NP35	141
MX2395	380	NP36	141
MX2475	380	NP37	141
MX2485	381	NP38	141
MX2495	380	NP39	140
MX2505	381	NP40	140
MX3405	381	NST4	125
MX5120	381	NST5	125
MX5230	381	NST6	125
MX5330	381	NST8	125
MX5430	381	NST10	125
MX6100	383	NST14	125
MX6200	383	NST15	125
MX6401	383	NST16	125
MX6600	383	NST18	125
MX6700	382	NST24	125
MX6750	382	NST25	125
MX7002	382	NST26	125
MX7003	382	NST28	125
MX7060	382	NST34	125
		NST35	125

NST36	125	O	
NST38	125	OC1	206
NST40	125	OC1A	206
		OC2	206
		OC2A	206
		OC3	206
		OC3A	206
		OC4	206
		OC4A	206
		OC5	206
		OC5A	206
		OC6	206
		OC6A	206
		OC7	206
		OC7A	206
		OC11	206
		OC12	206
		OC13	206
		OC14	206
		OC15	206
		OC16	206
		OC17	206
		OC18	206

P		PG1	285
PAD1	484	PG2	285
PAD2	484	PG3	285
PAD3	484	PG4	285
PAD4	484	PG5	285
PAD5	484	PG6	285
PAD6	486	PG7	285
PAD7	487	PG8	285
PAD9	487	PG9	285
PAD12	486	PG10	285
PAD13	487	PG12	285
PAD14	486	PG13	285
PAD15	485	PG14	285
PAD16	486	PG15	285
PAD17	486	PG16	285
PAD20R	487	PG17	285
PAD21	485	PG18	285
PAD22	485	PG19	285
PAD23	485	PG20	285
PAD25	486	PG21	285
PAD26	486	PG22	285
PAD30	484	PG23	285
PAD38	484	PG24	285
PAD50	484	PG25	285
PAD63	484	PG26	285
PAD95	486	PG27	285
PAD110	485	PG28	285
PAD110S	485	PG29	285
PAD130	484	PG30	285
PAD138	484	PG31	285
PAD150	484	PG32	285
PAD163	484	PG33	285
PAD170	486	PG35	285
PAD195	486	PJ1	207
PAD230	484	PJ2	207
PAD230K	484	PJ3	207
PAD240	484	PJ4	207
PAD240K	484	PJ5	207
PAD240LS	484	PJ6	207
PAD250	484	PJ105	207
PAD250K	484	PJ106	207
PAD250LS	484	PJ108	207
PAD260	484	PJ110	207
PAD260K	484	PJ112	207
PAD330	484	PJ116	207
PAD340	484	PJ119	207
PAD350	484	PJ212	207
PAD350C	485	PJ216	207
PB1/2	317	PJ219	207

PB1	317	PJ306	207
PB1 1/2	317	PJ308	207
PB2	317	PJ310	207
PB3	317	PJ312	207
PB4	317	PJ316	207
PB48	317	PJ319	207
PB49	317	PJ406	207
PB51	317	PJ408	207
PB52	317	PJ410	207
PB53	317	PJ412	207
PB54	317	PJ416	207
PB62	317	PJ419	207
PB64	317	PR1	153
PB66	317	PR2	153
PB68	317	PR3	153
PB100	316	PR4	153
PB101	316	PR5	153
PB102	316	PR6	153
PB103	316	PR7	153
PB104	316	PR8	153
PB110	316	PR9	153
PB111	316	PR10	151,190
PB112	316	PR11	153
PB120	316	PR12	151,190-191
PB121	316	PR47	151
PC1	206	PR48	151
PC2	206	PR49	151
PC3	206	PR101	152
NP1	285	PR102	152
PG2	285	PR103	152
PG3	285	PR104	152
PG4	285	PR105	152
PG5	285	PR106	152
PG6	285	PR107	152
PG7	285	PR108	152
PG8	285	PR109	152
PG9	285	PR111	152
PG10	285	PR112	151
PG12	285	PR114	151
PG13	285	PR214	151
PG14	285	PRB11	152
PG15	285	PRB12	152
PG16	285	PRB13	152
PG17	285	PRB21	152
PG18	285	PRB22	152
PG19	285	PRB23	152
PG20	285	PRB24	152
PG21	285	PRB25	152
PG22	285	PRC50	153
PG23	285	PRC53	153
PG24	285	PRC54	153
PG25	285	PRC56	153
PG26	285	PRC58	153
PG27	285	PRL1	153
PG28	285	PRL2	153
PG29	285	PRL5	153
PG30	285	PRL6	153
PG31	285	PRL7	153
PG32	285	PRL8	153
PG33	285	PRL49	151
PG35	285	PRS4	151
PJ1	207	PRS5	151
PJ2	207	PRW1	132,151
PJ3	207	PS1	266
PJ4	207	PS2	266
PJ5	207		
PJ6	207		
PJ105	207		
PJ106	207		
PJ108	207		
PJ110	207		
PJ112	207		
PJ116	207		
PJ119	207		
PJ212	207		
PJ216	207		
PJ219	207		

Q		QB10	329
QB10A	329		
R		REF1	275
REF1S	275	REF2	275
REF2S	275	REF25	275
REF3	275	REF3S	275

REF4	275	S	
REF4S	275	SAS1	309
REF5A	275	SAS2	300
REF7A	275	SAS3	41,310
REF9A	275	SAS4	301
RTS1	235,242	SAS5	301
RZ1001	338	SAS6	307
RZ1002	338	SAS7	309
RZ1004	338	SAS8	310
RZ1005	338	SAS9	310,393
RZ1104	338	SAS10	301
RZ2001	339	SAS12	309
RZ2004	339	SAS14	309
RZ2011	339	SAS15	291
RZ2014	339	SAS16	291
RZ3004	338	SAS17	305
		SAS18	309
		SAS19	310
		SAS20	307
		SAS21A	307-308
		SAS22	307
		SAS22A	307
		SAS23	307
		SAS24	312
		SAS25	314
		SAS27	314
		SAS28	314
		SAS29	314
		SAS30	314
		SAS31	314
		SAS32	291
		SAS33A	309
		SAS35	313
		SAS36	313
		SAS37	313
		SAS43	291
		SAS46	309,416
		SAS50	395
		SAS51	291
		SAS52	300
		SAS53	299,301
		SAS54	291
		SAS55	291
		SAS56	309
		SAS57	250,310
		SAS58	301
		SAS59	314
		SAS62	300
		SAS62T	300,355
		SAS63A	311
		SAS64A	313
		SAS65A	312
		SAS66A	313
		SAS67A	313
		SAS68A	312
		SAS72	300
		SAS81	300
		SAS81A	300
		SAS107	305
		SAS107A	305



SAS147	308	SAS572	335	SB13	491	SSA129	364	SSA418	372	SSB325	370
SAS171	305	SAS572/12	335	SB14	491	SSA131	364	SSA420	372	SSB401	372
SAS173	305	SAS574	332	SB15	491	SSA133	364	SSA422	372	SSB403	372
SAS180	305	SAS574/12	332	SB21BU	490	SSA135	364	SSA424	372	SSB405	372
SAS181	305	SAS590	333	SB21RE	490	SSA137	364	SSB102	364	SSB407	372
SAS188	305	SAS590/12	333	SB22BU	490	SSA202	368	SSB104	364	SSB409	372
SAS188A	305	SAS591	333	SB22RE	490	SSA204	368	SSB106	364	SSB411	372
SAS190	305	SAS592	333	SB23BU	490	SSA206	368	SSB108	364	SSB413	372
SAS190A	305	SAS593	333	SB23RE	490	SSA208	369	SSB110	364	SSB415	372
SAS192	305	SAS593/12	333	SB30	490	SSA210	369	SSB112	364	SSB417	372
SAS192A	305	SAS601	327	SB31	490	SSA212	369	SSB114	364	SSB419	372
SAS193	305	SAS601/12	327	SB32	490	SSA214	368	SSB116	365	SSB421	372
SAS194	304	SAS638	327	SB33	490	SSA216	369	SSB118	365	SSB423	372
SAS202B/3	333	SAS638/12	327	SB34	490	SSA218	369	SSB120	365	SSB501	373
SAS202B/12	333	SAS701	288	SB35	490	SSA220	368	SSB122	364	SSB502	373
SAS202C/3	333	SAS701/12	288	SB50	489	SSA222	369	SSB124	364	SSB503	373
SAS202C/12	333	SAS702	288	SB51	489	SSA224	369	SSB126	364	SSB504	373
SAS202W/3	333	SAS702/12	288	SB52	489	SSA226	369	SSB128	364	SSB505	373
SAS202W/12	333	SAS703	288	SB60	489	SSA228	368	SSB130	364	SSB506	373
SAS210/6	336	SAS703/12	288	SB61	491	SSA230	369	SSB132	364	SSB507	373
SAS210/12	336	SAS1059	301, 346	SB62	489	SSA232	369	SSB134	364	STAP4	155
SAS220	336	SAS1060/2	269, 289	SB63BU	491	SSA234	369	SSB136	364	STAP5	155
SAS220/12	336	SAS2000T	294, 300, 355	SB63RE	491	SSA236	369	SSB138	365	T	
SAS222/5	326	SAS2010	300, 346	SB70	489	SSA238	369, 371	SSB139	365	T401-10	434
SAS222/12	326	SAS2011	295	SB70B	489	SSA239	368	SSB140	365	T401-7	434
SAS2220	326	SAS2015	294	SB70G	489	SSA240	368	SSB141	365	T580	488
SAS2220/12	326	SAS2016	294	SB70R	489	SSA241	368	SSB142	365	T580A	488
SAS243/5	326	SAS2017	295	SB70Y	489	SSA242	368	SSB143	365, 371	T705	426
SAS243/12	326	SAS2021	295	SB85B	489	SSA243	368	SSB201	368	T710	429
SAS2430	326	SAS2022	295	SB85G	489	SSA244	368	SSB203	368	T710N	429
SAS2430/12	326	SAS2033	294	SB85R	489	SSA245	368	SSB205	368	T1200-72N	455
SAS271/5	326	SAS2034	295	SB85Y	489	SSA246	368	SSB207	369	T1200FRP	455
SAS271/12	326	SAS2040	295	SB86B	489	SSA254	366	SSB209	369	T1201	456
SAS2710	326	SAS2041	294	SB86G	489	SSA255	366	SSB211	369	T1292AG-E4	469
SAS2710/12	326	SAS2043	294	SB86R	489	SSA256	366	SSB213	368	T1292AG-EP	469
SAS325	325	SAS2045	295	SB86Y	489	SSA257	366	SSB215	369	T1400-72N	455
SAS380	327	SAS2046	295	SB87B	489	SSA258	366	SSB217	369	T1400FRP	455
SAS390	327	SAS2058	294, 301	SB87G	489	SSA259	366	SSB219	368	T1479AF	451
SAS391	327	SAS2132	294	SB87R	489	SSA260	366	SSB221	369	T1479MMA	451
SAS401/5	325	SAS2501A	293	SB87Y	489	SSA261	366	SSB223	369	T1479TX	451
SAS40B	315	SAS2502A	293	SB94	492	SSA263	367	SSB225	369	T3800-72N	455
SAS40R	315	SAS2503A	293	SB95	490	SSA265	367	SSB227	368	T3800FRP	455
SAS40W	315	SAS2506A	292	SB100	26, 493	SSA267	367	SSB229	369	T3892AG-E1	469
SAS40Y	315	SAS2508A	293	SB101	3, 26, 493	SSA269	367	SSB231	369	T3892AG-E3	469
SAS422	325	SAS2510A	292	SB102	26, 493	SSA271	366	SSB233	369	T4002	453
SAS422/12	325	SAS2511A	292	SB106	26, 493	SSA273	366	SSB235	369	T4003	453
SAS450	327	SAS2515A	292	SB112	26, 493	SSA274	367	SSB237	369, 371	T4004	453
SAS454	325	SAS2516A	292	SB116	26, 493	SSA275	367	SSB247	371	T4005	453
SAS454/20	325	SAS2517A	292	SB118	26, 493	SSA276	367	SSB248	371	T4006	453
SAS460	327	SAS2543A	292	SB124	26, 493	SSA277	367	SSB249	371	T4007	453
SAS470	325	SAS2545A	292	SB140	494	SSA278	367	SSB250	371	T6510A	452
SAS495/5	325	SASC	235, 299, 318, 414	SB141	494	SSA280	367	SSB251	371	T9121	466
SAS495/24	325	SASKIT1	325	SB142	494	SSA282	367	SSB252	371	T9126	466
SAS4950	325	SASL	235, 310, 318, 414	SB143	494	SSA284	367	SSB253	371	T600507	452
SAS4950/12	325	SASNOZ	333-334	SO1	394	SSA286	367	SSB262	367	T600508	452
SAS500	338	SASP	235, 315, 318, 414	SO2	394	SSA288	367	SSB264	367	T600508R	454
SAS501	341	SASV	236, 290, 318, 414	SO3	394	SSA302	370	SSB266	367	T600510	452
SAS501A	341	SASVP1	293	SO4	394	SSA304	370	SSB268	367	T600510R	454
SAS502	341	SASVP2	293	SO6	394	SSA306	370	SSB270	366	T600513	454
SAS503	341	SASVP3	293	SO8	394	SSA308	370	SSB272	366	T600515	452
SAS504	341	SB1BU	491	SO18	394	SSA310	370	SSB279	367	T600515R	454
SAS504A	341	SB1RE	491	SO22	394	SSA312	370	SSB281	367	T600517	452
SAS505	341	SB1DIV	491	SO9	394	SSA314	370	SSB283	367	T600517R	454
SAS506	341	SB2BU	491	SSA101	365	SSA316	370	SSB285	367	T600519	454
SAS506A	341	SB2RE	491	SSA103	364	SSA318	370	SSB287	367	T600521	452
SAS511	341	SB2DIV	491	SSA105	364	SSA320	370	SSB301	370	T600522	452
SAS512	341	SB3BU	491	SSA107	364	SSA322	370	SSB303	370	T600522R	454
SAS514	341	SB3RE	491	SSA109	364	SSA324	370	SSB305	370	T600524	454
SAS515	341	SB3DIV	491	SSA111	364	SSA326	370	SSB307	370	T600527	452
SAS516	341	SB4	491	SSA113	364	SSA402	372	SSB309	370	T600530	452
SAS520	340, 344	SB5	491	SSA115	364	SSA404	372	SSB311	370	T600536	452
SAS527	340, 344	SB7BU	491	SSA117	365	SSA406	372	SSB313	370	T601013	452
SAS530	338	SB7RE	491	SSA119	365	SSA408	372	SSB315	370	T910086	465
SAS540	340	SB7DIV	491	SSA121	365	SSA410	372	SSB317	370		
SAS541	340	SB8BU	491	SSA123	364	SSA412	372	SSB319	370		
SAS542	340	SB8RE	491	SSA125	364	SSA414	372	SSB321	370		
SAS543	340	SB8DIV	491	SSA127	364	SSA416	372	SSB323	370		





T910630R	465	TAPE31	322	TC43	211	TC520	214	TC1030	215	TL474	447
T910632R	465	TAPE40	322	TC44	210	TC521	214	TC1031	215	TL479	447
T910633R	465	TAPE41	322	TC45	210	TC522	214	TC1040	215	TL480	466
T920020	465	TAPE42	322	TC46	210	TC523	214	TC1050	207, 215	TL521	423
T920021	465	TAPE43	322	TC47	210	TC524	214	TC1051	207, 215	TL522	423
T920023	465	TAPE44	322	TC48	210	TC525	214	TCX20	212	TL523	423
T920030	465	TAPE45	322	TC49	210	TC526	214	TCX21	212	TL524	423
T920036	465	TAPE50	321	TC50	210	TC540	214	TCX22	212	TL525	423
T920037	465	TAPE52	322, 495	TC51	210	TC541	214	TCX23	212	TL526	420
T920510	464	TAPE53	321	TC52	210	TC542	214	TCX24	212	TL535	420
T920511	464	TAPE54	321	TC53	210	TC543	214	TCX25	212	TL536	420
T920512	464	TAPE55	323	TC54	210	TC544	214	TCX26	212	TL537	420
T920513	464	TB1	428	TC55	210	TC545	214	TCX27	212	TL538	420
T920514	464	TB244	427	TC56	210	TC546	214	TCX28	212	TL540	422
T920515	464	TB268	426	TC66	211	TC547	214	TCX29	212	TL541	422
T920516	464	TB317	425	TC68	211	TC550	214	TCX30	212	TL542	423
T920517	464	TB319	425	TC70	211	TC551	214	TCX31	212	TL543	423
T920518	464	TB1018	425	TC72	211	TC552	214	TCX40	212	TL544	423
T920519	464	TB1018C	425	TC74	211	TC553	214	TCX41	212	TL545	423
T920521	464	TB1024	425	TC76	211	TC554	214	TCX42	212	TL546	423
T920522	464	TB1024C	425	TC78	211	TC555	214	TCX43	212	TL547	423
T920524	464	TB1032	425	TC80	211	TC556	214	TCX50	212	TL549	423
T920610	465	TB1032C	425	TC82	211	TC557	214	TCX51	212	TL569	421
T920611	465	TB2032	426	TC90	211	TC558	214	TCX52	212	TL571	421
T920612	465	TB2101G4	430	TC91	211	TC560	214	TCX53	212	TL572	421
T920613	465	TB2101G6	430	TC92	211	TC561	214	TCX54	212	TL573	421
T920614	465	TB2221	426	TC93	211	TC562	214	TCX55	212	TL577	421
T920615	465	TB2320	426	TC99	209, 211	TC563	214	TCX56	212	TL578	421
T920616	465	TB2321	426	TC104	213	TC564	214	TCX99	209, 212	TL581	421
T920617	465	TB2330	426	TC105	213	TC565	214	TCX104	212	TL582	421
T920618	465	TB2331	426	TC106	213	TC570	214	TCX105	212	TL586	421
T920619	465	TB2430	426	TC108	213	TC571	214	TCX114	212	TL587	421
T920621	465	TB4512	427	TC110	213	TC572	214	TCX116	212	TL590	426
T920622	465	TB4522	427	TC112	213	TC573	214	TCX118	212	TL591	426
T920624	465	TB8070	453	TC124	213	TC574	214	TCX120	212	TL592	426
T920627	465	TB8071	453	TC125	213	TC575	214	TCX122	212	TL593	426
T920628	465	TB8072	453	TC126	213	TC576	214	TFC01	298	TL594	426
T920629	465	TB8073	453	TC128	213	TC577	214	TID515	466	TL595	426
T920630	465	TB8074	453	TC130	213	TC578	214	TID515BIT	466	TL596	426
T920632	465	TB8075	453	TC132	213	TC579	214	TK6400	453	TL605	425
T920635	465	TB9031	453	TC206	213	TC580	214	TL106	482	TL607	425
T920636	465	TB9897	434	TC208	213	TC581	214	TL125	169, 172, 477	TL607A	425
T940037	465	TB47808	412	TC209	213	TC582	214	TL130	33, 395	TL608	425
T940085	465	TB47810	412	TC210	213	TC583	214	TL132	480	TL608A	425
T940622	465	TC1	213	TC211	213	TC584	214	TL151	444	TL609	425
T940624	465	TC2	213	TC212	213	TC585	214	TL200	482	TL609A	425
T940627	465	TC3	213	TC300	211	TC586	214	TL230	430	TL615	411, 426
T940630	465	TC4	213	TC301	211	TC587	214	TL232	430	TL616	411, 426
T940632	465	TC5	213	TC302	211	TC600	214	TL252	59	TL622	425
T940633	465	TC6	213	TC303	211	TC601	214	TL254	247	TL622A	425
T940636	465	TC7	213	TC304	211	TC602	214	TL255	431	TL623	425
T980035	465	TC8	213	TC305	211	TC603	214	TL258	208	TL623A	425
T980036	465	TC9	213	TC306	211	TC604	214	TL345	450	TL624	425
TA101	217, 269	TC10	213	TC307	211	TC605	214	TL346	450	TL624A	425
TA102	217, 269	TC11	213	TC308	211	TC606	214	TL347	450	TL625	427
TA103	217, 269	TC12	213	TC309	211	TC607	214	TL348	448	TL626	427
TA104	217, 269	TC13	213	TC310	211	TC1001	215	TL349	448	TL627	427
TA105	217, 269	TC14	213	TC311	211	TC1002	215	TL350	448	TL628	427
TAPE2	322, 495	TC15	213	TC312	211	TC1003	215	TL351	449	TL629	427
TAPE3	322, 495	TC16	213	TC313	211	TC1004	215	TL352	448	TL630	427
TAPE4	321	TC17	213	TC500	215	TC1005	215	TL353	450	TL631	425
TAPE4B	321	TC19	213	TC501	215	TC1006	215	TL354	450	TL633	426
TAPE5	321	TC20	210	TC502	215	TC1007	215	TL355	434	TL634	426
TAPE5B	321	TC21	210	TC503	215	TC1008	215	TL356	434	TL638	426
TAPE6	321	TC22	210	TC504	215	TC1010	215	TL357	449	TL645	427
TAPE7	321	TC23	210	TC505	215	TC1011	215	TL358	449	TL647	427
TAPE7B	321	TC24	210	TC506	215	TC1012	215	TL359	449	TL649	427
TAPE8	321	TC25	210	TC507	215	TC1020	215	TL430	487	TL654	427
TAPE8B	321	TC26	210	TC508	215	TC1021	215	TL431	487	TL655	427
TAPE10	322, 495	TC27	210	TC510	214	TC1022	215	TL432	487	TL658	429
TAPE11	322, 495	TC28	210	TC511	214	TC1023	215	TL433	487	TL659	429
TAPE20	360	TC29	210	TC512	214	TC1024	215	TL434	487	TL660	429
TAPE21	360	TC30	210	TC513	214	TC1025	215	TL451	437	TL662	429
TAPE24	322, 360	TC31	210	TC514	214	TC1026	215	TL452	437	TL663	430
TAPE25	322, 360	TC40	211	TC515	214	TC1027	215	TL453	437	TL664	430
TAPE26	322	TC41	211	TC516	214	TC1028	215	TL455	437	TL665	430
TAPE30	322	TC42	211	TC517	214	TC1029	215	TL472	456	TL666	430

TL670	429	TL930	58	TL8014	461,487	TM120519	462	TM380519	462	TNAV28	424
TL671	428	TL931	58	TL8020	290	TM120520	462	TM380520	462	TNAV32	424
TL672	428	TL932	58	TL8021	290	TM120521	462	TM380521	462	TNAV36	424
TL673	430	TL933	58	TL8022	290	TM120522	462	TM380522	462	TNAV40	424
TL675	430	TL934	58	TL8038	461,487	TM120523	462	TM380607	463	TNAV44	424
TL676	430	TL935	58	TL8050	452,487	TM120524	462	TM380608	463	TNAV48	424
TL677	430	TL936	36,58	TL8100	155	TM120525	462	TM380609	463	TNAV64	424
TL678	430	TL940	58	TL8110	155	TM120526	462	TM380610	463	TNAV125	424
TL682	429	TL952	394	TL9000	473	TM120527	462	TM380611	463	TNAV155	424
TL683	429	TL955	395	TL9190	456	TM120528	462	TM380612	463	TNAV315	424
TL689	437	TL956	398	TL9190H	456	TM120529	462	TM380613	463	TNAV2	424
TL695	437	TL961	474	TL9240	208	TM120530	462	TM380614	463	TNB2TM	481
TL698	437	TL961R	474	TL9241	208	TM120532	462	TM380615	463	TNB12592	450
TL700	439	TL962	475	TL9290	456	TM120610	463	TM380616	463	TNB12595	450
TL701	438	TL962F	475	TL9290H	456	TM120611	463	TM380617	463	TNB12632	450
TL702	438	TL965	475	TL9370	482	TM120612	463	TM380618	463	TNB12634	450
TL703	438	TL965M	475	TL13109	448	TM120613	463	TM380619	463	TNB20199	451
TL704	438	TL970	475	TL13110	448	TM120614	463	TM380620	463	TNB69499	451
TL705	438	TL971	475	TL13111	448	TM120615	463	TM380621	463	TNB69699	451
TL706	438	TL972	475	TL13112	448	TM120616	463	TM380622	463	TNB21	446
TL707	438	TL973	475	TL13113	448	TM120617	463	TMB416	436	TNB22	446
TL708	438	TL974	475	TL13114	448	TM120618	463	TMB441-6	430	TNB23	446
TL711	438	TL975	475	TL13160	448	TM120619	463	TMB442-8	430	TNC1/135	436
TL712	438	TL976	475	TL13164	448	TM120620	463	TMB452-8	435	TNC1/175	436
TL713	438	TL977	475	TL13168	448	TM120621	463	TMB461-8	435	TNC1/220	436
TL714	439	TL978	475	TL13172	448	TM120622	463	TMB481-10	436	TNC1/310	436
TL715	439	TL979	475	TL13176	448	TM120624	463	TMD691	445	TNC2/165	436
TL716	439	TL980	475	TL13252	448	TM120627	463	TMD692	445	TNC2/200	436
TL721	438	TL981	475	TL13254	448	TM120630	463	TMD912N	445	TNC3/135	436
TL723	438	TL982	475	TL13256	448	TM120632	463	TMD920	445	TNC3/175	436
TL724	438	TL983	475	TL13352	448	TM120636	463	TMD921	445	TNC3/220	436
TL725	438	TL984	475	TL13354	448	TM140020	457	TMD922	445	TNC3/310	436
TL727	438	TL985	475	TL13356	448	TM140021	457	TMD923	445	TNC4/165	436
TL729	438	TL986	475	TL13360	448	TM140022	457	TMD928	445	TNC4/200	436
TL730	271	TL992	250	TL13364	448	TM140030	457	TMD933	445	TNE3	59,430
TL751	412	TL994	250	TL13368	448	TM140036	457	TMD934	445	TNFG135	437
TL766	412	TL995	437	TL13372	448	TM140504	462	TMD940	445	TNH25C	481
TL784	412	TL996	437	TL13376	448	TM140505	462	TMD941	445	TNH160	209
TL800	154	TL1000	246,477	TL133009	448	TM1405055	462	TMD948	445	TNH170	481
TL801	154	TL1000C	246,477	TL33010	448	TM140506	462	TMD952	445	TNH251	478
TL802	154	TL1001	331	TL33015	448	TM140507	462	TMD953	445	TNH253	478
TL803	154	TL1008	444	TL33020	448	TM140508	462	TMD960	445	TNH255	478
TL804	154	TL1009	444	TL33025	448	TM140509	462	TMD961	445	TNH259	478
TL811	154	TL1100	447	TL33027	448	TM140510	462	TMD972	445	TNH266C	401,412
TL816	154	TL1200	423	TL33030	448	TM140511	462	TMD973	445	TNH276	478
TL817	154	TL1300	479	TL33040	448	TM140512	462	TN106KM	441	TNH277	478
TL822	154	TL1310	481	TLA341	58	TM140513	462	TN200	424	TNH278	478
TL822-2	154	TL1320	481	TLD19	419	TM140604	463	TN250	424	TNH297	478
TL822-3	154	TL2620	455	TLD25	419	TM140605	463	TN4101KM	441	TNH310	472
TL822-4	154	TL2630	455	TLD29	419	TM1406055	463	TN7001K	441	TNH311	472
TL822-5	154	TL2640	455	TM13	418	TM140606	463	TN7014K	441	TNH315	472
TL822-6	154	TL3860	461	TM1208-6	461	TM140607	463	TN9425	481	TNH316	472
TL823	154	TL3890	455	TM1212	460	TM140608	463	TN60000	477	TNH320	472
TL825	155	TL4050	455	TM1213TX	460	TM140609	463	TN60003	477	TNH321	472
TL826	155	TL4060	456	TM1215MM	460	TM140610	463	TN60150	439	TNH324	472
TL831	125	TL4060H	456	TM1407	461	TM140611	463	TN61350	440	TNH325	472
TL832	125	TL4100	440	TM1412	460	TM140612	463	TN61355	440	TNH326	472
TL833	125	TL4102	441	TM3807	461	TM140613	463	TNA4LN	434	TNH326-1	472
TL834	125	TL4104	441	TM3812	460	TM380020	457	TNA4WR	434	TNH326-3	472
TL835	125	TL7108	439	TM3814	460	TM380021	457	TNA5WR	434	TNH330	472
TL880	328	TL7112	412	TM3816	460	TM380022	457	TNA6LN	434	TNH521C	436
TL881	328	TL7116	439	TM120020	457	TM380030	457	TNA6R	434	TNH650	476
TL882A	258,288	TL7120	401	TM120021	457	TM380036	457	TNA7R	434	TNH765	474
TL885	333-334,336	TL7124	439	TM120022	457	TM380040	461	TNA7WR	434	TNH770	479
TL887	242,329	TL7132	439	TM120030	457	TM380046	461	TNA9LN	434	TNH826	474
TL890	155	TL7140	439	TM120036	457	TM380507	462	TNA9R	434	TNH900	473
TL895	303	TL7170	439	TM120508	462	TM380508	462	TNA10R	434	TNH52230	428
TL899	303	TL7215	482	TM120509	462	TM380509	462	TNA10WR	434	TNKBD3	440
TL905	209	TL7225	473	TM120510	462	TM380510	462	TNA11R	434	TNM24K	424
TL906	209	TL7400	356,473	TM120511	462	TM380511	462	TNAV5M	424	TNM34	424
TL907	209	TL7402	479	TM120512	462	TM380512	462	TNAV10	424	TNM45P	424
TL909	209	TL7403	477	TM120513	462	TM380513	462	TNAV12	424	TNP1/180	435
TL920	227,303	TL7410	229	TM120514	462	TM380514	462	TNAV14	424	TNP1/205	435
TL921	333-334,336	TL7600	395	TM120515	462	TM380515	462	TNAV18	424	TNP2/170	435
TL922	303	TL7635	422,479	TM120516	462	TM380516	462	TNAV19	424	TNP2/205	435
TL923	208	TL7636	422,479	TM120517	462	TM380517	462	TNAV20	424	TNP4/160	431
TL928	203,208,250	TL8012	461,487	TM120518	462	TM380518	462	TNAV24	424	TNP4/180	431





TNP5/150	431	TTTTD17	422	TUS9045	216	TY173	245	TY417C	246	VAC9	351
TNP5/180	431	TTTTX7	449	TUS9048	216	TY174	248, 470	TY417R	246	VAC11	351
TNP5/200	431	TTTVG05	434	TUS9051	216	TY175	244	TY418	246	VAC12	352
TNP5/240	431	TTTX2032	452	TUS9057	216	TY176	244	TY418C	246	VAC13	351
TNP6/200	431	TTTXEXT13	457	TUS9060	216	TY177	244	TY419	246	VAC14	351
TNP9/300	436	TTTXPB3	439	TW105	247	TY178	244	TY419C	246	VAC15	352
TNP9/400	436	TTTXPB3A	440	TW110	247	TY179	244	TY419R	246	VAC16	351
TNR1/180	435	TUB2	217	TW115	247	TY180	244	TY421	246	VAC17	352
TNR1/205	435	TUB3	217	TW120	247	TY190	239	TY421C	246	VAC18	351
TNR2/205	435	TUB4	217	TW125	247	TY191	239	TY421R	246	VAC19	352
TNR4/160	431	TUB5	217	TW130	247	TY192	240	TY422	246	VAC20	351
TNR6/180	60, 431	TUB11	217	TW135	247	TY193	240	TY422C	246	VAC21	352
TNR7/210	59, 431	TUB12	217, 269	TW140	247	TY194	240	TY423	246	VAC23	352
TNR8/200	60, 435	TUB13	217	TW405	247	TY195	240	TY424	246	VAC24	352
TNR9/200	59, 431	TUB14	217	TW410	247	TY196	240	TY424C	246	VAC30	352
TNR255	431	TUB21	217	TW415	247	TY197	240	TY424R	246	VAC32	352
TNS120	60, 444	TUB42	217	TW420	247	TY220	243	TY425	246	VAC33	353
TNS130	60, 444	TUB44	217	TW425	247	TY221	243	TY426	246	VAC34	353
TNS140	60, 444	TUB45	216	TW430	247	TY222	243	TY426C	246	VAC42	353
TNS150	60, 444	TUB46	216	TW435	247	TY223	243	TY426R	246	VAC50	351
TNS200	60, 444	TUB47	216	TW440	247	TY224	243	TY427	246	VAC51	351
TNS210	60, 444	TUB48	216	TW500	247	TY225	243	TY427C	246	VAC52	353
TNS220	60, 444	TUB50	217	TW560	247	TY240	243	TY427R	246	VAC53	353
TNS300	60, 444	TUB51	217	TW600	247	TY241	243	TY428	246	VAC62	353
TNS310	60, 444	TUB52	217	TY100	239	TY242	243	TY428R	246	VAC63	353
TNS320	60, 444	TUB53	217	TY101	238	TY245	243	TY429	246	VAC64	353
TNS500	60, 444	TUB54	217	TY102	238	TY246	243	TY429C	246	VAC70	351
TNS700	60, 444	TUB56	217	TY103	238	TY247	243	TY429R	246	VAC71	351
TNV1/180	59, 432	TUB60	218, 354	TY104	238	TY250	244	TY430	246	VAC72	353
TNV1/205	59, 432	TUB69	216	TY105	238	TY251	243	TY430C	246	VAC73	353
TNV2/205	59, 432	TUB70	216	TY106	238	TY252	243	TY430R	246	VAC100	354
TNV4/160	59, 432	TUB71	216	TY111	238	TY253	243	TY431	246	VC51	398
TNV5/190	59, 432	TUB72	216	TY112	238	TY254	243	TY432	246	VC99	355
TNV6/180	60, 432	TUB73	216	TY113	238	TY255	243	TY432C	246	VC115	284, 306
TNV8/200	60, 432	TUB74	216	TY114	238	TY256	242	TY432R	246	VC115A	284, 306
TNV9/200	59, 432	TUB75	216	TY115	238	TY257	242	TY433	246	VC116	284, 306
TNY1	428	TUB81	216	TY116	238	TY258	243	TY433C	246	VC117	284, 306
TNY2	428	TUB82	216	TY117	238	TY259	242	TY433R	246	VC121	345
TNY3	428	TUB83	216	TY118	238	TY260	243	TY434	246	VC122	345
TNY119	428	TUB99	216	TY120	243	TY261	243	TY436	246	VC124	345
TNYP114	428	TUB103	217	TY121	242	TY262	243	TY438	246	VC125	345
TPB16	439	TUB104	217	TY122	242	TY263	243	TY438R	246	VC126	345
TQ1/250	436	TUB105	217	TY123	242	TY264	243	TY441	246	VC127	345
TQ1/300	436	TUB106	217	TY125	243	TY266	243	TY441R	246	VC131	299
TSD501	481	TUB109	217	TY126	242	TY267	242	TY524	246	VC132	299
TT20	271	TUB110	217	TY126B	242	TY290	244	TY527	246	VC140	307-308
TT21	271	TUB111	217	TY127	242	TY291	244	TY530	246	VC145	308
TT22	271	TUB112	217	TY127B	242	TY292	244	TY530R	246	VC151	288
TT27	271	TUS6	216	TY130	239	TY300	241	TY532	246	VC152	288
TT31	271	TUS9	216	TY131	239	TY301	241	TY532R	246	VC153	288
TT33	271	TUS13	216	TY132	239	TY302	241	TY533	246	VC161	311
TT35	271	TUS16	216	TY133	239	TY303	241	TY533R	246	VC162	311
TT38	271	TUS19	216	TY136	239	TY310	241	TY601	245	VC163	311
TT43	270	TUS22	216	TY136B	239	TY330	241	TY602	245	VC165	289
TT44	270	TUS25	216	TY137	239	TY331	241	TY1000	249, 471	VC171	304
TT120	271	TUS28	216	TY138	239	TY332	241	TY1001	249, 471	VC179	304
TT122	271	TUS32	216	TY139	239	TY340	242	TY1002	249, 471	VC180	304
TT124	271	TUS35	216	TY143	238	TY364	238	TY1003	249, 471	VC181	304
TT1221	459	TUS38	216	TY144	238	TY366	238	TY1004	249, 471	VC181A	304
TT1424	458	TUS41	216	TY145	238	TY368	238	TY1005	249, 471	VC182	304
TT1436	458	TUS45	216	TY146	238	TY370	238	TY1006	249, 471	VC184	304
TT3834	458	TUS48	216	TY150	242	TY371	238	TY1011	248, 470	VC187	304
TT3839	458	TUS51	216	TY151	242	TY372	238	TY1014	248, 470	VC188	304
TTC-MAG	488	TUS57	216	TY152	242	TY373	238	TY1020	248, 470	VC189	304
TTC-MAT	488	TUS60	216	TY153	242	TY374	238	TY1100	248, 470	VC191	226
TTF22	209	TUS906	216	TY160	241	TY375	238	TY1101	248, 470	VC199	285, 306
TTF30	209	TUS909	216	TY161	239	TY376	238	TY1200	245	VC203B	334
TTM029	447	TUS9013	216	TY162	241	TY377	238	TY1201	245	VC203BB	334
TTT01	488	TUS9016	216	TY163	241	TY402	245			VC203W	334
TTT1236	452	TUS9019	216	TY164	240	TY403	245			VC203WB	334
TTT440	435	TUS9022	216	TY165	240	TY404	245	VAC2	351	VC204	334
TTT474-7	437	TUS9025	216	TY166	240	TY405	245	VAC3	352	VC205	334
TTT804	473	TUS9028	216	TY167	240	TY412	245	VAC4	351	VC211	336
TTT917N	445	TUS9032	216	TY168	240	TY413	245	VAC5	352	VC212	336
TTT917TXN	445	TUS9035	216	TY169	244	TY414	245	VAC6	351	VC215	336
TTT6508R	454	TUS9038	216	TY170	247	TY415	245	VAC7	352	VC216	336
TTTHEX7	449	TUS9041	216	TY172	244	TY417	246	VAC8	351	VC224	332

VC230N	288	VC594	374	VC2020	344	WB14	349	WCD31	399	WQD51	405
VC234	311	VC595	374	VC2421	344	WB15	349	WCD32	399	WQD76	405
VC235	311	VC596	374	VC2440	344	WB19	401	WCD33	399	WQD103	405
VC237	311	VC600	374	VG1	398	WB19A	401	WCD34	399	WQD106	405
VC241	332	VC601	374	VG2	398	WB20	296	WCD50	408	WQD108	405
VC247	334	VC603	374	VIP10B	335	WB21	399	WCD51	409	WQD112	405
VC336	328	VC619	374	VIP10B/10	335	WB22	399	WCD52	409	WQD113	405
VC337	328	VC620	374	VIP10C	335	WB23	399	WCD61	410	WQD116	405
VC380	328	VC621	374	VIP10C/10	335	WB26	399	WCD61B	410	WQD118	405
VC380A	328	VC622	374	VIP10G	335	WB28	399	WCD62	411	WQD122	405
VC391	328	VC626	374	VIP10G/10	335	WB30	401	WCD62B	411	WQD123	405
VC392	328	VC627	374	VIP10W	335	WB31	401	WCD63	410	WQD126	405
VC393	328	VC628	374	VIP10W/10	335	WB40	347	WCD63B	410	WQD128	405
VC394	328	VC629	374	VIP13B	335	WB41	347	WCD64	411	WQD132	405
VC395	328	VC660	296	VIP13BB	335	WB42	347	WCD64B	411	WQD133	405
VC400	321	VC663	296	VIP21B	329	WB43	347	WCD65	410	WQD136	405
VC401	141, 321	VC667	348	VIP25C	329	WB49	400	WCD66	411	WQD138	405
VC402	320	VC668	348	VIP33	335	WB50	400	WCD67	410	WQD142	405
VC403	320	VC669	348	VIP35	329	WB51	400	WCD68	411	WQD150	405
VC404	320	VC670	360	VIP37	242, 329	WB54	400	WCD69	410	WQD151	405
VC405	320	VC670B	360	VIP45DG	312	WB55	400	WCD69B	410	WQD152	405
VC406	320	VC671	361	VIP45G	312	WB56	400	WCD70	411	WQD160	405
VC408	320	VC671B	361	VIP45W	312	WB57	400	WCD71	409	WQD161	405
VC410	316	VC672	360	VIP52	329	WB59	400	WCD73	409	WQD162	405
VC411	320	VC673	361	VT1	398	WB60	400	WCD79	409	WQD170	405
VC412	320	VC678	360	W		WB61	400	WCD81	409	WQD171	405
VC415	38	VC678B	360	WAF104	406	WB62	400	WCD81B	409	WR1	391
VC430	239	VC679	360	WAF106	406	WB62	400	WCD83	409	WR2	391
VC431	239	VC680	360	WAF108	406	WB65	400	WCD145/25	408	WR3	391
VC432	239	VC681	361	WAF114	406	WB66	400	WCD345/25	410	WR11	391
VC433	239	VC682	360	WAF116	406	WB67	400	WCP25	393	WR12	391
VC441	321	VC683	361	WAF118	406	WB68	400	WCP50	393	WR13	391
VC442	321	VC684	361	WAF216	403	WB69	400	WCS25	393	WR41	391
VC470	315	VC685	361	WAF218	403	WB70	400	WCS50	393	WR42	391
VC471	315	VC686	360	WAF226	403	WB71	348	WER1	402	WR43	391
VC480	315	VC687	361	WAF228	403	WB72	349	WER2	402	WR44	391
VC481	315	VC705	339	WAF424	403	WB73	348	WER3	402	WR51	391
VC482	315	VC706	339	WAF426	403	WB75	349	WER4	402	WR52	391
VC483	315	VC715	339	WAF428	403	WB76	350	WER5	402	WR53	391
VC484	315	VC750	285	WAF434	403	WB77	350	WER6	402	WR54	391
VC485	315	VC751	285	WAF436	403	WB78	350	WER7	402	WR73	392
VC486	315	VC752	285	WAF438	403	WB79	350	WER10	402	WR74	392
VC506	339	VC760	317	WAF524	403	WB80	350	WER25	402	WR75	392
VC507	339	VC842	374	WAF526	403	WB81	350	WER30	402	WR76	392
VC508	347	VC843	374	WAF528	403	WB90	296	WER31	402	WR82	391
VC509	347	VC844	374	WAF624	403	WB90H	296	WER40	402	WR83	391
VC511	347	VC845	374	WAF626	403	WB91	296	WER60	402	WRF3	391, 393
VC512	347	VC882	374	WAF628	403	WB93	296	WER80	402	WS1	380
VC519	345	VC883	374	WAF854	403	WB96	296	WER150	402	WS3	378
VC524	347	VC884	374	WAF856	403	WB107	405	WES1	402	WS4	390
VC526	347	VC885	374	WAF858	403	WB112	350, 361	WES2	402	WS5	380
VC529	347	VC886	374	WAP1	402	WB113	348	WES3	402	WS6	376
VC530	344	VC887	374	WAP2	402	WB210	399	WES21	402	WS7	376
VC534	344	VC889	374	WAP3	402	WB220	399	WES31	402	WS8	377, 390
VC535	338	VC901	326	WAP4	402	WB304	405	WGD645/25	411	WS9	392
VC537	347	VC902	326	WAP5	402	WB608	405	WIP4	269	WS10	392
VC538	347	VC906	324	WAP6	402	WB612	405	WIP5	269	WS11	392
VC539	374	VC910	324	WAP7	402	WB812	405	WIPG13	268	WS12	393
VC540	374	VC911	324	WAP120	402	WB3045	405	WIPG14	268	WS13	392
VC541	374	VC928	324	WAP240	402	WBS1	401	WIPG15	268	WS13A	392
VC542	374	VC929	324	WAP360	402	WBS3	401	WIPG16	268	WS14	392
VC553	374	VC933	324	WAP800	402	WC1	297, 348	WIPG17	268	WS14A	392
VC554	374	VC934	324	WB1	401	WC3	297, 348	WIPG18	268	WS15	383
VC555	374	VC935	324	WB1A	401	WC5	407	WIPG19	268	WS16	390
VC556	374	VC940	332	WB3	349	WC10	297	WIPG20	268	WS17	378
VC559	347	VC941	326	WB4	349	WC11	297	WIPG21	268	WS18	378
VC563	374	VC942	326	WB5	349	WC12	297	WIPG22	268	WS18C	378
VC564	374	VC945	335	WB6	349-350	WC13	297, 348	WIPG23	268	WS18S	378
VC565	374	VC951	332	WB6L	349-350	WC14	297	WIPG24	268	WS19	398
VC576	374	VC952	332	WB7L	349	WC15	297	WIPG25	268	WS20	383
VC577	374	VC955	311	WB8	349	WC16	297	WIPG26	268	WS21	347
VC578	374	VC971	326	WB9	349	WC17	297	WIPG28	268	WS22	390
VC579	374	VC972	326	WB10	401	WC18	297	WIPG30	268	WS22C	390
VC590	374	VC991	329	WB10A	401	WC19	297	WIPG32	268	WS22CA	390
VC591	374	VC994	331	WB11	350	WCD23	408	WPP1	402	WS22S	390
VC592	374	VC995	331	WB12	350	WCD24	408	WPP2	402	WS22SA	390
VC593	374	VC2010	344			WCD26	408	WPP3	402	WS23	378





WS24	377	WS322	376	WS1496	379	WSD33	404	YEFX110	501	YFIX528	499
WS27	380	WS325	376	WS1497	379	WSD34	404	YEFX115	501	YFIX529	499
WS28	380	WS326	376	WS1498	378	WSD35	404	YEFX120	501	YFIX530	499
WS29	347	WS420	377	WS1500	378, 390	WSD36	404	YEFXM1	501	YFIX531	499
WS35	377	WS400	384	WS1505	378	WSD41	404	YEFXM2	501	YFIX532	499
WS36	390	WS401	384	WS1506	378	WSD42	404	YET1	501	YFIX533	499
WS37	390	WS402	384	WS1508	378	WSD43	404	YESL52	501	YFIX534	499
WS40	376	WS403	377	WS1511	378, 390	WSD44	404	YET7	500	YFIX535	499
WS41	377	WS404	383	WS1514	379	WSD51	404	YET9	500	YHCA11	504
WS42	376	WS407	383	WS1515	379	WSD52	404	YET10	500	YHCA12	504
WS43	377	WS408	383	WS1516	378	WSD60	404	YET15	500	YHCA13	504
WS44	377	WS409	383	WS1517	378	WSD61	404	YET16	500	YHFW13	502
WS45	376	WS412	380	WS1522	379	WSD62	404	YET18	500	YHFW14	502
WS46	376	WS415	381	WS1550	379	WSD63	404	YET19	500	YHFW15	502
WS48	375	WS416	381	WS55008	386	WSD64	404	YET22	500	YHNN21	502
WS49	375	WS417W	377	WS55009	386	WSD65	404	YET23	500	YHNN22	502
WS50	381	WS417Y	377	WS55010	386	WSD70	404	YET25	500	YHNN23	502
WS51	381	WS418	385	WS55104	387	WSD71	404	YET26	500	YHRW2	502
WS53	392	WS419	385	WS55105	387	WSD72	404	YET27	500	YHRW3	502
WS54	393	WS450M	385	WS55106	387	WSD73	404	YET28	500	YHRW15	502
WS55	393	WS450L	385	WS55107	387	WSD74	404	YET29	500	YHSN22	502
WS60	393	WS450XL	385	WS55108	387	WSD81	404	YET30	500	YHSN24	502
WS61	393	WS451M	385	WS55204	387	WSD91	404	YET33	500	YHSN25	502
WS62	393	WS451L	385	WS55205	387	WSD100	403	YET34	500	YHSN56	502
WS63	393	WS451XL	385	WS55206	387	WSD101	403	YET36	500	YHSN58	502
WS64	393	WS452L	384	WS55207	387	WSD102	403	YET37	500	YHSN60	502
WS65	393	WS452XL	384	WS55208	387	WSD103	403	YET72	500	YHSP8	504
WS66	393	WS453M	384	WS55308	386	WSD110	407	YET73	500	YHSP9	504
WS67	393	WS453L	384	WS55309	386	WSD111	407	YET74	500	YHSS44	502
WS68	393	WS453XL	384	WS55310	386			YET91	500	YHSS46	502
WS70	392	WS454L	384	WS55408	386			YET92	500	YHSS50	502
WS72	392	WS454XL	384	WS55409	386	YAS4	503	YET93	500	YHSS52	502
WS74	392	WS455L	385	WS55410	386	YAS23	503	YFIX20	503	YHSS53	502
WS76	362	WS455XL	385	WS55508	387	YAS33	503	YFIX21	503	YHSS55	502
WS77	362	WS457L	385	WS55509	387	YBAT25	501	YFIX29	503	YHTK10/4	503
WS78	363	WS457XL	385	WS55510	387	YBAT32	501	YFIX31	503	YHTK10/6	503
WS84	392	WS458L	384	WS55608	387	YBN11	504	YFIX39	503	YHTK6/4	503
WS85	392	WS458M	384	WS55609	387	YBN13	504	YFIX500	498	YHTK8/6	503
WS86	392	WS458XL	384	WS55610	387	YBN46	504	YFIX501	498	YHUC3	503
WS89	392	WS459L	384	WS55708	386	YBR6	504	YFIX502	498	YHUC5	503
WS90	392	WS459XL	384	WS55709	386	YBR7	504	YFIX503	498	YJCS0	504
WS91	392	WS470	388	WS55710	386	YCHART1	161, 173, 200	YFIX504	498	YJCSOX	504
WS92	392	WS471	388	WS55808	386	YDR18	504	YFIX505	498	YJCSM00	504
WS95	380	WS472	388	WS55809	386	YDR316	504	YFIX506	498	YKIT2	496
WS101	362	WS473	388	WS55810	386	YDRM3.3	504	YFIX507	498	YLP1	504
WS105	362	WS474	388	WS55908	386	YDRM4	504	YFIX508	498	YNP3	503
WS110	362	WS475	388	WS55909	386	YDRM5	504	YFIX509	498	YNP4	503
WS120	346	WS476	388	WS55910	386	YDRM6	504	YFIX510	498	YNP6	503
WS140	346	WS477	388	WS56008	386	YEAC106	501	YFIX511	498	YNP19	503
WS160	362	WS478	388	WS56009	386	YEAC108	501	YFIX512	498	YNP33	503
WS165	362	WS500	391	WS56010	386	YEAC110	501	YFIX513	498	YNP34	503
WS170	363	WS501	391	WSB31	403	YEAC406	501	YFIX514	498	YNP35	503
WS200	363	WS502	391	WSB32	403	YECT81	501	YFIX515	498	YNP51	503
WS200R	363	WS503	391	WSB33	403	YECT82	501	YFIX516	498	YNPMP2	503
WS302	375	WS510	375	WSB51	403	YECT83	501	YFIX517	498	YPR107	503
WS303	375	WS511	375	WSB52	403	YECT84	501	YFIX518	499	YPRB11	503
WS304	375	WS512	375	WSB53	403	YECT87	501	YFIX519	499	YPRB21	503
WS305	375	WS513	375	WSD1	404	YECTG57	501	YFIX520	499	YSTAND1	496
WS306	375	WS514	375	WSD2	404	YEFD13	501	YFIX521	499	YTL662	504
WS307	375	WS515	375	WSD3	404	YEFDM1	501	YFIX522	499	YTY120	504
WS308	375	WS516	375	WSD7	404	YEFH140	501	YFIX523	499		
WS309	375	WS517	375	WSD8	404	YEFH150	501	YFIX524	499		
WS311	375	WS1491	378	WSD9	404	YEFX10	501	YFIX525	499		
WS320	376	WS1494	379	WSD31	404	YEFX15	501	YFIX526	499		
WS321	376	WS1495	379	WSD32	404	YEFX20	501	YFIX527	499		









Millimeter/Inch Conversion Chart

mm to inch conversions are to the nearest 1/32" or 1/64"
inch to mm conversions are correct to one decimal place

mm	inch
1	3/64
2	5/64
3	1/8
4	5/32
5	13/64
6	15/64
7	9/32
8	5/16
9	23/64
10	25/64
11	7/16
12	15/32
13	1/2
14	9/16
15	19/32
16	5/8
17	21/32
18	23/32
19	3/4
20	25/32
21	27/32
22	7/8
23	29/32
24	15/16
25	31/32
26	1 1/32
27	1 1/16
28	1 3/32
29	1 1/8
30	1 3/16
31	1 7/32
32	1 1/4
33	1 5/16
34	1 11/32
35	1 3/8
36	1 13/32
37	1 7/16
38	1 1/2

mm	inch
39	1 17/32
40	1 9/16
41	1 5/8
42	1 21/32
43	1 11/16
44	1 3/4
45	1 25/32
46	1 13/16
47	1 27/32
48	1 7/8
49	1 15/16
50	1 31/32
51	2
52	2 1/16
53	2 3/32
54	2 1/8
55	2 5/32
56	2 3/16
57	2 1/4
58	2 9/32
59	2 5/16
60	2 3/8
61	2 13/32
62	2 7/16
63	2 15/32
64	2 1/2
65	2 9/16
66	2 19/32
67	2 5/8
68	2 11/16
69	2 23/32
70	2 3/4
71	2 13/16
72	2 27/32
73	2 7/8
74	2 29/32
75	2 15/16
76	3

inch	mm
3/64	1.2
1/16	1.6
5/64	2.0
3/32	2.4
7/64	2.8
1/8	3.2
9/64	3.6
5/32	4.0
11/64	4.4
3/16	4.8
13/64	5.2
7/32	5.6
15/64	6.0
1/4	6.4
17/64	6.7
9/32	7.1
19/64	7.5
5/16	7.9
21/64	8.3
11/32	8.7
23/64	9.1
3/8	9.5
25/64	9.9
13/32	10.3
27/64	10.7
7/16	11.1
29/64	11.5
15/32	11.9
31/64	12.3
1/2	12.7
17/32	13.5
9/16	14.3
19/32	15.1
5/8	15.9
21/32	16.7
11/16	17.5
23/32	18.3
3/4	19.1
25/32	19.8
13/16	20.6
27/32	21.4
7/8	22.2
29/32	23.0
15/16	23.8
31/32	24.6
1	25.4
1 1/32	26.2
1 1/16	27.0
1 3/32	27.8

inch	mm
1 1/8	28.6
1 3/16	30.2
1 7/32	31.0
1 1/4	31.8
1 5/16	33.3
1 11/32	34.1
1 3/8	34.9
1 13/32	35.7
1 7/16	36.5
1 1/2	38.1
1 17/32	38.9
1 9/16	39.7
1 5/8	41.3
1 21/32	42.1
1 11/16	42.9
1 3/4	44.5
1 25/32	45.2
1 13/16	46.0
1 27/32	46.8
1 7/8	47.6
1 15/16	49.2
1 31/32	50.0
2	50.8
2 1/16	52.4
2 3/32	53.2
2 1/8	54.0
2 5/32	54.8
2 3/16	55.6
2 1/4	57.2
2 9/32	57.9
2 5/16	58.7
2 3/8	60.3
2 13/32	61.1
2 7/16	61.9
2 15/32	62.7
2 1/2	63.5
2 9/16	65.1
2 19/32	65.9
2 5/8	66.7
2 11/16	68.3
2 23/32	69.1
2 3/4	69.9
2 13/16	71.4
2 27/32	72.2
2 7/8	73.0
2 29/32	73.8
2 15/16	74.6
3	76.2

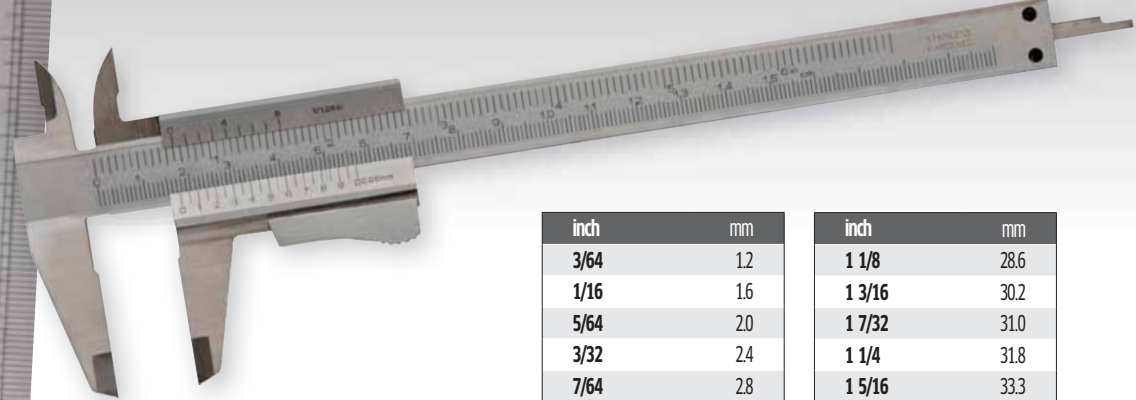

L · A · H

SUPPLIES LTD

For all your workshop consumable needs



Contact – Sales@lahsupplies.co.uk