



**RIVETING PRODUCTS**

QUALITY • SERVICE • PERFORMANCE



CATALOGUE 2024

[www.jrprivets.co.uk](http://www.jrprivets.co.uk)



# WELCOME TO JRP

QUALITY • SERVICE • PERFORMANCE

JRP (Jaton Riveting Products) is an extensive range of premium quality blind rivets, rivet nuts and setting tools, that will meet the needs of the most demanding fastening requirements.

The range has been developed with our customer's needs at the forefront. Our commitment to stock ensures the most popular types and sizes are in stock, competitively priced, for next-day delivery throughout most of the UK mainland.

The dedicated riveting range from Owlett-Jaton, JRP offers a wide range of products for use within multiple industries. Underpinned by quality, reliability and technical support, the JRP range is produced from durable, high-quality materials, to meet the exacting needs of the application.

**FREE NEXT-DAY DELIVERY, WITH LOW MINIMUM ORDER LEVELS, ACROSS THE MAJORITY OF THE UK MAINLAND.**





## UNDERPINNED BY TECHNICAL SUPPORT

Providing leading technical support, we offer the technical knowledge needed to support the range and help customers to support end users.

- JRP's dedicated technical support are on hand to offer technical advice.
- Technical data is available for all products within the range.
- JRP's after-sales service provides tooling replacement support and verification of standards.

## PERFORMANCE

The JRP range has been designed to guarantee the highest standards to provide reliability and performance. The majority of the rivet range is manufactured to DIN 7337.

**ISO 9001:2015** - All JRP products are sourced exclusively from ISO 9001 factories, and Owlett-Jaton itself is accredited to this standard.

**ISO 14001:2015** - Owlett-Jaton is committed to operating in an environmentally sustainable manner and is the first wholesaler in the industry to be awarded this certification.

**ISO TS 16949:2009** - JRP products can be supplied to meet ISO/TS 16949 by request.

**ISO 14589** - All JRP products are tested to this standard.



## APPLICATIONS

The JRP range offers innovative solutions to engineers working in differing manufacturing environments including repairs and maintenance, site work and automated production lines. Our extensive range of products ensures that we are able to offer the best solution to an application in order to meet a broad range of customer requests.

JRP rivets and rivet nuts are suitable for use in a wide range of industries including automotive, electronics and construction. They can be used to fasten a wide selection of materials including thin metals and plastics, as well as multiples of materials.

**Our sales offices are open Monday to Thursday 8.30 am to 5.30 pm and 8.30 am to 5.00 pm on Fridays.  
Account-holders can order online from [www.owlett-jaton.com](http://www.owlett-jaton.com)**

# NEW FOR 2024

Over eighty lines of rivet nuts have been added to the range, as well as two new rivet nut setting tools.



## REDUCED HEAD ROUND KNURLED BODY CLOSED BLIND RIVET NUT ●●●

For use when a "flush fit" or moisture/ pressure-tight seal is required.



## REDUCED HEAD PART HEXAGON BODY CLOSED BLIND RIVET NUT ●●●

Used when a higher torque loading is needed, but a "flush fit" or moisture/ pressure-tight seal is required.



## FLAT HEAD ROUND JK SPLIT NUT OPEN BLIND RIVET NUT ●

Ideal for use in soft or brittle materials. The legs expand on the blindside of the parent material to provide a load-bearing footprint. (Not suitable if a high torque load is required).



## FLAT HEAD ROUND PN HEAVY DUTY SPLIT NUT ●

Ideal for use in composites, plastics, GRP and thin sheet metals where very high pull-out forces are required. The legs expand on the blindside of the parent material to provide a load-bearing footprint and high torque loading.



## FLAT HEAD US ROUND KNURLED BODY OPEN BLIND RIVET NUT ●

Ideal for use in oversize holes, they have a larger body diameter than other types of rivet nuts. A thin wall also allows for a larger grip range.



## REDUCED HEAD US ROUND KNURLED BODY OPEN BLIND RIVET NUT ●

Similar to the flat head version but ideal where a "flush fit" is required without the need for a countersunk hole.

For application usage, see page 88.

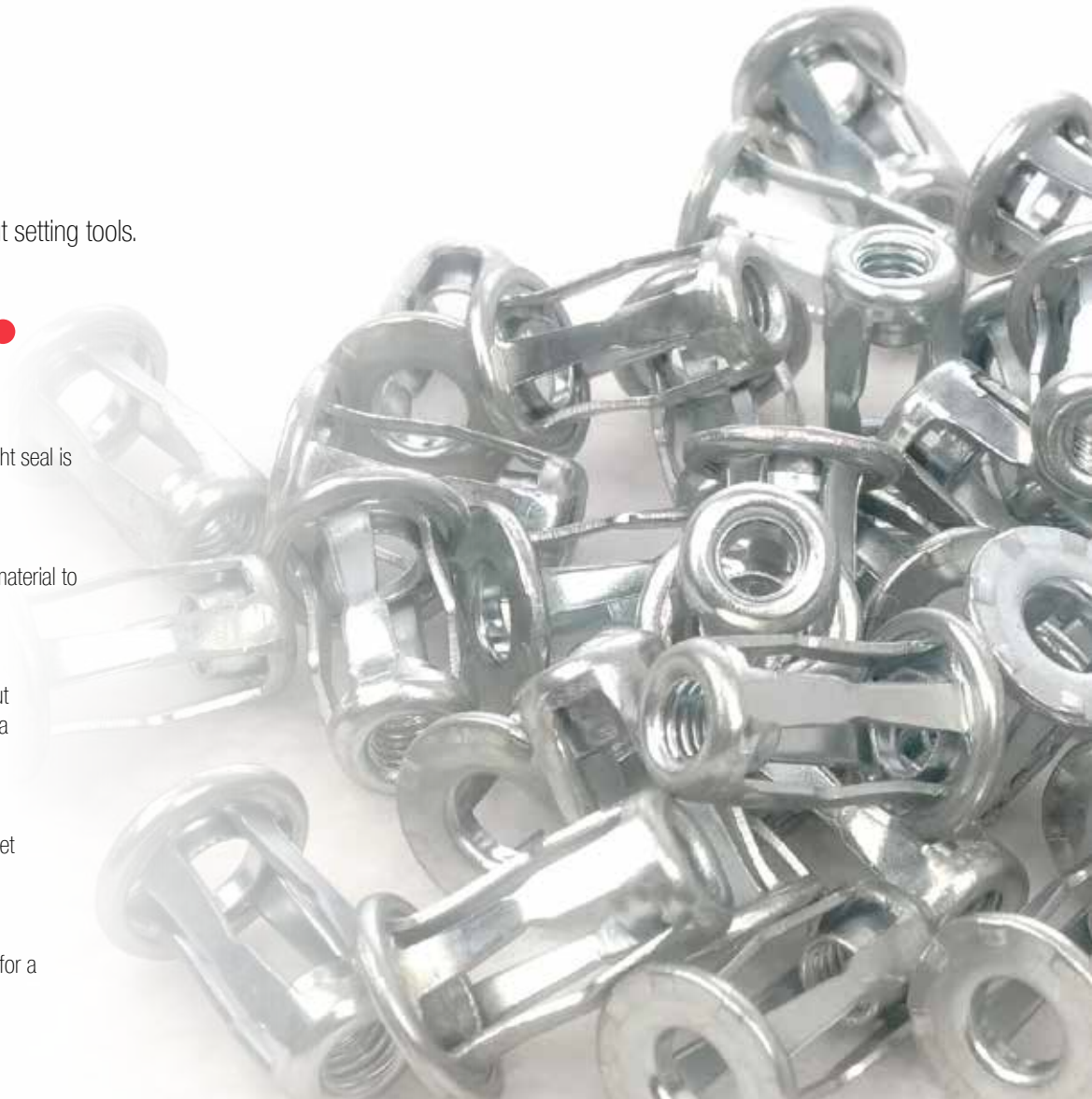

## PRODUCT FINDER

Are your customers looking to swap to JRP from another manufacturer? We have developed a tool to help you!

Due to launch 1st of April, the JRP product finder will return a JRP equivalent product when an alternative supplier code is entered.

Keep an eye out at [www.jrprivets.co.uk](http://www.jrprivets.co.uk)



# Owlett-Jaton

## The No. 1 choice for Quality, Service, and Value

Owlett-Jaton is the UK and Ireland's leading wholesale supplier of fasteners, fixings, and associated products to the distributor and merchant trade. Offering in excess of 30,000 product lines, we are also the largest stockholder in the industry.

Operating from a purpose-built warehouse in Stone, Staffordshire, our comprehensive stock line-up is backed by large stocks and efficient operations.

Our product range is the most comprehensive within our industry sector, and we understand that an important part of our offering is good stock availability, at all times. Our commitment to stock ensures products are available, competitively priced, for next-day delivery throughout most of the UK mainland.

## FREE NEXT-DAY DELIVERY, WITH LOW MINIMUM ORDER LEVELS, ACROSS THE MAJORITY OF THE UK MAINLAND.

We are the name behind some of the UK's leading fastener and fixing brands, including JCP, JRP, Thunderbolt, Unifix, and Vortex. With a comprehensive stock range in depth, volume, and continuity of supply, as well as a stock buying power that is unique to the market, we are recognised for offering a complete wholesale solution.

Our commitment to customer service and quality products is demonstrated by our ISO 9001:2015 Quality Management system. We are also dedicated to operating in an environmentally sustainable manner, and we are the first wholesaler in our industry to be awarded ISO 14001:2015 Environmental Management certification.



# CONTENTS

|                                  |   |
|----------------------------------|---|
| Merchandising the JRP Range..... | 8 |
|----------------------------------|---|

## BLIND RIVETS

|                                      |    |
|--------------------------------------|----|
| Blind Rivet Head Styles.....         | 9  |
| Blind Rivet Types.....               | 11 |
| The JRP Blind Rivet Range.....       | 12 |
| Product Suitability Guide.....       | 13 |
| Selecting The Right Blind Rivet..... | 14 |
| Technical Data.....                  | 15 |

## THE BLIND RIVETS PRODUCT RANGE

### STANDARD RIVETS

|  |    |
|--|----|
| <b>Body:</b> Aluminium <b>Mandrel:</b> Steel Zinc&Clr Tri3           |    |
| Dome Head Open Blind Rivet.....                                      | 16 |
| Dome Head Open Blind Rivet RAL 9016 Brilliant White.....             | 20 |
| Dome Head Open Blind Rivet RAL 9005 Black.....                       | 23 |
| Csk Head Open Blind Rivet.....                                       | 26 |
| Large Flange Head Open Blind Rivet.....                              | 28 |
| Large Flange Head Open Blind Rivet RAL 9005 Black.....               | 30 |
| <b>Body:</b> Aluminium <b>Mandrel:</b> Aluminium                     |    |
| Dome Head Open Blind Rivet.....                                      | 31 |
| <b>Body:</b> Steel Zinc&Clr Tri3 <b>Mandrel:</b> Steel Zinc&Clr Tri3 |    |
| Dome Head Open Blind Rivet.....                                      | 32 |
| Csk Head Open Blind Rivet.....                                       | 35 |
| Large Flange Head Open Blind Rivet.....                              | 36 |
| <b>Body:</b> Copper 110 <b>Mandrel:</b> Steel Zinc&Clr Tri3          |    |
| Dome Head Open Blind Rivet.....                                      | 37 |
| <b>Body:</b> A2 Stainless Steel <b>Mandrel:</b> A2 Stainless Steel   |    |
| Dome Head Open Blind Rivet.....                                      | 38 |
| Csk Head Open Blind Rivet.....                                       | 40 |
| Large Flange Head Open Blind Rivet.....                              | 41 |
| <b>Body:</b> A4 Stainless Steel <b>Mandrel:</b> A4 Stainless Steel   |    |
| Dome Head Open Blind Rivet.....                                      | 42 |

## MULTIGRIP RIVETS

|  |    |
|--|----|
| <b>Body:</b> Aluminium <b>Mandrel:</b> Steel Zinc&Clr Tri3           |    |
| Dome Head Multigrip Blind Rivet.....                                 | 43 |
| Dome Head Multigrip Coloured Blind Rivet.....                        | 44 |
| Csk Head Multigrip Blind Rivet.....                                  | 48 |
| Large Flange Head Multigrip Blind Rivet.....                         | 49 |
| <b>Body:</b> Aluminium <b>Mandrel:</b> A2 Stainless Steel            |    |
| Dome Head Multigrip Blind Rivet.....                                 | 50 |
| <b>Body:</b> Steel Zinc&Clr Tri3 <b>Mandrel:</b> Steel Zinc&Clr Tri3 |    |
| Dome Head Multigrip Blind Rivet.....                                 | 51 |
| Large Flange Head Multigrip Blind Rivet.....                         | 52 |
| <b>Body:</b> A2 Stainless Steel <b>Mandrel:</b> A2 Stainless Steel   |    |
| Dome Head Multigrip Blind Rivet.....                                 | 53 |

## SEALED RIVETS

|  |    |
|--|----|
| <b>Body:</b> Aluminium <b>Mandrel:</b> Steel Phosphated              |    |
| Dome Head Sealed Blind Rivet.....                                    | 54 |
| Csk Head Sealed Blind Rivet.....                                     | 55 |
| <b>Body:</b> Aluminium <b>Mandrel:</b> Aluminium                     |    |
| Dome Head Sealed Blind Rivet.....                                    | 56 |
| <b>Body:</b> Aluminium <b>Mandrel:</b> A2 Stainless Steel            |    |
| Dome Head Sealed Blind Rivet.....                                    | 57 |
| <b>Body:</b> Steel Zinc&Clr Tri3 <b>Mandrel:</b> Steel Zinc&Clr Tri3 |    |
| Dome Head Sealed Blind Rivet.....                                    | 58 |
| <b>Body:</b> A2 Stainless Steel <b>Mandrel:</b> Stainless Steel      |    |
| Dome Head Sealed Blind Rivet.....                                    | 59 |

## SPECIALIST RIVETS

|  |    |
|--|----|
| <b>Body:</b> Aluminium <b>Mandrel:</b> Steel Zinc&Clr Tri3 |    |
| Dome Head Grooved Blind Rivet.....                         | 60 |
| Dome Head Peel Blind Rivet.....                            | 61 |
| <b>Body:</b> Aluminium <b>Mandrel:</b> Aluminium           |    |
| Dome Head Load Spread Blind Rivet.....                     | 62 |

|  |    |
|--|----|
| Dome Head Load Spread/Wsh Blind Rivet.....         | 63 |
| Large Flange Head Load Spread/Wsh Blind Rivet..... | 64 |

## STRUCTURAL RIVETS

|  |    |
|--|----|
| <b>Body:</b> Aluminium <b>Mandrel:</b> Aluminium                     |    |
| Dome Head JRP-LOCK Structural Blind Rivet.....                       | 65 |
| Csk Head JRP-LOCK Structural Blind Rivet.....                        | 66 |
| Dome Head JRP-Hem Structural Blind Rivet.....                        | 67 |
| <b>Body:</b> Steel Zinc&Clr Tri3 <b>Mandrel:</b> Steel Zinc&Clr Tri3 |    |
| Dome Head JRP-Lock Structural Blind Rivet.....                       | 68 |
| Csk Head JRP-Lock Structural Blind Rivet.....                        | 69 |
| Dome Head JRP-Bulb Structural Blind Rivet.....                       | 70 |
| Dome Head JRP-Hem Structural Blind Rivet.....                        | 71 |
| <b>Body:</b> A2 Stainless Steel <b>Mandrel:</b> A2 Stainless Steel   |    |
| Dome Head JRP-Lock Structural Blind Rivet.....                       | 72 |
| Csk Head JRP-Lock Structural Blind Rivet.....                        | 73 |
| Dome Head JRP-Bulb Structural Blind Rivet.....                       | 74 |
| Dome Head JRP-Hem Structural Blind Rivet.....                        | 75 |
| <b>Body:</b> Aluminium <b>Mandrel:</b> Steel Zinc&Clr Tri3           |    |
| Dome Head Open Blind Rivet.....                                      | 78 |
| Large Flange Head Open Blind Rivet.....                              | 79 |
| Large Flange Head Open Blind Rivet RAL 9005 Black.....               | 80 |
| <b>Body:</b> Steel Zinc&Clr Tri3 <b>Mandrel:</b> Steel Zinc&Clr Tri3 |    |
| Dome Head Open Blind Rivet.....                                      | 81 |
| Dome Head JRP-Lock Structural Blind Rivet.....                       | 82 |
| <b>Body:</b> A2 Stainless Steel <b>Mandrel:</b> A2 Stainless Steel   |    |
| Dome Head Multigrip Blind Rivet.....                                 | 83 |
| Dome Head JRP-Lock Structural Blind Rivet.....                       | 84 |

## RETAIL BAGS - RIVETS



## BLIND RIVET NUTS

|  |    |
|--|----|
| Blind Rivet Nut Head Styles.....         | 86 |
| The JRP Blind Rivet Nut Range.....       | 87 |
| Blind Rivet Nut Types.....               | 88 |
| Product Suitability Guide.....           | 90 |
| Selecting The Right Blind Rivet Nut..... | 92 |
| Technical Data.....                      | 93 |

## THE BLIND RIVET NUTS PRODUCT RANGE

### Steel Zinc&Clr Tri8

|   |     |
|---|-----|
| Flat Head Round Knurled Body Open Blind Rivet Nut.....                | 94  |
| Csk Head Round Knurled Body Open Blind Rivet Nut.....                 | 95  |
| Reduced Head Round Knurled Body Open Blind Rivet Nut (Metric) ...     | 96  |
| Reduced Head Round Knurled Body Open Blind Rivet Nut (Imperial) .     | 97  |
| Flat Head Full Hexagon Body Open Blind Rivet Nut.....                 | 98  |
| Reduced Head Full Hexagon Body Open Blind Rivet Nut.....              | 99  |
| Flat Head Part Hexagon Body Open Blind Rivet Nut.....                 | 100 |
| Reduced Head Part Hexagon Body Open Blind Rivet Nut.....              | 101 |
| Flat Head Round Knurled Body Closed Blind Rivet Nut.....              | 102 |
| Csk Head Round Knurled Body Closed Blind Rivet Nut.....               | 103 |
| <b>NEW</b> Reduced Head Round Knurled Body Closed Blind Rivet Nut ..  | 104 |
| <b>NEW</b> Reduced Head Part Hexagon Body Closed Blind Rivet Nut .... | 105 |
| <b>* NEW</b> Flat Head Round JK Split Body Open Blind Rivet Nut.....  | 106 |
| <b>NEW</b> Flat Head Round PN Heavy Duty Split Body                   |     |
| Open Blind Rivet Nut.....   | 107 |
| <b>NEW</b> Flat Head Round US Knurled Body Open Blind Rivet Nut.....  | 108 |
| <b>NEW</b> Reduced Head Round US Knurled Open Body Blind Rivet Nut    | 109 |

### A2 Stainless Steel

|   |     |
|---|-----|
| Flat Head Round Knurled Body Open Blind Rivet Nut.....                | 110 |
| Csk Head Round Knurled Body Open Blind Rivet Nut.....                 | 111 |
| Reduced Head Round Knurled Body Open Blind Rivet Nut.....             | 112 |
| Flat Head Part Hexagon Body Open Blind Rivet Nut.....                 | 113 |
| Reduced Head Part Hexagon Body Open Blind Rivet Nut.....              | 114 |
| Flat Head Round Knurled Body Closed Blind Rivet Nut.....              | 115 |
| <b>NEW</b> Reduced Head Round Knurled Body Closed Blind Rivet Nut ..  | 116 |
| <b>NEW</b> Reduced Head Part Hexagon Body Closed Blind Rivet Nut .... | 117 |
| Csk Head Round Knurled Body Closed Blind Rivet Nut.....               | 118 |

### A4 Stainless Steel

|   |     |
|---|-----|
| Flat Head Round Knurled Body Open Blind Rivet Nut.....                | 119 |
| Csk Head Round Knurled Body Open Blind Rivet Nut.....                 | 120 |
| Reduced Head Round Knurled Body Open Blind Rivet Nut.....             | 121 |
| Flat Head Part Hexagon Body Open Blind Rivet Nut.....                 | 122 |
| Reduced Head Part Hexagon Body Open Blind Rivet Nut.....              | 123 |
| <b>NEW</b> Reduced Head Round Knurled Body Closed Blind Rivet Nut ..  | 124 |
| <b>NEW</b> Reduced Head Part Hexagon Body Closed Blind Rivet Nut .... | 125 |

### Aluminium

|   |     |
|---|-----|
| Flat Head Round Knurled Body Open Blind Rivet Nut.....    | 126 |
| Csk Head Round Knurled Body Open Blind Rivet Nut.....     | 127 |
| Reduced Head Round Knurled Body Open Blind Rivet Nut..... | 128 |

## HAND TOOLS

|                                 |     |
|---------------------------------|-----|
| Hand Tools Introduction.....    | 130 |
| Blind Rivet Hand Tools.....     | 131 |
| Blind Rivet Nut Hand Tools..... | 132 |
| Hand Tool Capacity Guide.....   | 135 |

## BATTERY TOOLS

|                                    |     |
|------------------------------------|-----|
| Battery Tools Introduction.....    | 138 |
| Blind Rivet Battery Tools.....     | 139 |
| Blind Rivet Nut Battery Tools..... | 141 |
| Battery Tool Capacity Guide.....   | 143 |

|  |     |
|--|-----|
| Appendix 1: Technical Data - Nuts..... | 144 |
| Customer Support Materials.....        | 145 |
| Notes.....                             | 146 |
| Terms and Conditions of Sale.....      | 147 |

### \* Steel Zinc&Clr Tri3

All prices subject to change without notice. E&OE. Data subject to change without prior notification.

Grip range and test data to be used as a guide only. All test and performance data contained within this brochure reflects the ultimate strength determined, with a small group of samples over multiple tests. We recommended that you carry out tests to determine accurate performance levels.

## WHAT IS A BLIND RIVET?

A blind rivet is a low-cost permanent fastening system designed to join two or more pieces of material together where only one side is accessible. The term 'blind rivets' comes from the fact that you are unable to see the other side. Materials can be the same or different.

A blind rivet consists of two parts: -

- The body (also referred to as the shank)
- The mandrel (sometimes called the nail or rivet stem)



The rivet mandrel is manufactured from wire in a similar process to nails. During manufacture, the rivet mandrel is crimped to produce the breakpoint, or more commonly referred to as where the rivet 'snaps' or 'pops'.

The materials for each part can be made of different materials to give a variety of combinations. The most popular combination used throughout the UK and Ireland is an aluminium body on a steel mandrel.

## WHAT IS A BLIND RIVET NUT?

A blind rivet nut, also known as a rivet nut, nut-sert or riv-nut, is a one-piece internally threaded and counterbored tubular rivet, used to create highly durable threads particularly in thin materials where only one side is accessible. A blind rivet nut can create a strong thread in:

- Thin metal sheet/profiles where thread forming is not possible
- Thick metal sheet/profiles that are too hard for thread forming
- Composite or plastic materials where no thread forming is possible
- Box sections or enclosed applications where access is restricted
- On-site repairs to damaged or stripped threads

# MERCHANDISING THE JRP RANGE

JRP products have been designed to sit together in-store as a vibrant and eye-catching range.

The JRP packaging has been designed with functionality in mind. The in-depth label information helps assist customers in choosing the right product for their requirements.

We have many different merchandising standards available to display the JRP range.

**Contact us to find out more.**



See page 76 for more information.

QUALITY • SERVICE • PERFORMANCE







**RIVETS**

# BLIND RIVET HEAD STYLES

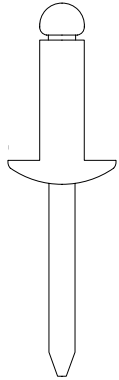

## DOME HEAD

The dome head is the most common and multifunctional head style. By providing a large bearing surface they can retain most materials, except those which are very smooth or brittle. A dome head blind rivet can be used in a conventional way of fixing or for multiple materials.

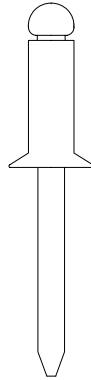
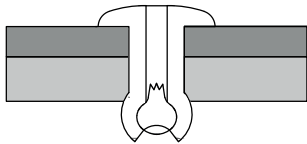

## COUNTERSUNK HEAD

The countersunk head is used where a flush or non-interference fit is required. Due to the larger grip range available, it is suitable for riveting through a larger range of thicknesses.

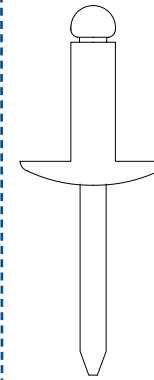
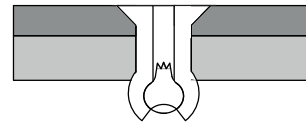

## LARGE FLANGE HEAD

The large flange head is extensively used where a greater surface area is required and offers excellent resistance. Providing double the coverage of the dome head, this head type offers the largest bearing surface available. Designed for applications when there may be dissimilar metals, where one is softer than the setting material, or some plastics. A large flange blind rivet can be used in a conventional way of fixing or for multiple materials.

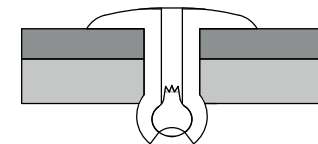

# MATERIALS INDEX



Aluminium



Steel



A2 Stainless Steel



A4 Stainless Steel



Copper



# BLIND RIVET TYPES

## STANDARD

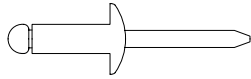

The most common and widely used rivet range, available in dome head, countersunk and large flange head types. Available in many materials, it is used in a multitude of industries such as aerospace, automotive, rail, HVAC, white goods, electronics, DIY and general engineering.



## MULTIGRIP



Similar to a standard rivet, but with an even wider grip range - ideal to reduce inventory. Only four sizes cover a thickness range of 0.5mm to 24mm. Best suited for use with soft materials, plastics and thin sheet metal. Particularly useful in secondary or irregular holes. They are used for the same applications as standard rivets, as well as roofing, windows, cladding and construction.



## SEALED\*

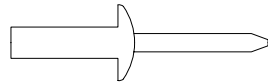

Sealed rivets provide 100% mandrel tension and eliminate any leakage of liquids or gases. This style of rivet is best suited where a moisture or pressure-tight seal is required. They are most commonly used in white goods, electrical enclosures, indoor and outdoor electronic signs, automotive, aerospace, rail and HVAC. *\*Incorrect hole preparation will result in failure of sealing properties.*



## SPECIALIST 1. PEEL

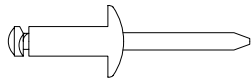

Comparable to multigrip, the peel rivet spreads the load and fastening strength over a wide area, making them suitable for use in soft materials such as plastics, PVCu, and thin sheet metal. Again, they can be used in oversized holes with a wide grip range and can be set easily in confined spaces. They are predominantly used in the glazing industry, but can also be used in roofing, cladding and insulation.



## 2. GROOVED

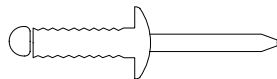

Ideally suited for fixing metal to wood, plastic, cement and brick. The grooved rivet body is designed to 'bite' into the material upon setting. They are most commonly used in flight cases, plastic cases and construction.



## 3. LOAD SPREAD

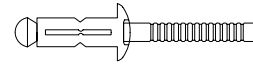

Similar to multigrip and peel rivets, load spread rivets are particularly suited to softer materials and thin sheet metals. They offer a wide grip range with excellent load spread setting and a mandrel locking system. They are used predominantly in modular buildings, portable wash facilities and plastic pallet and storage solutions.



## 4. LOAD SPREAD WITH WASHER

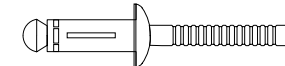

Same as a load spread rivet, but with added sealing properties provided by an EPDM washer. These can be used on radial surfaces. Ideally suited for fall arrest systems, roofing and cladding.



## STRUCTURAL 1. JRP-LOCK

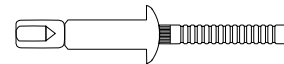

Specifically designed to meet applications where high shear and tensile strengths are required in the most demanding of applications. Structural rivets offer high clamping properties to assist with moisture and pressure type applications. Quick and easy to install, they offer fastening longevity. Structural rivets are used in a multitude of industries such as aerospace, rail, HVAC, white goods, electronics, commercial vehicles and general engineering.



## 2. JRP-BULB

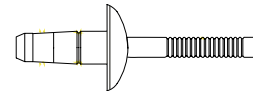

Specifically designed with a high shear and tensile strength. Provides a large blind side bearing area with a retained mandrel causing no damage, electrical problems or rattling due to loose stems. Ideal for use in thin sheet materials they compensate for irregular, oversized, slotted or misaligned holes and can stop movement due to their hole fill properties. Strong and vibration resistant joints even with elevated temperatures. Used in a multitude of industries such as automotive, aerospace, rail, HVAC, marine, food processing, electronics, medical equipment and street furniture.



## 3. JRP-HEM

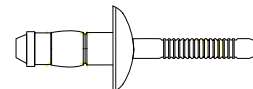

Specifically designed with an exceptionally high shear and tensile strength. Provides a large blind side bearing area with a mechanically locked mandrel. Ideal for use in thin sheet materials as well as metal/plastic assemblies, they compensate for irregular, oversized, slotted or misaligned holes and can stop movement due to their hole fill properties. Exceptionally strong and vibration resistant joints even with elevated temperatures. Used in a multitude of industries such as automotive, aerospace, rail, HVAC, marine, vibratory equipment, electronics, warehouse racking systems and ladders.



# THE JRP BLIND RIVET RANGE

| JRP <sup>®</sup><br>RIVETING PRODUCTS | Body  | Aluminium | Aluminium | Aluminium          | Steel   | Copper  | A2 Stainless Steel | A4 Stainless Steel |
|---------------------------------------|---|-----------|-----------|--------------------|---------|---------|--------------------|--------------------|
|                                       | Mandrel                                     | Steel     | Aluminium | A2 Stainless Steel | Steel   | Steel   | A2 Stainless Steel | A4 Stainless Steel |
| <b>STANDARD</b>                       | Dome Head Open Blind Rivet                  | 2.4-6.4   | 3.2-4.8   |                    | 3.0-6.4 | 3.2-4.8 | 3.2-6.4            | 3.2-4.8            |
|                                       | Dome Head RAL 9016 Open Blind Rivet         | 2.4-4.8   |           |                    |         |         |                    |                    |
|                                       | Dome Head RAL 9005 Open Blind Rivet         | 2.4-4.8   |           |                    |         |         |                    |                    |
|                                       | Csk Head Open Blind Rivet                   | 2.4-4.8   |           |                    | 3.0-4.8 |         | 3.2-4.8            |                    |
|                                       | Large Flange Head Open Blind Rivet          | 3.2-4.8   |           |                    | 4.8     |         | 3.2-4.8            |                    |
|                                       | Large Flange Head RAL 9005 Open Blind Rivet | 3.2-4.8   |           |                    |         |         |                    |                    |
| <b>MULTIGRIP</b>                      | Dome Head Multigrip Blind Rivet             | 3.0-4.8   |           | 3.2-4.8            | 3.2-4.8 |         | 3.2-6.4            |                    |
|                                       | Dome Head Coloured Multigrip Blind Rivet    | 4.8       |           |                    |         |         |                    |                    |
|                                       | Csk Head Multigrip Blind Rivet              | 3.2-4.8   |           |                    |         |         |                    |                    |
|                                       | Large Flange Head Multigrip Blind Rivet     | 3.2-4.8   |           | 4.8                | 4.8     |         |                    |                    |
| <b>SEALED</b>                         | Dome Head Sealed Blind Rivet                | 3.2-6.4   | 3.2-4.8   | 3.2-4.8            | 3.2-4.8 | 3.2-4.8 | 3.2-6.4            |                    |
|                                       | Csk Head Sealed Blind Rivet                 | 3.2-4.8   |           |                    |         |         |                    |                    |
| <b>SPECIALIST</b>                     | Dome Head Grooved Blind Rivet               | 3.2-4.8   |           |                    |         |         |                    |                    |
|                                       | Dome Head Peel Blind Rivet                  | 3.2-4.8   |           |                    |         |         |                    |                    |
|                                       | Dome Head Load Spread Blind Rivet           |           | 4.0-4.8   |                    |         |         |                    |                    |
|                                       | Dome Head Load Spread/Wsh Blind Rivet       |           | 5.2-7.8   |                    |         |         |                    |                    |
|                                       | Flange Head Load Spread/Wsh Blind Rivet     |           | 7.8       |                    |         |         |                    |                    |
| <b>STRUCTURAL</b>                     | Dome Head JRP-LOCK Structural Blind Rivet   |           | 4.8-6.4   |                    | 4.8-9.8 |         | 4.8-6.4            |                    |
|                                       | Csk Head JRP-LOCK Structural Blind Rivet    |           | 4.8-6.4   |                    | 4.8-6.4 |         | 4.8-6.4            |                    |
|                                       | Dome Head JRP-Bulb Structural Blind Rivet   |           |           |                    | 3.2-4.8 |         | 3.2-4.8            |                    |
|                                       | Dome Head JRP-Hem Structural Blind Rivet    |           | 4.8-6.4   |                    | 4.8-6.4 |         | 4.8-6.4            |                    |

Data = Nominal Diameter Range

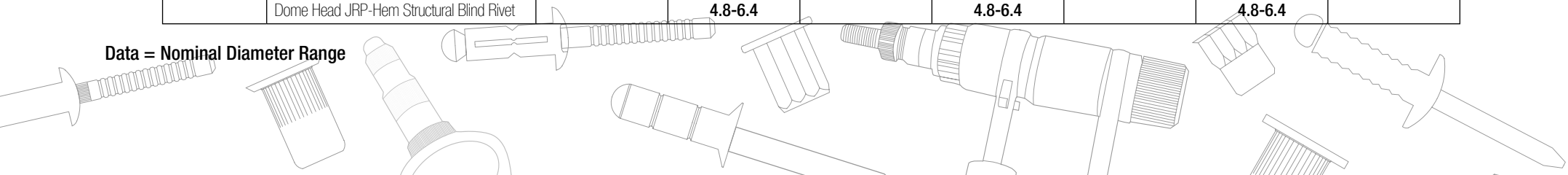



# PRODUCT SUITABILITY GUIDE

| RIVET TYPE              | Aerospace | Automotive | Rail | HVAC | White Goods | Electrical Enclosures | Electronic Signs | Electronics | General Engineering | DIY | Glazing | Roofing | Windows | Cladding | Secondary or Irregular Holes | Insulation | Construction | Flight Cases | Modular Buildings | Storage Solutions | Fall Arrest Systems | Commercial Vehicles | Marine | Medical Equipment |
|-------------------------|-----------|------------|------|------|-------------|-----------------------|------------------|-------------|---------------------|-----|---------|---------|---------|----------|------------------------------|------------|--------------|--------------|-------------------|-------------------|---------------------|---------------------|--------|-------------------|
| Standard*               |           |            |      |      |             |                       |                  |             |                     |     |         |         |         |          |                              |            |              |              |                   |                   |                     |                     |        |                   |
| Sealed                  |           |            |      |      |             |                       |                  |             |                     |     |         |         |         |          |                              |            |              |              |                   |                   |                     |                     |        |                   |
| Multigrip*              |           |            |      |      |             |                       |                  |             |                     |     |         |         |         |          |                              |            |              |              |                   |                   |                     |                     |        |                   |
| Peel                    |           |            |      |      |             |                       |                  |             |                     |     |         |         |         |          |                              |            |              |              |                   |                   |                     |                     |        |                   |
| Grooved                 |           |            |      |      |             |                       |                  |             |                     |     |         |         |         |          |                              |            |              |              |                   |                   |                     |                     |        |                   |
| Load Spread             |           |            |      |      |             |                       |                  |             |                     |     |         |         |         |          |                              |            |              |              |                   |                   |                     |                     |        |                   |
| Load Spread with Washer |           |            |      |      |             |                       |                  |             |                     |     |         |         |         |          |                              |            |              |              |                   |                   |                     |                     |        |                   |
| JRP-Lock                |           |            |      |      |             |                       |                  |             |                     |     |         |         |         |          |                              |            |              |              |                   |                   |                     |                     |        |                   |
| JRP-Bulb                |           |            |      |      |             |                       |                  |             |                     |     |         |         |         |          |                              |            |              |              |                   |                   |                     |                     |        |                   |
| JRP-Hem                 |           |            |      |      |             |                       |                  |             |                     |     |         |         |         |          |                              |            |              |              |                   |                   |                     |                     |        |                   |

\* Any RAL or BS specification colours not listed are available to order subject to MOQ's.

 = Ideal for this application



# SELECTING THE RIGHT BLIND RIVET

**A user must take into account a number of considerations when choosing the right rivet to use. We have put together some guidance to help you as a supplier, advise your customers how to select the right fastener for their application.**

## **MATERIAL CHOICE**

Both the rivet and the materials to be fastened will affect the ultimate joint strength. The rivet body material selection would generally be the same as the material(s) being assembled, i.e. an aluminium body into an aluminium section. A marked dissimilarity of materials may cause joint failure due either to material fatigue or galvanic corrosion. Stainless steel rivets offer best anti-corrosion performance.

## **RIVET HEAD STYLE**

The low-profile dome head rivet is appropriate for most applications. However, when soft or brittle materials are fastened to a rigid backing member, the large flange head rivet should be considered, to spread the load over a greater surface area. Where a flush surface is required, the countersunk head rivet style should be selected.

## **HOLE SIZE**

Hole size can be important in blind riveting. Too small a hole will, of course, make rivet insertion difficult and conversely too big a hole will cause a rivet to fail. Best practice is to accurately follow the hole size recommendations provided in the technical data.

## **JOINT THICKNESS (GRIP RANGE)**

Firstly, measure the total thickness of the materials to be joined. This will determine the required "grip" of the rivet. Refer to the "Grip Range" column in the technical data, and select a rivet with a grip range that includes the thickness required. Please note that insufficient rivet length will not allow the proper formation of the secondary head at the back of the work and could result in rivet failure.

## **RIVET JOINT STRENGTH**

The single-joint tensile and shear values vary from application to application. The functions of total joint strength, fastener spacing, rivet body material and rivet diameter are all factors that result in the final shear and tensile strengths required. Structural rivets offer the ultimate in shear and tensile strengths. Refer to the technical data supplied for typical strength values.

**The above information should be used in conjunction with the technical data found on pages 16 to 84 for the individual ranges of JRP rivets.**



# TECHNICAL DATA

## HOW TO MEASURE A BLIND RIVET

**DOME HEAD AND LARGE FLANGE HEAD** - the rivet body length (L) is always measured from under the head to the end of the body.

D = body diameter  
L = body length  
 $d^k$  = rivet head diameter  
K = rivet head thickness  
 $d^m$  = mandrel diameter  
 $L^2$  = minimum mandrel length

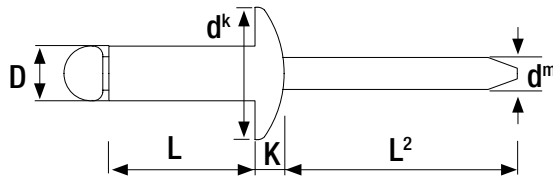

**COUNTERSUNK HEAD** - the rivet body length (L) is always measured from the top of the head to the end of the body.

D = body diameter  
L = body length  
 $d^k$  = rivet head diameter  
K = rivet head thickness  
 $d^m$  = mandrel diameter  
 $L^2$  = minimum mandrel length

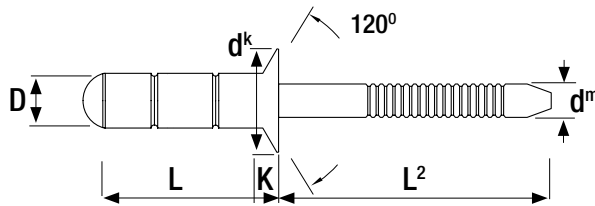

## HOW TO INSTALL A BLIND RIVET

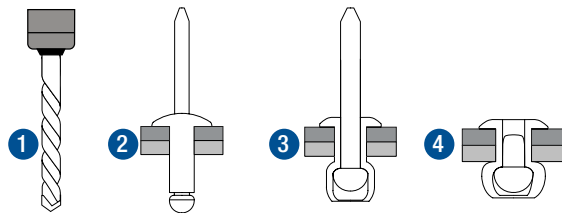

- 1 Firstly drill the hole.
- 2 To set a rivet, the rivet is placed into the setting tool and then into a pre-drilled hole. It is fixed by the jaws within the tool pulling the mandrel head into the rivet body, expanding the body and causing it to flare against the reverse (blind) side of the application.
- 3 As the head of the mandrel reaches the face of the blind side material, the mandrel will snap at the break point of the mandrel when it has reached its predetermined breaking force.
- 4 A tight joint is formed as the rivet body remains, gripping the material and encapsulating the head of the mandrel within.

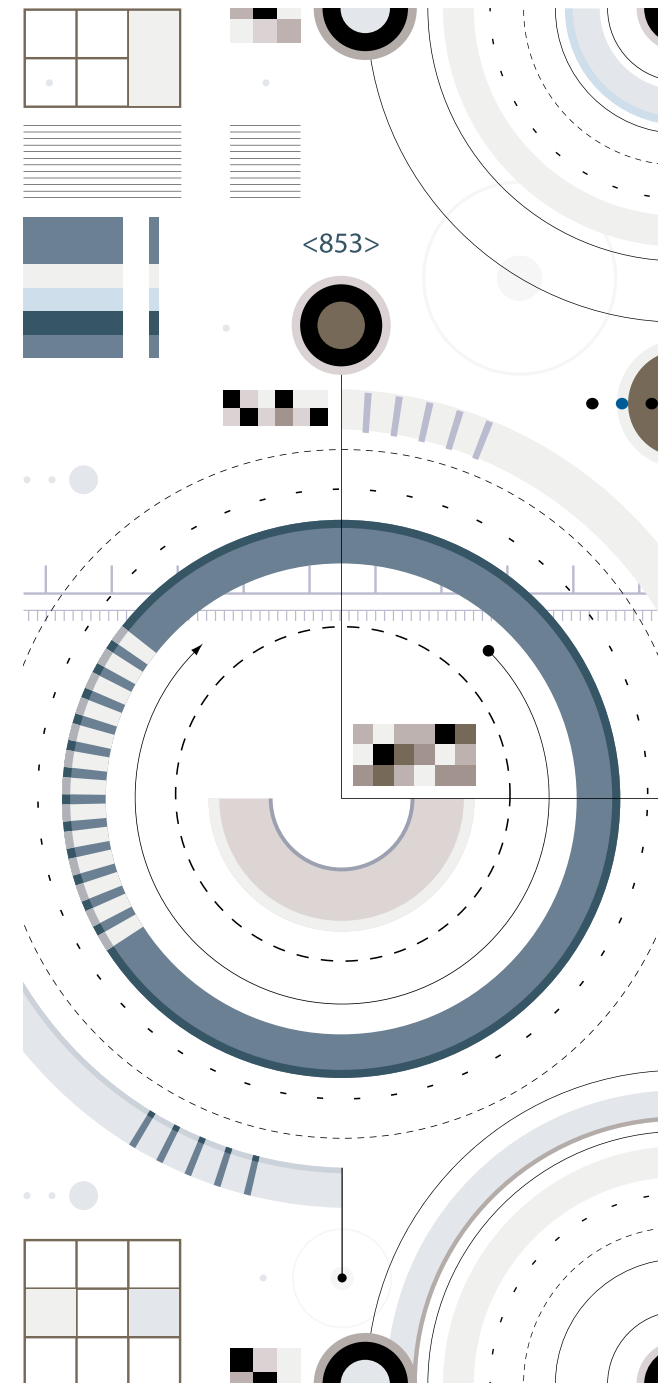



# DOME HEAD OPEN BLIND RIVET

● **BODY:** Aluminium (AlMg2.5)

● **MANDREL:** Steel Zinc&Clr Tri3

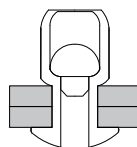
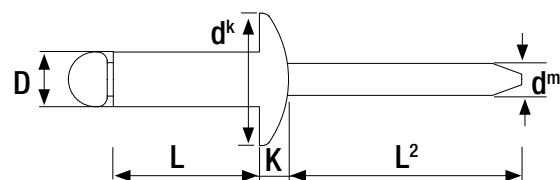

| Nominal Diameter mm (D) | Article Number | Body Length mm (L) | Grip Range Min mm | Grip Range Max mm | Hole Size mm | Flange Diameter mm (d <sup>k</sup> ) | Flange Thickness mm (K) | Nom. Mandrel Diameter mm (d <sup>m</sup> ) | Min Mandrel Length mm (L <sup>2</sup> ) | Shear Strength N | Tensile Strength N | Box Quantity | Price £ Per 1000 |
|-------------------------|----------------|--------------------|-------------------|-------------------|--------------|--------------------------------------|-------------------------|--|---|------------------|--------------------|--------------|------------------|
| 2.4                     | OJASD2404      | 4.0                | 0.5               | 2.0               | 2.5          | 5.0                                  | 0.7                     | 1.45                                       | 26.0                                    | 315              | 355                | 1000         | £14.19           |
|                         | OJASD2406      | 6.0                | 1.5               | 3.5               |              |                                      |                         |  |   |                  |                    | 1000         | £14.38           |
|                         | OJASD2408      | 8.0                | 3.5               | 5.5               |              |                                      |                         |  |   |                  |                    | 1000         | £14.69           |
|                         | OJASD2410      | 10.0               | 5.5               | 7.5               |              |                                      |                         |  |   |                  |                    | 1000         | £15.36           |
|                         | OJASD2412      | 12.0               | 7.5               | 9.5               |              |                                      |                         |  |   |                  |                    | 1000         | £16.57           |
| 3.0                     | OJASD3004      | 4.0                | 0.5               | 1.5               | 3.1          | 6.5                                  | 0.8                     | 1.75                                       | 26.0                                    | 620              | 810                | 1000         | £12.27           |
|                         | OJASD3006      | 6.0                | 1.5               | 3.5               |              |                                      |                         |  |   |                  |                    | 1000         | £12.46           |
|                         | OJASD3008      | 8.0                | 3.5               | 5.5               |              |                                      |                         |  |   |                  |                    | 1000         | £13.17           |
|                         | OJASD3010      | 10.0               | 5.5               | 7.0               |              |                                      |                         |  |   |                  |                    | 1000         | £13.66           |
|                         | OJASD3012      | 12.0               | 7.0               | 9.0               |              |                                      |                         |  |   |                  |                    | 1000         | £14.51           |
|                         | OJASD3014      | 14.0               | 9.0               | 11.0              |              |                                      |                         |  |   |                  |                    | 1000         | £15.95           |
|                         | OJASD3016      | 16.0               | 11.0              | 12.5              |              |                                      |                         |  |   |                  |                    | 800          | £17.42           |
|                         | OJASD3018      | 18.0               | 13.0              | 14.5              |              |                                      |                         |  |   |                  |                    | 800          | £18.38           |
|                         | OJASD3020      | 20.0               | 14.5              | 16.5              |              |                                      |                         |  |   |                  |                    | 500          | £20.12           |
| 3.2                     | OJASD3204      | 4.0                | 0.5               | 1.5               | 3.3          | 6.5                                  | 0.8                     | 1.75                                       | 26.0                                    | 760              | 980                | 1000         | £12.33           |
|                         | OJASD3206      | 6.0                | 1.5               | 3.0               |              |                                      |                         |  |   |                  |                    | 1000         | £12.66           |
|                         | OJASD3208      | 8.0                | 3.0               | 5.0               |              |                                      |                         |  |   |                  |                    | 1000         | £13.20           |
|                         | OJASD3210      | 10.0               | 5.0               | 7.0               |              |                                      |                         |  |   |                  |                    | 1000         | £13.47           |
|                         | OJASD3212      | 12.0               | 7.0               | 9.0               |              |                                      |                         |  |   |                  |                    | 750          | £17.16           |
|                         | OJASD3214      | 14.0               | 9.0               | 11.0              |              |                                      |                         |  |   |                  |                    | 1000         | £16.08           |
|                         | OJASD3216      | 16.0               | 11.0              | 12.5              |              |                                      |                         |  |   |                  |                    | 800          | £19.87           |
|                         | OJASD3218      | 18.0               | 12.5              | 14.5              |              |                                      |                         |  |   |                  |                    | 700          | £18.80           |
|                         | OJASD3220      | 20.0               | 14.5              | 16.5              |              |                                      |                         |  |   |                  |                    | 500          | £20.00           |
|                         | OJASD3225      | 25.0               | 17.0              | 21.0              |              |                                      |                         |  |   |                  |                    | 500          | £24.36           |

Also available in retail bags. See page 78.



# DOME HEAD OPEN BLIND RIVET

- **BODY:** Aluminium (AlMg3.5)
- **MANDREL:** Steel Zinc&Clr Tri3

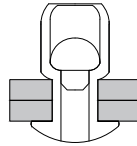
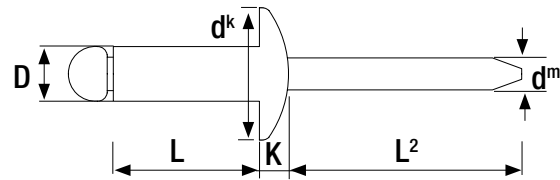

| Nominal Diameter mm (D) | Article Number | Body Length mm (L) | Grip Range Min mm | Grip Range Max mm | Hole Size mm | Flange Diameter mm (d <sup>k</sup> ) | Flange Thickness mm (K) | Nom. Mandrel Diameter mm (d <sup>m</sup> ) | Min Mandrel Length mm (L <sup>2</sup> ) | Shear Strength N | Tensile Strength N | Box Quantity | Price £ Per 1000 |
|-------------------------|----------------|--------------------|-------------------|-------------------|--------------|--------------------------------------|-------------------------|--|---|------------------|--------------------|--------------|------------------|
| 4.0                     | OJASD4006      | 6.0                | 1.0               | 2.0               | 4.1          | 8.0                                  | 1.0                     | 2.10                                       | 27.0                                    | 1200             | 1600               | 1000         | £17.38           |
|                         | OJASD4008      | 8.0                | 2.0               | 4.0               |              |                                      |                         |  |   |                  |                    | 750          | £17.09           |
|                         | OJASD4010      | 10.0               | 4.0               | 6.0               |              |                                      |                         |  |   |                  |                    | 500          | £18.38           |
|                         | OJASD4012      | 12.0               | 6.0               | 8.0               |              |                                      |                         |  |   |                  |                    | 500          | £19.97           |
|                         | OJASD4014      | 14.0               | 8.0               | 10.0              |              |                                      |                         |  |   |                  |                    | 500          | £23.61           |
|                         | OJASD4016      | 16.0               | 10.0              | 12.0              |              |                                      |                         |  |   |                  |                    | 500          | £23.97           |
|                         | OJASD4018      | 18.0               | 12.0              | 14.0              |              |                                      |                         |  |   |                  |                    | 500          | £25.02           |
|                         | OJASD4020      | 20.0               | 14.0              | 15.5              |              |                                      |                         |  |   |                  |                    | 500          | £27.82           |
|                         | OJASD4025      | 25.0               | 18.0              | 20.0              |              |                                      |                         |  |   |                  |                    | 350          | £41.03           |
| OJASD4030               | 30.0           | 21.5               | 26.0              | 250               | £52.58       |                                      |                         |  |   |                  |                    |              |                  |
| 4.8                     | OJASD4806      | 6.0                | 1.0               | 2.0               | 4.9          | 9.5                                  | 1.1                     | 2.70                                       | 28.0                                    | 1700             | 2250               | 500          | £25.73           |
|                         | OJASD4808      | 8.0                | 2.0               | 3.5               |              |                                      |                         |  |   |                  |                    | 500          | £25.20           |
|                         | OJASD4810      | 10.0               | 3.5               | 5.5               |              |                                      |                         |  |   |                  |                    | 500          | £25.68           |
|                         | OJASD4812      | 12.0               | 5.5               | 7.5               |              |                                      |                         |  |   |                  |                    | 500          | £27.44           |
|                         | OJASD4814      | 14.0               | 7.5               | 9.5               |              |                                      |                         |  |   |                  |                    | 500          | £32.62           |
|                         | OJASD4816      | 16.0               | 9.0               | 11.0              |              |                                      |                         |  |   |                  |                    | 500          | £35.15           |
|                         | OJASD4818      | 18.0               | 11.0              | 13.0              |              |                                      |                         |  |   |                  |                    | 250          | £37.98           |
|                         | OJASD4820      | 20.0               | 13.0              | 15.0              |              |                                      |                         |  |   |                  |                    | 250          | £38.56           |
|                         | OJASD4822      | 22.0               | 15.0              | 17.0              |              |                                      |                         |  |   |                  |                    | 250          | £43.05           |



Grip range and test data are guide figures only

# DOME HEAD OPEN BLIND RIVET

- **BODY:** Aluminium (AMg3.5)
- **MANDREL:** Steel Zinc&Clr Tri3

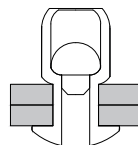
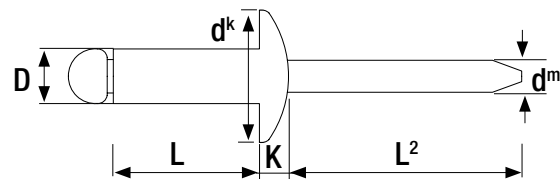

| Nominal Diameter mm (D) | Article Number | Body Length mm (L) | Grip Range Min mm | Grip Range Max mm | Hole Size mm | Flange Diameter mm (d <sup>k</sup> ) | Flange Thickness mm (K) | Nom. Mandrel Diameter mm (d <sup>m</sup> ) | Min Mandrel Length mm (L <sup>2</sup> ) | Shear Strength N | Tensile Strength N | Box Quantity | Price £ Per 1000 |
|-------------------------|----------------|--------------------|-------------------|-------------------|--------------|--------------------------------------|-------------------------|--|---|------------------|--------------------|--------------|------------------|
| 4.8                     | OJASD4825      | 25.0               | 17.0              | 20.0              | 4.9          | 9.5                                  | 1.1                     | 2.70                                       | 28.0                                    | 1700             | 2250               | 250          | £48.22           |
|                         | OJASD4828      | 28.0               | 20.0              | 23.0              |              |                                      |                         |  |   |                  |                    | 200          | £53.12           |
|                         | OJASD4830      | 30.0               | 23.0              | 24.5              |              |                                      |                         |  |   |                  |                    | 200          | £56.71           |
|                         | OJASD4835      | 35.0               | 24.5              | 29.0              |              |                                      |                         |  |   |                  |                    | 150          | £60.61           |
|                         | OJASD4840      | 40.0               | 30.0              | 35.0              |              |                                      |                         |  |   |                  |                    | 150          | £88.30           |
| 5.0                     | OJASD5006      | 6.0                | 1.0               | 2.0               | 5.1          | 9.5                                  | 1.1                     | 2.70                                       | 28.0                                    | 2000             | 2800               | 500          | £27.10           |
|                         | OJASD5008      | 8.0                | 2.0               | 3.5               |              |                                      |                         |  |   |                  |                    | 500          | £25.98           |
|                         | OJASD5010      | 10.0               | 3.5               | 5.5               |              |                                      |                         |  |   |                  |                    | 500          | £26.50           |
|                         | OJASD5012      | 12.0               | 5.5               | 7.5               |              |                                      |                         |  |   |                  |                    | 500          | £28.27           |
|                         | OJASD5014      | 14.0               | 7.5               | 9.5               |              |                                      |                         |  |   |                  |                    | 500          | £33.39           |
|                         | OJASD5016      | 16.0               | 9.0               | 11.0              |              |                                      |                         |  |   |                  |                    | 250          | £36.11           |
|                         | OJASD5018      | 18.0               | 11.0              | 13.0              |              |                                      |                         |  |   |                  |                    | 250          | £38.69           |
|                         | OJASD5020      | 20.0               | 13.0              | 15.0              |              |                                      |                         |  |   |                  |                    | 250          | £39.34           |
|                         | OJASD5025      | 25.0               | 15.0              | 20.0              |              |                                      |                         |  |   |                  |                    | 250          | £49.18           |
|                         | OJASD5030      | 30.0               | 23.0              | 24.5              |              |                                      |                         |  |   |                  |                    | 250          | £57.89           |
|                         | OJASD5035      | 35.0               | 24.5              | 29.0              |              |                                      |                         |  |   |                  |                    | 150          | £58.01           |
|                         | OJASD5040      | 40.0               | 30.0              | 35.0              |              |                                      |                         |  |   |                  |                    | 150          | £92.59           |





# DOME HEAD OPEN BLIND RIVET

- **BODY:** Aluminium (AlMg3.5)
- **MANDREL:** Steel Zinc&Clr Tri3

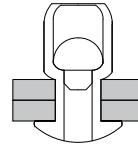
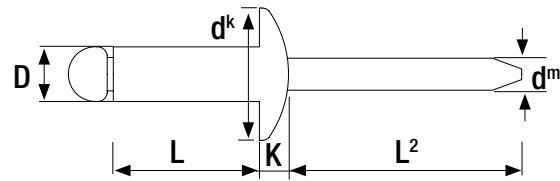

| Nominal Diameter mm (D) | Article Number | Body Length mm (L) | Grip Range Min mm | Grip Range Max mm | Hole Size mm | Flange Diameter mm (d <sup>k</sup> ) | Flange Thickness mm (K) | Nom. Mandrel Diameter mm (d <sup>m</sup> ) | Min Mandrel Length mm (L <sup>2</sup> ) | Shear Strength N | Tensile Strength N | Box Quantity | Price £ Per 1000 |
|-------------------------|----------------|--------------------|-------------------|-------------------|--------------|--------------------------------------|-------------------------|--|---|------------------|--------------------|--------------|------------------|
| 6.0                     | OJASD6008      | 8.0                | 1.0               | 3.0               | 6.1          | 12.0                                 | 1.5                     | 3.60                                       | 30.0                                    | 3000             | 3800               | 250          | £58.95           |
|                         | OJASD6010      | 10.0               | 3.0               | 4.5               |              |                                      |                         |  |   |                  |                    | 250          | £65.21           |
|                         | OJASD6012      | 12.0               | 4.5               | 6.0               |              |                                      |                         |  |   |                  |                    | 250          | £66.24           |
|                         | OJASD6014      | 14.0               | 6.0               | 8.5               |              |                                      |                         |  |   |                  |                    | 250          | £72.58           |
|                         | OJASD6016      | 16.0               | 8.5               | 10.5              |              |                                      |                         |  |   |                  |                    | 250          | £74.64           |
|                         | OJASD6018      | 18.0               | 10.5              | 12.0              |              |                                      |                         |  |   |                  |                    | 250          | £86.89           |
|                         | OJASD6020      | 20.0               | 12.0              | 14.0              |              |                                      |                         |  |   |                  |                    | 250          | £91.20           |
|                         | OJASD6022      | 22.0               | 12.0              | 16.0              |              |                                      |                         |  |   |                  |                    | 200          | £97.54           |
|                         | OJASD6026      | 26.0               | 16.0              | 20.0              |              |                                      |                         |  |   |                  |                    | 200          | £111.65          |
| OJASD6030               | 30.0           | 20.0               | 23.0              | 150               | £113.68      |                                      |                         |  |   |                  |                    |              |                  |
| 6.4                     | OJASD6410      | 10.0               | 1.0               | 3.5               | 6.5          | 13.0                                 | 1.8                     | 3.85                                       | 32.0                                    | 3150             | 4100               | 250          | £55.90           |
|                         | OJASD6412      | 12.0               | 3.5               | 5.5               |              |                                      |                         |  |   |                  |                    | 250          | £57.42           |
|                         | OJASD6415      | 15.0               | 5.5               | 8.5               |              |                                      |                         |  |   |                  |                    | 200          | £65.84           |
|                         | OJASD6418      | 18.0               | 8.5               | 11.5              |              |                                      |                         |  |   |                  |                    | 200          | £72.85           |
|                         | OJASD6420      | 20.0               | 11.0              | 13.5              |              |                                      |                         |  |   |                  |                    | 200          | £82.21           |
|                         | OJASD6422      | 22.0               | 11.5              | 15.5              |              |                                      |                         |  |   |                  |                    | 200          | £84.03           |
|                         | OJASD6426      | 26.0               | 15.5              | 19.0              |              |                                      |                         |  |   |                  |                    | 100          | £98.77           |
|                         | OJASD6430      | 30.0               | 19.0              | 23.0              |              |                                      |                         |  |   |                  |                    | 100          | £106.53          |
|                         | OJASD6435      | 35.0               | 23.0              | 28.0              |              |                                      |                         |  |   |                  |                    | 100          | £117.96          |
|                         | OJASD6440      | 40.0               | 28.0              | 33.0              |              |                                      |                         |  |   |                  |                    | 100          | £164.06          |

Grip range and test data are guide figures only

# DOME HEAD OPEN BLIND RIVET RAL 9016 BRILLIANT WHITE

- **BODY:** Aluminium (AlMg2.5)
- **MANDREL:** Steel Zinc&Clr Tri3

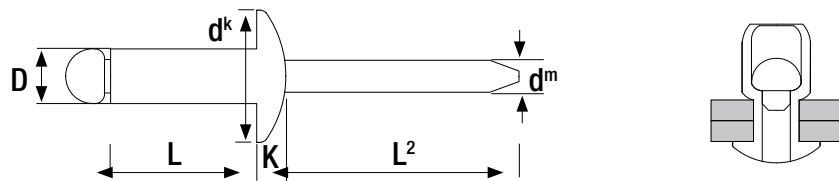

| Nominal Diameter mm (D) | Article Number | Body Length mm (L) | Grip Range Min mm | Grip Range Max mm | Hole Size mm | Flange Diameter mm (d <sup>k</sup> ) | Flange Thickness mm (K) | Nom. Mandrel Diameter mm (d <sup>m</sup> ) | Min Mandrel Length mm (L <sup>2</sup> ) | Shear Strength N | Tensile Strength N | Box Quantity | Price £ Per 1000 |
|-------------------------|----------------|--------------------|-------------------|-------------------|--------------|--------------------------------------|-------------------------|--|---|------------------|--------------------|--------------|------------------|
| 2.4                     | OJCLASD2404WH  | 4.0                | 0.5               | 2.0               | 2.5          | 5.0                                  | 0.7                     | 1.45                                       | 26.0                                    | 315              | 355                | 1000         | £14.64           |
|                         | OJCLASD2406WH  | 6.0                | 1.5               | 3.5               |              |                                      |                         |  |   |                  |                    | 1000         | £14.70           |
|                         | OJCLASD2408WH  | 8.0                | 3.5               | 5.5               |              |                                      |                         |  |   |                  |                    | 1000         | £15.09           |
|                         | OJCLASD2410WH  | 10.0               | 5.5               | 7.5               |              |                                      |                         |  |   |                  |                    | 1000         | £15.69           |
|                         | OJCLASD2412WH  | 12.0               | 7.5               | 9.5               |              |                                      |                         |  |   |                  |                    | 1000         | £17.63           |
| 3.2                     | OJCLASD3204WH  | 4.0                | 0.5               | 1.5               | 3.3          | 6.5                                  | 0.8                     | 1.75                                       | 26.0                                    | 760              | 980                | 1000         | £12.92           |
|                         | OJCLASD3206WH  | 6.0                | 1.5               | 3.0               |              |                                      |                         |  |   |                  |                    | 1000         | £14.27           |
|                         | OJCLASD3208WH  | 8.0                | 3.5               | 5.0               |              |                                      |                         |  |   |                  |                    | 1000         | £14.29           |
|                         | OJCLASD3210WH  | 10.0               | 5.0               | 7.0               |              |                                      |                         |  |   |                  |                    | 1000         | £16.13           |
|                         | OJCLASD3212WH  | 12.0               | 7.0               | 9.0               |              |                                      |                         |  |   |                  |                    | 1000         | £17.23           |
|                         | OJCLASD3214WH  | 14.0               | 9.0               | 11.0              |              |                                      |                         |  |   |                  |                    | 1000         | £17.19           |
|                         | OJCLASD3216WH  | 16.0               | 11.0              | 12.5              |              |                                      |                         |  |   |                  |                    | 500          | £19.01           |
|                         | OJCLASD3218WH  | 18.0               | 12.5              | 14.5              |              |                                      |                         |  |   |                  |                    | 500          | £20.46           |
|                         | OJCLASD3220WH  | 20.0               | 14.5              | 16.5              |              |                                      |                         |  |   |                  |                    | 500          | £21.95           |
|                         | OJCLASD3225WH  | 25.0               | 17.0              | 21.0              |              |                                      |                         |  |   |                  |                    | 500          | £26.33           |



# DOME HEAD OPEN BLIND RIVET RAL 9016 BRILLIANT WHITE

● **BODY:** Aluminium (AlMg3.5)

● **MANDREL:** Steel Zinc&Clr Tri3

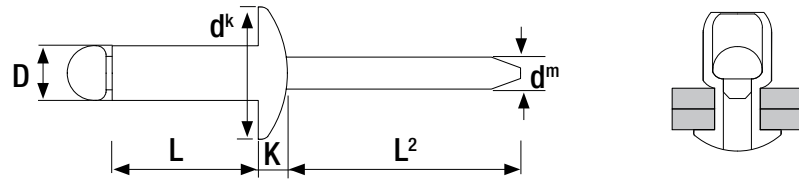

| Nominal Diameter mm (D) | Article Number | Body Length mm (L) | Grip Range Min mm | Grip Range Max mm | Hole Size mm | Flange Diameter mm (d <sup>k</sup> ) | Flange Thickness mm (K) | Nom. Mandrel Diameter mm (d <sup>m</sup> ) | Min Mandrel Length mm (L <sup>2</sup> ) | Shear Strength N | Tensile Strength N | Box Quantity | Price £ Per 1000 |
|-------------------------|----------------|--------------------|-------------------|-------------------|--------------|--------------------------------------|-------------------------|--|---|------------------|--------------------|--------------|------------------|
| 4.0                     | OJCLASD4006WH  | 6.0                | 1.5               | 3.0               | 4.1          | 8.0                                  | 1.0                     | 2.10                                       | 27.0                                    | 1200             | 1600               | 1000         | £21.01           |
|                         | OJCLASD4008WH  | 8.0                | 3.0               | 5.0               |              |                                      |                         |  |   |                  |                    | 500          | £23.22           |
|                         | OJCLASD4010WH  | 10.0               | 5.0               | 6.5               |              |                                      |                         |  |   |                  |                    | 500          | £24.34           |
|                         | OJCLASD4012WH  | 12.0               | 6.5               | 8.5               |              |                                      |                         |  |   |                  |                    | 500          | £26.66           |
|                         | OJCLASD4014WH  | 14.0               | 8.5               | 10.5              |              |                                      |                         |  |   |                  |                    | 500          | £28.99           |
|                         | OJCLASD4016WH  | 16.0               | 10.5              | 12.5              |              |                                      |                         |  |   |                  |                    | 500          | £31.56           |
|                         | OJCLASD4018WH  | 18.0               | 12.5              | 14.5              |              |                                      |                         |  |   |                  |                    | 500          | £32.87           |
|                         | OJCLASD4020WH  | 20.0               | 14.0              | 15.5              |              |                                      |                         |  |   |                  |                    | 500          | £37.09           |
|                         | OJCLASD4025WH  | 25.0               | 18.0              | 20.0              |              |                                      |                         |  |   |                  |                    | 250          | £43.36           |
|                         | OJCLASD4030WH  | 30.0               | 21.5              | 26.0              |              |                                      |                         |  |   |                  |                    | 250          | £56.27           |



Grip range and test data are guide figures only



# DOME HEAD OPEN BLIND RIVET RAL 9016 BRILLIANT WHITE

● **BODY:** Aluminium (AlMg3.5)

● **MANDREL:** Steel Zinc&Clr Tri3

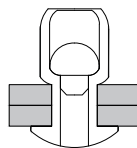
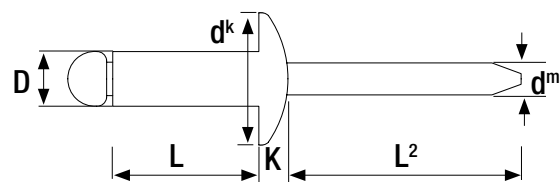

| Nominal Diameter mm (D) | Article Number | Body Length mm (L) | Grip Range Min mm | Grip Range Max mm | Hole Size mm | Flange Diameter mm (d <sup>k</sup> ) | Flange Thickness mm (K) | Nom. Mandrel Diameter mm (d <sup>m</sup> ) | Min Mandrel Length mm (L <sup>2</sup> ) | Shear Strength N | Tensile Strength N | Box Quantity | Price £ Per 1000 |
|-------------------------|----------------|--------------------|-------------------|-------------------|--------------|--------------------------------------|-------------------------|--|---|------------------|--------------------|--------------|------------------|
| 4.8                     | OJCLASD4806WH  | 6.0                | 1.0               | 2.5               | 4.9          | 9.5                                  | 1.1                     | 2.70                                       | 28.0                                    | 1700             | 2250               | 500          | £29.76           |
|                         | OJCLASD4808WH  | 8.0                | 2.5               | 4.0               |              |                                      |                         |  |   |                  |                    | 500          | £31.83           |
|                         | OJCLASD4810WH  | 10.0               | 4.0               | 6.0               |              |                                      |                         |  |   |                  |                    | 500          | £34.32           |
|                         | OJCLASD4812WH  | 12.0               | 6.0               | 8.0               |              |                                      |                         |  |   |                  |                    | 500          | £36.86           |
|                         | OJCLASD4814WH  | 14.0               | 8.0               | 10.0              |              |                                      |                         |  |   |                  |                    | 500          | £40.31           |
|                         | OJCLASD4816WH  | 16.0               | 10.0              | 12.0              |              |                                      |                         |  |   |                  |                    | 250          | £43.40           |
|                         | OJCLASD4818WH  | 18.0               | 12.0              | 14.0              |              |                                      |                         |  |   |                  |                    | 250          | £46.46           |
|                         | OJCLASD4820WH  | 20.0               | 14.0              | 16.0              |              |                                      |                         |  |   |                  |                    | 250          | £51.89           |
|                         | OJCLASD4822WH  | 22.0               | 16.0              | 18.0              |              |                                      |                         |  |   |                  |                    | 250          | £56.38           |
|                         | OJCLASD4825WH  | 25.0               | 18.0              | 21.0              |              |                                      |                         |  |   |                  |                    | 250          | £61.59           |
|                         | OJCLASD4828WH  | 28.0               | 21.0              | 23.5              |              |                                      |                         |  |   |                  |                    | 250          | £64.98           |
|                         | OJCLASD4830WH  | 30.0               | 23.0              | 25.0              |              |                                      |                         |  |   |                  |                    | 250          | £68.36           |
|                         | OJCLASD4835WH  | 35.0               | 25.0              | 30.0              |              |                                      |                         |  |   |                  |                    | 200          | £88.32           |
| OJCLASD4840WH           | 40.0           | 30.0               | 35.0              | 150               | £95.46       |                                      |                         |  |   |                  |                    |              |                  |

# DOME HEAD OPEN BLIND RIVET RAL 9005 BLACK

- **BODY:** Aluminium (AlMg2.5)
- **MANDREL:** Steel Zinc&Clr Tri3

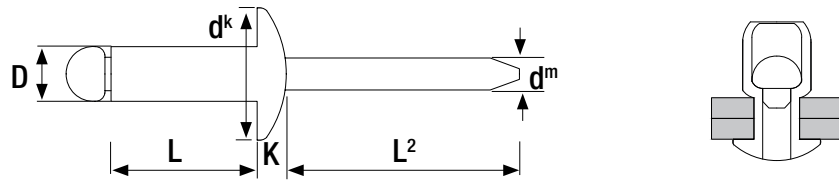

| Nominal Diameter mm (D) | Article Number | Body Length mm (L) | Grip Range Min mm | Grip Range Max mm | Hole Size mm | Flange Diameter mm (d <sup>k</sup> ) | Flange Thickness mm (K) | Nom. Mandrel Diameter mm (d <sup>m</sup> ) | Min Mandrel Length mm (L <sup>2</sup> ) | Shear Strength N | Tensile Strength N | Box Quantity | Price £ Per 1000 |
|-------------------------|----------------|--------------------|-------------------|-------------------|--------------|--------------------------------------|-------------------------|--|---|------------------|--------------------|--------------|------------------|
| 2.4                     | OJCLASD2404BL  | 4.0                | 0.5               | 2.0               | 2.5          | 5.0                                  | 0.7                     | 1.45                                       | 26.0                                    | 315              | 355                | 1000         | £14.64           |
|                         | OJCLASD2406BL  | 6.0                | 1.5               | 3.5               |              |                                      |                         |  |   |                  |                    | 1000         | £14.70           |
|                         | OJCLASD2408BL  | 8.0                | 3.5               | 5.5               |              |                                      |                         |  |   |                  |                    | 1000         | £15.09           |
|                         | OJCLASD2410BL  | 10.0               | 5.5               | 7.5               |              |                                      |                         |  |   |                  |                    | 1000         | £15.69           |
|                         | OJCLASD2412BL  | 12.0               | 7.5               | 9.5               |              |                                      |                         |  |   |                  |                    | 1000         | £17.63           |
| 3.2                     | OJCLASD3204BL  | 4.0                | 0.5               | 1.5               | 3.3          | 6.5                                  | 0.8                     | 1.75                                       | 26.0                                    | 760              | 980                | 1000         | £12.92           |
|                         | OJCLASD3206BL  | 6.0                | 1.5               | 3.0               |              |                                      |                         |  |   |                  |                    | 1000         | £13.59           |
|                         | OJCLASD3208BL  | 8.0                | 3.5               | 5.0               |              |                                      |                         |  |   |                  |                    | 1000         | £15.00           |
|                         | OJCLASD3210BL  | 10.0               | 5.0               | 7.0               |              |                                      |                         |  |   |                  |                    | 1000         | £16.13           |
|                         | OJCLASD3212BL  | 12.0               | 7.0               | 9.0               |              |                                      |                         |  |   |                  |                    | 1000         | £16.41           |
|                         | OJCLASD3214BL  | 14.0               | 9.0               | 11.0              |              |                                      |                         |  |   |                  |                    | 1000         | £17.19           |
|                         | OJCLASD3216BL  | 16.0               | 11.0              | 12.5              |              |                                      |                         |  |   |                  |                    | 500          | £19.01           |
|                         | OJCLASD3218BL  | 18.0               | 12.5              | 14.5              |              |                                      |                         |  |   |                  |                    | 500          | £20.46           |
|                         | OJCLASD3220BL  | 20.0               | 14.5              | 16.5              |              |                                      |                         |  |   |                  |                    | 500          | £21.95           |
|                         | OJCLASD3225BL  | 25.0               | 17.0              | 21.0              |              |                                      |                         |  |   |                  |                    | 500          | £26.33           |



Grip range and test data are guide figures only

# DOME HEAD OPEN BLIND RIVET RAL 9005 BLACK

● **BODY:** Aluminium (AlMg3.5)

● **MANDREL:** Steel Zinc&Clr Tri3

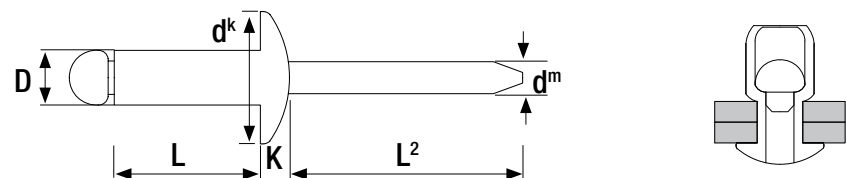

| Nominal Diameter mm (D) | Article Number | Body Length mm (L) | Grip Range Min mm | Grip Range Max mm | Hole Size mm | Flange Diameter mm (d <sup>k</sup> ) | Flange Thickness mm (K) | Nom. Mandrel Diameter mm (d <sup>m</sup> ) | Min Mandrel Length mm (L <sup>2</sup> ) | Shear Strength N | Tensile Strength N | Box Quantity | Price £ Per 1000 |
|-------------------------|----------------|--------------------|-------------------|-------------------|--------------|--------------------------------------|-------------------------|--|---|------------------|--------------------|--------------|------------------|
| 4.0                     | OJCLASD4006BL  | 6.0                | 1.5               | 3.0               | 4.1          | 8.0                                  | 1.0                     | 2.10                                       | 27.0                                    | 1200             | 1600               | 1000         | £21.01           |
|                         | OJCLASD4008BL  | 8.0                | 3.0               | 5.0               |              |                                      |                         |  |   |                  |                    | 500          | £23.22           |
|                         | OJCLASD4010BL  | 10.0               | 5.0               | 6.5               |              |                                      |                         |  |   |                  |                    | 500          | £24.34           |
|                         | OJCLASD4012BL  | 12.0               | 6.5               | 8.5               |              |                                      |                         |  |   |                  |                    | 500          | £26.66           |
|                         | OJCLASD4014BL  | 14.0               | 8.5               | 10.5              |              |                                      |                         |  |   |                  |                    | 500          | £28.99           |
|                         | OJCLASD4016BL  | 16.0               | 10.5              | 12.5              |              |                                      |                         |  |   |                  |                    | 500          | £33.14           |
|                         | OJCLASD4018BL  | 18.0               | 12.5              | 14.5              |              |                                      |                         |  |   |                  |                    | 500          | £32.87           |
|                         | OJCLASD4020BL  | 20.0               | 14.0              | 15.5              |              |                                      |                         |  |   |                  |                    | 500          | £37.09           |
|                         | OJCLASD4025BL  | 25.0               | 18.0              | 20.0              |              |                                      |                         |  |   |                  |                    | 250          | £43.36           |
| OJCLASD4030BL           | 30.0           | 21.5               | 26.0              | 250               | £56.27       |                                      |                         |  |   |                  |                    |              |                  |



# DOME HEAD OPEN BLIND RIVET RAL 9005 BLACK

● **BODY:** Aluminium (AlMg3.5)

● **MANDREL:** Steel Zinc&Clr Tri3

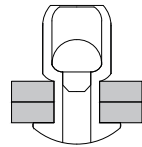
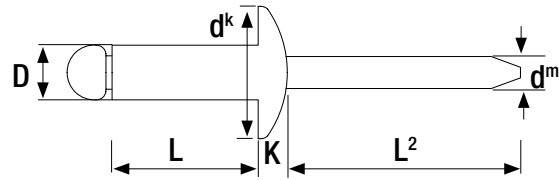

| Nominal Diameter mm (D) | Article Number | Body Length mm (L) | Grip Range Min mm | Grip Range Max mm | Hole Size mm | Flange Diameter mm (d <sup>k</sup> ) | Flange Thickness mm (K) | Nom. Mandrel Diameter mm (d <sup>m</sup> ) | Min Mandrel Length mm (L <sup>2</sup> ) | Shear Strength N | Tensile Strength N | Box Quantity | Price £ Per 1000 |
|-------------------------|----------------|--------------------|-------------------|-------------------|--------------|--------------------------------------|-------------------------|--|---|------------------|--------------------|--------------|------------------|
| 4.8                     | OJCLASD4806BL  | 6.0                | 1.0               | 2.5               | 4.9          | 9.5                                  | 1.1                     | 2.70                                       | 28.0                                    | 1700             | 2250               | 500          | £29.76           |
|                         | OJCLASD4808BL  | 8.0                | 2.5               | 4.0               |              |                                      |                         |  |   |                  |                    | 500          | £31.83           |
|                         | OJCLASD4810BL  | 10.0               | 4.0               | 6.0               |              |                                      |                         |  |   |                  |                    | 500          | £34.32           |
|                         | OJCLASD4812BL  | 12.0               | 6.0               | 8.0               |              |                                      |                         |  |   |                  |                    | 500          | £36.86           |
|                         | OJCLASD4814BL  | 14.0               | 8.0               | 10.0              |              |                                      |                         |  |   |                  |                    | 500          | £40.31           |
|                         | OJCLASD4816BL  | 16.0               | 10.0              | 12.0              |              |                                      |                         |  |   |                  |                    | 250          | £43.40           |
|                         | OJCLASD4818BL  | 18.0               | 12.0              | 14.0              |              |                                      |                         |  |   |                  |                    | 250          | £46.46           |
|                         | OJCLASD4820BL  | 20.0               | 14.0              | 16.0              |              |                                      |                         |  |   |                  |                    | 250          | £54.48           |
|                         | OJCLASD4822BL  | 22.0               | 16.0              | 18.0              |              |                                      |                         |  |   |                  |                    | 250          | £56.38           |
|                         | OJCLASD4825BL  | 25.0               | 18.0              | 21.0              |              |                                      |                         |  |   |                  |                    | 250          | £61.59           |
|                         | OJCLASD4828BL  | 28.0               | 21.0              | 23.5              |              |                                      |                         |  |   |                  |                    | 250          | £64.98           |
|                         | OJCLASD4830BL  | 30.0               | 23.0              | 25.0              |              |                                      |                         |  |   |                  |                    | 250          | £68.36           |
|                         | OJCLASD4835BL  | 35.0               | 25.0              | 30.0              |              |                                      |                         |  |   |                  |                    | 200          | £88.32           |
|                         | OJCLASD4840BL  | 40.0               | 30.0              | 35.0              |              |                                      |                         |  |   |                  |                    | 150          | £95.46           |

Grip range and test data are guide figures only

# COUNTERSUNK HEAD OPEN BLIND RIVET

- **BODY:** Aluminium (AMg2.5)
- **MANDREL:** Steel Zinc&Clr Tri3

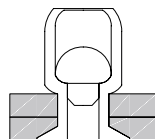
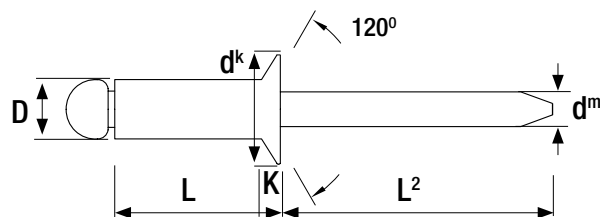

| Nominal Diameter mm (D) | Article Number | Body Length mm (L) | Grip Range Min mm | Grip Range Max mm | Hole Size mm | Flange Diameter mm (d <sup>k</sup> ) | Flange Thickness mm (K) | Nom. Mandrel Diameter mm (d <sup>m</sup> ) | Min Mandrel Length mm (L <sup>2</sup> ) | Shear Strength N | Tensile Strength N | Box Quantity | Price £ Per 1000 |
|-------------------------|----------------|--------------------|-------------------|-------------------|--------------|--------------------------------------|-------------------------|--|---|------------------|--------------------|--------------|------------------|
| <b>2.4</b>              | OJASK2406      | 6.0                | 1.5               | 3.5               | 2.5          | 5.0                                  | 0.8                     | 1.40                                       | 26.0                                    | 315              | 355                | 1000         | £14.69           |
|                         | OJASK2408      | 8.0                | 3.5               | 5.5               |              |                                      |                         |  |   |                  |                    | 1000         | £15.34           |
|                         | OJASK2410      | 10.0               | 5.5               | 7.5               |              |                                      |                         |  |   |                  |                    | 1000         | £15.83           |
| <b>3.0</b>              | OJASK3006      | 6.0                | 1.5               | 3.5               | 3.1          | 6.0                                  | 1.1                     | 1.75                                       | 26.0                                    | 620              | 810                | 1000         | £12.68           |
|                         | OJASK3008      | 8.0                | 3.5               | 5.0               |              |                                      |                         |  |   |                  |                    | 1000         | £13.41           |
|                         | OJASK3010      | 10.0               | 5.5               | 7.0               |              |                                      |                         |  |   |                  |                    | 1000         | £13.91           |
|                         | OJASK3012      | 12.0               | 7.0               | 9.0               |              |                                      |                         |  |   |                  |                    | 1000         | £15.10           |
| <b>3.2</b>              | OJASK3206      | 6.0                | 1.5               | 3.0               | 3.3          | 6.0                                  | 1.1                     | 1.95                                       | 26.0                                    | 760              | 980                | 1000         | £12.88           |
|                         | OJASK3208      | 8.0                | 3.0               | 5.0               |              |                                      |                         |  |   |                  |                    | 1000         | £13.71           |
|                         | OJASK3210      | 10.0               | 5.0               | 7.0               |              |                                      |                         |  |   |                  |                    | 1000         | £15.22           |
|                         | OJASK3212      | 12.0               | 7.0               | 9.0               |              |                                      |                         |  |   |                  |                    | 1000         | £15.54           |
|                         | OJASK3214      | 14.0               | 9.0               | 10.5              |              |                                      |                         |  |   |                  |                    | 1000         | £16.39           |
|                         | OJASK3216      | 16.0               | 10.5              | 12.5              |              |                                      |                         |  |   |                  |                    | 1000         | £18.01           |
|                         | OJASK3218      | 18.0               | 12.5              | 14.5              |              |                                      |                         |  |   |                  |                    | 700          | £19.22           |



# COUNTERSUNK HEAD OPEN BLIND RIVET

- **BODY:** Aluminium (AlMg3.5)
- **MANDREL:** Steel Zinc&Clr Tri3

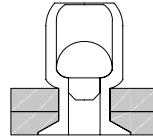
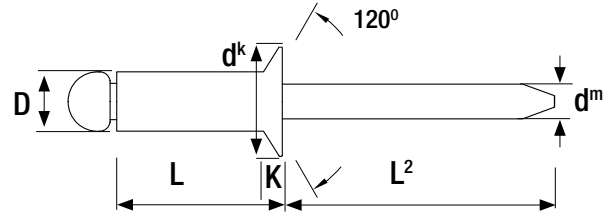

| Nominal Diameter mm (D) | Article Number | Body Length mm (L) | Grip Range Min mm | Grip Range Max mm | Hole Size mm | Flange Diameter mm (d <sup>k</sup> ) | Flange Thickness mm (K) | Nom. Mandrel Diameter mm (d <sup>m</sup> ) | Min Mandrel Length mm (L <sup>2</sup> ) | Shear Strength N | Tensile Strength N | Box Quantity | Price £ Per 1000 |
|-------------------------|----------------|--------------------|-------------------|-------------------|--------------|--------------------------------------|-------------------------|--|---|------------------|--------------------|--------------|------------------|
| 4.0                     | OJASK4006      | 6.0                | 1.0               | 2.0               | 4.1          | 7.5                                  | 1.4                     | 2.10                                       | 27.0                                    | 1200             | 1600               | 1000         | £18.20           |
|                         | OJASK4008      | 8.0                | 2.0               | 4.0               |              |                                      |                         |  |   |                  |                    | 750          | £19.45           |
|                         | OJASK4010      | 10.0               | 4.0               | 6.0               |              |                                      |                         |  |   |                  |                    | 750          | £20.20           |
|                         | OJASK4012      | 12.0               | 6.0               | 8.0               |              |                                      |                         |  |   |                  |                    | 500          | £21.21           |
|                         | OJASK4014      | 14.0               | 8.0               | 10.0              |              |                                      |                         |  |   |                  |                    | 500          | £23.50           |
|                         | OJASK4016      | 16.0               | 10.0              | 12.0              |              |                                      |                         |  |   |                  |                    | 500          | £25.33           |
|                         | OJASK4018      | 18.0               | 12.0              | 14.0              |              |                                      |                         |  |   |                  |                    | 500          | £25.85           |
|                         | OJASK4020      | 20.0               | 14.0              | 16.0              |              |                                      |                         |  |   |                  |                    | 500          | £33.92           |
| 4.8                     | OJASK4806      | 6.0                | 1.5               | 2.0               | 4.9          | 9.0                                  | 1.8                     | 2.70                                       | 28.0                                    | 1700             | 2250               | 500          | £25.85           |
|                         | OJASK4808      | 8.0                | 1.5               | 3.5               |              |                                      |                         |  |   |                  |                    | 500          | £25.27           |
|                         | OJASK4810      | 10.0               | 3.5               | 5.5               |              |                                      |                         |  |   |                  |                    | 500          | £25.98           |
|                         | OJASK4812      | 12.0               | 5.5               | 7.5               |              |                                      |                         |  |   |                  |                    | 500          | £30.39           |
|                         | OJASK4814      | 14.0               | 7.5               | 9.5               |              |                                      |                         |  |   |                  |                    | 500          | £34.27           |
|                         | OJASK4816      | 16.0               | 9.0               | 11.0              |              |                                      |                         |  |   |                  |                    | 500          | £37.16           |
|                         | OJASK4818      | 18.0               | 11.0              | 13.0              |              |                                      |                         |  |   |                  |                    | 250          | £38.56           |
|                         | OJASK4820      | 20.0               | 13.0              | 15.0              |              |                                      |                         |  |   |                  |                    | 250          | £39.09           |
|                         | OJASK4822      | 22.0               | 15.0              | 17.0              |              |                                      |                         |  |   |                  |                    | 250          | £43.98           |
|                         | OJASK4825      | 25.0               | 17.0              | 20.0              |              |                                      |                         |  |   |                  |                    | 250          | £49.11           |
|                         | OJASK4830      | 30.0               | 20.0              | 24.5              |              |                                      |                         |  |   |                  |                    | 200          | £58.83           |
|                         | OJASK4835      | 35.0               | 24.0              | 29.0              |              |                                      |                         |  |   |                  |                    | 150          | £62.77           |

Grip range and test data are guide figures only

# LARGE FLANGE HEAD OPEN BLIND RIVET

● **BODY:** Aluminium (AlMg2.5\* / AlMg3.5)

● **MANDREL:** Steel Zinc&Clr Tri3

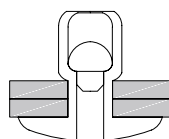
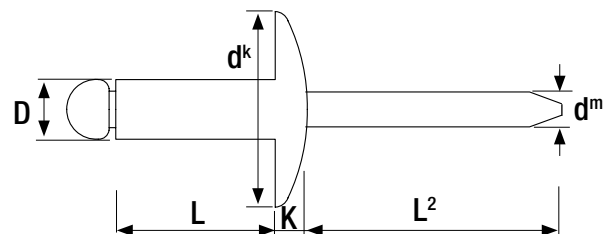

| Nominal Diameter mm (D) | Article Number | Body Length mm (L) | Grip Range Min mm | Grip Range Max mm | Hole Size mm | Flange Diameter mm (d <sup>k</sup> ) | Flange Thickness mm (K) | Nom. Mandrel Diameter mm (d <sup>m</sup> ) | Min Mandrel Length mm (L <sup>2</sup> ) | Shear Strength N | Tensile Strength N | Box Quantity | Price £ Per 1000 |
|-------------------------|----------------|--------------------|-------------------|-------------------|--------------|--------------------------------------|-------------------------|--|---|------------------|--------------------|--------------|------------------|
| 3.2                     | OJASL3206*     | 6.0                | 1.0               | 3.5               | 3.3          | 9.5                                  | 2.0                     | 1.70                                       | 26.0                                    | 740              | 980                | 500          | £22.41           |
|                         | OJASL3208*     | 8.0                | 3.5               | 5.0               |              |                                      |                         |  |   |                  |                    | 500          | £22.91           |
|                         | OJASL3210*     | 10.0               | 5.0               | 7.0               |              |                                      |                         |  |   |                  |                    | 500          | £24.17           |
|                         | OJASL3212*     | 12.0               | 7.0               | 9.0               |              |                                      |                         |  |   |                  |                    | 500          | £25.49           |
|                         | OJASL3214*     | 14.0               | 9.0               | 11.0              |              |                                      |                         |  |   |                  |                    | 500          | £27.07           |
| 4.0                     | OJASL4006      | 6.0                | 0.5               | 2.0               | 4.1          | 12.0                                 | 2.5                     | 2.10                                       | 27.0                                    | 1180             | 1600               | 500          | £35.54           |
|                         | OJASL4008      | 8.0                | 2.0               | 4.0               |              |                                      |                         |  |   |                  |                    | 500          | £36.84           |
|                         | OJASL4010      | 10.0               | 4.0               | 6.0               |              |                                      |                         |  |   |                  |                    | 500          | £37.47           |
|                         | OJASL4012      | 12.0               | 6.0               | 8.0               |              |                                      |                         |  |   |                  |                    | 500          | £40.37           |
|                         | OJASL4014      | 14.0               | 8.0               | 10.0              |              |                                      |                         |  |   |                  |                    | 500          | £41.40           |
|                         | OJASL4016      | 16.0               | 10.0              | 12.0              |              |                                      |                         |  |   |                  |                    | 500          | £43.58           |
|                         | OJASL4018      | 18.0               | 12.0              | 14.0              |              |                                      |                         |  |   |                  |                    | 400          | £44.54           |
|                         | OJASL4020      | 20.0               | 14.0              | 15.5              |              |                                      |                         |  |   |                  |                    | 300          | £48.78           |
| 4.8                     | OJASL481014    | 10.0               | 3.5               | 5.5               | 4.9          | 14.0                                 | 2.5                     | 2.70                                       | 28.0                                    | 1540             | 2230               | 250          | £54.69           |
|                         | OJASL481214    | 12.0               | 5.5               | 7.5               |              |                                      |                         |  |   |                  |                    | 250          | £58.02           |
|                         | OJASL481414    | 14.0               | 7.5               | 9.5               |              |                                      |                         |  |   |                  |                    | 250          | £62.15           |
|                         | OJASL481614    | 16.0               | 9.0               | 11.0              |              |                                      |                         |  |   |                  |                    | 250          | £62.91           |
|                         | OJASL481814    | 18.0               | 11.0              | 13.0              |              |                                      |                         |  |   |                  |                    | 250          | £67.14           |
|                         | OJASL482014    | 20.0               | 13.0              | 15.0              |              |                                      |                         |  |   |                  |                    | 200          | £70.29           |
|                         | OJASL482214    | 22.0               | 15.0              | 17.0              |              |                                      |                         |  |   |                  |                    | 200          | £74.81           |

Also available in retail bags. See page 79.





# LARGE FLANGE HEAD OPEN BLIND RIVET

- **BODY:** Aluminium (AlMg3.5)
- **MANDREL:** Steel Zinc&Clr Tri3

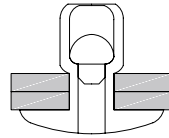
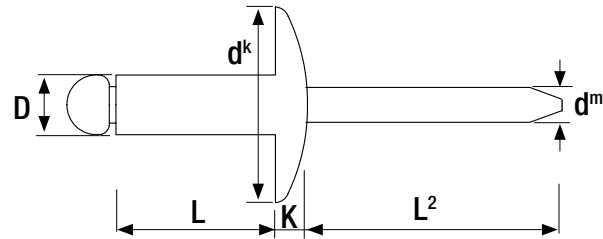

| Nominal Diameter mm (D) | Article Number | Body Length mm (L) | Grip Range Min mm | Grip Range Max mm | Hole Size mm | Flange Diameter mm (d <sup>k</sup> ) | Flange Thickness mm (K) | Nom. Mandrel Diameter mm (d <sup>m</sup> ) | Min Mandrel Length mm (L <sup>2</sup> ) | Shear Strength N | Tensile Strength N | Box Quantity | Price £ Per 1000 |
|-------------------------|----------------|--------------------|-------------------|-------------------|--------------|--------------------------------------|-------------------------|--|---|------------------|--------------------|--------------|------------------|
| 4.8                     | OJASL482414    | 24.0               | 17.0              | 19.0              | 4.9          | 14.0                                 | 2.5                     | 2.70                                       | 28.0                                    | 1540             | 2230               | 200          | £76.87           |
|                         | OJASL482614    | 26.0               | 19.5              | 21.0              |              |                                      |                         |  |   |                  |                    | 175          | £80.20           |
|                         | OJASL482814    | 28.0               | 20.0              | 23.0              |              |                                      |                         |  |   |                  |                    | 150          | £82.54           |
|                         | OJASL483014    | 30.0               | 23.0              | 24.5              |              |                                      |                         |  |   |                  |                    | 150          | £84.06           |
|                         | OJASL481016    | 10.0               | 3.5               | 5.5               |              |                                      |                         |  |   |                  |                    | 200          | £49.11           |
|                         | OJASL481216    | 12.0               | 5.5               | 7.5               |              |                                      |                         |  |   |                  |                    | 250          | £53.52           |
|                         | OJASL481416    | 14.0               | 7.5               | 9.5               | 200          | £59.06                               |                         |  |   |                  |                    |              |                  |
|                         | OJASL481616    | 16.0               | 9.0               | 11.0              | 250          | £72.26                               |                         |  |   |                  |                    |              |                  |
|                         | OJASL481816    | 18.0               | 11.0              | 13.0              | 250          | £77.10                               |                         |  |   |                  |                    |              |                  |
|                         | OJASL482016    | 20.0               | 13.0              | 15.0              | 250          | £80.78                               |                         |  |   |                  |                    |              |                  |
|                         | OJASL482216    | 22.0               | 15.0              | 17.0              | 200          | £76.27                               |                         |  |   |                  |                    |              |                  |
|                         | OJASL482416    | 24.0               | 17.0              | 19.0              | 200          | £78.43                               |                         |  |   |                  |                    |              |                  |
|                         | OJASL482616    | 26.0               | 19.5              | 21.0              | 175          | £81.76                               |                         |  |   |                  |                    |              |                  |
|                         | OJASL482816    | 28.0               | 20.0              | 23.0              | 150          | £84.24                               |                         |  |   |                  |                    |              |                  |
|                         | OJASL483016    | 30.0               | 23.0              | 24.5              | 150          | £87.49                               |                         |  |   |                  |                    |              |                  |
|                         | OJASL483516    | 35.0               | 24.5              | 29.5              | 150          | £99.54                               |                         |  |   |                  |                    |              |                  |
| OJASL484016             | 40.0           | 30.0               | 35.0              | 125               | £112.47      |                                      |                         |  |   |                  |                    |              |                  |

Grip range and test data are guide figures only

# LARGE FLANGE HEAD OPEN BLIND RIVET RAL 9005 BLACK

- **BODY:** Aluminium (AlMg2.5\* / AlMg3.5)
- **MANDREL:** Steel Zinc&Clr Tri3

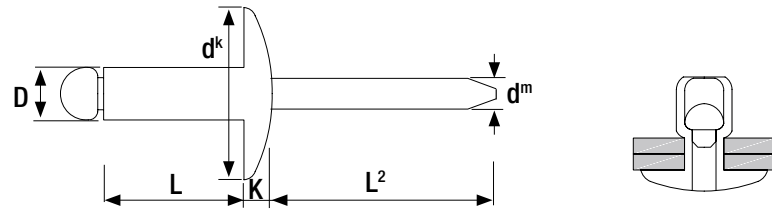

| Nominal Diameter mm (D) | Article Number  | Body Length mm (L) | Grip Range Min mm | Grip Range Max mm | Hole Size mm | Flange Diameter mm (d <sup>k</sup> ) | Flange Thickness mm (K) | Nom. Mandrel Diameter mm (d <sup>m</sup> ) | Min Mandrel Length mm (L <sup>2</sup> ) | Shear Strength N | Tensile Strength N | Box Quantity | Price £ Per 1000 |
|-------------------------|-----------------|--------------------|-------------------|-------------------|--------------|--------------------------------------|-------------------------|--|---|------------------|--------------------|--------------|------------------|
| 3.2                     | OJCLASL3208BL*  | 8.0                | 3.5               | 5.0               | 3.3          | 9.5                                  | 2.0                     | 1.70                                       | 26.0                                    | 740              | 980                | 500          | £28.43           |
|                         | OJCLASL3210BL*  | 10.0               | 5.0               | 7.0               |              |                                      |                         |  |   |                  |                    | 500          | £30.52           |
| 4.0                     | OJCLASL4008BL   | 8.0                | 2.0               | 4.0               | 4.1          | 12.0                                 | 2.5                     | 2.10                                       | 27.0                                    | 1180             | 1600               | 500          | £44.38           |
|                         | OJCLASL4010BL   | 10.0               | 4.0               | 6.0               |              |                                      |                         |  |   |                  |                    | 500          | £46.47           |
|                         | OJCLASL4012BL   | 12.0               | 6.0               | 8.0               |              |                                      |                         |  |   |                  |                    | 500          | £49.41           |
|                         | OJCLASL4014BL   | 14.0               | 8.0               | 10.0              |              |                                      |                         |  |   |                  |                    | 500          | £50.50           |
| 4.8                     | OJCLASL481016BL | 10.0               | 3.5               | 5.5               | 4.9          | 16.0                                 | 2.5                     | 2.70                                       | 28.0                                    | 1540             | 2230               | 250          | £69.73           |
|                         | OJCLASL481216BL | 12.0               | 5.5               | 7.5               |              |                                      |                         |  |   |                  |                    | 250          | £74.33           |
|                         | OJCLASL481416BL | 14.0               | 7.5               | 9.5               |              |                                      |                         |  |   |                  |                    | 200          | £77.70           |
|                         | OJCLASL481616BL | 16.0               | 9.0               | 11.0              |              |                                      |                         |  |   |                  |                    | 200          | £80.79           |
|                         | OJCLASL481816BL | 18.0               | 11.0              | 13.0              |              |                                      |                         |  |   |                  |                    | 200          | £85.77           |
|                         | OJCLASL482016BL | 20.0               | 13.0              | 15.0              |              |                                      |                         |  |   |                  |                    | 200          | £89.80           |
|                         | OJCLASL482416BL | 24.0               | 17.0              | 19.0              |              |                                      |                         |  |   |                  |                    | 200          | £99.35           |
| OJCLASL482616BL         | 26.0            | 19.5               | 21.0              | 150               | £103.24      |                                      |                         |  |   |                  |                    |              |                  |

Also available in retail bags. See page 80.

# DOME HEAD OPEN BLIND RIVET

- **BODY:** Aluminium (AlMg2.5)
- **MANDREL:** Aluminium (AlMg2.5)

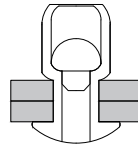
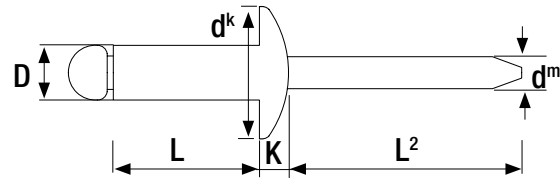

| Nominal Diameter mm (D) | Article Number | Body Length mm (L) | Grip Range Min mm | Grip Range Max mm | Hole Size mm | Flange Diameter mm (d <sup>k</sup> ) | Flange Thickness mm (K) | Nom. Mandrel Diameter mm (d <sup>m</sup> ) | Min Mandrel Length mm (L <sup>2</sup> ) | Shear Strength N | Tensile Strength N | Box Quantity | Price £ Per 1000 |
|-------------------------|----------------|--------------------|-------------------|-------------------|--------------|--------------------------------------|-------------------------|--|---|------------------|--------------------|--------------|------------------|
| 3.2                     | OJAD3206       | 6.0                | 1.5               | 3.0               | 3.3          | 6.5                                  | 0.8                     | 1.95                                       | 26.0                                    | 535              | 670                | 1000         | £21.30           |
|                         | OJAD3208       | 8.0                | 3.0               | 5.0               |              |                                      |                         |  |   |                  |                    | 1000         | £22.09           |
|                         | OJAD3210       | 10.0               | 5.0               | 7.0               |              |                                      |                         |  |   |                  |                    | 1000         | £24.54           |
|                         | OJAD3212       | 12.0               | 7.0               | 8.5               |              |                                      |                         |  |   |                  |                    | 1000         | £25.57           |
|                         | OJAD3214       | 14.0               | 8.5               | 10.5              |              |                                      |                         |  |   |                  |                    | 1000         | £28.32           |
|                         | OJAD3216       | 16.0               | 10.5              | 12.5              |              |                                      |                         |  |   |                  |                    | 800          | £29.18           |
| 4.0                     | OJAD4006       | 6.0                | 1.0               | 2.0               | 4.1          | 8.0                                  | 1.0                     | 2.45                                       | 27.0                                    | 845              | 1025               | 1000         | £32.53           |
|                         | OJAD4008       | 8.0                | 2.0               | 4.0               |              |                                      |                         |  |   |                  |                    | 800          | £33.75           |
|                         | OJAD4010       | 10.0               | 4.0               | 6.0               |              |                                      |                         |  |   |                  |                    | 800          | £36.36           |
|                         | OJAD4012       | 12.0               | 6.0               | 8.0               |              |                                      |                         |  |   |                  |                    | 800          | £38.08           |
|                         | OJAD4014       | 14.0               | 8.0               | 10.0              |              |                                      |                         |  |   |                  |                    | 500          | £38.05           |
|                         | OJAD4016       | 16.0               | 10.0              | 12.0              |              |                                      |                         |  |   |                  |                    | 500          | £40.36           |
|                         | OJAD4018       | 18.0               | 12.0              | 14.0              |              |                                      |                         |  |   |                  |                    | 500          | £43.35           |
|                         | OJAD4020       | 20.0               | 14.0              | 16.0              |              |                                      |                         |  |   |                  |                    | 250          | £46.74           |
| 4.8                     | OJAD4808       | 8.0                | 2.0               | 3.5               | 4.9          | 9.5                                  | 1.1                     | 2.90                                       | 28.0                                    | 1150             | 1420               | 500          | £46.86           |
|                         | OJAD4810       | 10.0               | 3.5               | 5.5               |              |                                      |                         |  |   |                  |                    | 500          | £49.98           |
|                         | OJAD4812       | 12.0               | 5.5               | 7.5               |              |                                      |                         |  |   |                  |                    | 500          | £51.81           |
|                         | OJAD4814       | 14.0               | 7.5               | 9.0               |              |                                      |                         |  |   |                  |                    | 500          | £56.46           |
|                         | OJAD4816       | 16.0               | 9.0               | 11.0              |              |                                      |                         |  |   |                  |                    | 400          | £57.60           |
|                         | OJAD4818       | 18.0               | 11.0              | 13.0              |              |                                      |                         |  |   |                  |                    | 400          | £63.89           |
|                         | OJAD4820       | 20.0               | 13.0              | 15.0              |              |                                      |                         |  |   |                  |                    | 350          | £66.71           |
|                         | OJAD4825       | 25.0               | 15.0              | 20.0              |              |                                      |                         |  |   |                  |                    | 250          | £77.25           |
|                         | OJAD4830       | 30.0               | 20.0              | 25.0              |              |                                      |                         |  |   |                  |                    | 200          | £91.70           |

Grip range and test data are guide figures only

# DOME HEAD OPEN BLIND RIVET

- BODY:** Steel Zinc&Clr Tri3
- MANDREL:** Steel Zinc&Clr Tri3

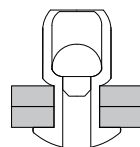
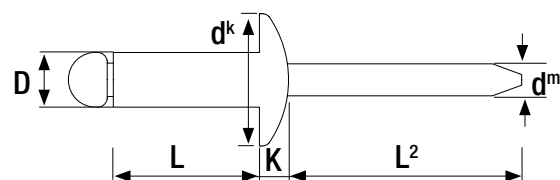

| Nominal Diameter mm (D) | Article Number | Body Length mm (L) | Grip Range Min mm | Grip Range Max mm | Hole Size mm | Flange Diameter mm (d <sup>k</sup> ) | Flange Thickness mm (K) | Nom. Mandrel Diameter mm (d <sup>m</sup> ) | Min Mandrel Length mm (L <sup>2</sup> ) | Shear Strength N | Tensile Strength N | Box Quantity | Price £ Per 1000 |
|-------------------------|----------------|--------------------|-------------------|-------------------|--------------|--------------------------------------|-------------------------|--|---|------------------|--------------------|--------------|------------------|
| 3.0                     | OJSD3006       | 6.0                | 1.5               | 3.5               | 3.1          | 6.5                                  | 0.8                     | 1.90                                       | 26.0                                    | 915              | 1125               | 1000         | £18.80           |
|                         | OJSD3008       | 8.0                | 3.5               | 5.0               |              |                                      |                         |  |   |                  |                    | 1000         | £19.13           |
|                         | OJSD3010       | 10.0               | 5.5               | 7.0               |              |                                      |                         |  |   |                  |                    | 1000         | £20.66           |
|                         | OJSD3012       | 12.0               | 7.0               | 9.0               |              |                                      |                         |  |   |                  |                    | 1000         | £22.46           |
|                         | OJSD3014       | 14.0               | 9.0               | 11.0              |              |                                      |                         |  |   |                  |                    | 1000         | £17.46           |
|                         | OJSD3016       | 16.0               | 11.0              | 12.5              |              |                                      |                         |  |   |                  |                    | 750          | £24.95           |
|                         | OJSD3018       | 18.0               | 12.0              | 14.0              |              |                                      |                         |  |   |                  |                    | 750          | £28.19           |
|                         | OJSD3020       | 20.0               | 14.5              | 16.5              |              |                                      |                         |  |   |                  |                    | 500          | £30.35           |
| 3.2                     | OJSD3206       | 6.0                | 1.5               | 3.0               | 3.3          | 6.5                                  | 0.8                     | 2.00                                       | 26.0                                    | 1060             | 1285               | 1000         | £18.92           |
|                         | OJSD3208       | 8.0                | 3.0               | 5.0               |              |                                      |                         |  |   |                  |                    | 1000         | £19.18           |
|                         | OJSD3210       | 10.0               | 5.0               | 7.0               |              |                                      |                         |  |   |                  |                    | 1000         | £20.82           |
|                         | OJSD3212       | 12.0               | 7.0               | 9.0               |              |                                      |                         |  |   |                  |                    | 750          | £22.36           |
|                         | OJSD3214       | 14.0               | 9.0               | 11.0              |              |                                      |                         |  |   |                  |                    | 1000         | £24.25           |
|                         | OJSD3216       | 16.0               | 11.0              | 12.5              |              |                                      |                         |  |   |                  |                    | 500          | £31.17           |
|                         | OJSD3218       | 18.0               | 13.0              | 14.5              |              |                                      |                         |  |   |                  |                    | 500          | £31.84           |
|                         | OJSD3220       | 20.0               | 15.0              | 16.5              |              |                                      |                         |  |   |                  |                    | 500          | £33.19           |
| 4.0                     | OJSD4006       | 6.0                | 1.0               | 2.0               | 4.1          | 8.0                                  | 1.0                     | 2.50                                       | 27.0                                    | 1550             | 1990               | 750          | £25.06           |
|                         | OJSD4008       | 8.0                | 2.0               | 4.0               |              |                                      |                         |  |   |                  |                    | 750          | £26.02           |
|                         | OJSD4010       | 10.0               | 4.0               | 6.0               |              |                                      |                         |  |   |                  |                    | 750          | £28.45           |
|                         | OJSD4012       | 12.0               | 6.0               | 8.0               |              |                                      |                         |  |   |                  |                    | 500          | £35.57           |

Also available in retail bags. See page 81.





# DOME HEAD OPEN BLIND RIVET

- BODY:** Steel Zinc&Clr Tri3
- MANDREL:** Steel Zinc&Clr Tri3

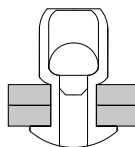
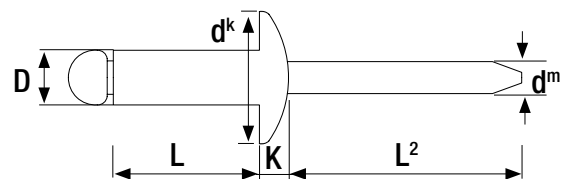

| Nominal Diameter mm (D) | Article Number | Body Length mm (L) | Grip Range Min mm | Grip Range Max mm | Hole Size mm | Flange Diameter mm (d <sup>k</sup> ) | Flange Thickness mm (K) | Nom. Mandrel Diameter mm (d <sup>m</sup> ) | Min Mandrel Length mm (L <sup>2</sup> ) | Shear Strength N | Tensile Strength N | Box Quantity | Price £ Per 1000 |
|-------------------------|----------------|--------------------|-------------------|-------------------|--------------|--------------------------------------|-------------------------|--|---|------------------|--------------------|--------------|------------------|
| 4.0                     | OJSD4014       | 14.0               | 8.0               | 10.0              | 4.1          | 8.0                                  | 1.0                     | 2.50                                       | 27.0                                    | 1550             | 1990               | 500          | £32.47           |
|                         | OJSD4016       | 16.0               | 10.0              | 12.0              |              |                                      |                         |  |   |                  |                    | 500          | £38.66           |
|                         | OJSD4018       | 18.0               | 12.0              | 14.0              |              |                                      |                         |  |   |                  |                    | 500          | £39.75           |
|                         | OJSD4020       | 20.0               | 14.0              | 15.5              |              |                                      |                         |  |   |                  |                    | 500          | £41.43           |
|                         | OJSD4024       | 24.0               | 18.0              | 19.5              |              |                                      |                         |  |   |                  |                    | 250          | £46.20           |
| 4.8                     | OJSD4806       | 6.0                | 1.0               | 2.0               | 4.9          | 9.5                                  | 1.1                     | 2.90                                       | 28.0                                    | 2300             | 2920               | 500          | £34.69           |
|                         | OJSD4808       | 8.0                | 2.0               | 3.5               |              |                                      |                         |  |   |                  |                    | 500          | £36.13           |
|                         | OJSD4810       | 10.0               | 3.5               | 5.5               |              |                                      |                         |  |   |                  |                    | 500          | £37.50           |
|                         | OJSD4812       | 12.0               | 5.5               | 7.5               |              |                                      |                         |  |   |                  |                    | 500          | £40.26           |
|                         | OJSD4814       | 14.0               | 7.5               | 9.5               |              |                                      |                         |  |   |                  |                    | 500          | £44.91           |
|                         | OJSD4816       | 16.0               | 9.0               | 11.0              |              |                                      |                         |  |   |                  |                    | 400          | £48.02           |
|                         | OJSD4818       | 18.0               | 11.0              | 13.0              |              |                                      |                         |  |   |                  |                    | 400          | £50.18           |
|                         | OJSD4820       | 20.0               | 13.0              | 15.0              |              |                                      |                         |  |   |                  |                    | 350          | £55.36           |
|                         | OJSD4822       | 22.0               | 15.0              | 17.0              |              |                                      |                         |  |   |                  |                    | 300          | £63.52           |
|                         | OJSD4825       | 25.0               | 17.0              | 20.0              |              |                                      |                         |  |   |                  |                    | 250          | £68.45           |
|                         | OJSD4830       | 30.0               | 20.0              | 24.5              |              |                                      |                         |  |   |                  |                    | 250          | £80.68           |
| 5.0                     | OJSD5008       | 8.0                | 2.0               | 3.5               | 5.1          | 9.5                                  | 1.1                     | 2.90                                       | 28.0                                    | 2575             | 3255               | 500          | £38.17           |
|                         | OJSD5010       | 10.0               | 3.5               | 5.5               |              |                                      |                         |  |   |                  |                    | 500          | £41.22           |
|                         | OJSD5012       | 12.0               | 5.5               | 7.5               |              |                                      |                         |  |   |                  |                    | 500          | £42.84           |
|                         | OJSD5014       | 14.0               | 7.5               | 9.5               |              |                                      |                         |  |   |                  |                    | 500          | £46.10           |
|                         | OJSD5016       | 16.0               | 9.0               | 11.0              |              |                                      |                         |  |   |                  |                    | 400          | £49.47           |
|                         | OJSD5018       | 18.0               | 11.0              | 13.0              |              |                                      |                         |  |   |                  |                    | 400          | £51.88           |
|                         | OJSD5020       | 20.0               | 13.5              | 15.0              |              |                                      |                         |  |   |                  |                    | 350          | £58.45           |

Grip range and test data are guide figures only

# DOME HEAD OPEN BLIND RIVET

- **BODY:** Steel Zinc&Clr Tri3
- **MANDREL:** Steel Zinc&Clr Tri3

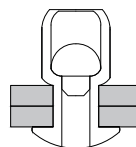
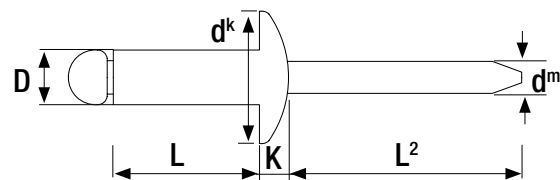

| Nominal Diameter mm (D) | Article Number | Body Length mm (L) | Grip Range Min mm | Grip Range Max mm | Hole Size mm | Flange Diameter mm (d <sup>k</sup> ) | Flange Thickness mm (K) | Nom. Mandrel Diameter mm (d <sup>m</sup> ) | Min Mandrel Length mm (L <sup>2</sup> ) | Shear Strength N | Tensile Strength N | Box Quantity | Price £ Per 1000 |
|-------------------------|----------------|--------------------|-------------------|-------------------|--------------|--------------------------------------|-------------------------|--|---|------------------|--------------------|--------------|------------------|
| 6.0                     | OJSD6010       | 10.0               | 2.5               | 4.0               | 6.1          | 12.0                                 | 1.5                     | 3.65                                       | 30.0                                    | 4000             | 5000               | 250          | £68.71           |
|                         | OJSD6012       | 12.0               | 4.5               | 6.0               |              |                                      |                         |  |   |                  |                    | 250          | £69.73           |
|                         | OJSD6015       | 15.0               | 6.0               | 9.0               |              |                                      |                         |  |   |                  |                    | 200          | £72.59           |
|                         | OJSD6016       | 16.0               | 8.5               | 10.5              |              |                                      |                         |  |   |                  |                    | 200          | £74.22           |
|                         | OJSD6018       | 18.0               | 10.5              | 12.0              |              |                                      |                         |  |   |                  |                    | 200          | £82.92           |
|                         | OJSD6022       | 22.0               | 12.5              | 16.5              |              |                                      |                         |  |   |                  |                    | 200          | £111.14          |
|                         | OJSD6026       | 26.0               | 16.0              | 19.0              |              |                                      |                         |  |   |                  |                    | 200          | £122.71          |
| 6.4                     | OJSD6410       | 10.0               | 1.5               | 3.5               | 6.5          | 13.0                                 | 1.8                     | 3.85                                       | 32.0                                    | 4350             | 5400               | 250          | £71.99           |
|                         | OJSD6412       | 12.0               | 3.5               | 5.5               |              |                                      |                         |  |   |                  |                    | 250          | £79.38           |
|                         | OJSD6415       | 15.0               | 5.5               | 8.5               |              |                                      |                         |  |   |                  |                    | 250          | £84.17           |
|                         | OJSD6418       | 18.0               | 8.5               | 11.5              |              |                                      |                         |  |   |                  |                    | 250          | £88.85           |
|                         | OJSD6420       | 20.0               | 10.5              | 13.5              |              |                                      |                         |  |   |                  |                    | 150          | £107.17          |
|                         | OJSD6422       | 22.0               | 11.5              | 15.5              |              |                                      |                         |  |   |                  |                    | 150          | £116.24          |
|                         | OJSD6426       | 26.0               | 15.5              | 19.0              |              |                                      |                         |  |   |                  |                    | 150          | £131.15          |
|                         | OJSD6430       | 30.0               | 19.0              | 23.0              |              |                                      |                         |  |   |                  |                    | 125          | £150.71          |

# COUNTERSUNK HEAD OPEN BLIND RIVET

- BODY:** Steel Zinc&Clr Tri3
- MANDREL:** Steel Zinc&Clr Tri3

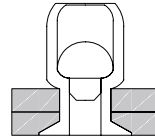
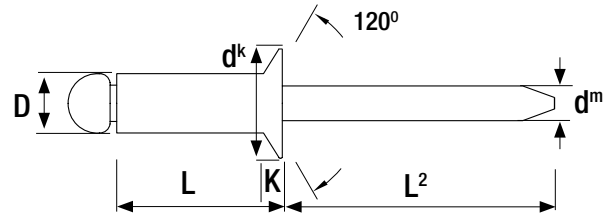

| Nominal Diameter mm (D) | Article Number | Body Length mm (L) | Grip Range Min mm | Grip Range Max mm | Hole Size mm | Flange Diameter mm (d <sup>k</sup> ) | Flange Thickness mm (K) | Nom. Mandrel Diameter mm (d <sup>m</sup> ) | Min Mandrel Length mm (L <sup>2</sup> ) | Shear Strength N | Tensile Strength N | Box Quantity | Price £ Per 1000 |
|-------------------------|----------------|--------------------|-------------------|-------------------|--------------|--------------------------------------|-------------------------|--|---|------------------|--------------------|--------------|------------------|
| 3.0                     | OJSK3006       | 6.0                | 1.5               | 3.0               | 3.1          | 6.0                                  | 1.1                     | 1.90                                       | 26.0                                    | 950              | 1125               | 1000         | £20.07           |
|                         | OJSK3008       | 8.0                | 3.0               | 5.0               |              |                                      |                         |  |   |                  |                    | 1000         | £20.39           |
|                         | OJSK3010       | 10.0               | 5.0               | 6.5               |              |                                      |                         |  |   |                  |                    | 1000         | £22.08           |
|                         | OJSK3012       | 12.0               | 6.5               | 8.0               |              |                                      |                         |  |   |                  |                    | 1000         | £22.94           |
| 3.2                     | OJSK3205       | 5.5                | 1.0               | 2.5               | 3.3          | 6.0                                  | 1.1                     | 2.00                                       | 26.0                                    | 1060             | 1285               | 1000         | £20.33           |
|                         | OJSK3206       | 6.0                | 1.5               | 3.0               |              |                                      |                         |  |   |                  |                    | 1000         | £22.01           |
|                         | OJSK3208       | 8.0                | 3.0               | 5.0               |              |                                      |                         |  |   |                  |                    | 1000         | £21.38           |
|                         | OJSK3210       | 10.0               | 5.0               | 6.5               |              |                                      |                         |  |   |                  |                    | 1000         | £22.68           |
|                         | OJSK3212       | 12.0               | 6.5               | 8.0               |              |                                      |                         |  |   |                  |                    | 1000         | £23.93           |
|                         | OJSK3214       | 14.0               | 8.0               | 10.0              |              |                                      |                         |  |   |                  |                    | 1000         | £24.69           |
| 4.0                     | OJSK4006       | 6.0                | 1.5               | 2.0               | 4.1          | 7.5                                  | 1.4                     | 2.50                                       | 27.0                                    | 1550             | 1990               | 1000         | £29.43           |
|                         | OJSK4008       | 8.0                | 2.0               | 4.0               |              |                                      |                         |  |   |                  |                    | 800          | £28.87           |
|                         | OJSK4010       | 10.0               | 4.0               | 6.0               |              |                                      |                         |  |   |                  |                    | 800          | £30.93           |
|                         | OJSK4012       | 12.0               | 6.0               | 8.0               |              |                                      |                         |  |   |                  |                    | 800          | £34.90           |
|                         | OJSK4014       | 14.0               | 8.0               | 10.0              |              |                                      |                         |  |   |                  |                    | 500          | £35.84           |
|                         | OJSK4016       | 16.0               | 10.0              | 12.0              |              |                                      |                         |  |   |                  |                    | 500          | £39.42           |
|                         | OJSK4018       | 18.0               | 12.0              | 14.0              |              |                                      |                         |  |   |                  |                    | 500          | £40.51           |
|                         | OJSK4020       | 20.0               | 14.0              | 15.5              |              |                                      |                         |  |   |                  |                    | 500          | £42.24           |
| 4.8                     | OJSK4808       | 8.0                | 1.5               | 3.5               | 4.9          | 9.0                                  | 1.8                     | 2.90                                       | 28.0                                    | 2300             | 2920               | 500          | £38.22           |
|                         | OJSK4810       | 10.0               | 3.5               | 5.5               |              |                                      |                         |  |   |                  |                    | 500          | £41.22           |
|                         | OJSK4812       | 12.0               | 5.5               | 7.5               |              |                                      |                         |  |   |                  |                    | 500          | £44.32           |
|                         | OJSK4814       | 14.0               | 7.5               | 9.5               |              |                                      |                         |  |   |                  |                    | 500          | £49.55           |
|                         | OJSK4816       | 16.0               | 9.0               | 11.0              |              |                                      |                         |  |   |                  |                    | 400          | £48.99           |
|                         | OJSK4818       | 18.0               | 11.0              | 13.0              |              |                                      |                         |  |   |                  |                    | 400          | £51.16           |
|                         | OJSK4820       | 20.0               | 13.0              | 15.0              |              |                                      |                         |  |   |                  |                    | 350          | £56.43           |
|                         | OJSK4825       | 25.0               | 17.0              | 20.0              |              |                                      |                         |  |   |                  |                    | 250          | £69.86           |

# LARGE FLANGE HEAD OPEN BLIND RIVET

- BODY:** Steel Zinc&Clr Tri3
- MANDREL:** Steel Zinc&Clr Tri3

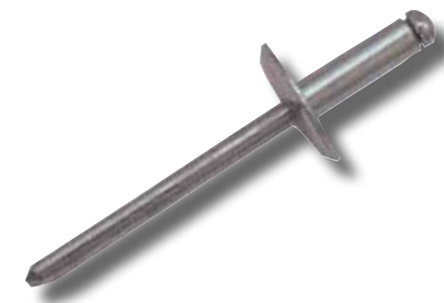
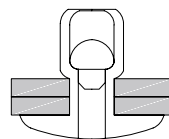
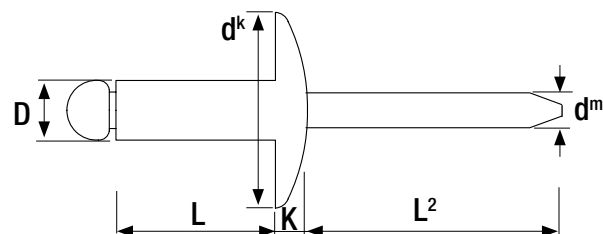

| Nominal Diameter mm (D) | Article Number | Body Length mm (L) | Grip Range Min mm | Grip Range Max mm | Hole Size mm | Flange Diameter mm (d <sup>k</sup> ) | Flange Thickness mm (K) | Nom. Mandrel Diameter mm (d <sup>m</sup> ) | Min Mandrel Length mm (L <sup>2</sup> ) | Shear Strength N | Tensile Strength N | Box Quantity | Price £ Per 1000 |
|-------------------------|----------------|--------------------|-------------------|-------------------|--------------|--------------------------------------|-------------------------|--|---|------------------|--------------------|--------------|------------------|
| 4.8                     | OJSL481016     | 10.0               | 4.5               | 6.0               | 4.9          | 16.0                                 | 2.5                     | 2.90                                       | 28.0                                    | 2300             | 2920               | 250          | £57.74           |
|                         | OJSL481216     | 12.0               | 6.0               | 8.0               |              |                                      |                         |  |   |                  |                    | 250          | £62.41           |
|                         | OJSL481416     | 14.0               | 8.0               | 10.0              |              |                                      |                         |  |   |                  |                    | 250          | £70.04           |
|                         | OJSL481616     | 16.0               | 10.0              | 11.5              |              |                                      |                         |  |   |                  |                    | 250          | £68.68           |
|                         | OJSL481816     | 18.0               | 11.5              | 13.5              |              |                                      |                         |  |   |                  |                    | 250          | £71.56           |
|                         | OJSL482016     | 20.0               | 13.5              | 15.0              |              |                                      |                         |  |   |                  |                    | 200          | £83.10           |
|                         | OJSL482516     | 25.0               | 17.0              | 20.0              |              |                                      |                         |  |   |                  |                    | 200          | £93.85           |



# DOME HEAD OPEN BLIND RIVET

**BODY:** Copper 110

**MANDREL:** Steel Zinc&Clr Tri3

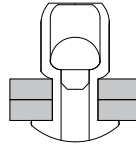
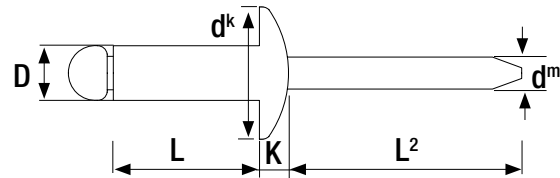

| Nominal Diameter mm (D) | Article Number | Body Length mm (L) | Grip Range Min mm | Grip Range Max mm | Hole Size mm | Flange Diameter mm (d <sup>k</sup> ) | Flange Thickness mm (K) | Nom. Mandrel Diameter mm (d <sup>m</sup> ) | Min Mandrel Length mm (L <sup>2</sup> ) | Shear Strength N | Tensile Strength N | Box Quantity | Price £ Per 1000 |
|-------------------------|----------------|--------------------|-------------------|-------------------|--------------|--------------------------------------|-------------------------|--|---|------------------|--------------------|--------------|------------------|
| 3.2                     | OJCSD3206      | 6.0                | 1.0               | 3.0               | 3.3          | 6.5                                  | 0.8                     | 1.95                                       | 26.0                                    | 700              | 800                | 1000         | £55.48           |
|                         | OJCSD3208      | 8.0                | 3.0               | 5.0               |              |                                      |                         |  |   |                  |                    | 1000         | £62.39           |
|                         | OJCSD3210      | 10.0               | 5.0               | 7.0               |              |                                      |                         |  |   |                  |                    | 1000         | £80.52           |
|                         | OJCSD3212      | 12.0               | 7.0               | 9.0               |              |                                      |                         |  |   |                  |                    | 1000         | £82.19           |
| 4.0                     | OJCSD4006      | 6.0                | 1.0               | 2.0               | 4.1          | 8.0                                  | 1.0                     | 2.10                                       | 27.0                                    | 1000             | 1500               | 1000         | £98.28           |
|                         | OJCSD4008      | 8.0                | 2.5               | 4.5               |              |                                      |                         |  |   |                  |                    | 800          | £106.66          |
|                         | OJCSD4010      | 10.0               | 4.0               | 6.0               |              |                                      |                         |  |   |                  |                    | 800          | £119.80          |
|                         | OJCSD4012      | 12.0               | 6.0               | 8.0               |              |                                      |                         |  |   |                  |                    | 800          | £138.15          |
|                         | OJCSD4014      | 14.0               | 8.0               | 10.0              |              |                                      |                         |  |   |                  |                    | 500          | £157.00          |
|                         | OJCSD4016      | 16.0               | 10.0              | 12.0              |              |                                      |                         |  |   |                  |                    | 500          | £170.56          |

*Grip range and test data are guide figures only*

# DOME HEAD OPEN BLIND RIVET

- BODY:** A2 Stainless Steel (AISI304)
- MANDREL:** A2 Stainless Steel (AISI304) (Grooved)

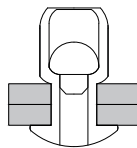
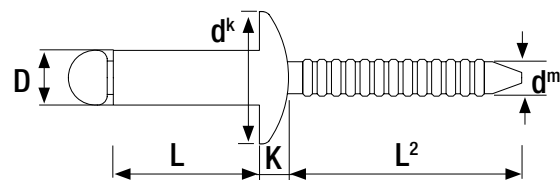

| Nominal Diameter mm (D) | Article Number | Body Length mm (L) | Grip Range Min mm | Grip Range Max mm | Hole Size mm | Flange Diameter mm (d <sup>k</sup> ) | Flange Thickness mm (K) | Nom. Mandrel Diameter mm (d <sup>m</sup> ) | Min Mandrel Length mm (L <sup>2</sup> ) | Shear Strength N | Tensile Strength N | Box Quantity | Price £ Per 1000 |
|-------------------------|----------------|--------------------|-------------------|-------------------|--------------|--------------------------------------|-------------------------|--|---|------------------|--------------------|--------------|------------------|
| 3.2                     | OJSSD3206      | 6.0                | 1.0               | 3.0               | 3.3          | 6.5                                  | 0.8                     | 2.00                                       | 26.0                                    | 1800             | 2500               | 1000         | £49.72           |
|                         | OJSSD3208      | 8.0                | 3.0               | 5.0               |              |                                      |                         |  |   |                  |                    | 1000         | £50.88           |
|                         | OJSSD3210      | 10.0               | 5.0               | 7.0               |              |                                      |                         |  |   |                  |                    | 1000         | £53.02           |
|                         | OJSSD3212      | 12.0               | 7.0               | 9.0               |              |                                      |                         |  |   |                  |                    | 1000         | £55.71           |
|                         | OJSSD3214      | 14.0               | 9.0               | 11.0              |              |                                      |                         |  |   |                  |                    | 1000         | £62.11           |
|                         | OJSSD3216      | 16.0               | 9.0               | 12.0              |              |                                      |                         |  |   |                  |                    | 800          | £76.58           |
|                         | OJSSD3218      | 18.0               | 12.0              | 14.5              |              |                                      |                         |  |   |                  |                    | 500          | £71.31           |
| 4.0                     | OJSSD4006      | 6.0                | 1.0               | 2.0               | 4.1          | 8.0                                  | 1.0                     | 2.50                                       | 27.0                                    | 3100             | 3800               | 1000         | £70.66           |
|                         | OJSSD4008      | 8.0                | 2.0               | 4.0               |              |                                      |                         |  |   |                  |                    | 800          | £71.15           |
|                         | OJSSD4010      | 10.0               | 4.0               | 6.0               |              |                                      |                         |  |   |                  |                    | 800          | £75.93           |
|                         | OJSSD4012      | 12.0               | 6.0               | 8.0               |              |                                      |                         |  |   |                  |                    | 800          | £78.85           |
|                         | OJSSD4014      | 14.0               | 8.0               | 10.0              |              |                                      |                         |  |   |                  |                    | 500          | £85.35           |
|                         | OJSSD4016      | 16.0               | 9.5               | 12.0              |              |                                      |                         |  |   |                  |                    | 500          | £92.11           |
|                         | OJSSD4018      | 18.0               | 12.0              | 14.0              |              |                                      |                         |  |   |                  |                    | 500          | £106.75          |
|                         | OJSSD4020      | 20.0               | 14.0              | 15.5              |              |                                      |                         |  |   |                  |                    | 500          | £109.88          |
|                         | OJSSD4025      | 25.0               | 16.0              | 20.0              |              |                                      |                         |  |   |                  |                    | 250          | £131.17          |



# DOME HEAD OPEN BLIND RIVET

- BODY:** A2 Stainless Steel (AISI304)
- MANDREL:** A2 Stainless Steel (AISI304) (Grooved)

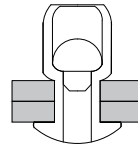
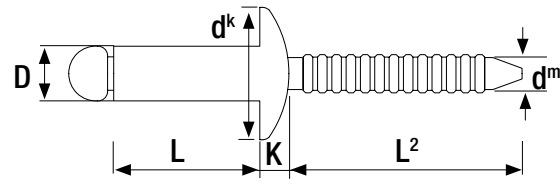

| Nominal Diameter mm (D) | Article Number | Body Length mm (L) | Grip Range Min mm | Grip Range Max mm | Hole Size mm | Flange Diameter mm (d <sup>k</sup> ) | Flange Thickness mm (K) | Nom. Mandrel Diameter mm (d <sup>m</sup> ) | Min Mandrel Length mm (L <sup>2</sup> ) | Shear Strength N | Tensile Strength N | Box Quantity | Price £ Per 1000 |
|-------------------------|----------------|--------------------|-------------------|-------------------|--------------|--------------------------------------|-------------------------|--|---|------------------|--------------------|--------------|------------------|
| 4.8                     | OJSSD4808      | 8.0                | 1.5               | 4.0               | 4.9          | 9.5                                  | 1.1                     | 2.90                                       | 28.0                                    | 4500             | 6000               | 500          | £98.21           |
|                         | OJSSD4810      | 10.0               | 4.0               | 6.0               |              |                                      |                         |  |   |                  |                    | 500          | £107.74          |
|                         | OJSSD4812      | 12.0               | 6.0               | 8.0               |              |                                      |                         |  |   |                  |                    | 500          | £110.98          |
|                         | OJSSD4814      | 14.0               | 8.0               | 9.5               |              |                                      |                         |  |   |                  |                    | 500          | £115.38          |
|                         | OJSSD4816      | 16.0               | 9.5               | 11.0              |              |                                      |                         |  |   |                  |                    | 400          | £127.05          |
|                         | OJSSD4818      | 18.0               | 11.0              | 13.0              |              |                                      |                         |  |   |                  |                    | 400          | £133.76          |
|                         | OJSSD4820      | 20.0               | 13.0              | 15.0              |              |                                      |                         |  |   |                  |                    | 350          | £145.18          |
|                         | OJSSD4822      | 22.0               | 15.0              | 17.0              |              |                                      |                         |  |   |                  |                    | 300          | £160.88          |
|                         | OJSSD4825      | 25.0               | 17.0              | 20.0              |              |                                      |                         |  |   |                  |                    | 250          | £179.76          |
|                         | OJSSD4827      | 27.0               | 18.0              | 22.0              |              |                                      |                         |  |   |                  |                    | 250          | £211.28          |
| OJSSD4830               | 30.0           | 21.0               | 25.0              | 250               | £229.09      |                                      |                         |  |   |                  |                    |              |                  |
| 6.0                     | OJSSD6010      | 10.0               | 1.5               | 4.0               | 6.1          | 12.0                                 | 1.5                     | 3.60                                       | 30.0                                    | 6500             | 8850               | 250          | £210.69          |
|                         | OJSSD6012      | 12.0               | 4.0               | 6.0               |              |                                      |                         |  |   |                  |                    | 200          | £223.91          |
|                         | OJSSD6015      | 15.0               | 6.0               | 9.0               |              |                                      |                         |  |   |                  |                    | 200          | £231.87          |
|                         | OJSSD6018      | 18.0               | 9.0               | 12.0              |              |                                      |                         |  |   |                  |                    | 200          | £274.43          |
|                         | OJSSD6020      | 20.0               | 11.0              | 14.0              |              |                                      |                         |  |   |                  |                    | 200          | £283.23          |
|                         | OJSSD6022      | 22.0               | 12.0              | 16.0              |              |                                      |                         |  |   |                  |                    | 200          | £292.58          |
|                         | OJSSD6025      | 25.0               | 16.0              | 19.0              |              |                                      |                         |  |   |                  |                    | 100          | £315.27          |
|                         | OJSSD6410      | 10.0               | 1.5               | 3.5               |              |                                      |                         |  |   |                  |                    | 6.5          | 13.0             |
| OJSSD6412               | 12.0           | 3.5                | 5.5               | 250               | £283.70      |                                      |                         |  |   |                  |                    |              |                  |
| OJSSD6415               | 15.0           | 5.5                | 8.5               | 200               | £320.14      |                                      |                         |  |   |                  |                    |              |                  |
| OJSSD6418               | 18.0           | 8.5                | 11.5              | 200               | £324.25      |                                      |                         |  |   |                  |                    |              |                  |
| OJSSD6420               | 20.0           | 11.5               | 13.5              | 150               | £343.38      |                                      |                         |  |   |                  |                    |              |                  |
| OJSSD6425               | 25.0           | 13.5               | 18.0              | 150               | £491.62      |                                      |                         |  |   |                  |                    |              |                  |

Grip range and test data are guide figures only

# COUNTERSUNK HEAD OPEN BLIND RIVET

- BODY:** A2 Stainless Steel (AISI304)
- MANDREL:** A2 Stainless Steel (AISI304) (Grooved)

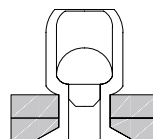
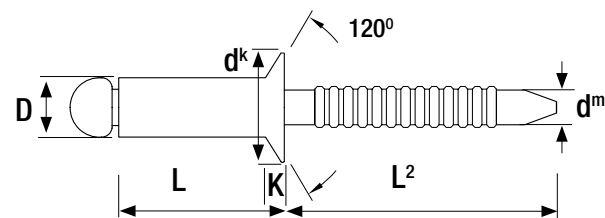

| Nominal Diameter mm (D) | Article Number | Body Length mm (L) | Grip Range Min mm | Grip Range Max mm | Hole Size mm | Flange Diameter mm (d <sup>k</sup> ) | Flange Thickness mm (K) | Nom. Mandrel Diameter mm (d <sup>m</sup> ) | Min Mandrel Length mm (L <sup>2</sup> ) | Shear Strength N | Tensile Strength N | Box Quantity | Price £ Per 1000 |
|-------------------------|----------------|--------------------|-------------------|-------------------|--------------|--------------------------------------|-------------------------|--|---|------------------|--------------------|--------------|------------------|
| 3.2                     | OJSSK3206      | 6.0                | 1.5               | 3.0               | 3.3          | 6.0                                  | 1.1                     | 1.90                                       | 26.0                                    | 1800             | 2500               | 1000         | £46.18           |
|                         | OJSSK3208      | 8.0                | 3.0               | 5.0               |              |                                      |                         |  |   |                  |                    | 1000         | £50.00           |
|                         | OJSSK3210      | 10.0               | 5.0               | 6.5               |              |                                      |                         |  |   |                  |                    | 1000         | £55.48           |
|                         | OJSSK3212      | 12.0               | 6.5               | 8.5               |              |                                      |                         |  |   |                  |                    | 1000         | £62.13           |
|                         | OJSSK3214      | 14.0               | 8.5               | 10.5              |              |                                      |                         |  |   |                  |                    | 1000         | £66.66           |
| 4.0                     | OJSSK4006      | 6.0                | 1.5               | 2.0               | 4.1          | 7.5                                  | 1.2                     | 2.50                                       | 27.0                                    | 3100             | 3800               | 750          | £78.33           |
|                         | OJSSK4008      | 8.0                | 2.0               | 4.0               |              |                                      |                         |  |   |                  |                    | 750          | £72.73           |
|                         | OJSSK4010      | 10.0               | 4.0               | 6.0               |              |                                      |                         |  |   |                  |                    | 750          | £73.20           |
|                         | OJSSK4012      | 12.0               | 6.0               | 8.0               |              |                                      |                         |  |   |                  |                    | 750          | £93.08           |
|                         | OJSSK4014      | 14.0               | 8.0               | 10.0              |              |                                      |                         |  |   |                  |                    | 500          | £91.18           |
|                         | OJSSK4016      | 16.0               | 10.0              | 12.0              |              |                                      |                         |  |   |                  |                    | 500          | £101.41          |
|                         | OJSSK4018      | 18.0               | 12.0              | 14.0              |              |                                      |                         |  |   |                  |                    | 500          | £105.22          |
|                         | OJSSK4020      | 20.0               | 14.0              | 16.0              |              |                                      |                         |  |   |                  |                    | 500          | £109.62          |
| 4.8                     | OJSSK4808      | 8.0                | 1.5               | 3.5               | 4.9          | 9.0                                  | 1.5                     | 3.00                                       | 28.0                                    | 4500             | 6000               | 500          | £93.63           |
|                         | OJSSK4810      | 10.0               | 3.5               | 5.5               |              |                                      |                         |  |   |                  |                    | 500          | £101.48          |
|                         | OJSSK4812      | 12.0               | 5.5               | 7.5               |              |                                      |                         |  |   |                  |                    | 500          | £108.62          |
|                         | OJSSK4814      | 14.0               | 7.5               | 9.5               |              |                                      |                         |  |   |                  |                    | 500          | £114.98          |
|                         | OJSSK4816      | 16.0               | 9.0               | 11.0              |              |                                      |                         |  |   |                  |                    | 500          | £121.13          |
|                         | OJSSK4818      | 18.0               | 11.0              | 13.0              |              |                                      |                         |  |   |                  |                    | 500          | £136.77          |
|                         | OJSSK4820      | 20.0               | 13.0              | 15.0              |              |                                      |                         |  |   |                  |                    | 250          | £145.93          |
|                         | OJSSK4825      | 25.0               | 15.0              | 19.0              |              |                                      |                         |  |   |                  |                    | 250          | £175.64          |



# LARGE FLANGE HEAD OPEN BLIND RIVET

- BODY:** A2 Stainless Steel (AISI304)
- MANDREL:** A2 Stainless Steel (AISI304) (Grooved)

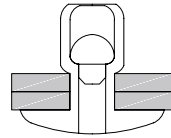
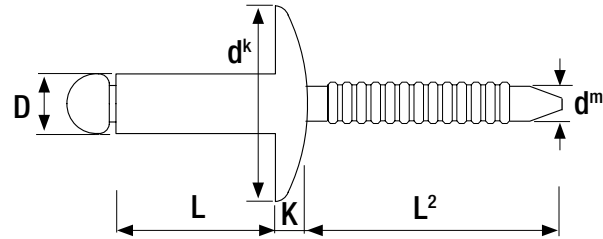

| Nominal Diameter mm (D) | Article Number | Body Length mm (L) | Grip Range Min mm | Grip Range Max mm | Hole Size mm | Flange Diameter mm (d <sup>k</sup> ) | Flange Thickness mm (K) | Nom. Mandrel Diameter mm (d <sup>m</sup> ) | Min Mandrel Length mm (L <sup>2</sup> ) | Shear Strength N | Tensile Strength N | Box Quantity | Price £ Per 1000 |
|-------------------------|----------------|--------------------|-------------------|-------------------|--------------|--------------------------------------|-------------------------|--|---|------------------|--------------------|--------------|------------------|
| 3.2                     | OJSSL3206      | 6.0                | 1.0               | 3.5               | 3.3          | 9.5                                  | 1.3                     | 1.90                                       | 26.0                                    | 1875             | 2360               | 1000         | £69.32           |
|                         | OJSSL3208      | 8.0                | 3.5               | 5.0               |              |                                      |                         |  |   |                  |                    | 1000         | £72.80           |
|                         | OJSSL3210      | 10.0               | 5.0               | 7.0               |              |                                      |                         |  |   |                  |                    | 500          | £77.59           |
|                         | OJSSL3212      | 12.0               | 7.0               | 9.0               |              |                                      |                         |  |   |                  |                    | 500          | £81.32           |
|                         | OJSSL3214      | 14.0               | 9.0               | 11.0              |              |                                      |                         |  |   |                  |                    | 500          | £86.64           |
| 4.0                     | OJSSL4006      | 6.0                | 1.0               | 2.0               | 4.1          | 12.0                                 | 1.6                     | 2.50                                       | 27.0                                    | 2895             | 3650               | 500          | £100.06          |
|                         | OJSSL4008      | 8.0                | 2.0               | 4.0               |              |                                      |                         |  |   |                  |                    | 500          | £106.19          |
|                         | OJSSL4010      | 10.0               | 4.0               | 6.0               |              |                                      |                         |  |   |                  |                    | 500          | £113.24          |
|                         | OJSSL4012      | 12.0               | 6.0               | 8.0               |              |                                      |                         |  |   |                  |                    | 500          | £118.36          |
|                         | OJSSL4016      | 16.0               | 10.0              | 12.0              |              |                                      |                         |  |   |                  |                    | 500          | £147.10          |
| 4.8                     | OJSSL480816    | 8.0                | 2.5               | 4.0               | 4.9          | 16.0                                 | 1.7                     | 3.00                                       | 28.0                                    | 4230             | 5335               | 250          | £153.53          |
|                         | OJSSL481016    | 10.0               | 4.0               | 6.0               |              |                                      |                         |  |   |                  |                    | 250          | £162.49          |
|                         | OJSSL481216    | 12.0               | 6.0               | 8.0               |              |                                      |                         |  |   |                  |                    | 250          | £169.70          |
|                         | OJSSL481416    | 14.0               | 8.0               | 9.5               |              |                                      |                         |  |   |                  |                    | 250          | £185.57          |
|                         | OJSSL481616    | 16.0               | 9.5               | 11.0              |              |                                      |                         |  |   |                  |                    | 250          | £195.04          |
|                         | OJSSL482016    | 20.0               | 12.0              | 15.0              |              |                                      |                         |  |   |                  |                    | 250          | £227.49          |
|                         | OJSSL482516    | 25.0               | 16.0              | 20.0              |              |                                      |                         |  |   |                  |                    | 200          | £314.00          |

Grip range and test data are guide figures only

# DOME HEAD OPEN BLIND RIVET

- **BODY:** A4 Stainless Steel (AISI316)
- **MANDREL:** A4 Stainless Steel (AISI316) (Grooved)

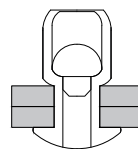
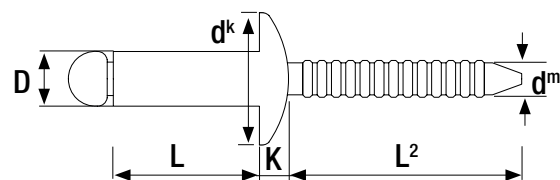

| Nominal Diameter mm (D) | Article Number | Body Length mm (L) | Grip Range Min mm | Grip Range Max mm | Hole Size mm | Flange Diameter mm (d <sup>k</sup> ) | Flange Thickness mm (K) | Nom. Mandrel Diameter mm (d <sup>m</sup> ) | Min Mandrel Length mm (L <sup>2</sup> ) | Shear Strength N | Tensile Strength N | Box Quantity | Price £ Per 1000 |
|-------------------------|----------------|--------------------|-------------------|-------------------|--------------|--------------------------------------|-------------------------|--|---|------------------|--------------------|--------------|------------------|
| 3.2                     | OJSS4D3206     | 6.0                | 1.0               | 3.0               | 3.3          | 6.5                                  | 0.8                     | 2.00                                       | 26.0                                    | 1800             | 2500               | 1000         | £68.49           |
|                         | OJSS4D3208     | 8.0                | 3.0               | 5.0               |              |                                      |                         |  |   |                  |                    | 1000         | £66.64           |
|                         | OJSS4D3210     | 10.0               | 5.0               | 7.0               |              |                                      |                         |  |   |                  |                    | 1000         | £74.07           |
|                         | OJSS4D3212     | 12.0               | 7.0               | 9.0               |              |                                      |                         |  |   |                  |                    | 1000         | £75.25           |
| 4.0                     | OJSS4D4006     | 6.0                | 1.0               | 2.5               | 4.1          | 8.0                                  | 1.0                     | 2.50                                       | 27.0                                    | 3100             | 3800               | 1000         | £94.18           |
|                         | OJSS4D4008     | 8.0                | 2.5               | 4.5               |              |                                      |                         |  |   |                  |                    | 800          | £101.02          |
|                         | OJSS4D4010     | 10.0               | 4.5               | 6.5               |              |                                      |                         |  |   |                  |                    | 800          | £108.84          |
|                         | OJSS4D4013     | 13.0               | 6.5               | 9.5               |              |                                      |                         |  |   |                  |                    | 500          | £117.38          |
|                         | OJSS4D4016     | 16.0               | 9.5               | 12.0              |              |                                      |                         |  |   |                  |                    | 500          | £132.41          |
|                         | OJSS4D4018     | 18.0               | 12.0              | 14.0              |              |                                      |                         |  |   |                  |                    | 500          | £157.77          |
|                         | OJSS4D4020     | 20.0               | 14.0              | 16.0              |              |                                      |                         |  |   |                  |                    | 500          | £169.88          |
| 4.8                     | OJSS4D4808     | 8.0                | 1.5               | 4.0               | 4.9          | 9.5                                  | 1.1                     | 2.90                                       | 28.0                                    | 4500             | 6000               | 500          | £135.35          |
|                         | OJSS4D4810     | 10.0               | 4.0               | 6.0               |              |                                      |                         |  |   |                  |                    | 500          | £150.55          |
|                         | OJSS4D4812     | 12.0               | 6.0               | 8.0               |              |                                      |                         |  |   |                  |                    | 500          | £155.63          |
|                         | OJSS4D4814     | 14.0               | 8.0               | 9.5               |              |                                      |                         |  |   |                  |                    | 500          | £162.53          |
|                         | OJSS4D4816     | 16.0               | 9.5               | 11.0              |              |                                      |                         |  |   |                  |                    | 400          | £180.25          |
|                         | OJSS4D4818     | 18.0               | 11.0              | 13.0              |              |                                      |                         |  |   |                  |                    | 400          | £202.05          |
|                         | OJSS4D4820     | 20.0               | 13.0              | 16.0              |              |                                      |                         |  |   |                  |                    | 350          | £220.36          |
|                         | OJSS4D4822     | 22.0               | 15.0              | 17.0              |              |                                      |                         |  |   |                  |                    | 300          | £232.22          |
|                         | OJSS4D4825     | 25.0               | 17.0              | 20.0              |              |                                      |                         |  |   |                  |                    | 250          | £239.68          |

# DOME HEAD MULTIGRIP BLIND RIVET

- **BODY:** Aluminium (AlMg2.5)
- **MANDREL:** Steel Zinc&Clr Tri3

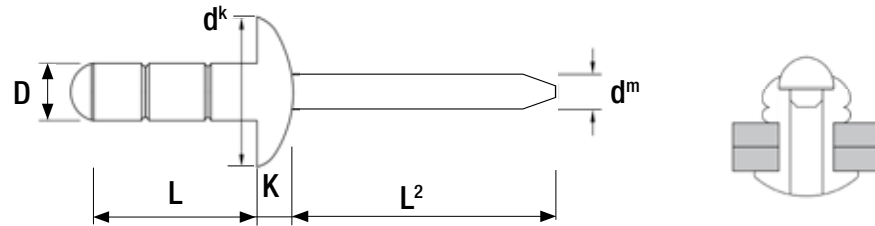

| Nominal Diameter mm (D) | Article Number | Body Length mm (L) | Grip Range Min mm | Grip Range Max mm | Hole Size mm | Flange Diameter mm (d <sup>k</sup> ) | Flange Thickness mm (K) | Nom. Mandrel Diameter mm (d <sup>m</sup> ) | Min Mandrel Length mm (L <sup>2</sup> ) | Shear Strength N | Tensile Strength N | Box Quantity | Price £ Per 1000 |
|-------------------------|----------------|--------------------|-------------------|-------------------|--------------|--------------------------------------|-------------------------|--|---|------------------|--------------------|--------------|------------------|
| <b>3.2</b>              | OJASDM3208     | 8.0                | 0.5               | 4.8               | 3.3          | 6.0                                  | 1.4                     | 1.78                                       | 26.0                                    | 680              | 980                | 1000         | £21.27           |
|                         | OJASDM3209     | 9.5                | 2.0               | 6.4               |              |                                      |                         |  |   |                  |                    | 1000         | £21.97           |
|                         | OJASDM3212     | 12.0               | 4.5               | 9.0               |              |                                      |                         |  |   |                  |                    | 750          | £25.85           |
|                         | OJASDM3214     | 14.0               | 6.5               | 10.5              |              |                                      |                         |  |   |                  |                    | 750          | £28.21           |
| <b>4.0</b>              | OJASDM4008     | 8.0                | 1.0               | 5.0               | 4.1          | 8.0                                  | 1.7                     | 2.18                                       | 27.0                                    | 1150             | 1600               | 750          | £21.86           |
|                         | OJASDM4010     | 10.0               | 1.5               | 6.4               |              |                                      |                         |  |   |                  |                    | 500          | £26.20           |
|                         | OJASDM4013     | 13.0               | 4.0               | 9.5               |              |                                      |                         |  |   |                  |                    | 500          | £29.55           |
|                         | OJASDM4016     | 16.0               | 7.5               | 11.1              |              |                                      |                         |  |   |                  |                    | 500          | £34.10           |
|                         | OJASDM4018     | 18.0               | 9.0               | 14.0              |              |                                      |                         |  |   |                  |                    | 500          | £39.52           |
| <b>4.8</b>              | OJASDM4810     | 10.0               | 1.0               | 5.0               | 4.9          | 9.5                                  | 2.0                     | 2.78                                       | 28.0                                    | 1500             | 2350               | 500          | £41.69           |
|                         | OJASDM4812     | 12.0               | 3.0               | 7.0               |              |                                      |                         |  |   |                  |                    | 500          | £44.36           |
|                         | OJASDM4815     | 15.0               | 5.0               | 10.0              |              |                                      |                         |  |   |                  |                    | 500          | £47.38           |
|                         | OJASDM4817     | 17.0               | 7.0               | 12.0              |              |                                      |                         |  |   |                  |                    | 400          | £49.37           |
|                         | OJASDM4824     | 24.0               | 14.5              | 18.5              |              |                                      |                         |  |   |                  |                    | 250          | £57.82           |
|                         | OJASDM4830     | 30.0               | 18.5              | 24.5              |              |                                      |                         |  |   |                  |                    | 200          | £70.79           |

*Grip range and test data are guide figures only*

# DOME HEAD MULTIGRIP COLOURED BLIND RIVET

- **BODY:** Aluminium (AlMg2.5)
- **MANDREL:** Steel Zinc&Clr Tri3

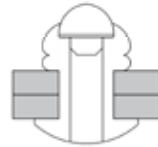
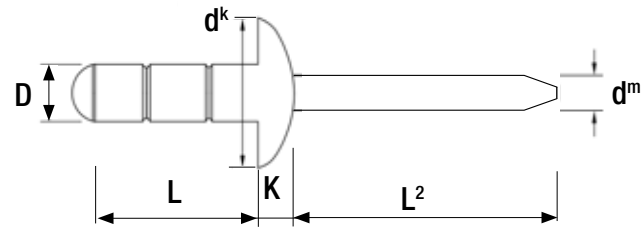

BS18B17 ALBATROSS

| Nominal Diameter mm (D) | Body Length mm (L) | Grip Range Min mm | Grip Range Max mm | Hole Size mm | Flange Diameter mm (d <sup>k</sup> ) | Flange Thickness mm (K) | Nom. Mandrel Diameter mm (d <sup>m</sup> ) | Min Mandrel Length mm (L <sup>2</sup> ) | Shear Strength N | Tensile Strength N | Box Quantity | Price £ Per 1000 |
|-------------------------|--------------------|-------------------|-------------------|--------------|--------------------------------------|-------------------------|--|---|------------------|--------------------|--------------|------------------|
| 4.8                     | 15.0               | 5.0               | 10.0              | 4.9          | 9.5                                  | 2.0                     | 2.78                                       | 28.0                                    | 1500             | 2350               | 500          | £44.53           |

| Colour Swatch Ref | Stock Item Description  | Article Number |
|-------------------|-------------------------|----------------|
|                   | BS18B17 ALBATROSS       | OJCLASDM4815AL |
|                   | RAL7016 ANTHRACITE GREY | OJCLASDM4815AG |
|                   | BS10E55 AZTEC YELLOW    | OJCLASDM4815AZ |
|                   | RAL5015 BAHAMA BLUE     | OJCLASDM4815BB |
|                   | BS08C35 BAMB00          | OJCLASDM4815BA |
|                   | RAL9005 BLACK           | OJCLASDM4815BL |
|                   | RAL3004 BURANO          | OJCLASDM4815BU |
|                   | RAL7038 GOOSEWING GREY  | OJCLASDM4815GG |
|                   | RAL9002 HAMLET          | OJCLASDM4815HA |



RAL7016 ANTHRACITE GREY

BS10E55 AZTEC YELLOW

RAL5015 BAHAMA BLUE

BS08C35 BAMB00

RAL9005 BLACK

RAL3004 BURANO

RAL7038 GOOSEWING GREY

RAL9002 HAMLET

Any RAL or BS specification colours not listed are available to order subject to MOQ's.



# DOME HEAD MULTIGRIP COLOURED BLIND RIVET

- **BODY:** Aluminium (AlMg2.5)
- **MANDREL:** Steel Zinc&Clr Tri3

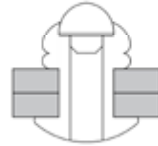
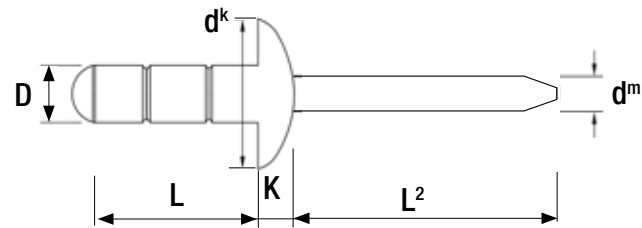

RAL6002 HERITAGE GREEN

| Nominal Diameter mm (D) | Body Length mm (L) | Grip Range Min mm | Grip Range Max mm | Hole Size mm | Flange Diameter mm (d <sup>k</sup> ) | Flange Thickness mm (K) | Nom. Mandrel Diameter mm (d <sup>m</sup> ) | Min Mandrel Length mm (L <sup>2</sup> ) | Shear Strength N | Tensile Strength N | Box Quantity | Price £ Per 1000 |
|-------------------------|--------------------|-------------------|-------------------|--------------|--------------------------------------|-------------------------|--|---|------------------|--------------------|--------------|------------------|
| 4.8                     | 15.0               | 5.0               | 10.0              | 4.9          | 9.5                                  | 2.0                     | 2.78                                       | 28.0                                    | 1500             | 2350               | 500          | £44.53           |

| Colour Swatch Ref | Stock Item Description | Article Number |
|-------------------|------------------------|----------------|
|                   | RAL6002 HERITAGE GREEN | OJCLASDM4815HG |
|                   | BS10C31 HONESTY        | OJCLASDM4815HO |
|                   | BS14C37 JADE           | OJCLASDM4815JA |
|                   | BS12B29 JUNIPER GREEN  | OJCLASDM4815JG |
|                   | BS12B17 MEADOWLAND     | OJCLASDM4815ME |
|                   | BS18B25 MERLIN GREY    | OJCLASDM4815MG |
|                   | BS12B21 MOORLAND GREEN | OJCLASDM4815MO |
|                   | BS10B19 MUSHROOM       | OJCLASDM4815MU |
|                   | BS18C39 OCEAN BLUE     | OJCLASDM4815OB |



BS10C31 HONESTY



BS14C37 JADE



BS12B29 JUNIPER GREEN



BS12B17 MEADOWLAND



BS18B25 MERLIN GREY



BS12B21 MOORLAND GREEN



BS10B19 MUSHROOM



BS18C39 OCEAN BLUE

Any RAL or BS specification colours not listed are available to order subject to MOQ's.

Grip range and test data are guide figures only



# DOME HEAD MULTIGRIP COLOURED BLIND RIVET

- **BODY:** Aluminium (AlMg2.5)
- **MANDREL:** Steel Zinc&Clr Tri3

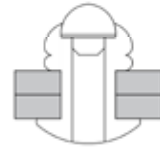
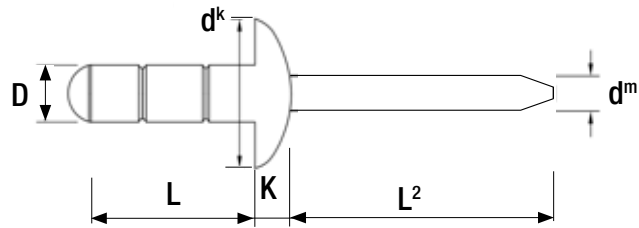

BS12B27 OLIVE GREEN

| Nominal Diameter mm (D) | Body Length mm (L) | Grip Range Min mm | Grip Range Max mm | Hole Size mm | Flange Diameter mm (d <sup>k</sup> ) | Flange Thickness mm (K) | Nom. Mandrel Diameter mm (d <sup>m</sup> ) | Min Mandrel Length mm (L <sup>2</sup> ) | Shear Strength N | Tensile Strength N | Box Quantity | Price £ Per 1000 |
|-------------------------|--------------------|-------------------|-------------------|--------------|--------------------------------------|-------------------------|--|---|------------------|--------------------|--------------|------------------|
| 4.8                     | 15.0               | 5.0               | 10.0              | 4.9          | 9.5                                  | 2.0                     | 2.78                                       | 28.0                                    | 1500             | 2350               | 500          | £44.53           |

| Colour Swatch Ref | Stock Item Description | Article Number |
|-------------------|------------------------|----------------|
|                   | BS12B27 OLIVE GREEN    | OJCLASDM48150G |
|                   | RAL7035 OYSTER         | OJCLASDM48150Y |
|                   | BS04D44 PETRA          | OJCLASDM4815PE |
|                   | BS14C39 PINEWOOD       | OJCLASDM4815PI |
|                   | BS04E53 POPPY RED      | OJCLASDM4815PR |
|                   | BS08E53 SAFFRON        | OJCLASDM4815SF |
|                   | RAL5003 SARGASSO       | OJCLASDM4815SR |
|                   | BS18E53 SOLENT BLUE    | OJCLASDM4815SB |



RAL7035 OYSTER



BS04D44 PETRA



BS14C39 PINEWOOD



BS04E53 POPPY RED



BS08E53 SAFFRON



RAL5003 SARGASSO



BS18E53 SOLENT BLUE

Any RAL or BS specification colours not listed are available to order subject to MOQ's.



# DOME HEAD MULTIGRIP COLOURED BLIND RIVET

● **BODY:** Aluminium (AlMg2.5)

● **MANDREL:** Steel Zinc&Clr Tri3

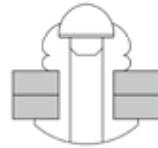
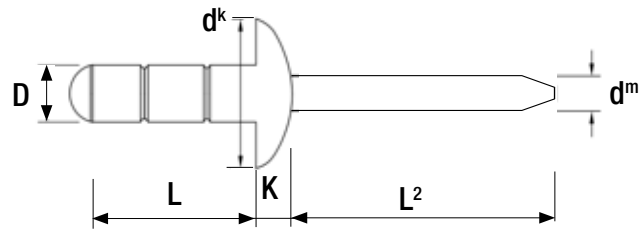

RAL7015 SLATE GREY

| Nominal Diameter mm (D) | Body Length mm (L) | Grip Range Min mm | Grip Range Max mm | Hole Size mm | Flange Diameter mm (d <sup>k</sup> ) | Flange Thickness mm (K) | Nom. Mandrel Diameter mm (d <sup>m</sup> ) | Min Mandrel Length mm (L <sup>2</sup> ) | Shear Strength N | Tensile Strength N | Box Quantity | Price £ Per 1000 |
|-------------------------|--------------------|-------------------|-------------------|--------------|--------------------------------------|-------------------------|--|---|------------------|--------------------|--------------|------------------|
| 4.8                     | 15.0               | 5.0               | 10.0              | 4.9          | 9.5                                  | 2.0                     | 2.78                                       | 28.0                                    | 1500             | 2350               | 500          | £44.53           |

| Colour Swatch Ref | Stock Item Description  | Article Number |
|-------------------|-------------------------|----------------|
|                   | RAL7015 SLATE GREY      | OJCLASDM4815SL |
|                   | BS10B23 SVELTE GREY     | OJCLASDM4815SG |
|                   | BS06E53 TANGERINE       | OJCLASDM4815TA |
|                   | BS04C39 TERRACOTTA      | OJCLASDM4815TE |
|                   | BS08B29 VANDYKE BROWN   | OJCLASDM4815VB |
|                   | BS18C37 WEDGWOOD BLUE   | OJCLASDM4815WB |
|                   | RAL9016 BRILLIANT WHITE | OJCLASDM4815BW |
|                   | RAL9006 SILVER          | OJCLASDM4815SI |



BS10B23 SVELTE GREY



BS06E53 TANGERINE



BS04C39 TERRACOTTA



BS08B29 VANDYKE BROWN



BS18C37 WEDGWOOD BLUE



RAL9016 BRILLIANT WHITE



RAL9006 SILVER

Any RAL or BS specification colours not listed are available to order subject to MOQ's.

Grip range and test data are guide figures only

# COUNTERSUNK HEAD MULTIGRIP BLIND RIVET

● **BODY:** Aluminium (AlMg2.5)

● **MANDREL:** Steel Zinc&Clr Tri3

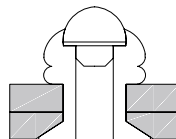
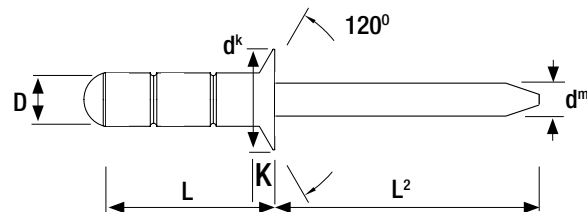

| Nominal Diameter mm (D) | Article Number | Body Length mm (L) | Grip Range Min mm | Grip Range Max mm | Hole Size mm | Flange Diameter mm (d <sup>k</sup> ) | Flange Thickness mm (K) | Nom. Mandrel Diameter mm (d <sup>m</sup> ) | Min Mandrel Length mm (L <sup>2</sup> ) | Shear Strength N | Tensile Strength N | Box Quantity | Price £ Per 1000 |
|-------------------------|----------------|--------------------|-------------------|-------------------|--------------|--------------------------------------|-------------------------|--|---|------------------|--------------------|--------------|------------------|
| 3.2                     | OJASKM3210     | 10.0               | 2.5               | 6.4               | 3.3          | 6.0                                  | 1.1                     | 1.78                                       | 26.0                                    | 680              | 980                | 1000         | £25.02           |
|                         | OJASKM3212     | 12.0               | 4.5               | 9.0               |              |                                      |                         |  |   |                  |                    | 750          | £29.51           |
|                         | OJASKM3214     | 14.0               | 6.5               | 10.5              |              |                                      |                         |  |   |                  |                    | 1000         | £31.86           |
|                         | OJASKM3216     | 16.0               | 8.5               | 12.5              |              |                                      |                         |  |   |                  |                    | 750          | £33.04           |
| 4.0                     | OJASKM4008     | 8.0                | 1.5               | 4.5               | 4.1          | 8.0                                  | 1.4                     | 2.18                                       | 27.0                                    | 1150             | 1600               | 750          | £24.62           |
|                         | OJASKM4011     | 11.3               | 2.5               | 7.5               |              |                                      |                         |  |   |                  |                    | 750          | £27.91           |
|                         | OJASKM4016     | 16.0               | 7.0               | 12.0              |              |                                      |                         |  |   |                  |                    | 500          | £38.46           |
|                         | OJASKM4020     | 20.0               | 11.0              | 16.0              |              |                                      |                         |  |   |                  |                    | 500          | £41.46           |
| 4.8                     | OJASKM4810     | 10.0               | 1.0               | 5.0               | 4.9          | 9.5                                  | 1.8                     | 2.78                                       | 28.0                                    | 1500             | 2350               | 500          | £43.94           |
|                         | OJASKM4812     | 12.0               | 2.0               | 7.0               |              |                                      |                         |  |   |                  |                    | 500          | £46.29           |
|                         | OJASKM4817     | 17.0               | 7.0               | 12.0              |              |                                      |                         |  |   |                  |                    | 250          | £55.71           |
|                         | OJASKM4822     | 22.0               | 12.0              | 17.0              |              |                                      |                         |  |   |                  |                    | 250          | £59.89           |

# LARGE FLANGE HEAD MULTIGRIP BLIND RIVET

- **BODY:** Aluminium (AlMg2.5)
- **MANDREL:** Steel Zinc&Clr Tri3

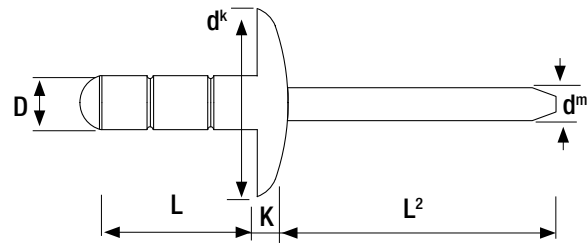

| Nominal Diameter mm (D) | Article Number | Body Length mm (L) | Grip Range Min mm | Grip Range Max mm | Hole Size mm | Flange Diameter mm (d <sup>k</sup> ) | Flange Thickness mm (K) | Nom. Mandrel Diameter mm (d <sup>m</sup> ) | Min Mandrel Length mm (L <sup>2</sup> ) | Shear Strength N | Tensile Strength N | Box Quantity | Price £ Per 1000 |
|-------------------------|----------------|--------------------|-------------------|-------------------|--------------|--------------------------------------|-------------------------|--|---|------------------|--------------------|--------------|------------------|
| 3.2                     | OJASLM3208     | 8.0                | 1.0               | 5.0               | 3.3          | 9.5                                  | 2.0                     | 1.78                                       | 26.0                                    | 680              | 980                | 500          | £33.54           |
|                         | OJASLM3209     | 9.5                | 1.3               | 6.4               |              |                                      |                         |  |   |                  |                    | 500          | £34.44           |
|                         | OJASLM3212     | 12.0               | 4.5               | 9.0               |              |                                      |                         |  |   |                  |                    | 500          | £36.44           |
|                         | OJASLM3216     | 16.0               | 8.5               | 12.5              |              |                                      |                         |  |   |                  |                    | 500          | £38.74           |
| 4.0                     | OJASLM4010     | 10.0               | 1.5               | 6.5               | 4.1          | 12.0                                 | 2.5                     | 2.18                                       | 27.0                                    | 1150             | 1600               | 500          | £44.54           |
|                         | OJASLM4012     | 12.7               | 3.5               | 8.5               |              |                                      |                         |  |   |                  |                    | 500          | £46.90           |
|                         | OJASLM4017     | 17.0               | 7.5               | 12.5              |              |                                      |                         |  |   |                  |                    | 400          | £49.32           |
|                         | OJASLM4020     | 20.0               | 11.5              | 15.5              |              |                                      |                         |  |   |                  |                    | 250          | £70.43           |
| 4.8                     | OJASLM481016   | 10.0               | 1.0               | 5.0               | 4.9          | 16.0                                 | 2.5                     | 2.78                                       | 28.0                                    | 1500             | 2350               | 250          | £63.39           |
|                         | OJASLM481216   | 12.0               | 3.0               | 7.0               |              |                                      |                         |  |   |                  |                    | 250          | £66.59           |
|                         | OJASLM481416   | 14.0               | 5.0               | 9.0               |              |                                      |                         |  |   |                  |                    | 250          | £69.13           |
|                         | OJASLM481716   | 17.0               | 8.0               | 12.0              |              |                                      |                         |  |   |                  |                    | 250          | £72.65           |
|                         | OJASLM482016   | 20.0               | 11.0              | 14.5              |              |                                      |                         |  |   |                  |                    | 250          | £75.96           |
|                         | OJASLM482416   | 24.8               | 16.0              | 19.0              |              |                                      |                         |  |   |                  |                    | 200          | £83.40           |

Grip range and test data are guide figures only

# DOME HEAD MULTIGRIP BLIND RIVET

- **BODY:** Aluminium (AlMg2.5)
- **MANDREL:** A2 Stainless Steel (AISI304)

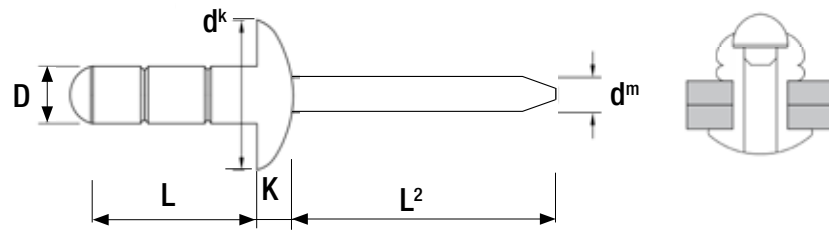

| Nominal Diameter mm (D) | Article Number | Body Length mm (L) | Grip Range Min mm | Grip Range Max mm | Hole Size mm | Flange Diameter mm (d <sup>h</sup> ) | Flange Thickness mm (K) | Nom. Mandrel Diameter mm (d <sup>m</sup> ) | Min Mandrel Length mm (L <sup>2</sup> ) | Shear Strength N | Tensile Strength N | Box Quantity | Price £ Per 1000 |
|-------------------------|----------------|--------------------|-------------------|-------------------|--------------|--------------------------------------|-------------------------|--|---|------------------|--------------------|--------------|------------------|
| 3.2                     | OJASSDM3208    | 8.0                | 1.0               | 4.8               | 3.3          | 6.0                                  | 1.4                     | 1.78                                       | 26.0                                    | 680              | 980                | 1000         | £47.89           |
|                         | OJASSDM3209    | 9.5                | 2.0               | 6.4               |              |                                      |                         |  |   |                  |                    | 1000         | £53.02           |
|                         | OJASSDM3212    | 12.5               | 4.5               | 9.0               |              |                                      |                         |  |   |                  |                    | 1000         | £58.16           |
| 4.0                     | OJASSDM4009    | 9.5                | 2.0               | 5.5               | 4.1          | 8.0                                  | 1.7                     | 2.18                                       | 27.0                                    | 1150             | 1600               | 500          | £73.59           |
|                         | OJASSDM4012    | 12.7               | 3.5               | 8.0               |              |                                      |                         |  |   |                  |                    | 500          | £78.72           |
|                         | OJASSDM4016    | 16.9               | 6.0               | 12.5              |              |                                      |                         |  |   |                  |                    | 500          | £85.53           |
| 4.8                     | OJASSDM4810    | 10.3               | 1.0               | 5.0               | 4.9          | 9.5                                  | 2.0                     | 2.78                                       | 28.0                                    | 1500             | 2530               | 500          | £95.82           |
|                         | OJASSDM4812    | 12.5               | 3.0               | 7.5               |              |                                      |                         |  |   |                  |                    | 500          | £100.96          |
|                         | OJASSDM4815    | 15.0               | 5.0               | 10.0              |              |                                      |                         |  |   |                  |                    | 500          | £104.05          |
|                         | OJASSDM4816    | 16.9               | 7.0               | 12.0              |              |                                      |                         |  |   |                  |                    | 500          | £106.11          |
|                         | OJASSDM4820    | 20.0               | 10.0              | 15.0              |              |                                      |                         |  |   |                  |                    | 500          | £116.38          |
|                         | OJASSDM4824    | 24.8               | 12.7              | 19.5              |              |                                      |                         |  |   |                  |                    | 250          | £142.10          |



# DOME HEAD MULTIGRIP BLIND RIVET

- BODY:** Steel Zinc&Clr Tri3
- MANDREL:** Steel Zinc&Clr Tri3 (Grooved)

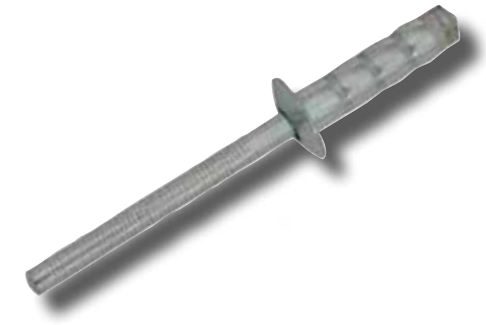
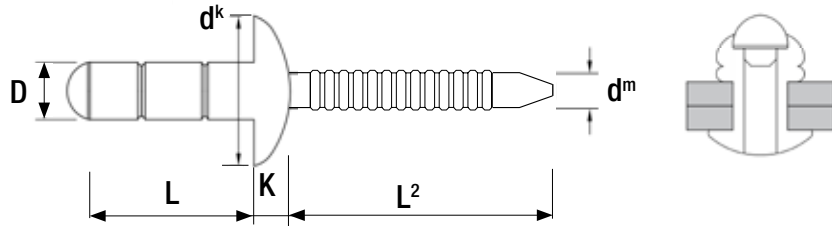

| Nominal Diameter mm (D) | Article Number | Body Length mm (L) | Grip Range Min mm | Grip Range Max mm | Hole Size mm | Flange Diameter mm (d <sup>k</sup> ) | Flange Thickness mm (K) | Nom. Mandrel Diameter mm (d <sup>m</sup> ) | Min Mandrel Length mm (L <sup>2</sup> ) | Shear Strength N | Tensile Strength N | Box Quantity | Price £ Per 1000 |
|-------------------------|----------------|--------------------|-------------------|-------------------|--------------|--------------------------------------|-------------------------|--|---|------------------|--------------------|--------------|------------------|
| 3.2                     | OJSDM3209      | 9.0                | 1.1               | 4.0               | 3.3          | 7.2                                  | 1.2                     | 2.10                                       | 26.0                                    | 1200             | 1600               | 1000         | £44.42           |
|                         | OJSDM3212      | 12.0               | 1.1               | 7.0               |              |                                      |                         |  |   |                  |                    | 1000         | £45.90           |
|                         | OJSDM3214      | 14.0               | 6.5               | 9.0               |              |                                      |                         |  |   |                  |                    | 1000         | £48.23           |
| 4.0                     | OJSDM4010      | 10.8               | 1.5               | 4.5               | 4.1          | 8.1                                  | 1.4                     | 2.63                                       | 27.0                                    | 1650             | 2400               | 500          | £54.00           |
|                         | OJSDM4012      | 12.5               | 3.0               | 6.5               |              |                                      |                         |  |   |                  |                    | 500          | £56.82           |
|                         | OJSDM4015      | 15.0               | 5.5               | 8.5               |              |                                      |                         |  |   |                  |                    | 500          | £62.37           |
| 4.8                     | OJSDM4810      | 10.2               | 1.5               | 4.5               | 4.9          | 9.8                                  | 2.0                     | 3.10                                       | 28.0                                    | 2400             | 3200               | 500          | £69.01           |
|                         | OJSDM4812      | 12.7               | 3.5               | 6.3               |              |                                      |                         |  |   |                  |                    | 500          | £72.75           |
|                         | OJSDM4817      | 17.5               | 8.0               | 12.0              |              |                                      |                         |  |   |                  |                    | 400          | £77.80           |

Grip range and test data are guide figures only

# LARGE FLANGE HEAD MULTIGRIP BLIND RIVET

- BODY:** Steel Zinc&Clr Tri3
- MANDREL:** Steel Zinc&Clr Tri3 (Grooved)

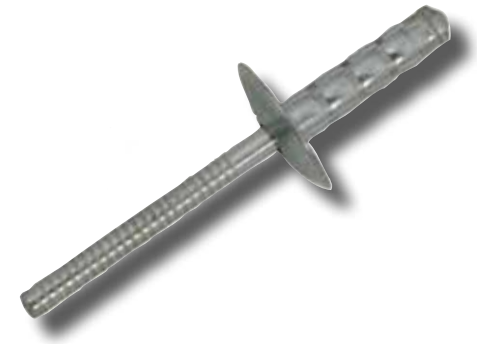
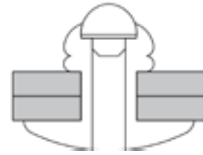
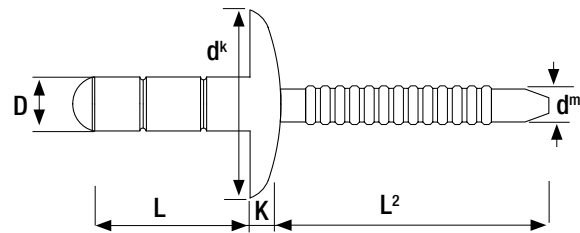

| Nominal Diameter mm (D) | Article Number | Body Length mm (L) | Grip Range Min mm | Grip Range Max mm | Hole Size mm | Flange Diameter mm (d <sup>fl</sup> ) | Flange Thickness mm (K) | Nom. Mandrel Diameter mm (d <sup>m</sup> ) | Min Mandrel Length mm (L <sup>2</sup> ) | Shear Strength N | Tensile Strength N | Box Quantity | Price £ Per 1000 |
|-------------------------|----------------|--------------------|-------------------|-------------------|--------------|---------------------------------------|-------------------------|--|---|------------------|--------------------|--------------|------------------|
| 4.8                     | OJSLM4810      | 10.0               | 1.5               | 4.0               | 4.9          | 16.0                                  | 2.5                     | 3.10                                       | 28.0                                    | 2400             | 3200               | 250          | £89.77           |
|                         | OJSLM4815      | 15.0               | 6.0               | 9.5               |              |                                       |                         |  |   |                  |                    | 250          | £101.87          |
|                         | OJSLM4817      | 17.5               | 8.0               | 12.0              |              |                                       |                         |  |   |                  |                    | 250          | £101.24          |

# DOME HEAD MULTIGRIP BLIND RIVET

- BODY:** A2 Stainless Steel (AISI304)
- MANDREL:** A2 Stainless Steel (AISI304) (Grooved)

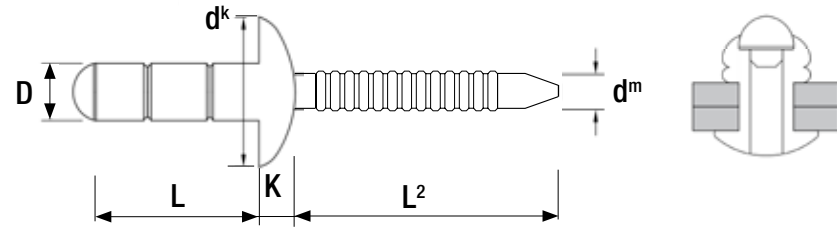

| Nominal Diameter mm (D) | Article Number | Body Length mm (L) | Grip Range Min mm | Grip Range Max mm | Hole Size mm | Flange Diameter mm (d <sup>k</sup> ) | Flange Thickness mm (K) | Nom. Mandrel Diameter mm (d <sup>m</sup> ) | Min Mandrel Length mm (L <sup>2</sup> ) | Shear Strength N | Tensile Strength N | Box Quantity | Price £ Per 1000 |
|-------------------------|----------------|--------------------|-------------------|-------------------|--------------|--------------------------------------|-------------------------|--|---|------------------|--------------------|--------------|------------------|
| <b>3.2</b>              | OJSSDM3208     | 8.0                | 1.0               | 4.0               | 3.3          | 7.3                                  | 1.1                     | 2.00                                       | 26.0                                    | 1450             | 2300               | 1000         | £104.33          |
|                         | OJSSDM3210     | 10.0               | 3.0               | 6.0               |              |                                      |                         |  |   |                  |                    | 1000         | £113.20          |
|                         | OJSSDM3212     | 12.0               | 4.0               | 7.0               |              |                                      |                         |  |   |                  |                    | 750          | £138.55          |
| <b>4.0</b>              | OJSSDM4010     | 10.0               | 1.5               | 5.0               | 4.1          | 8.1                                  | 1.2                     | 2.60                                       | 27.0                                    | 2650             | 3600               | 500          | £148.73          |
|                         | OJSSDM4012     | 12.0               | 3.5               | 7.0               |              |                                      |                         |  |   |                  |                    | 500          | £151.82          |
|                         | OJSSDM4015     | 15.0               | 6.0               | 9.0               |              |                                      |                         |  |   |                  |                    | 500          | £162.77          |
| <b>4.8</b>              | OJSSDM4810     | 10.0               | 1.5               | 4.5               | 4.9          | 9.8                                  | 1.8                     | 3.20                                       | 28.0                                    | 4000             | 5000               | 500          | £186.40          |
|                         | OJSSDM4812     | 12.0               | 3.0               | 6.5               |              |                                      |                         |  |   |                  |                    | 500          | £204.56          |
|                         | OJSSDM4815     | 15.0               | 6.5               | 9.0               |              |                                      |                         |  |   |                  |                    | 250          | £214.27          |
|                         | OJSSDM4817     | 17.5               | 9.0               | 12.5              |              |                                      |                         |  |   |                  |                    | 250          | £229.79          |
| <b>6.4</b>              | OJSSDM6413     | 13.0               | 3.5               | 5.5               | 6.5          | 12.7                                 | 2.2                     | 3.85                                       | 32.0                                    | 7800             | 8800               | 200          | £365.85          |
|                         | OJSSDM6416     | 16.0               | 5.0               | 9.0               |              |                                      |                         |  |   |                  |                    | 200          | £436.74          |
|                         | OJSSDM6420     | 20.0               | 5.5               | 12.5              |              |                                      |                         |  |   |                  |                    | 200          | £496.54          |

Also available in retail bags. See page 83.

Grip range and test data are guide figures only

# DOME HEAD SEALED BLIND RIVET

- **BODY:** Aluminium (AlMg5)
- **MANDREL:** Steel Phosphated

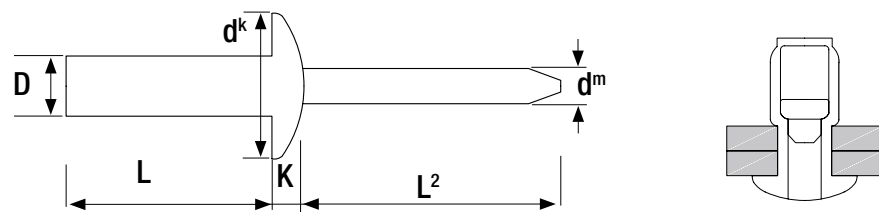

| Nominal Diameter mm (D) | Article Number | Body Length mm (L) | Grip Range Min mm | Grip Range Max mm | Hole Size mm | Flange Diameter mm (d <sup>k</sup> ) | Flange Thickness mm (K) | Nom. Mandrel Diameter mm (d <sup>m</sup> ) | Min Mandrel Length mm (L <sup>2</sup> ) | Shear Strength N | Tensile Strength N | Box Quantity | Price £ Per 1000 |
|-------------------------|----------------|--------------------|-------------------|-------------------|--------------|--------------------------------------|-------------------------|--|---|------------------|--------------------|--------------|------------------|
| 3.2                     | OJASDS3206     | 6.5                | 0.5               | 2.0               | 3.3          | 6.0                                  | 1.4                     | 1.70                                       | 26.0                                    | 1070             | 1245               | 1000         | £28.44           |
|                         | OJASDS3208     | 8.0                | 2.0               | 3.5               |              |                                      |                         |  |   |                  |                    | 1000         | £29.09           |
|                         | OJASDS3209     | 9.5                | 3.5               | 5.0               |              |                                      |                         |  |   |                  |                    | 1000         | £30.56           |
|                         | OJASDS3210     | 10.5               | 5.0               | 6.5               |              |                                      |                         |  |   |                  |                    | 1000         | £32.03           |
|                         | OJASDS3212     | 12.5               | 6.5               | 8.0               |              |                                      |                         |  |   |                  |                    | 750          | £34.58           |
| 4.0                     | OJASDS4008     | 8.0                | 1.0               | 3.5               | 4.1          | 8.0                                  | 1.7                     | 2.18                                       | 27.0                                    | 1710             | 2240               | 750          | £34.40           |
|                         | OJASDS4009     | 9.5                | 3.5               | 5.0               |              |                                      |                         |  |   |                  |                    | 750          | £38.22           |
|                         | OJASDS4011     | 11.0               | 4.5               | 6.5               |              |                                      |                         |  |   |                  |                    | 750          | £41.46           |
|                         | OJASDS4012     | 12.5               | 6.5               | 8.0               |              |                                      |                         |  |   |                  |                    | 500          | £42.28           |
|                         | OJASDS4015     | 15.0               | 8.0               | 10.5              |              |                                      |                         |  |   |                  |                    | 500          | £43.88           |
| 4.8                     | OJASDS4808     | 8.0                | 1.0               | 3.0               | 4.9          | 9.5                                  | 2.0                     | 2.63                                       | 28.0                                    | 2230             | 3070               | 500          | £46.95           |
|                         | OJASDS4809     | 9.5                | 3.0               | 4.5               |              |                                      |                         |  |   |                  |                    | 500          | £50.36           |
|                         | OJASDS4810     | 10.0               | 3.0               | 5.0               |              |                                      |                         |  |   |                  |                    | 500          | £51.55           |
|                         | OJASDS4811     | 11.0               | 4.5               | 6.0               |              |                                      |                         |  |   |                  |                    | 500          | £51.93           |
|                         | OJASDS4812     | 12.5               | 6.0               | 7.5               |              |                                      |                         |  |   |                  |                    | 500          | £54.87           |
|                         | OJASDS4814     | 14.0               | 7.5               | 9.0               |              |                                      |                         |  |   |                  |                    | 500          | £58.65           |
|                         | OJASDS4816     | 16.0               | 9.0               | 11.0              |              |                                      |                         |  |   |                  |                    | 250          | £56.53           |
|                         | OJASDS4818     | 18.0               | 11.0              | 13.0              |              |                                      |                         |  |   |                  |                    | 250          | £60.75           |
|                         | OJASDS4821     | 21.0               | 13.0              | 16.0              |              |                                      |                         |  |   |                  |                    | 250          | £68.90           |
|                         | OJASDS4825     | 25.0               | 16.0              | 20.0              |              |                                      |                         |  |   |                  |                    | 250          | £82.07           |
| 6.4                     | OJASDS6412     | 12.5               | 3.0               | 6.0               | 6.5          | 12.7                                 | 2.5                     | 3.70                                       | 32.0                                    | 3950             | 5000               | 250          | £116.31          |
|                         | OJASDS6416     | 16.0               | 6.0               | 9.0               |              |                                      |                         |  |   |                  |                    | 200          | £126.55          |
|                         | OJASDS6420     | 20.0               | 8.0               | 12.5              |              |                                      |                         |  |   |                  |                    | 150          | £148.72          |

# COUNTERSUNK HEAD SEALED BLIND RIVET

- **BODY:** Aluminium (AlMg5)
- **MANDREL:** Steel Phosphated

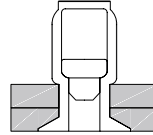
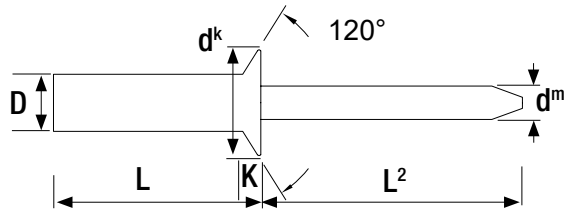

| Nominal Diameter mm (D) | Article Number | Body Length mm (L) | Grip Range Min mm | Grip Range Max mm | Hole Size mm | Flange Diameter mm (d <sup>k</sup> ) | Flange Thickness mm (K) | Nom. Mandrel Diameter mm (d <sup>m</sup> ) | Min Mandrel Length mm (L <sup>2</sup> ) | Shear Strength N | Tensile Strength N | Box Quantity | Price £ Per 1000 |
|-------------------------|----------------|--------------------|-------------------|-------------------|--------------|--------------------------------------|-------------------------|--|---|------------------|--------------------|--------------|------------------|
| <b>3.2</b>              | OJASKS3207     | 7.5                | 1.5               | 3.5               | 3.3          | 6.0                                  | 1.1                     | 1.70                                       | 26.0                                    | 1070             | 1245               | 1000         | £29.09           |
|                         | OJASKS3209     | 9.0                | 3.5               | 4.5               |              |                                      |                         |  |   |                  |                    | 1000         | £31.86           |
|                         | OJASKS3210     | 10.5               | 4.5               | 6.5               |              |                                      |                         |  |   |                  |                    | 1000         | £32.97           |
|                         | OJASKS3212     | 12.0               | 6.0               | 7.5               |              |                                      |                         |  |   |                  |                    | 1000         | £34.74           |
|                         | OJASKS3213     | 13.5               | 7.5               | 9.0               |              |                                      |                         |  |   |                  |                    | 750          | £36.45           |
| <b>4.0</b>              | OJASKS4009     | 9.5                | 2.0               | 4.5               | 4.1          | 7.5                                  | 1.4                     | 2.20                                       | 27.0                                    | 1710             | 2240               | 750          | £38.86           |
|                         | OJASKS4011     | 11.0               | 5.0               | 6.5               |              |                                      |                         |  |   |                  |                    | 750          | £43.23           |
|                         | OJASKS4012     | 12.5               | 6.0               | 8.0               |              |                                      |                         |  |   |                  |                    | 750          | £43.35           |
|                         | OJASKS4014     | 14.0               | 8.0               | 9.5               |              |                                      |                         |  |   |                  |                    | 500          | £45.80           |
| <b>4.8</b>              | OJASKS4809     | 9.5                | 2.5               | 4.5               | 4.9          | 9.5                                  | 1.8                     | 2.65                                       | 28.0                                    | 2230             | 3070               | 500          | £47.51           |
|                         | OJASKS4811     | 11.0               | 4.5               | 6.0               |              |                                      |                         |  |   |                  |                    | 500          | £47.70           |
|                         | OJASKS4812     | 12.5               | 6.0               | 7.5               |              |                                      |                         |  |   |                  |                    | 500          | £52.59           |
|                         | OJASKS4814     | 14.0               | 7.5               | 9.0               |              |                                      |                         |  |   |                  |                    | 500          | £55.48           |
|                         | OJASKS4815     | 15.5               | 9.0               | 10.5              |              |                                      |                         |  |   |                  |                    | 500          | £58.01           |
|                         | OJASKS4819     | 19.0               | 10.5              | 13.0              |              |                                      |                         |  |   |                  |                    | 250          | £61.89           |

Grip range and test data are guide figures only

# DOME HEAD SEALED BLIND RIVET

- **BODY:** Aluminium (AlMg2.5)
- **MANDREL:** Aluminium (AlMg2.5)

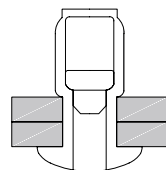
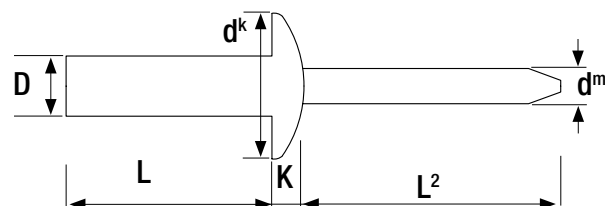

| Nominal Diameter mm (D) | Article Number | Body Length mm (L) | Grip Range Min mm | Grip Range Max mm | Hole Size mm | Flange Diameter mm (d <sup>k</sup> ) | Flange Thickness mm (K) | Nom. Mandrel Diameter mm (d <sup>m</sup> ) | Min Mandrel Length mm (L <sup>2</sup> ) | Shear Strength N | Tensile Strength N | Box Quantity | Price £ Per 1000 |
|-------------------------|----------------|--------------------|-------------------|-------------------|--------------|--------------------------------------|-------------------------|--|---|------------------|--------------------|--------------|------------------|
| <b>3.2</b>              | OJADS3206      | 6.5                | 0.5               | 2.0               | 3.3          | 6.0                                  | 1.4                     | 1.80                                       | 26.0                                    | 450              | 490                | 1000         | <b>£37.79</b>    |
|                         | OJADS3208      | 8.0                | 2.0               | 3.5               |              |                                      |                         |  |   |                  |                    | 1000         | <b>£38.87</b>    |
|                         | OJADS3209      | 9.5                | 3.5               | 5.0               |              |                                      |                         |  |   |                  |                    | 1000         | <b>£39.66</b>    |
|                         | OJADS3210      | 10.7               | 5.0               | 6.5               |              |                                      |                         |  |   |                  |                    | 1000         | <b>£41.19</b>    |
|                         | OJADS3212      | 12.7               | 6.5               | 8.0               |              |                                      |                         |  |   |                  |                    | 1000         | <b>£42.29</b>    |
| <b>4.0</b>              | OJADS4008      | 8.0                | 1.0               | 3.0               | 4.1          | 8.0                                  | 1.7                     | 2.20                                       | 27.0                                    | 580              | 820                | 500          | <b>£51.02</b>    |
|                         | OJADS4009      | 9.5                | 3.5               | 4.5               |              |                                      |                         |  |   |                  |                    | 750          | <b>£53.11</b>    |
|                         | OJADS4012      | 12.5               | 4.5               | 8.0               |              |                                      |                         |  |   |                  |                    | 500          | <b>£57.03</b>    |
| <b>4.8</b>              | OJADS4809      | 9.5                | 3.0               | 4.5               | 4.9          | 9.5                                  | 2.0                     | 2.65                                       | 28.0                                    | 900              | 1120               | 500          | <b>£65.94</b>    |
|                         | OJADS4811      | 11.5               | 4.5               | 6.5               |              |                                      |                         |  |   |                  |                    | 500          | <b>£69.75</b>    |
|                         | OJADS4815      | 15.0               | 6.5               | 9.5               |              |                                      |                         |  |   |                  |                    | 500          | <b>£74.51</b>    |
|                         | OJADS4818      | 18.0               | 9.50              | 13.0              |              |                                      |                         |  |   |                  |                    | 250          | <b>£79.09</b>    |



# DOME HEAD SEALED BLIND RIVET

- **BODY:** Aluminium (AlMg5)
- **MANDREL:** A2 Stainless Steel (AISI304)

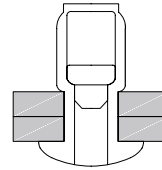
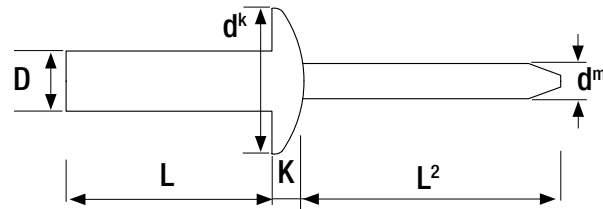

| Nominal Diameter mm (D) | Article Number | Body Length mm (L) | Grip Range Min mm | Grip Range Max mm | Hole Size mm | Flange Diameter mm (d <sup>k</sup> ) | Flange Thickness mm (K) | Nom. Mandrel Diameter mm (d <sup>m</sup> ) | Min Mandrel Length mm (L <sup>2</sup> ) | Shear Strength N | Tensile Strength N | Box Quantity | Price £ Per 1000 |
|-------------------------|----------------|--------------------|-------------------|-------------------|--------------|--------------------------------------|-------------------------|--|---|------------------|--------------------|--------------|------------------|
| 3.2                     | OJASSDS3206    | 6.5                | 0.5               | 2.0               | 3.3          | 6.0                                  | 1.4                     | 1.70                                       | 26.0                                    | 1070             | 1245               | 1000         | £47.89           |
|                         | OJASSDS3208    | 8.0                | 2.0               | 3.5               |              |                                      |                         |  |   |                  |                    | 1000         | £48.90           |
|                         | OJASSDS3209    | 9.5                | 3.5               | 5.0               |              |                                      |                         |  |   |                  |                    | 1000         | £49.93           |
|                         | OJASSDS3211    | 11.0               | 5.5               | 6.5               |              |                                      |                         |  |   |                  |                    | 1000         | £50.97           |
|                         | OJASSDS3212    | 12.5               | 6.5               | 8.0               |              |                                      |                         |  |   |                  |                    | 1000         | £55.08           |
| 4.0                     | OJASSDS4008    | 8.0                | 0.5               | 3.5               | 4.1          | 8.0                                  | 1.7                     | 2.20                                       | 27.0                                    | 1700             | 2240               | 500          | £64.96           |
|                         | OJASSDS4009    | 9.5                | 3.5               | 4.5               |              |                                      |                         |  |   |                  |                    | 500          | £71.45           |
|                         | OJASSDS4011    | 11.0               | 5.0               | 6.5               |              |                                      |                         |  |   |                  |                    | 500          | £75.25           |
|                         | OJASSDS4012    | 12.5               | 6.5               | 8.0               |              |                                      |                         |  |   |                  |                    | 500          | £77.30           |
|                         | OJASSDS4014    | 14.0               | 8.0               | 9.5               |              |                                      |                         |  |   |                  |                    | 500          | £90.67           |
| 4.8                     | OJASSDS4808    | 8.0                | 1.0               | 3.0               | 4.9          | 9.5                                  | 2.0                     | 2.65                                       | 28.0                                    | 2200             | 3100               | 500          | £88.78           |
|                         | OJASSDS4809    | 9.5                | 3.0               | 4.5               |              |                                      |                         |  |   |                  |                    | 500          | £91.87           |
|                         | OJASSDS4811    | 11.0               | 5.0               | 6.0               |              |                                      |                         |  |   |                  |                    | 500          | £102.39          |
|                         | OJASSDS4812    | 12.5               | 6.5               | 7.5               |              |                                      |                         |  |   |                  |                    | 500          | £99.08           |
|                         | OJASSDS4816    | 16.0               | 9.5               | 11.0              |              |                                      |                         |  |   |                  |                    | 500          | £140.21          |
|                         | OJASSDS4818    | 18.0               | 11.0              | 13.0              |              |                                      |                         |  |   |                  |                    | 250          | £160.78          |
|                         | OJASSDS4821    | 21.0               | 13.0              | 16.0              |              |                                      |                         |  |   |                  |                    | 250          | £181.35          |

Grip range and test data are guide figures only

# DOME HEAD SEALED BLIND RIVET

- BODY:** Steel Zinc&Clr Tri3
- MANDREL:** Steel Zinc&Clr Tri3

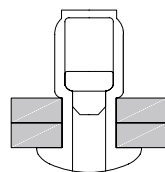
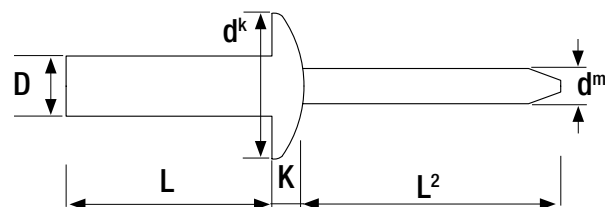

| Nominal Diameter mm (D) | Article Number | Body Length mm (L) | Grip Range Min mm | Grip Range Max mm | Hole Size mm | Flange Diameter mm (d <sup>k</sup> ) | Flange Thickness mm (K) | Nom. Mandrel Diameter mm (d <sup>m</sup> ) | Min Mandrel Length mm (L <sup>2</sup> ) | Shear Strength N | Tensile Strength N | Box Quantity | Price £ Per 1000 |
|-------------------------|----------------|--------------------|-------------------|-------------------|--------------|--------------------------------------|-------------------------|--|---|------------------|--------------------|--------------|------------------|
| <b>3.2</b>              | OJSDS3206      | 6.0                | 0.5               | 1.5               | 3.3          | 6.0                                  | 1.0                     | 1.90                                       | 26.0                                    | 1600             | 2200               | 1000         | £79.38           |
|                         | OJSDS3208      | 8.0                | 1.5               | 3.0               |              |                                      |                         |  |   |                  |                    | 1000         | £80.53           |
|                         | OJSDS3209      | 9.5                | 3.0               | 5.0               |              |                                      |                         |  |   |                  |                    | 1000         | £81.95           |
|                         | OJSDS3212      | 12.0               | 5.0               | 6.5               |              |                                      |                         |  |   |                  |                    | 1000         | £83.68           |
| <b>4.0</b>              | OJSDS4006      | 6.0                | 0.5               | 1.5               | 4.1          | 8.0                                  | 1.4                     | 2.30                                       | 27.0                                    | 2300             | 2500               | 500          | £92.05           |
|                         | OJSDS4008      | 8.0                | 1.5               | 3.0               |              |                                      |                         |  |   |                  |                    | 800          | £92.77           |
|                         | OJSDS4010      | 10.0               | 3.0               | 5.0               |              |                                      |                         |  |   |                  |                    | 800          | £95.21           |
|                         | OJSDS4012      | 12.0               | 5.0               | 6.5               |              |                                      |                         |  |   |                  |                    | 800          | £97.59           |
|                         | OJSDS4015      | 15.0               | 6.5               | 10.5              |              |                                      |                         |  |   |                  |                    | 500          | £106.73          |
| <b>4.8</b>              | OJSDS4808      | 8.0                | 0.5               | 3.0               | 4.9          | 9.5                                  | 1.7                     | 2.90                                       | 28.0                                    | 2900             | 3800               | 500          | £105.59          |
|                         | OJSDS4809      | 9.5                | 3.0               | 5.0               |              |                                      |                         |  |   |                  |                    | 500          | £109.45          |
|                         | OJSDS4812      | 12.0               | 5.0               | 6.5               |              |                                      |                         |  |   |                  |                    | 500          | £112.17          |
|                         | OJSDS4816      | 16.0               | 6.5               | 10.5              |              |                                      |                         |  |   |                  |                    | 400          | £124.91          |

# DOME HEAD SEALED BLIND RIVET

- BODY:** A2 Stainless Steel (AISI304)
- MANDREL:** Stainless Steel (AISI420) (Grooved)

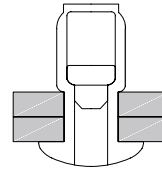
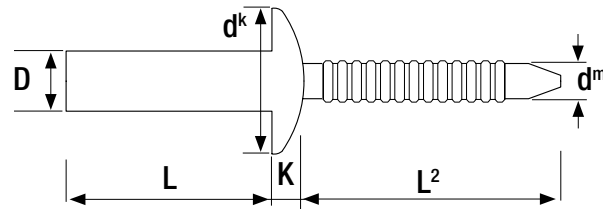

| Nominal Diameter mm (D) | Article Number | Body Length mm (L) | Grip Range Min mm | Grip Range Max mm | Hole Size mm | Flange Diameter mm (d <sup>k</sup> ) | Flange Thickness mm (K) | Nom. Mandrel Diameter mm (d <sup>m</sup> ) | Min Mandrel Length mm (L <sup>2</sup> ) | Shear Strength N | Tensile Strength N | Box Quantity | Price £ Per 1000 |
|-------------------------|----------------|--------------------|-------------------|-------------------|--------------|--------------------------------------|-------------------------|--|---|------------------|--------------------|--------------|------------------|
| 3.2                     | OJSSDS3206     | 6.0                | 0.5               | 1.5               | 3.3          | 6.0                                  | 0.9                     | 1.90                                       | 26.0                                    | 2000             | 2500               | 1000         | £108.04          |
|                         | OJSSDS3208     | 8.0                | 1.5               | 3.0               |              |                                      |                         |  |   |                  |                    | 1000         | £115.13          |
|                         | OJSSDS3209     | 9.5                | 3.0               | 4.5               |              |                                      |                         |  |   |                  |                    | 1000         | £121.30          |
|                         | OJSSDS3212     | 12.0               | 4.5               | 6.5               |              |                                      |                         |  |   |                  |                    | 1000         | £134.62          |
|                         | OJSSDS3214     | 14.0               | 6.5               | 8.0               |              |                                      |                         |  |   |                  |                    | 1000         | £149.03          |
| 4.0                     | OJSSDS4006     | 6.0                | 0.5               | 1.5               | 4.1          | 8.0                                  | 1.3                     | 2.30                                       | 27.0                                    | 3000             | 4000               | 500          | £146.35          |
|                         | OJSSDS4008     | 8.0                | 1.5               | 3.0               |              |                                      |                         |  |   |                  |                    | 800          | £147.68          |
|                         | OJSSDS4009     | 9.5                | 3.0               | 5.0               |              |                                      |                         |  |   |                  |                    | 500          | £153.48          |
|                         | OJSSDS4012     | 12.0               | 5.0               | 6.5               |              |                                      |                         |  |   |                  |                    | 800          | £159.05          |
|                         | OJSSDS4016     | 16.0               | 6.5               | 10.0              |              |                                      |                         |  |   |                  |                    | 500          | £182.99          |
| 4.8                     | OJSSDS4808     | 8.0                | 1.0               | 3.0               | 4.9          | 9.5                                  | 1.6                     | 2.90                                       | 28.0                                    | 4500             | 5500               | 500          | £175.23          |
|                         | OJSSDS4809     | 9.5                | 3.0               | 4.5               |              |                                      |                         |  |   |                  |                    | 500          | £184.46          |
|                         | OJSSDS4812     | 12.0               | 4.5               | 6.0               |              |                                      |                         |  |   |                  |                    | 500          | £189.70          |
|                         | OJSSDS4816     | 16.0               | 6.5               | 9.0               |              |                                      |                         |  |   |                  |                    | 400          | £209.92          |
|                         | OJSSDS4820     | 20.0               | 9.0               | 12.0              |              |                                      |                         |  |   |                  |                    | 350          | £246.87          |
| 6.4                     | OJSSDS6414     | 14.0               | 3.5               | 6.0               | 6.5          | 12.7                                 | 2.1                     | 3.90                                       | 32.0                                    | 6800             | 8700               | 250          | £412.97          |
|                         | OJSSDS6415     | 15.0               | 4.5               | 8.0               |              |                                      |                         |  |   |                  |                    | 250          | £414.36          |
|                         | OJSSDS6420     | 20.0               | 8.0               | 12.0              |              |                                      |                         |  |   |                  |                    | 250          | £440.93          |

Grip range and test data are guide figures only

# DOME HEAD GROOVED BLIND RIVET

● **BODY:** Aluminium (AlMg3.5)

● **MANDREL:** Steel Zinc&Clr Tri3

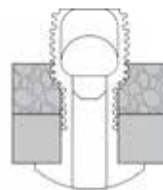
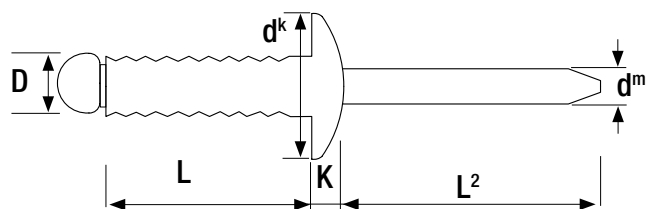

| Nominal Diameter mm (D) | Article Number | Body Length mm (L) | Grip Range Min mm | Grip Range Max mm | Hole Size mm | Flange Diameter mm (d <sup>k</sup> ) | Flange Thickness mm (K) | Nom. Mandrel Diameter mm (d <sup>m</sup> ) | Min Mandrel Length mm (L <sup>2</sup> ) | Shear Strength N | Tensile Strength N | Box Quantity | Price £ Per 1000 |
|-------------------------|----------------|--------------------|-------------------|-------------------|--------------|--------------------------------------|-------------------------|--|---|------------------|--------------------|--------------|------------------|
| 3.2                     | OJASDG3210     | 10.0               | Max =             | 6.0               | 3.4          | 6.0                                  | 1.4                     | 1.80                                       | 26.0                                    | 525              | 930                | 1000         | £25.45           |
|                         | OJASDG3214     | 14.0               | Max =             | 10.0              |              |                                      |                         |  |   |                  |                    | 1000         | £26.90           |
| 4.0                     | OJASDG4008     | 8.0                | Max =             | 4.0               | 4.3          | 8.0                                  | 1.7                     | 2.20                                       | 27.0                                    | 885              | 1410               | 800          | £30.33           |
|                         | OJASDG4010     | 10.0               | Max =             | 6.0               |              |                                      |                         |  |   |                  |                    | 800          | £31.66           |
|                         | OJASDG4012     | 12.0               | Max =             | 8.0               |              |                                      |                         |  |   |                  |                    | 800          | £33.71           |
|                         | OJASDG4014     | 14.0               | Max =             | 10.0              |              |                                      |                         |  |   |                  |                    | 500          | £36.69           |
|                         | OJASDG4016     | 16.0               | Max =             | 12.0              |              |                                      |                         |  |   |                  |                    | 500          | £38.20           |
| 4.8                     | OJASDG4808     | 8.0                | Max =             | 4.0               | 5.1          | 9.5                                  | 2.0                     | 2.65                                       | 28.0                                    | 1185             | 1575               | 500          | £41.69           |
|                         | OJASDG4810     | 10.0               | Max =             | 6.0               |              |                                      |                         |  |   |                  |                    | 500          | £44.11           |
|                         | OJASDG4811     | 11.0               | Max =             | 7.0               |              |                                      |                         |  |   |                  |                    | 500          | £44.96           |
|                         | OJASDG4812     | 12.0               | Max =             | 8.0               |              |                                      |                         |  |   |                  |                    | 500          | £45.45           |
|                         | OJASDG4814     | 14.0               | Max =             | 10.0              |              |                                      |                         |  |   |                  |                    | 500          | £51.34           |
|                         | OJASDG4816     | 16.0               | Max =             | 12.0              |              |                                      |                         |  |   |                  |                    | 400          | £52.40           |
|                         | OJASDG4818     | 18.0               | Max =             | 14.0              |              |                                      |                         |  |   |                  |                    | 400          | £54.57           |
|                         | OJASDG4820     | 20.0               | Max =             | 16.0              |              |                                      |                         |  |   |                  |                    | 350          | £59.02           |
|                         | OJASDG4825     | 25.0               | Max =             | 21.0              |              |                                      |                         |  |   |                  |                    | 250          | £65.15           |

# DOME HEAD PEEL BLIND RIVET

- **BODY:** Aluminium (AlMg5)
- **MANDREL:** Steel Zinc&Clr Tri3

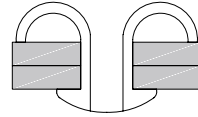
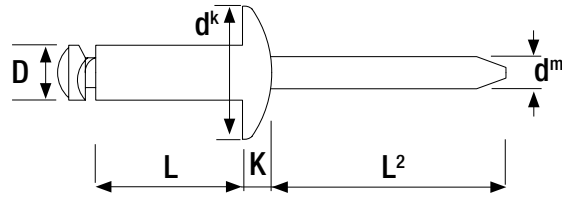

| Nominal Diameter mm (D) | Article Number | Body Length mm (L) | Grip Range Min mm | Grip Range Max mm | Hole Size mm | Flange Diameter mm (d <sup>k</sup> ) | Flange Thickness mm (K) | Nom. Mandrel Diameter mm (d <sup>m</sup> ) | Min Mandrel Length mm (L <sup>2</sup> ) | Shear Strength N | Tensile Strength N | Box Quantity | Price £ Per 1000 |
|-------------------------|----------------|--------------------|-------------------|-------------------|--------------|--------------------------------------|-------------------------|--|---|------------------|--------------------|--------------|------------------|
| <b>3.2</b>              | OJASDP3208     | 8.0                | 0.5               | 1.0               | 3.5-3.7      | 6.0                                  | 0.8                     | 1.90                                       | 26.0                                    | 765              | 700                | 1000         | £23.14           |
|                         | OJASDP3210     | 10.0               | 1.0               | 3.0               |              |                                      |                         |  |   |                  |                    | 1000         | £25.63           |
|                         | OJASDP3212     | 12.0               | 3.0               | 5.0               |              |                                      |                         |  |   |                  |                    | 1000         | £25.68           |
|                         | OJASDP3216     | 16.0               | 7.0               | 9.0               |              |                                      |                         |  |   |                  |                    | 800          | £34.69           |
| <b>4.0</b>              | OJASDP4010     | 10.0               | 1.5               | 4.5               | 4.3-4.5      | 8.0                                  | 1.2                     | 2.30                                       | 27.0                                    | 1260             | 1150               | 800          | £30.63           |
|                         | OJASDP4012     | 12.0               | 4.0               | 6.5               |              |                                      |                         |  |   |                  |                    | 800          | £32.76           |
|                         | OJASDP4014     | 14.0               | 5.0               | 8.5               |              |                                      |                         |  |   |                  |                    | 500          | £35.72           |
|                         | OJASDP4016     | 16.0               | 8.0               | 10.5              |              |                                      |                         |  |   |                  |                    | 500          | £37.29           |
|                         | OJASDP4018     | 18.0               | 10.0              | 12.5              |              |                                      |                         |  |   |                  |                    | 500          | £38.61           |
|                         | OJASDP4020     | 20.0               | 12.0              | 14.5              |              |                                      |                         |  |   |                  |                    | 500          | £45.74           |
| <b>4.8</b>              | OJASDP4810     | 10.0               | 0.5               | 4.0               | 5.1-5.3      | 9.5                                  | 1.3                     | 2.60                                       | 28.0                                    | 2400             | 2200               | 500          | £43.82           |
|                         | OJASDP4812     | 12.0               | 2.0               | 6.0               |              |                                      |                         |  |   |                  |                    | 500          | £45.14           |
|                         | OJASDP4814     | 14.0               | 4.0               | 8.0               |              |                                      |                         |  |   |                  |                    | 500          | £48.82           |
|                         | OJASDP4816     | 16.0               | 6.0               | 9.5               |              |                                      |                         |  |   |                  |                    | 400          | £52.33           |
|                         | OJASDP4818     | 18.0               | 8.0               | 11.0              |              |                                      |                         |  |   |                  |                    | 400          | £54.52           |
|                         | OJASDP4820     | 20.0               | 10.0              | 14.0              |              |                                      |                         |  |   |                  |                    | 350          | £61.77           |
|                         | OJASDP4822     | 22.0               | 12.0              | 16.0              |              |                                      |                         |  |   |                  |                    | 300          | £67.32           |
|                         | OJASDP4825     | 25.0               | 16.0              | 19.0              |              |                                      |                         |  |   |                  |                    | 250          | £71.32           |
|                         | OJASDP4830     | 30.0               | 19.0              | 24.0              |              |                                      |                         |  |   |                  |                    | 250          | £78.14           |
|                         | OJASDP4835     | 35.0               | 24.0              | 28.0              |              |                                      |                         |  |   |                  |                    | 200          | £102.62          |

Grip range and test data are guide figures only

# DOME HEAD LOAD SPREAD BLIND RIVET

- **BODY:** Aluminium (AlMg3.5)
- **MANDREL:** Aluminium (AlMg5)

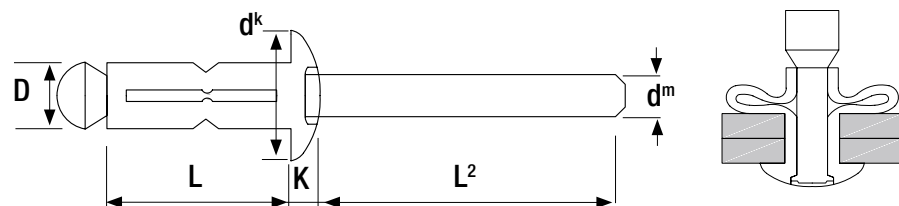

| Nominal Diameter mm (D) | Article Number | Body Length mm (L) | Grip Range Min mm | Grip Range Max mm | Hole Size mm | Flange Diameter mm (d <sup>k</sup> ) | Flange Thickness mm (K) | Nom. Mandrel Diameter mm (d <sup>m</sup> ) | Min Mandrel Length mm (L <sup>2</sup> ) | Shear Strength N | Tensile Strength N | Box Quantity | Price £ Per 1000 |
|-------------------------|----------------|--------------------|-------------------|-------------------|--------------|--------------------------------------|-------------------------|--|---|------------------|--------------------|--------------|------------------|
| 4.0                     | OJADLS4013     | 13.6               | 1.0               | 3.0               | 4.2-4.4      | 8.0                                  | 1.7                     | 2.50                                       | 27.0                                    | 500              | 800                | 500          | £93.57           |
|                         | OJADLS4018     | 18.8               | 1.0               | 7.0               |              |                                      |                         |  |   |                  |                    | 500          | £104.74          |
|                         | OJADLS4021     | 21.0               | 1.0               | 8.5               |              |                                      |                         |  |   |                  |                    | 500          | £106.63          |
| 4.8                     | OJADLS4815     | 15.3               | 1.0               | 4.0               | 5.0-5.2      | 9.6                                  | 2.0                     | 2.90                                       | 28.0                                    | 800              | 1100               | 500          | £113.94          |
|                         | OJADLS4820     | 20.5               | 1.0               | 8.5               |              |                                      |                         |  |   |                  |                    | 350          | £126.07          |
|                         | OJADLS4824     | 24.5               | 4.0               | 12.5              |              |                                      |                         |  |   |                  |                    | 250          | £142.19          |



# DOME HEAD LOAD SPREAD WITH WASHER BLIND RIVET

- **BODY:** Aluminium (AlMg5)
- **MANDREL:** Aluminium 7075 (Grooved)

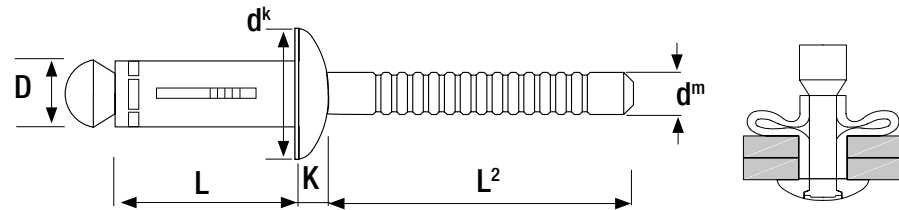

| Nominal Diameter mm (D) | Article Number | Body Length mm (L) | Grip Range Min mm | Grip Range Max mm | Hole Size mm | Flange Diameter mm (d <sup>k</sup> ) | Flange Thickness mm (K) | Nom. Mandrel Diameter mm (d <sup>m</sup> ) | Min Mandrel Length mm (L <sup>2</sup> ) | Shear Strength N | Tensile Strength N | Box Quantity | Price £ Per 1000 |
|-------------------------|----------------|--------------------|-------------------|-------------------|--------------|--------------------------------------|-------------------------|--|---|------------------|--------------------|--------------|------------------|
| 5.2                     | OJADLS5217W    | 17.5               | 0.5               | 4.8               | 5.3-5.5      | 11.7                                 | 2.2                     | 2.90                                       | 28.0                                    | 2700             | 1950               | 300          | £309.92          |
|                         | OJADLS5219W    | 19.1               | 1.5               | 6.4               |              |                                      |                         |  |   |                  |                    | 300          | £333.11          |
|                         | OJADLS5222W    | 22.2               | 4.8               | 9.5               |              |                                      |                         |  |   |                  |                    | 300          | £371.93          |
|                         | OJADLS5225W    | 25.4               | 7.9               | 12.7              |              |                                      |                         |  |   |                  |                    | 300          | £402.57          |
|                         | OJADLS5228W    | 28.6               | 11.1              | 15.9              |              |                                      |                         |  |   |                  |                    | 250          | £510.90          |
|                         | OJADLS5231W    | 31.8               | 14.3              | 19.1              |              |                                      |                         |  |   |                  |                    | 250          | £574.38          |
| 6.4                     | OJADLS6420W    | 20.5               | 1.6               | 6.4               | 6.4-6.6      | 14.7                                 | 4.0                     | 3.90                                       | 25.4                                    | 4900             | 2800               | 200          | £464.30          |
|                         | OJADLS6423W    | 23.7               | 3.2               | 9.5               |              |                                      |                         |  |   |                  |                    | 100          | £488.58          |
|                         | OJADLS6426W    | 26.8               | 6.4               | 12.7              |              |                                      |                         |  |   |                  |                    | 100          | £512.87          |
|                         | OJADLS6430W    | 30.0               | 9.5               | 15.9              |              |                                      |                         |  |   |                  |                    | 100          | £537.22          |
| 7.8                     | OJADLS7828W    | 28.2               | 0.8               | 9.5               | 7.8-8.2      | 15.9                                 | 4.8                     | 4.50                                       | 25.4                                    | 6650             | 4895               | 100          | £1,011.72        |
|                         | OJADLS7834W    | 34.5               | 6.4               | 15.9              |              |                                      |                         |  |   |                  |                    | 100          | £1,097.94        |
|                         | OJADLS7837W    | 37.7               | 9.5               | 19.1              |              |                                      |                         |  |   |                  |                    | 100          | £1,254.78        |

Grip range and test data are guide figures only



# LARGE FLANGE HEAD LOAD SPREAD WITH WASHER BLIND RIVET

- **BODY:** Aluminium (AlMg5)
- **MANDREL:** Aluminium 7075 (Grooved)

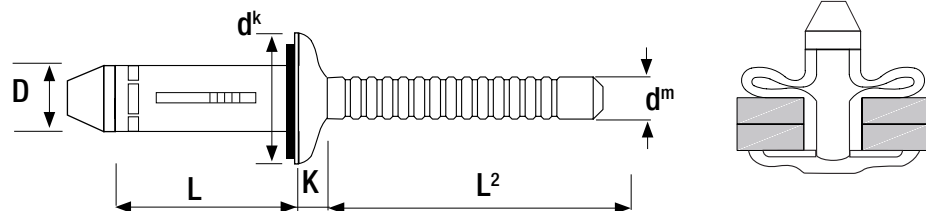
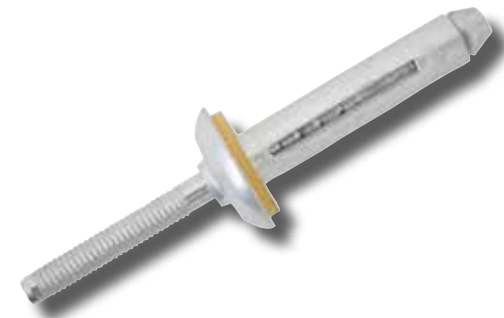

| Nominal Diameter mm (D) | Article Number | Body Length mm (L) | Grip Range Min mm | Grip Range Max mm | Hole Size mm | Flange Diameter mm (d <sup>k</sup> ) | Flange Thickness mm (K) | Nom. Mandrel Diameter mm (d <sup>m</sup> ) | Min Mandrel Length mm (L <sup>2</sup> ) | Shear Strength N | Tensile Strength N | Box Quantity | Price £ Per 1000 |
|-------------------------|----------------|--------------------|-------------------|-------------------|--------------|--------------------------------------|-------------------------|--|---|------------------|--------------------|--------------|------------------|
| 7.8                     | OJADLLS7828W   | 28.2               | 0.8               | 9.5               | 7.8-8.2      | 19.4                                 | 5.3                     | 4.50                                       | 25.4                                    | 6650             | 4895               | 100          | £1,011.73        |
|                         | OJADLLS7834W   | 34.5               | 6.4               | 15.9              |              |                                      |                         |  |   |                  |                    | 100          | £1,097.95        |
|                         | OJADLLS7837W   | 37.7               | 9.5               | 19.1              |              |                                      |                         |  |   |                  |                    | 50           | £1,254.78        |

# DOME HEAD JRP-LOCK STRUCTURAL BLIND RIVET

- **BODY:** Aluminium 5056
- **MANDREL:** Aluminium 7075 (Grooved)

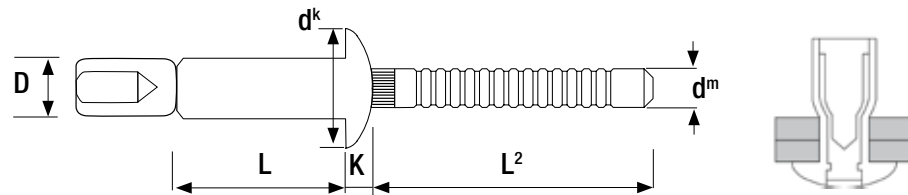

| Nominal Diameter mm (D) | Article Number | Body Length mm (L) | Grip Range Min mm | Grip Range Max mm | Hole Size mm | Flange Diameter mm (d <sup>k</sup> ) | Flange Thickness mm (K) | Nom. Mandrel Diameter mm (d <sup>m</sup> ) | Min Mandrel Length mm (L <sup>2</sup> ) | Shear Strength N | Tensile Strength N | Mandrel Retention Strength N | Box Quantity | Price £ Per 1000 |
|-------------------------|----------------|--------------------|-------------------|-------------------|--------------|--------------------------------------|-------------------------|--|---|------------------|--------------------|------------------------------|--------------|------------------|
| 4.8                     | OJADH4810      | 10.0               | 1.8               | 6.9               | 4.9-5.1      | 10.0                                 | 2.2                     | 3.00                                       | 26.0                                    | 2400             | 2000               | 222                          | 250          | £232.20          |
|                         | OJADH4814      | 14.5               | 1.8               | 11.0              |              |                                      |                         |  |   |                  |                    |                              | 250          | £252.34          |
| 6.4                     | OJADH6414      | 14.5               | 2.0               | 9.5               | 6.6-6.9      | 13.5                                 | 3.0                     | 4.00                                       | 26.0                                    | 5400             | 3600               | 445                          | 200          | £336.01          |
|                         | OJADH6420      | 20.5               | 2.0               | 15.9              |              |                                      |                         |  |   |                  |                    |                              | 150          | £380.49          |

Grip range and test data are guide figures only

# COUNTERSUNK HEAD JRP-LOCK STRUCTURAL BLIND RIVET

- **BODY:** Aluminium 5056
- **MANDREL:** Aluminium 7075 (Grooved)

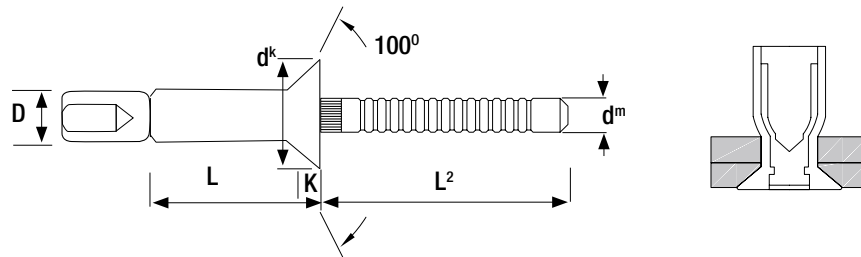

| Nominal Diameter mm (D) | Article Number | Body Length mm (L) | Grip Range Min mm | Grip Range Max mm | Hole Size mm | Flange Diameter mm (d <sup>k</sup> ) | Flange Thickness mm (K) | Nom. Mandrel Diameter mm (d <sup>m</sup> ) | Min Mandrel Length mm (L <sup>2</sup> ) | Shear Strength N | Tensile Strength N | Mandrel Retention Strength N | Box Quantity | Price £ Per 1000 |
|-------------------------|----------------|--------------------|-------------------|-------------------|--------------|--------------------------------------|-------------------------|--|---|------------------|--------------------|------------------------------|--------------|------------------|
| <b>4.8</b>              | OJAKH4813      | 13.0               | 3.2               | 8.4               | 4.9-5.1      | 9.0                                  | 2.2                     | 3.00                                       | 26.0                                    | 2400             | 2000               | 222                          | 250          | <b>£242.10</b>   |
|                         | OJAKH4817      | 17.0               | 7.7               | 12.7              |              |                                      |                         |  |   |                  |                    |                              | 250          | <b>£264.77</b>   |
| <b>6.4</b>              | OJAKH6417      | 17.0               | 4.3               | 12.1              | 6.6-6.9      | 10.5                                 | 2.4                     | 4.00                                       | 26.0                                    | 5400             | 3600               | 445                          | 200          | <b>£355.74</b>   |

# DOME HEAD JRP-HEM STRUCTURAL BLIND RIVET

- **BODY:** Aluminium 5056
- **MANDREL:** Aluminium 7075 (Grooved)

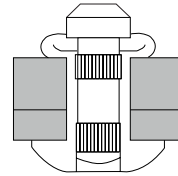
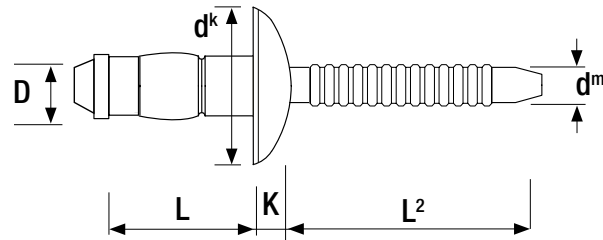

| Nominal Diameter mm (D) | Article Number | Body Length mm (L) | Grip Range Min mm | Grip Range Max mm | Hole Size mm | Flange Diameter mm (d <sup>k</sup> ) | Flange Thickness mm (K) | Nom. Mandrel Diameter mm (d <sup>m</sup> ) | Min Mandrel Length mm (L <sup>2</sup> ) | Shear Strength N | Tensile Strength N | Box Quantity | Price £ Per 1000 |
|-------------------------|----------------|--------------------|-------------------|-------------------|--------------|--------------------------------------|-------------------------|--|---|------------------|--------------------|--------------|------------------|
| <b>4.8</b>              | OJADHE4809     | 9.0                | 1.5               | 3.5               | 4.9-5.1      | 10.0                                 | 2.5                     | 3.40                                       | 28.0                                    | 2500             | 1600               | 250          | £180.41          |
|                         | OJADHE4811     | 11.5               | 3.5               | 6.0               |              |                                      |                         |  |   |                  |                    | 250          | £199.98          |
|                         | OJADHE4814     | 14.0               | 6.0               | 8.5               |              |                                      |                         |  |   |                  |                    | 250          | £219.56          |
|                         | OJADHE4816     | 16.5               | 8.5               | 11.0              |              |                                      |                         |  |   |                  |                    | 250          | £235.24          |
|                         | OJADHE4819     | 19.0               | 11.0              | 13.5              |              |                                      |                         |  |   |                  |                    | 250          | £254.89          |
| <b>6.4</b>              | OJADHE6410     | 10.5               | 2.5               | 4.5               | 6.6-6.8      | 13.4                                 | 3.5                     | 4.20                                       | 30.0                                    | 4200             | 3400               | 250          | £266.64          |
|                         | OJADHE6412     | 12.5               | 4.0               | 6.5               |              |                                      |                         |  |   | 4500             |                    | 250          | £282.33          |
|                         | OJADHE6414     | 14.5               | 6.0               | 8.5               |              |                                      |                         |  |   | 4900             |                    | 250          | £290.16          |
|                         | OJADHE6416     | 16.5               | 7.5               | 10.5              |              |                                      |                         |  |   | 250              |                    | £297.97      |                  |
|                         | OJADHE6418     | 18.5               | 9.5               | 12.5              |              |                                      |                         |  |   | 250              |                    | £305.87      |                  |
|                         | OJADHE6420     | 20.5               | 11.0              | 14.0              |              |                                      |                         |  |   | 200              |                    | £313.73      |                  |
|                         | OJADHE6422     | 22.5               | 13.0              | 16.0              |              |                                      |                         |  |   | 200              |                    | £329.41      |                  |
|                         | OJADHE6424     | 24.5               | 15.0              | 18.0              |              |                                      |                         |  |   | 200              |                    | £345.06      |                  |
|                         | OJADHE6426     | 26.5               | 17.0              | 20.0              |              |                                      |                         |  |   | 150              |                    | £364.08      |                  |

Grip range and test data are guide figures only

# DOME HEAD JRP-LOCK STRUCTURAL BLIND RIVET

- BODY:** Steel Zinc&Clr Tri3
- MANDREL:** Steel Zinc&Clr Tri3 (Grooved)

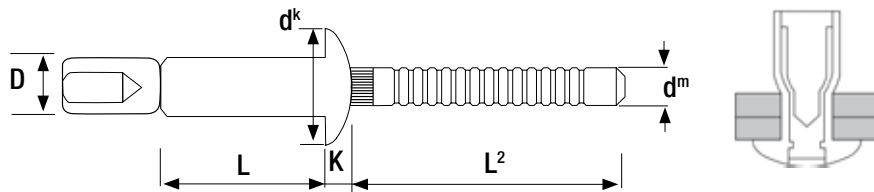

| Nominal Diameter mm (D) | Article Number | Body Length mm (L) | Grip Range Min mm | Grip Range Max mm | Hole Size mm | Flange Diameter mm (d <sup>k</sup> ) | Flange Thickness mm (K) | Nom. Mandrel Diameter mm (d <sup>m</sup> ) | Min Mandrel Length mm (L <sup>2</sup> ) | Shear Strength N | Tensile Strength N | Mandrel Retention Strength N | Box Quantity | Price £ Per 1000 |
|-------------------------|----------------|--------------------|-------------------|-------------------|--------------|--------------------------------------|-------------------------|--|---|------------------|--------------------|------------------------------|--------------|------------------|
| <b>4.8</b>              | OJSDH4810      | 10.5               | 1.8               | 6.9               | 4.9-5.1      | 10.0                                 | 2.2                     | 3.00                                       | 26.0                                    | 5700             | 4400               | 445                          | 250          | <b>£164.53</b>   |
|                         | OJSDH4814      | 14.5               | 1.8               | 11.0              |              |                                      |                         |  |   |                  |                    |                              | 250          | <b>£180.19</b>   |
| <b>6.4</b>              | OJSDH6414      | 14.5               | 2.0               | 9.5               | 6.6-6.9      | 13.5                                 | 3.0                     | 4.00                                       | 40.0                                    | 10500            | 8200               | 1112                         | 200          | <b>£238.96</b>   |
|                         | OJSDH6420      | 20.5               | 2.0               | 15.9              |              |                                      |                         |  |   |                  |                    |                              | 150          | <b>£286.05</b>   |
| <b>9.8</b>              | OJSDH9821      | 21.3               | 3.1               | 14.2              | 10.0-10.4    | 20.0                                 | 4.5                     | 5.80                                       | 40.0                                    | 26690            | 17790              | 2670                         | 50           | <b>£1,018.71</b> |

Also available in retail bags. See page 82.



# COUNTERSUNK HEAD JRP-LOCK STRUCTURAL BLIND RIVET

- BODY:** Steel Zinc&Clr Tri3
- MANDREL:** Steel Zinc&Clr Tri3 (Grooved)

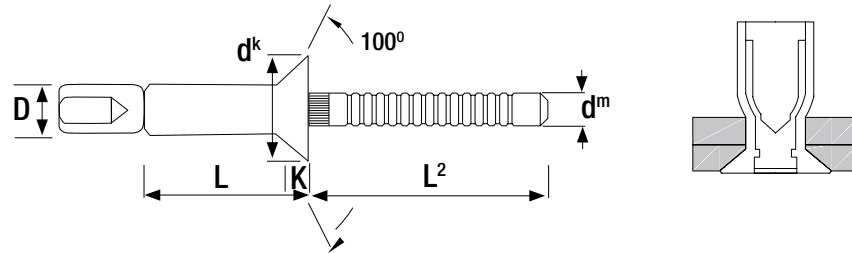

| Nominal Diameter mm (D) | Article Number | Body Length mm (L) | Grip Range Min mm | Grip Range Max mm | Hole Size mm | Flange Diameter mm (d <sup>k</sup> ) | Flange Thickness mm (K) | Nom. Mandrel Diameter mm (d <sup>m</sup> ) | Min Mandrel Length mm (L <sup>2</sup> ) | Shear Strength N | Tensile Strength N | Mandrel Retention Strength N | Box Quantity | Price £ Per 1000 |
|-------------------------|----------------|--------------------|-------------------|-------------------|--------------|--------------------------------------|-------------------------|--|---|------------------|--------------------|------------------------------|--------------|------------------|
| 4.8                     | OJSKH4812      | 12.0               | 3.2               | 8.4               | 4.9-5.1      | 9.0                                  | 2.2                     | 3.00                                       | 26.0                                    | 5700             | 4400               | 445                          | 250          | £172.37          |
|                         | OJSKH4816      | 16.0               | 7.7               | 12.7              |              |                                      |                         |  |   |                  |                    |                              | 250          | £188.02          |
| 6.4                     | OJSKH6416      | 16.0               | 4.3               | 12.1              | 6.6-6.9      | 10.5                                 | 2.4                     | 4.00                                       | 26.0                                    | 10500            | 8200               | 1112                         | 200          | £250.76          |
|                         | OJSKH6422      | 22.0               | 10.5              | 17.0              |              |                                      |                         |  |   |                  |                    |                              | 150          | £297.74          |

Grip range and test data are guide figures only

# DOME HEAD JRP-BULB STRUCTURAL BLIND RIVET

- BODY:** Steel Zinc&Clr Tri3
- MANDREL:** Steel Zinc&Clr Tri3 (Grooved)

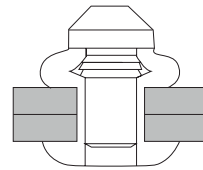
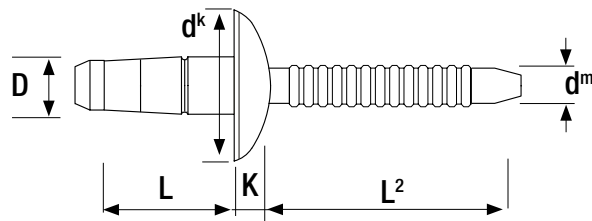
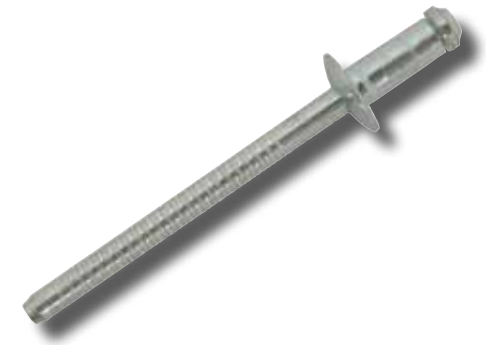

| Nominal Diameter mm (D) | Article Number | Body Length mm (L) | Grip Range Min mm | Grip Range Max mm | Hole Size mm | Flange Diameter mm (d <sup>k</sup> ) | Flange Thickness mm (K) | Nom. Mandrel Diameter mm (d <sup>m</sup> ) | Min Mandrel Length mm (L <sup>2</sup> ) | Shear Strength N | Tensile Strength N | Box Quantity | Price £ Per 1000 |
|-------------------------|----------------|--------------------|-------------------|-------------------|--------------|--------------------------------------|-------------------------|--|---|------------------|--------------------|--------------|------------------|
| 3.2                     | OJSDBU3206     | 6.5                | 1.0               | 3.0               | 3.3-3.4      | 6.8                                  | 1.4                     | 2.00                                       | 26.0                                    | 1200             | 1300               | 1000         | £45.26           |
|                         | OJSDBU3210     | 9.5                | 5.0               | 7.0               |              |                                      |                         |  |   | 1700             |                    | 1000         | £46.10           |
|                         | OJSDBU3211     | 11.5               | 5.0               | 7.0               |              |                                      |                         |  |   | 2500             |                    | 1000         | £55.35           |
| 4.0                     | OJSDBU4007     | 7.5                | 1.0               | 3.0               | 4.1-4.3      | 8.0                                  | 1.4                     | 2.60                                       | 27.0                                    | 2400             | 2800               | 500          | £53.65           |
|                         | OJSDBU4010     | 10.0               | 3.0               | 5.0               |              |                                      |                         |  |   | 3500             |                    | 500          | £55.35           |
|                         | OJSDBU4012     | 12.5               | 5.0               | 7.0               |              |                                      |                         |  |   | 4100             |                    | 500          | £66.26           |
| 4.8                     | OJSDBU4810     | 10.0               | 1.5               | 3.5               | 4.9-5.1      | 9.6                                  | 1.5                     | 3.20                                       | 27.0                                    | 3600             | 3800               | 500          | £79.91           |
|                         | OJSDBU4812     | 12.0               | 3.5               | 6.0               |              |                                      |                         |  |   | 4200             |                    | 500          | £75.46           |
|                         | OJSDBU4814     | 14.0               | 6.0               | 8.5               |              |                                      |                         |  |   | 5600             |                    | 500          | £78.80           |
|                         | OJSDBU4816     | 16.5               | 7.5               | 10.0              |              |                                      |                         |  |   |                  |                    | 400          | £88.05           |

# DOME HEAD JRP-HEM STRUCTURAL BLIND RIVET

- BODY:** Steel Zinc&Clr Tri3
- MANDREL:** Steel Zinc&Clr Tri3 (Grooved)

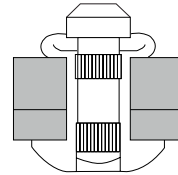
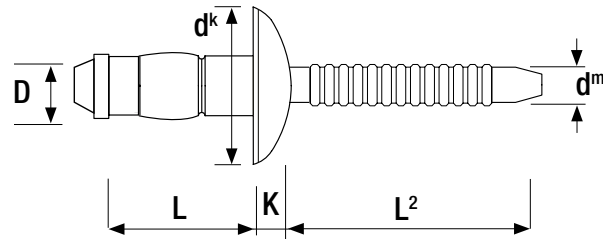

| Nominal Diameter mm (D) | Article Number | Body Length mm (L) | Grip Range Min mm | Grip Range Max mm | Hole Size mm | Flange Diameter mm (d <sup>k</sup> ) | Flange Thickness mm (K) | Nom. Mandrel Diameter mm (d <sup>m</sup> ) | Min Mandrel Length mm (L <sup>2</sup> ) | Shear Strength N | Tensile Strength N | Box Quantity | Price £ Per 1000 |
|-------------------------|----------------|--------------------|-------------------|-------------------|--------------|--------------------------------------|-------------------------|--|---|------------------|--------------------|--------------|------------------|
| 4.8                     | OJSDHE4809     | 9.0                | 1.5               | 3.5               | 4.9-5.1      | 10.0                                 | 2.5                     | 3.40                                       | 28.0                                    | 4500             | 3500               | 250          | £136.28          |
|                         | OJSDHE4811     | 11.5               | 3.5               | 6.0               |              |                                      |                         |  |   | 6000             |                    | 250          | £150.20          |
|                         | OJSDHE4814     | 14.0               | 6.0               | 8.5               |              |                                      |                         |  |   | 6200             |                    | 250          | £164.20          |
|                         | OJSDHE4816     | 16.5               | 8.5               | 11.0              |              |                                      |                         |  |   | 250              |                    | £178.17      |                  |
|                         | OJSDHE4819     | 19.0               | 11.0              | 13.5              |              |                                      |                         |  |   | 250              |                    | £192.17      |                  |
| 6.4                     | OJSDHE6409     | 9.0                | 1.5               | 3.5               | 6.6-6.8      | 13.4                                 | 3.5                     | 4.20                                       | 30.0                                    | 6800             | 6400               | 250          | £195.62          |
|                         | OJSDHE6410     | 10.5               | 2.0               | 4.5               |              |                                      |                         |  |   | 9200             |                    | 250          | £219.35          |
|                         | OJSDHE6412     | 12.5               | 3.5               | 6.5               |              |                                      |                         |  |   | 10000            |                    | 250          | £230.67          |
|                         | OJSDHE6414     | 14.5               | 5.5               | 8.5               |              |                                      |                         |  |   |                  |                    | 250          | £234.49          |
|                         | OJSDHE6416     | 16.5               | 7.5               | 10.5              |              |                                      |                         |  |   | 11000            |                    | 250          | £249.62          |
|                         | OJSDHE6418     | 18.5               | 9.5               | 12.5              |              |                                      |                         |  |   |                  |                    | 250          | £237.56          |
|                         | OJSDHE6420     | 20.5               | 11.0              | 14.0              |              |                                      |                         |  |   |                  |                    | 200          | £268.56          |
|                         | OJSDHE6422     | 22.5               | 13.0              | 16.0              |              |                                      |                         |  |   | 200              |                    | £255.06      |                  |
|                         | OJSDHE6424     | 24.5               | 14.5              | 18.0              |              |                                      |                         |  |   | 200              |                    | £283.74      |                  |
|                         | OJSDHE6426     | 26.5               | 16.5              | 20.0              |              |                                      |                         |  |   | 150              |                    | £294.99      |                  |
|                         | OJSDHE6428     | 28.5               | 18.5              | 22.0              |              |                                      |                         |  |   | 150              |                    | £282.98      |                  |
|                         | OJSDHE6430     | 30.5               | 20.5              | 24.0              |              |                                      |                         |  |   | 150              |                    | £293.49      |                  |
|                         | OJSDHE6432     | 32.5               | 22.5              | 26.0              |              |                                      |                         |  |   | 100              |                    | £338.40      |                  |

Grip range and test data are guide figures only

# DOME HEAD JRP-LOCK STRUCTURAL BLIND RIVET

- BODY:** A2 Stainless Steel (AISI302)
- MANDREL:** A2 Stainless Steel (AISI304) (Grooved)

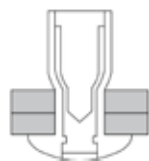
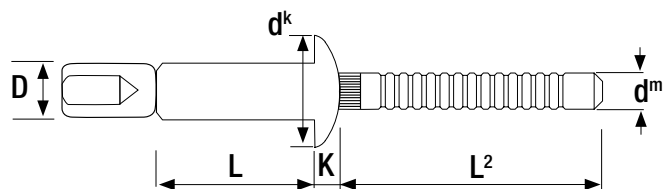

| Nominal Diameter mm (D) | Article Number | Body Length mm (L) | Grip Range Min mm | Grip Range Max mm | Hole Size mm | Flange Diameter mm (d <sup>k</sup> ) | Flange Thickness mm (K) | Nom. Mandrel Diameter mm (d <sup>m</sup> ) | Min Mandrel Length mm (L <sup>2</sup> ) | Shear Strength N | Tensile Strength N | Mandrel Retention Strength N | Box Quantity | Price £ Per 1000 |
|-------------------------|----------------|--------------------|-------------------|-------------------|--------------|--------------------------------------|-------------------------|--|---|------------------|--------------------|------------------------------|--------------|------------------|
| 4.8                     | OJSSDH4810     | 10.5               | 1.8               | 6.9               | 4.9-5.1      | 10.0                                 | 2.2                     | 3.00                                       | 26.0                                    | 5700             | 4400               | 445                          | 250          | £394.31          |
|                         | OJSSDH4814     | 14.5               | 1.8               | 11.0              |              |                                      |                         |  |   |                  |                    |                              | 250          | £423.87          |
| 6.4                     | OJSSDH6414     | 14.5               | 2.0               | 9.5               | 6.6-6.9      | 13.5                                 | 3.0                     | 4.00                                       | 26.0                                    | 10500            | 8200               | 1112                         | 200          | £690.06          |
|                         | OJSSDH6420     | 20.5               | 2.0               | 15.9              |              |                                      |                         |  |   |                  |                    |                              | 150          | £818.32          |

Also available in retail bags. See page 84.

# COUNTERSUNK HEAD JRP-LOCK STRUCTURAL BLIND RIVET

- BODY:** A2 Stainless Steel (AISI302)
- MANDREL:** A2 Stainless Steel (AISI304) (Grooved)

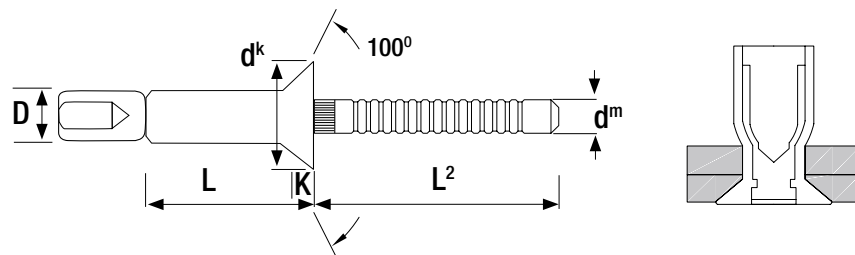

| Nominal Diameter mm (D) | Article Number | Body Length mm (L) | Grip Range Min mm | Grip Range Max mm | Hole Size mm | Flange Diameter mm (d <sup>k</sup> ) | Flange Thickness mm (K) | Nom. Mandrel Diameter mm (d <sup>m</sup> ) | Min Mandrel Length mm (L <sup>2</sup> ) | Shear Strength N | Tensile Strength N | Mandrel Retention Strength N | Box Quantity | Price £ Per 1000 |
|-------------------------|----------------|--------------------|-------------------|-------------------|--------------|--------------------------------------|-------------------------|--|---|------------------|--------------------|------------------------------|--------------|------------------|
| 4.8                     | OJSSKH4813     | 13.0               | 3.2               | 8.4               | 4.9-5.1      | 9.0                                  | 2.2                     | 3.00                                       | 26.0                                    | 5700             | 4400               | 445                          | 250          | £408.25          |
|                         | OJSSKH4817     | 17.0               | 7.7               | 12.7              |              |                                      |                         |  |   |                  |                    |                              | 250          | £439.00          |
| 6.4                     | OJSSKH6417     | 17.0               | 4.3               | 12.1              | 6.6-6.9      | 10.5                                 | 2.4                     | 4.00                                       | 26.0                                    | 10500            | 8200               | 1112                         | 200          | £732.04          |
|                         | OJSSKH6423     | 23.0               | 10.5              | 17.0              |              |                                      |                         |  |   |                  |                    |                              | 150          | £894.83          |

Grip range and test data are guide figures only

# DOME HEAD JRP-BULB STRUCTURAL BLIND RIVET

- BODY:** A2 Stainless Steel (AISI304)
- MANDREL:** A2 Stainless Steel (AISI304) (Grooved)

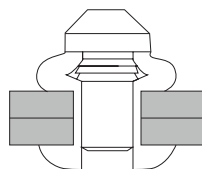
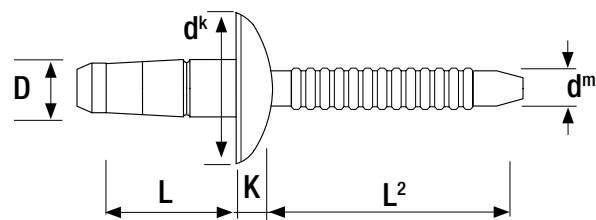

| Nominal Diameter mm (D) | Article Number | Body Length mm (L) | Grip Range Min mm | Grip Range Max mm | Hole Size mm | Flange Diameter mm (d <sup>k</sup> ) | Flange Thickness mm (K) | Nom. Mandrel Diameter mm (d <sup>m</sup> ) | Min Mandrel Length mm (L <sup>2</sup> ) | Shear Strength N | Tensile Strength N | Box Quantity | Price £ Per 1000 |
|-------------------------|----------------|--------------------|-------------------|-------------------|--------------|--------------------------------------|-------------------------|--|---|------------------|--------------------|--------------|------------------|
| 3.2                     | OJSSDBU3206    | 6.5                | 1.0               | 3.0               | 3.3-3.4      | 6.6                                  | 1.1                     | 2.10                                       | 26.0                                    | 1600             | 2000               | 1000         | £76.31           |
|                         | OJSSDBU3210    | 9.5                | 3.0               | 5.0               |              |                                      |                         |  |   | 1700             |                    | 1000         | £79.14           |
|                         | OJSSDBU3211    | 11.5               | 5.0               | 7.0               |              |                                      |                         |  |   | 3200             |                    | 1000         | £80.99           |
| 4.0                     | OJSSDBU4007    | 7.5                | 1.0               | 3.0               | 4.1-4.3      | 8.0                                  | 1.5                     | 2.60                                       | 27.0                                    | 2800             | 4000               | 500          | £98.91           |
|                         | OJSSDBU4010    | 10.0               | 3.0               | 5.0               |              |                                      |                         |  |   | 5200             |                    | 500          | £105.84          |
|                         | OJSSDBU4012    | 12.5               | 5.0               | 7.0               |              |                                      |                         |  |   | 500              |                    | £112.78      |                  |
| 4.8                     | OJSSDBU4810    | 10.0               | 1.5               | 3.5               | 4.9-5.1      | 9.6                                  | 1.5                     | 3.20                                       | 27.0                                    | 5500             | 5000               | 500          | £130.94          |
|                         | OJSSDBU4812    | 12.0               | 3.5               | 6.0               |              |                                      |                         |  |   |                  |                    | 500          | £143.43          |
|                         | OJSSDBU4814    | 14.5               | 6.0               | 8.5               |              |                                      |                         |  |   |                  |                    | 500          | £142.26          |
|                         | OJSSDBU4816    | 16.5               | 7.5               | 10.0              |              |                                      |                         |  |   |                  |                    | 400          | £155.42          |



# DOME HEAD JRP-HEM STRUCTURAL BLIND RIVET

- BODY:** A2 Stainless Steel (AISI304)
- MANDREL:** A2 Stainless Steel (AISI304) (Grooved)

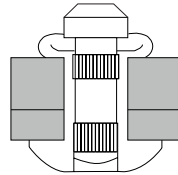
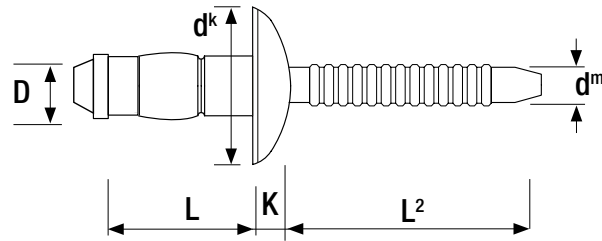

| Nominal Diameter mm (D) | Article Number | Body Length mm (L) | Grip Range Min mm | Grip Range Max mm | Hole Size mm | Flange Diameter mm (d <sup>k</sup> ) | Flange Thickness mm (K) | Nom. Mandrel Diameter mm (d <sup>m</sup> ) | Min Mandrel Length mm (L <sup>2</sup> ) | Shear Strength N | Tensile Strength N | Box Quantity | Price £ Per 1000 |
|-------------------------|----------------|--------------------|-------------------|-------------------|--------------|--------------------------------------|-------------------------|--|---|------------------|--------------------|--------------|------------------|
| 4.8                     | OJSSDHE4809    | 9.0                | 1.5               | 3.5               | 4.9-5.1      | 10.2                                 | 2.5                     | 4.20                                       | 28.0                                    | 6000             | 4900               | 250          | £431.71          |
|                         | OJSSDHE4811    | 11.5               | 3.5               | 6.0               |              |                                      |                         |  |   | 250              |                    | £447.43      |                  |
|                         | OJSSDHE4814    | 14.0               | 6.0               | 8.5               |              |                                      |                         |  |   | 250              |                    | £463.13      |                  |
|                         | OJSSDHE4816    | 16.5               | 8.5               | 11.0              |              |                                      |                         |  |   | 250              |                    | £478.78      |                  |
|                         | OJSSDHE4819    | 19.0               | 11.0              | 13.5              |              |                                      |                         |  |   | 250              |                    | £494.49      |                  |
| 6.4                     | OJSSDHE6410    | 10.5               | 2.0               | 4.5               | 6.6-6.8      | 13.4                                 | 3.5                     | 4.20                                       | 30.0                                    | 14000            | 8300               | 250          | £651.45          |
|                         | OJSSDHE6412    | 12.5               | 3.5               | 6.5               |              |                                      |                         |  |   | 250              |                    | £706.97      |                  |
|                         | OJSSDHE6414    | 14.5               | 5.5               | 8.5               |              |                                      |                         |  |   | 250              |                    | £745.70      |                  |
|                         | OJSSDHE6416    | 16.5               | 7.5               | 10.5              |              |                                      |                         |  |   | 250              |                    | £863.43      |                  |
|                         | OJSSDHE6418    | 18.5               | 9.5               | 12.5              |              |                                      |                         |  |   | 250              |                    | £941.90      |                  |
|                         | OJSSDHE6420    | 20.5               | 11.0              | 14.0              |              |                                      |                         |  |   | 200              |                    | £1,020.40    |                  |
|                         | OJSSDHE6422    | 22.5               | 13.0              | 16.0              |              |                                      |                         |  |   | 200              |                    | £1,098.88    |                  |
|                         | OJSSDHE6424    | 24.5               | 14.5              | 18.0              |              |                                      |                         |  |   | 200              |                    | £1,205.45    |                  |
|                         | OJSSDHE6426    | 26.5               | 16.5              | 20.0              |              |                                      |                         |  |   | 150              |                    | £1,255.85    |                  |

Grip range and test data are guide figures only

# MERCHANDISING THE JRP RANGE

Our Merchandising Representatives first assess the store area to be addressed and determine which configuration works best, ensuring that products are available and engaging at the point of sale. They will then oversee the building and positioning of the stands, along with loading them with stock. They will oversee all of the physical aspects of the project\*\* whilst minimising disruption.

We offer an easy and efficient stock-cleansing service, to help customers seamlessly change over from other brands to ours.

Our after-sales support includes representatives making regular visits to replenish stock and ensure the display remains looking its best.

- ✔ **Striking Livery**
- ✔ **Multiple Configurations To Suit Your Space And Product Offering**
- ✔ **Professional Installation With Minimal Disruption**
- ✔ **Maximise Sales Across Market Leading Brands**



Download our merchandising catalogue here



Ask your Area Sales Manager for a printed copy of our merchandising stands brochure or download a copy here.



# RETAIL BAGS

# DOME HEAD OPEN BLIND RIVET

- **BODY:** Aluminium (AlMg2.5\*/AlMg3.5)
- **MANDREL:** Steel Zinc&Clr Tri3

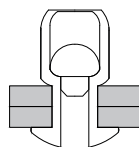
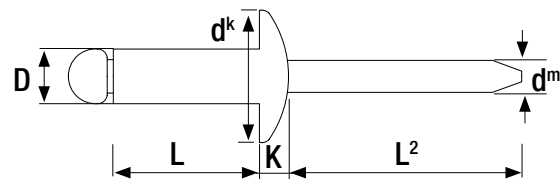

| Nominal Diameter mm (D) | Article Number | Body Length mm (L) | Grip Range Min mm | Grip Range Max mm | Hole Size mm | Flange Diameter mm (d <sup>k</sup> ) | Flange Thickness mm (K) | Nom. Mandrel Diameter mm (d <sup>m</sup> ) | Min Mandrel Length mm (L <sup>2</sup> ) | Shear Strength N | Tensile Strength N | Bag Quantity | Price £ Per Bag |
|-------------------------|----------------|--------------------|-------------------|-------------------|--------------|--------------------------------------|-------------------------|--|---|------------------|--------------------|--------------|-----------------|
| 3.2                     | JRP1000*       | 6.0                | 1.5               | 3.0               | 3.3          | 6.5                                  | 0.8                     | 1.75                                       | 26.0                                    | 760              | 980                | 100          | £3.67           |
|                         | JRP1005*       | 8.0                | 3.0               | 5.0               |              |                                      |                         |  |   |                  |                    | 100          | £3.67           |
|                         | JRP1010*       | 10.0               | 5.0               | 7.0               |              |                                      |                         |  |   |                  |                    | 100          | £3.67           |
|                         | JRP1015*       | 12.0               | 7.0               | 9.0               |              |                                      |                         |  |   |                  |                    | 100          | £3.67           |
| 4.0                     | JRP1020        | 8.0                | 2.0               | 4.0               | 4.1          | 8.0                                  | 1.0                     | 2.10                                       | 27.0                                    | 1200             | 1600               | 100          | £3.67           |
|                         | JRP1025        | 10.0               | 4.0               | 6.0               |              |                                      |                         |  |   |                  |                    | 100          | £3.67           |
|                         | JRP1030        | 12.0               | 6.0               | 8.0               |              |                                      |                         |  |   |                  |                    | 100          | £3.67           |
|                         | JRP1035        | 16.0               | 10.0              | 12.0              |              |                                      |                         |  |   |                  |                    | 50           | £3.67           |
| 4.8                     | JRP1040        | 10.0               | 3.5               | 5.5               | 4.9          | 9.5                                  | 1.1                     | 2.70                                       | 28.0                                    | 1700             | 2250               | 50           | £3.67           |
|                         | JRP1045        | 12.0               | 5.5               | 7.5               |              |                                      |                         |  |   |                  |                    | 50           | £3.67           |
|                         | JRP1050        | 16.0               | 9.0               | 11.0              |              |                                      |                         |  |   |                  |                    | 50           | £3.67           |
|                         | JRP1055        | 20.0               | 13.0              | 15.0              |              |                                      |                         |  |   |                  |                    | 25           | £3.67           |
|                         | JRP1060        | 25.0               | 17.0              | 20.0              |              |                                      |                         |  |   |                  |                    | 25           | £3.67           |
|                         | JRP1065        | 30.0               | 23.0              | 24.5              |              |                                      |                         |  |   |                  |                    | 25           | £3.67           |

Also available in boxes. See page 16.

# LARGE FLANGE HEAD OPEN BLIND RIVET

- **BODY:** Aluminium (AlMg3.5)
- **MANDREL:** Steel Zinc&Clr Tri3

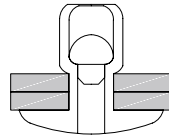
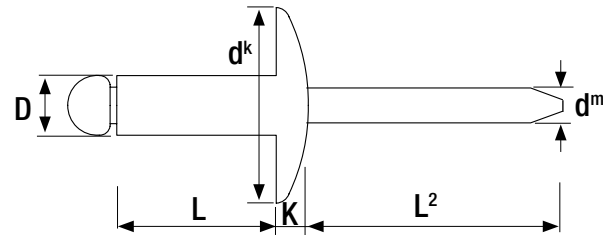

| Nominal Diameter mm (D) | Article Number | Body Length mm (L) | Grip Range Min mm | Grip Range Max mm | Hole Size mm | Flange Diameter mm (d <sup>k</sup> ) | Flange Thickness mm (K) | Nom. Mandrel Diameter mm (d <sup>m</sup> ) | Min Mandrel Length mm (L <sup>2</sup> ) | Shear Strength N | Tensile Strength N | Bag Quantity | Price £ Per Bag |
|-------------------------|----------------|--------------------|-------------------|-------------------|--------------|--------------------------------------|-------------------------|--|---|------------------|--------------------|--------------|-----------------|
| <b>4.8</b>              | JRP1140        | 10.0               | 3.5               | 5.5               | 4.9          | 14.0                                 | 2.5                     | 2.70                                       | 28.0                                    | 1540             | 2230               | 25           | £4.51           |
|                         | JRP1145        | 12.0               | 5.5               | 7.5               |              |                                      |                         |  |   |                  |                    | 25           | £4.51           |
|                         | JRP1150        | 14.0               | 7.5               | 9.5               |              |                                      |                         |  |   |                  |                    | 25           | £4.51           |
|                         | JRP1155        | 16.0               | 9.0               | 11.0              |              |                                      |                         |  |   |                  |                    | 25           | £4.51           |
|                         | JRP1160        | 20.0               | 13.0              | 15.0              |              |                                      |                         |  |   |                  |                    | 20           | £4.51           |
|                         | JRP1165        | 24.0               | 17.0              | 19.0              |              |                                      |                         |  |   |                  |                    | 20           | £4.51           |
|                         | JRP1170        | 30.0               | 23.0              | 24.5              |              |                                      |                         |  |   |                  |                    | 15           | £4.51           |

Also available in boxes. See page 28.

Grip range and test data are guide figures only



# LARGE FLANGE HEAD OPEN BLIND RIVET RAL 9005 BLACK

● **BODY:** Aluminium (AlMg3.5)

● **MANDREL:** Steel Zinc&Clr Tri3

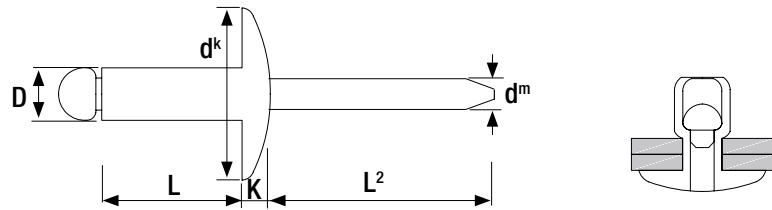

| Nominal Diameter mm (D) | Article Number | Body Length mm (L) | Grip Range Min mm | Grip Range Max mm | Hole Size mm | Flange Diameter mm (d <sup>k</sup> ) | Flange Thickness mm (K) | Nom. Mandrel Diameter mm (d <sup>m</sup> ) | Min Mandrel Length mm (L <sup>2</sup> ) | Shear Strength N | Tensile Strength N | Bag Quantity | Price £ Per Bag |
|-------------------------|----------------|--------------------|-------------------|-------------------|--------------|--------------------------------------|-------------------------|--|---|------------------|--------------------|--------------|-----------------|
| <b>4.8</b>              | JRP1175        | 10.0               | 3.5               | 5.5               | 4.9          | 16.0                                 | <b>2.5</b>              | 2.70                                       | 28.0                                    | 1540             | 2230               | 25           | <b>£4.51</b>    |
|                         | JRP1180        | 12.0               | 5.5               | 7.5               |              |                                      |                         |  |   |                  |                    | 25           | <b>£4.51</b>    |
|                         | JRP1185        | 14.0               | 7.5               | 9.5               |              |                                      |                         |  |   |                  |                    | 20           | <b>£4.51</b>    |
|                         | JRP1190        | 16.0               | 9.0               | 11.0              |              |                                      |                         |  |   |                  |                    | 20           | <b>£4.51</b>    |
|                         | JRP1195        | 20.0               | 13.0              | 15.0              |              |                                      |                         |  |   |                  |                    | 20           | <b>£4.51</b>    |
|                         | JRP1200        | 24.0               | 17.0              | 19.0              |              |                                      |                         |  |   |                  |                    | 20           | <b>£4.51</b>    |
|                         | JRP1205        | 26.0               | 19.5              | 21.0              |              |                                      |                         |  |   |                  |                    | 15           | <b>£4.51</b>    |

Also available in boxes. See page 30.

# DOME HEAD OPEN BLIND RIVET

- **BODY:** Steel Zinc&Clr Tri3
- **MANDREL:** Steel Zinc&Clr Tri3

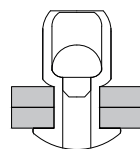
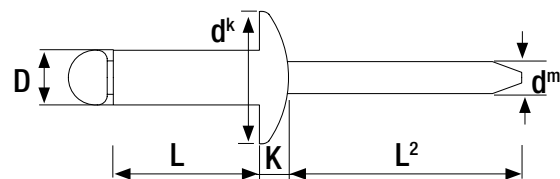

| Nominal Diameter mm (D) | Article Number | Body Length mm (L) | Grip Range Min mm | Grip Range Max mm | Hole Size mm | Flange Diameter mm (d <sup>k</sup> ) | Flange Thickness mm (K) | Nom. Mandrel Diameter mm (d <sup>m</sup> ) | Min Mandrel Length mm (L <sup>2</sup> ) | Shear Strength N | Tensile Strength N | Bag Quantity | Price £ Per Bag |
|-------------------------|----------------|--------------------|-------------------|-------------------|--------------|--------------------------------------|-------------------------|--|---|------------------|--------------------|--------------|-----------------|
| <b>3.2</b>              | JRP1070        | 6.0                | 1.5               | 3.0               | 3.3          | 6.5                                  | 0.8                     | 2.00                                       | 26.0                                    | 1060             | 1285               | 100          | £4.34           |
|                         | JRP1075        | 8.0                | 3.0               | 5.0               |              |                                      |                         |  |   |                  |                    | 100          | £4.34           |
|                         | JRP1080        | 10.0               | 5.0               | 7.0               |              |                                      |                         |  |   |                  |                    | 100          | £4.34           |
|                         | JRP1085        | 12.0               | 7.0               | 9.0               |              |                                      |                         |  |   |                  |                    | 100          | £4.34           |
| <b>4.0</b>              | JRP1090        | 8.0                | 2.0               | 4.0               | 4.1          | 8.0                                  | 1.0                     | 2.50                                       | 27.0                                    | 1550             | 1990               | 100          | £4.34           |
|                         | JRP1095        | 10.0               | 4.0               | 6.0               |              |                                      |                         |  |   |                  |                    | 100          | £4.34           |
|                         | JRP1100        | 12.0               | 6.0               | 8.0               |              |                                      |                         |  |   |                  |                    | 100          | £4.34           |
|                         | JRP1105        | 16.0               | 10.0              | 12.0              |              |                                      |                         |  |   |                  |                    | 50           | £4.34           |
| <b>4.8</b>              | JRP1110        | 10.0               | 3.5               | 5.5               | 4.9          | 9.5                                  | 1.1                     | 2.90                                       | 28.0                                    | 2300             | 2920               | 50           | £4.34           |
|                         | JRP1115        | 12.0               | 5.5               | 7.5               |              |                                      |                         |  |   |                  |                    | 50           | £4.34           |
|                         | JRP1120        | 16.0               | 9.0               | 11.0              |              |                                      |                         |  |   |                  |                    | 50           | £4.34           |
|                         | JRP1125        | 20.0               | 13.0              | 15.0              |              |                                      |                         |  |   |                  |                    | 50           | £4.34           |
|                         | JRP1130        | 25.0               | 17.0              | 20.0              |              |                                      |                         |  |   |                  |                    | 50           | £4.34           |
|                         | JRP1135        | 30.0               | 20.0              | 24.5              |              |                                      |                         |  |   |                  |                    | 25           | £4.34           |

Also available in boxes. See page 32.

Grip range and test data are guide figures only



# DOME HEAD JRP-LOCK STRUCTURAL BLIND RIVET

- BODY:** Steel Zinc&Clr Tri3
- MANDREL:** Steel Zinc&Clr Tri3 (Grooved)

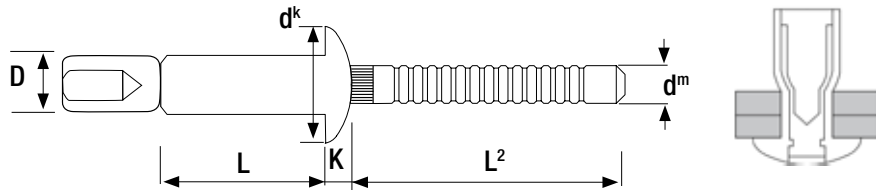

| Nominal Diameter mm (D) | Article Number | Body Length mm (L) | Grip Range Min mm | Grip Range Max mm | Hole Size mm | Flange Diameter mm (d <sup>k</sup> ) | Flange Thickness mm (K) | Nom. Mandrel Diameter mm (d <sup>m</sup> ) | Min Mandrel Length mm (L <sup>2</sup> ) | Shear Strength N | Tensile Strength N | Mandrel Retention Strength N | Bag Quantity | Price £ Per Bag |
|-------------------------|----------------|--------------------|-------------------|-------------------|--------------|--------------------------------------|-------------------------|--|---|------------------|--------------------|------------------------------|--------------|-----------------|
| <b>4.8</b>              | JRP1225        | 10.5               | 1.8               | 6.9               | 4.9-5.1      | 10.0                                 | 2.2                     | 3.00                                       | 26.0                                    | 5700             | 4400               | 445                          | 25           | <b>£5.68</b>    |
|                         | JRP1230        | 14.5               | 1.8               | 11.0              |              |                                      |                         |  |   |                  |                    |                              | 25           | <b>£5.68</b>    |

Also available in boxes. See page 68.

# DOME HEAD MULTIGRIP BLIND RIVET

- **BODY:** A2 Stainless Steel (AISI304)
- **MANDREL:** A2 Stainless Steel (AISI304) (Grooved)

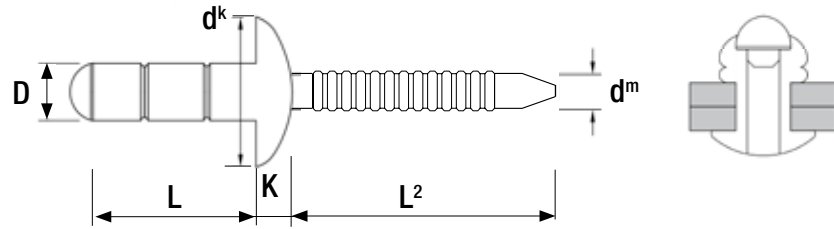

| Nominal Diameter mm (D) | Article Number | Body Length mm (L) | Grip Range Min mm | Grip Range Max mm | Hole Size mm | Flange Diameter mm (d <sup>k</sup> ) | Flange Thickness mm (K) | Nom. Mandrel Diameter mm (d <sup>m</sup> ) | Min Mandrel Length mm (L <sup>2</sup> ) | Shear Strength N | Tensile Strength N | Bag Quantity | Price £ Per Bag |
|-------------------------|----------------|--------------------|-------------------|-------------------|--------------|--------------------------------------|-------------------------|--|---|------------------|--------------------|--------------|-----------------|
| <b>4.8</b>              | JRP1210        | 12.0               | 3.0               | 6.5               | 4.9          | 9.8                                  | 1.8                     | 3.20                                       | 28.0                                    | 4000             | 5000               | 25           | £6.35           |
|                         | JRP1215        | 15.0               | 6.5               | 9.0               |              |                                      |                         |  |   |                  |                    | 25           | £6.35           |
|                         | JRP1220        | 17.5               | 9.0               | 12.5              |              |                                      |                         |  |   |                  |                    | 25           | £6.35           |

Also available in boxes. See page 53.

Grip range and test data are guide figures only

# DOME HEAD JRP-LOCK STRUCTURAL BLIND RIVET

- BODY:** A2 Stainless Steel (AISI302)
- MANDREL:** A2 Stainless Steel (AISI304) (Grooved)

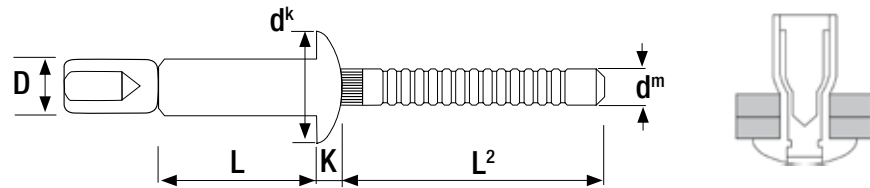

| Nominal Diameter mm (D) | Article Number | Body Length mm (L) | Grip Range Min mm | Grip Range Max mm | Hole Size mm | Flange Diameter mm (d <sup>k</sup> ) | Flange Thickness mm (K) | Nom. Mandrel Diameter mm (d <sup>m</sup> ) | Min Mandrel Length mm (L <sup>2</sup> ) | Shear Strength N | Tensile Strength N | Mandrel Retention Strength N | Bag Quantity | Price £ Per Bag |
|-------------------------|----------------|--------------------|-------------------|-------------------|--------------|--------------------------------------|-------------------------|--|---|------------------|--------------------|------------------------------|--------------|-----------------|
| 4.8                     | JRP1235        | 10.5               | 1.8               | 6.9               | 4.9-5.1      | 10.0                                 | 2.2                     | 3.00                                       | 26.0                                    | 5700             | 4400               | 445                          | 25           | £9.85           |
|                         | JRP1240        | 14.5               | 1.8               | 11.0              |              |                                      |                         |  |   |                  |                    |                              | 25           | £9.85           |

Also available in boxes. See page 72.



# RIVET NUTS

# BLIND RIVET NUT HEAD STYLES

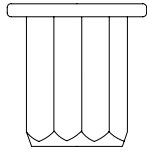

## FLAT HEAD

The flat head is the most common and multifunctional head style. It can be used in a conventional way of fixing into one piece of material, or used in multiple materials to clamp them together; similar to a blind rivet connection.

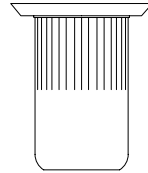

## COUNTERSUNK HEAD

The countersunk head is used where a flush or non-interference fit is required. The hole on the installation side of the material needs to ensure the countersink is a little bit deeper than the countersunk head thickness itself. This allows the head of the nut to sit just below the surface of the material after being set by the setting tool, giving a non-interference fit. As with flat head, it can be used in a conventional way of fixing into one piece of material, or used in multiple materials to clamp them together.

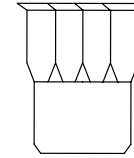

## REDUCED HEAD

The reduced head is a specialist version of the countersunk head. It can be used where a flush type finish is required where a non-interference fit is not critical. The rivet nut can be set without the need to produce a specialised hole, therefore is a more cost-effective fixing choice. The reduced head is ideal for very thin sheet materials where a countersink hole could not be produced due to insufficient material thickness. Due to the reduced head, and smaller grip range availability, this product is more suited to single thin sheet materials.

## MATERIALS INDEX



Steel Zinc&Clr Tri8



A2 Stainless Steel



A4 Stainless Steel



Aluminium

# THE JRP BLIND RIVET NUT RANGE

|  |  | Aluminium | Steel Zinc&Clr Tri8 | A2 Stainless Steel | A4 Stainless Steel |
|---|--|-----------|---------------------|--------------------|--------------------|
| ROUND   | Flat Head Round Knurled Body Open Blind Rivet Nut                    | M3-M12    | M3-M12              | M3-M12             | M3-M12             |
|   | Csk Head Round Knurled Body Open Blind Rivet Nut                     | M3-M12    | M3-M12              | M3-M12             | M3-M10             |
|   | Reduced Head Round Knurled Body Open Blind Rivet Nut (Metric Body)   | M3-M10    | M3-M12              | M3-M12             | M3-M10             |
|   | Reduced Head Round Knurled Body Open Blind Rivet Nut (Imperial Body) |           | M3-M10              |                    |                    |
|   | Flat Head Round Knurled Body Closed Blind Rivet Nut                  |           | M3-M10              | M3-M10             |                    |
|   | Csk Head Round Knurled Body Closed Blind Rivet Nut                   |           | M3-M10              | M4-M10             |                    |
|   | Reduced Head Round Knurled Body Closed Rivet Nut (NEW)               |           | M4-M10              | M3-M10             | M3-M10             |
|   | Flat Head Round JK Split Body Open Blind Rivet Nut (NEW) (*)         |           | M4-M8**             |                    |                    |
|   | Flat Head Round PN Heavy Duty Split Body Open Blind Rivet Nut (NEW)  |           | M5-M10              |                    |                    |
|   | Flat Head Round US Knurled Body Open Blind Rivet Nut (NEW)           |           | M4-M10              |                    |                    |
|   | Reduced Head Round US Knurled Body Open Rivet Nut (NEW)              |           | M4-M10              |                    |                    |
| HEXAGON   | Flat Head Full Hexagon Body Open Blind Rivet Nut                     |           | M4-M12              |                    |                    |
|   | Reduced Head Full Hexagon Body Open Blind Rivet Nut                  |           | M4-M12              |                    |                    |
|   | Flat Head Part Hexagon Body Open Blind Rivet Nut                     |           | M4-M10              | M4-M10             | M4-M10             |
|   | Reduced Head Part Hexagon Body Open Blind Rivet Nut                  |           | M4-M10              | M4-M10             | M4-M10             |
|   | Reduced Head Part Hexagon Body Closed (NEW)                          |           | M4-M10              | M4-M10             | M4-M10             |

Data = Thread Size

(\*) Please note we do not recommend you use this product in hard materials exceeding 8.0mm or if a high torque load is required.

\*\* Steel Zinc&Clr Tri3

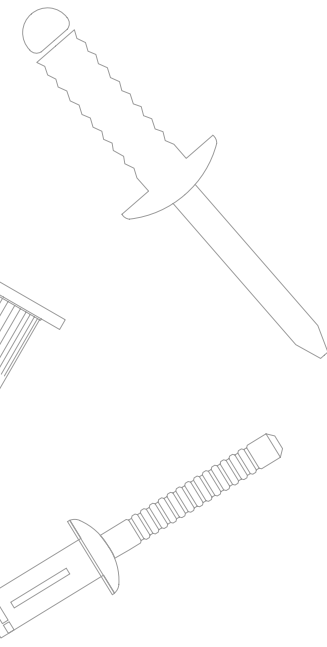

# BLIND RIVET NUT TYPES

Rivet nuts come in two main body types - round or hexagon with either an open or closed-end.

**Open End** – allows an oversized fastener to screw all the way through, proving vibration resistance.

**Closed End** – creates a watertight application using an exact sized screw.

**ROUND**  
open end



**ROUND**  
closed end



**HEXAGON**  
open end



**HEXAGON**  
closed end



**SPLIT**  
JK



**SPLIT**  
PN



# BLIND RIVET NUT TYPES

## FLAT HEAD ROUND KNURLED BODY OPEN BLIND RIVET NUT



The most common and widely used rivet nut range. Used in a multitude of industries such as aerospace, automotive, rail, HVAC, white goods, electronics, DIY and general engineering.



## COUNTERSUNK HEAD ROUND KNURLED BODY OPEN BLIND RIVET NUT



Similar to flat head nuts, but where a flush surface finish is required. Used in a multitude of industries such as aerospace, automotive, rail, HVAC, white goods, electronics, DIY and general engineering.



## REDUCED HEAD KNURLED ROUND BODY OPEN BLIND RIVET NUT



Similar to countersunk head where a 'flush fit' is required without the need for a countersunk hole. Used in a multitude of industries such as aerospace, automotive, rail, HVAC, white goods, electronics, DIY and general engineering.



## FLAT HEAD ROUND KNURLED BODY CLOSED BLIND RIVET NUT



Similar to round open rivet nuts, but used when a moisture or pressure-tight seal is required. Used in white goods, electrical enclosures, indoor and outdoor electronic signs, automotive, aerospace, rail and HVAC.



## COUNTERSUNK HEAD ROUND KNURLED BODY CLOSED BLIND RIVET NUT



Similar to countersunk round open but used when a moisture or pressure-tight seal is required. Used in white goods, electrical enclosures, indoor and outdoor electronic signs, automotive, aerospace, rail and HVAC.



## REDUCED HEAD ROUND KNURLED BODY CLOSED BLIND RIVET NUT



Similar to countersunk head where a "flush fit" is required without the need for countersunk hole and when a moisture or pressure-tight seal is also required. Used in white goods, electrical enclosures, indoor and outdoor electronic signs, automotive, aerospace, rail and HVAC.





### FLAT HEAD FULL HEXAGON BODY OPEN BLIND RIVET NUT



Primarily used where a high resistance thread and anti-rotation is required. Ideal in thin sheet metals. Used in a multitude of industries such as aerospace, automotive, rail, HVAC, white goods, electronics, as well as the manufacture of heavy goods, bumper systems, seating and vehicle chassis.



### FLAT HEAD PART HEXAGON BODY OPEN BLIND RIVET NUT



Similar to flat head full hexagon open with a slight reduction in torque loadings. Used in a multitude of industries such as aerospace, automotive, rail, HVAC, white goods, electronics, as well as the manufacture of heavy goods, bumper systems, seating and vehicle chassis.



### REDUCED HEAD FULL HEXAGON BODY OPEN BLIND RIVET NUT



Similar to flat head full hexagon open but where a 'flush fit' is required without a countersunk hole. Used in a multitude of industries such as aerospace, automotive, rail, HVAC, white goods, electronics, as well as the manufacture of heavy goods, bumper systems, seating and vehicle chassis.



### REDUCED HEAD PART HEXAGON BODY OPEN BLIND RIVET NUT



Exactly the same as reduced head full hexagon but with a slight reduction in torque loading. Used in a multitude of industries such as aerospace, automotive, rail, HVAC, white goods, electronics, as well as the manufacture of heavy goods, bumper systems, seating and vehicle chassis.



### REDUCED HEAD PART HEXAGON BODY CLOSED BLIND RIVET NUT



Exactly the same as reduced head part hexagon but where a moisture or pressure-tight seal is also required. Used in white goods, electrical enclosures, indoor and outdoor electronic signs, automotive, aerospace, rail and HVAC, where a higher torque loading is required.



### FLAT HEAD ROUND JK SPLIT BODY OPEN BLIND RIVET NUT



JK split body rivet nuts are ideal for use in soft or brittle materials such as composites, plastic, GRP and some card based materials. The legs expand on the blindside of the parent material to provide a load-bearing footprint. (Not suitable if a high torque load is required). Used in automotive, rail, electronic signs, glazing, modular buildings and commercial vehicles.



### FLAT HEAD ROUND PN HEAVY DUTY SPLIT BODY OPEN BLIND RIVET NUT



Heavy duty PN split body rivet nuts are ideal for use in composites, plastics, GRP and thin sheet metals where very high pull-out forces are required. The legs expand on the blindside of the parent material to provide a load-bearing footprint and high torque loading. Used in aerospace, automotive, rail, general engineering, construction, modular buildings, fall arrest systems and commercial vehicles.



### FLAT HEAD US ROUND KNURLED BODY OPEN BLIND RIVET NUT



Flat head US Style rivet nuts have a thin wall to allow for a larger grip range. They have a larger body diameter than other types of rivet nuts, which makes them ideal for use in oversize holes. Used in aerospace, automotive, rail, general engineering, construction, modular buildings, electronics and commercial vehicles.



### REDUCED HEAD US ROUND KNURLED BODY OPEN BLIND RIVET NUT



Reduced head US style rivet nuts are exactly like the flat head US style but where a "flush fit" is required without the need for a countersunk hole. They have a larger body diameter than other types of rivet nuts, which makes them ideal for use in oversize holes. Used in aerospace, automotive, rail, general engineering, construction, modular buildings, electronics and commercial vehicles.



# PRODUCT SUITABILITY GUIDE

| RIVET NUT TYPE  | Aerospace | Automotive | Rail | HVAC | White Goods | Electrical Enclosures | Electronic Signs | Electronics | General Engineering | DIY | Glazing | Roofing | Windows | Cladding | Insulation | Construction | Flight Cases | Modular Buildings | Storage Solutions | Fall Arrest Systems | Commercial Vehicles |  |
|---|-----------|------------|------|------|-------------|-----------------------|------------------|-------------|---------------------|-----|---------|---------|---------|----------|------------|--------------|--------------|-------------------|-------------------|---------------------|---------------------|--|
| Flat Head Round Knurled Body Open                               |           |            |      |      |             |                       |                  |             |                     |     |         |         |         |          |            |              |              |                   |                   |                     |                     |  |
| Flat Head Round Knurled Body Closed                             |           |            |      |      |             |                       |                  |             |                     |     |         |         |         |          |            |              |              |                   |                   |                     |                     |  |
| Csk Head Round Knurled Body Open                                |           |            |      |      |             |                       |                  |             |                     |     |         |         |         |          |            |              |              |                   |                   |                     |                     |  |
| Csk Head Round Knurled Body Closed                              |           |            |      |      |             |                       |                  |             |                     |     |         |         |         |          |            |              |              |                   |                   |                     |                     |  |
| Reduced Head Round Knurled Body Open (Metric and Imperial Body) |           |            |      |      |             |                       |                  |             |                     |     |         |         |         |          |            |              |              |                   |                   |                     |                     |  |
| Reduced Head Round Knurled Body Closed (NEW)                    |           |            |      |      |             |                       |                  |             |                     |     |         |         |         |          |            |              |              |                   |                   |                     |                     |  |
| Flat Head Round JK Split Body Open (NEW) (*)                    |           |            |      |      |             |                       |                  |             |                     |     |         |         |         |          |            |              |              |                   |                   |                     |                     |  |
| Flat Head Round PN Heavy Duty Split Body Open (NEW)             |           |            |      |      |             |                       |                  |             |                     |     |         |         |         |          |            |              |              |                   |                   |                     |                     |  |
| Flat Head Round US Knurled Body Open (NEW)                      |           |            |      |      |             |                       |                  |             |                     |     |         |         |         |          |            |              |              |                   |                   |                     |                     |  |
| Reduced Head Round US Knurled Body Open (NEW)                   |           |            |      |      |             |                       |                  |             |                     |     |         |         |         |          |            |              |              |                   |                   |                     |                     |  |

 = Ideal for this application    (\*) Please note we do not recommend you use this product in hard materials exceeding 8.0mm or if a high torque load is required.



| RIVET NUT TYPE                              | Aerospace | Automotive | Rail | HVAC | White Goods | Electrical Enclosures | Electronic Signs | Electronics | General Engineering | DIY | Glazing | Roofing | Windows | Cladding | Insulation | Construction | Flight Cases | Modular Buildings | Storage Solutions | Fall Arrest Systems | Commercial Vehicles |  |
|---|-----------|------------|------|------|-------------|-----------------------|------------------|-------------|---------------------|-----|---------|---------|---------|----------|------------|--------------|--------------|-------------------|-------------------|---------------------|---------------------|--|
| Flat Head Full Hexagon Body Open            |           |            |      |      |             |                       |                  |             |                     |     |         |         |         |          |            |              |              |                   |                   |                     |                     |  |
| Flat Head Part Hexagon Body Open            |           |            |      |      |             |                       |                  |             |                     |     |         |         |         |          |            |              |              |                   |                   |                     |                     |  |
| Reduced Head Full Hexagon Body Open         |           |            |      |      |             |                       |                  |             |                     |     |         |         |         |          |            |              |              |                   |                   |                     |                     |  |
| Reduced Head Part Hexagon Body Open         |           |            |      |      |             |                       |                  |             |                     |     |         |         |         |          |            |              |              |                   |                   |                     |                     |  |
| Reduced Head Part Hexagon Body Closed (NEW) |           |            |      |      |             |                       |                  |             |                     |     |         |         |         |          |            |              |              |                   |                   |                     |                     |  |



# SELECTING THE RIGHT **BLIND RIVET NUT**

**As with rivets, a user must take into account a number of considerations when choosing the right rivet nut to use. We have put together some guidance to help you as a supplier, advise your customers how to select the right one for their application.**

## **MATERIAL CHOICE**

Both the rivet nut and the materials to be fastened will affect the ultimate joint strength. The rivet nut body material selection would generally be the same as the material(s) being assembled i.e. an aluminium body into an aluminium section. A marked dissimilarity of materials may cause joint failure due either to material fatigue or galvanic corrosion.

## **BLIND RIVET NUT HEAD STYLE**

The flat head rivet nut is appropriate for most applications including when soft or brittle materials are fastened to a rigid backing member. This will spread the load over a greater surface area. Where a flush surface is required, the countersunk head rivet style should be selected if there is enough material thickness to form a countersunk hole, slightly deeper than the head thickness of the rivet nut. If not, or the material is very thin material, then a reduced head version would be more suitable.

## **HOLE SIZE**

Hole size can be important in blind riveting. Too small a hole will, of course, make rivet nut insertion difficult and conversely too big a hole will cause a rivet nut to fail. Best practice is to follow the hole size recommendations provided in the technical data.

## **JOINT THICKNESS (GRIP RANGE)**

Firstly, measure the total thickness of the materials to be joined. This determines the required "grip" of the rivet nut you select. Refer to the "Grip Range" column and select a rivet nut with a grip range that includes the thickness required. Please note, that insufficient rivet nut length will not allow proper deformation at the back of the work and could result in rivet nut failure.

## **RIVET JOINT STRENGTH**

The single-joint tensile and shear values vary from application to application. The functions of total joint strength, fastener spacing, rivet nut body material and rivet nut diameter are all factors that result in the final shear and tensile strengths required. Refer to the technical data supplied for typical strength values.

**The above information should be used in conjunction with the technical data found on pages 94 to 118 for the individual ranges of JRP blind rivet nuts.**





# TECHNICAL DATA

## HOW TO MEASURE A BLIND RIVET NUT

**Flat Head** - the rivet nut body length (L) is always measured overall.

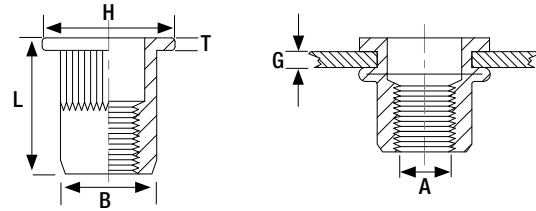

**B** = body diameter  
**L** = body length  
**H** = rivet nut head diameter  
**T** = rivet nut head thickness  
**A** = thread size  
**G** = grip range

**Countersunk Head or Reduced Head** - the rivet body length (L) is always measured from the top of the head to the end of the body.

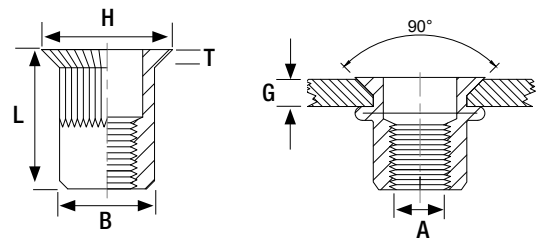

**B** = body diameter  
**L** = body length  
**H** = rivet nut head diameter  
**T** = rivet nut head thickness  
**A** = thread size  
**G** = grip range

## HOW TO INSTALL A BLIND RIVET NUT

Blind rivet nuts have a simple and rapid installation.

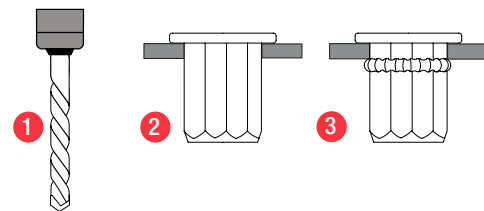

- 1 Firstly drill the hole.
- 2 To set the nut, screw it onto the threaded mandrel of the setting tool, and insert into the component hole. The nut is then set through the stroke of the setting tool pulling it up onto the material. This causes the collapsible part of the nut to form on the rear of the material or blindside.
- 3 After the threaded mandrel of the setting tool is removed, the rivet nut thread is left ready for use.

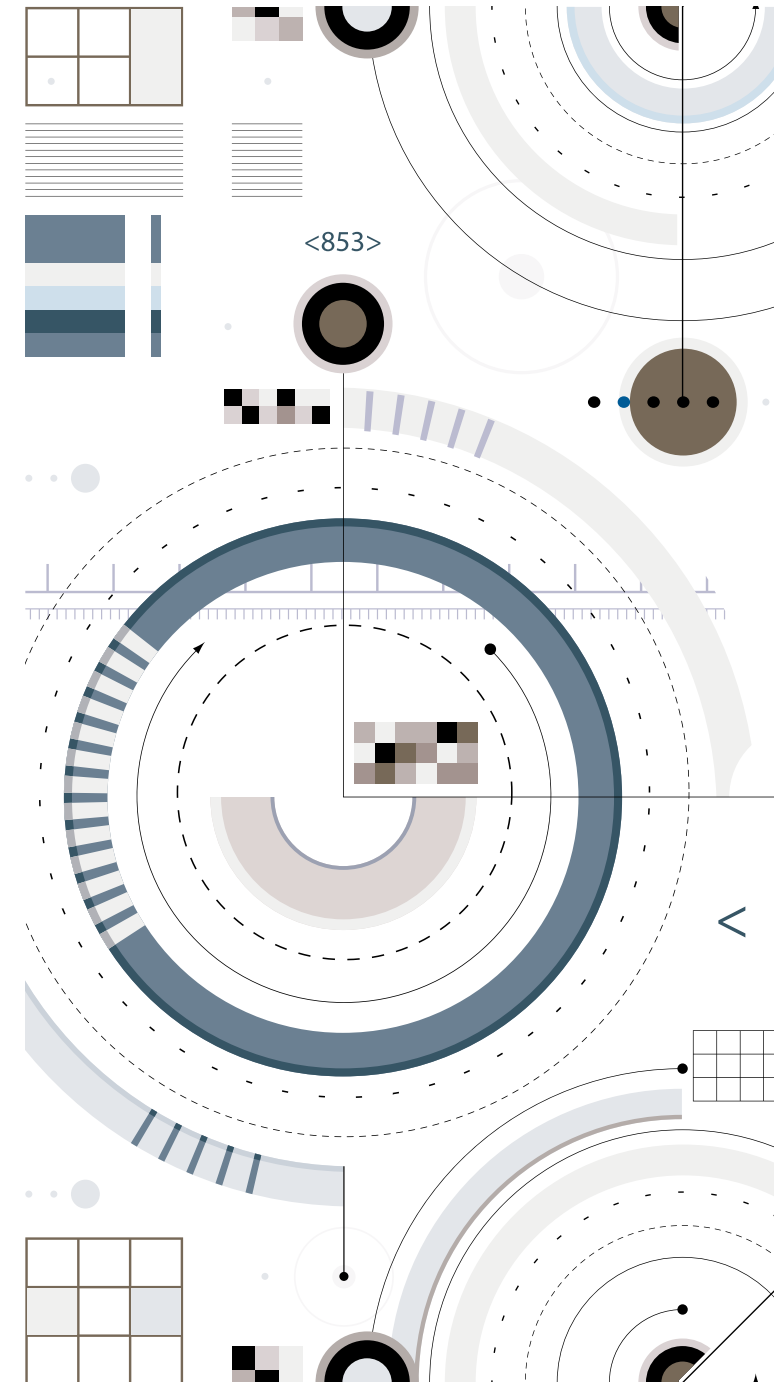

# FLAT HEAD ROUND KNURLED BODY OPEN BLIND RIVET NUT

Steel Zinc&Clr Tri8 (AISI1008)

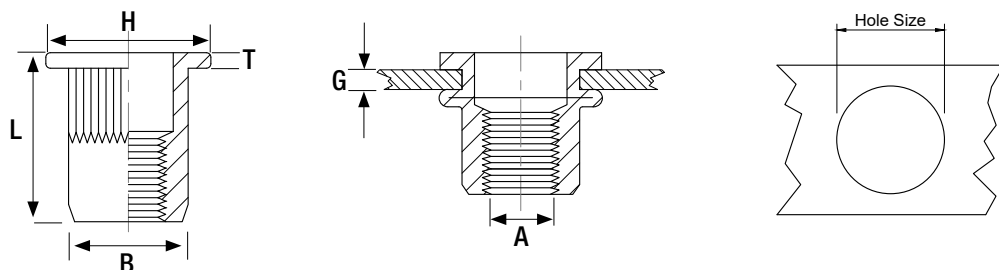

| Thread Size mm (A) | Article Number | Grip Range Min mm (G) | Grip Range Max mm (G) | Hole Size mm | Body Diameter mm (B) | Flange Diameter mm (H) | Flange Thickness mm (T) | Body Overall Length mm (L) | Max Tightening Torque Nm | Tensile Strength N | Box Quantity | Price £ Per 1000 |
|--------------------|----------------|-----------------------|-----------------------|--------------|----------------------|------------------------|-------------------------|----------------------------|--------------------------|--------------------|--------------|------------------|
| <b>M3</b>          | RNSFH0315      | 0.5                   | 1.5                   | 5.0          | 4.9                  | 8.0                    | 0.8                     | 10.0                       | 1.0                      | 3900               | 2000         | £32.91           |
|                    | RNSFH0335      | 2.0                   | 3.5                   |              |                      |                        |                         | 11.5                       |                          |                    | 2000         | £40.43           |
| <b>M4</b>          | RNSFH0420      | 0.5                   | 2.0                   | 6.0          | 5.9                  | 9.0                    | 0.9                     | 10.5                       | 3.0                      | 6800               | 1500         | £29.55           |
|                    | RNSFH0435      | 2.0                   | 3.5                   |              |                      |                        |                         | 12.0                       |                          |                    | 1500         | £38.18           |
| <b>M5</b>          | RNSFH0525      | 0.5                   | 2.5                   | 7.0          | 6.9                  | 10.0                   | 1.0                     | 13.0                       | 6.0                      | 10000              | 1000         | £34.13           |
|                    | RNSFH0550      | 2.5                   | 5.0                   |              |                      |                        |                         | 16.5                       |                          |                    | 500          | £42.69           |
|                    | RNSFH0580      | 5.0                   | 8.0                   |              |                      |                        |                         | 19.0                       |                          |                    | 350          | £42.69           |
| <b>M6</b>          | RNSFH0630      | 0.5                   | 3.0                   | 9.0          | 8.9                  | 12.3                   | 1.3                     | 15.5                       | 10.0                     | 15000              | 500          | £39.74           |
|                    | RNSFH0655      | 3.0                   | 5.5                   |              |                      |                        |                         | 19.5                       |                          |                    | 400          | £44.13           |
|                    | RNSFH0680      | 5.5                   | 8.0                   |              |                      |                        |                         | 21.0                       |                          |                    | 300          | £49.28           |
| <b>M8</b>          | RNSFH0835      | 1.0                   | 3.5                   | 11.0         | 10.9                 | 14.5                   | 1.5                     | 18.5                       | 24.0                     | 27000              | 250          | £68.90           |
|                    | RNSFH0860      | 3.5                   | 6.0                   |              |                      |                        |                         | 21.0                       |                          |                    | 250          | £70.67           |
|                    | RNSFH0880      | 5.0                   | 8.0                   |              |                      |                        |                         | 23.0                       |                          |                    | 200          | £81.59           |
| <b>M10</b>         | RNSFH1040      | 1.0                   | 4.0                   | 13.0         | 12.9                 | 17.0                   | 1.7                     | 21.5                       | 32.0                     | 28500              | 250          | £112.83          |
|                    | RNSFH1065      | 4.0                   | 6.5                   |              |                      |                        |                         | 24.0                       |                          |                    | 200          | £115.80          |
|                    | RNSFH1090      | 6.5                   | 9.0                   |              |                      |                        |                         | 27.0                       |                          |                    | 100          | £155.59          |
| <b>M12</b>         | RNSFH1240      | 1.0                   | 4.0                   | 16.0         | 15.9                 | 22.0                   | 2.0                     | 25.0                       | 44.0                     | 48000              | 100          | £221.89          |
|                    | RNSFH1260      | 3.5                   | 6.0                   |              |                      |                        |                         | 28.0                       |                          |                    | 80           | £232.03          |

# COUNTERSUNK HEAD ROUND KNURLED BODY OPEN BLIND RIVET NUT

Steel Zinc&Clr Tri8 (AISI1008)

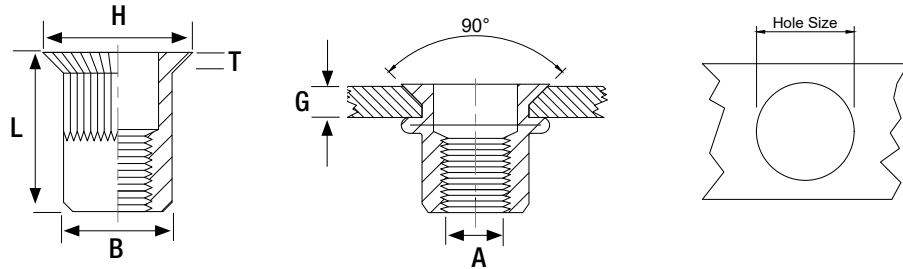

| Thread Size mm (A) | Article Number | Grip Range Min mm (G) | Grip Range Max mm (G) | Hole Size mm | Body Diameter mm (B) | Flange Diameter mm (H) | Flange Thickness mm (T) | Body Overall Length mm (L) | Max Tightening Torque Nm | Tensile Strength N | Box Quantity   | Price £ Per 1000 |
|--------------------|----------------|-----------------------|-----------------------|--------------|----------------------|------------------------|-------------------------|----------------------------|--------------------------|--------------------|----------------|------------------|
| <b>M3</b>          | RNSCH0325      | 1.5                   | 2.5                   | 5.0          | 4.9                  | 7.5                    | 1.5                     | 9.5                        | 1.0                      | 3900               | 2000           | <b>£45.53</b>    |
|                    | RNSCH0340      | 2.5                   | 4.0                   |              |                      |                        |                         | 10.5                       |                          |                    | 2000           | <b>£43.33</b>    |
| <b>M4</b>          | RNSCH0430      | 1.5                   | 3.0                   | 6.0          | 5.9                  | 8.5                    |                         | 12.0                       | 3.0                      | 6800               | 1500           | <b>£39.40</b>    |
|                    | RNSCH0450      | 3.0                   | 5.0                   |              |                      |                        |                         | 13.0                       |                          |                    | 1500           | <b>£43.63</b>    |
| <b>M5</b>          | RNSCH0535      | 2.0                   | 3.5                   | 7.0          | 6.9                  | 10.0                   |                         | 13.0                       | 6.0                      | 10000              | 1000           | <b>£45.50</b>    |
|                    | RNSCH0550      | 3.0                   | 5.0                   |              |                      |                        |                         | 15.0                       |                          |                    | 500            | <b>£49.09</b>    |
| <b>M6</b>          | RNSCH0640      | 1.5                   | 4.0                   | 9.0          | 8.9                  | 12.0                   |                         | 15.5                       | 10.0                     | 15000              | 500            | <b>£52.99</b>    |
|                    | RNSCH0660      | 4.0                   | 6.0                   |              |                      |                        |                         | 17.0                       |                          |                    | 400            | <b>£58.84</b>    |
| <b>M8</b>          | RNSCH0845      | 2.0                   | 4.5                   | 11.0         | 10.9                 | 14.0                   |                         | 18.5                       | 24.0                     | 27000              | 250            | <b>£91.88</b>    |
|                    | RNSCH0860      | 4.5                   | 6.0                   |              |                      |                        |                         | 19.0                       |                          |                    | 250            | <b>£94.22</b>    |
| <b>M10</b>         | RNSCH1050      | 2.0                   | 5.0                   | 13.0         | 12.9                 | 16.0                   | 21.0                    | 32.0                       | 28500                    | 250                | <b>£150.45</b> |                  |
|                    | RNSCH1065      | 3.5                   | 6.5                   |              |                      |                        | 24.0                    |                            |                          | 250                | <b>£154.41</b> |                  |
| <b>M12</b>         | RNSCH1250      | 2.0                   | 5.0                   | 16.0         | 15.9                 | 19.0                   | 24.0                    | 44.0                       | 48000                    | 100                | <b>£295.85</b> |                  |
|                    | RNSCH1270      | 5.0                   | 7.0                   |              |                      |                        | 29.0                    |                            |                          | 100                | <b>£309.37</b> |                  |

Grip range and test data are guide figures only



# REDUCED HEAD ROUND KNURLED BODY (Metric) OPEN BLIND RIVET NUT

Steel Zinc&Clr Tri8 (AISI1008)

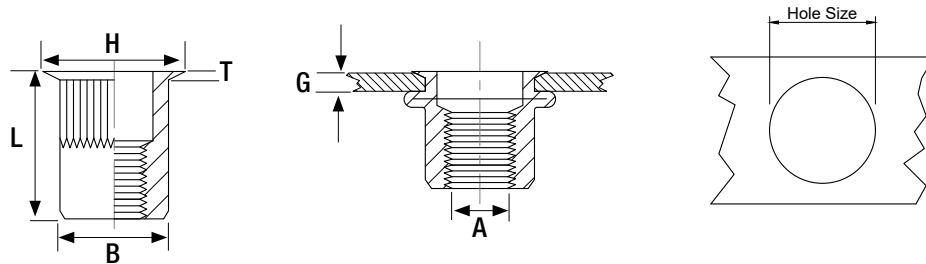

| Thread Size mm (A) | Article Number | Grip Range Min mm (G) | Grip Range Max mm (G) | Hole Size mm | Body Diameter mm (B) | Flange Diameter mm (H) | Flange Thickness mm (T) | Body Overall Length mm (L) | Max Tightening Torque Nm | Tensile Strength N | Box Quantity | Price £ Per 1000 |
|--------------------|----------------|-----------------------|-----------------------|--------------|----------------------|------------------------|-------------------------|----------------------------|--------------------------|--------------------|--------------|------------------|
| <b>M3</b>          | RNSRH0320      | 0.5                   | 2.0                   | 5.0          | 4.9                  | 6.0                    | 0.5                     | 9.0                        | 1.0                      | 3900               | 2000         | £41.18           |
|                    | RNSRH0335      | 1.5                   | 3.0                   |              |                      |                        |                         | 11.5                       |                          |                    | 2000         | £39.19           |
| <b>M4</b>          | RNSRH0420      | 0.5                   | 2.0                   | 6.0          | 5.9                  | 7.0                    | 0.5                     | 11.5                       | 3.0                      | 6800               | 1500         | £35.65           |
|                    | RNSRH0440      | 2.0                   | 4.0                   |              |                      |                        |                         | 13.0                       |                          |                    | 1500         | £46.06           |
| <b>M5</b>          | RNSRH0520      | 0.5                   | 2.0                   | 7.0          | 6.9                  | 8.0                    | 0.5                     | 11.5                       | 6.0                      | 10000              | 1000         | £39.12           |
|                    | RNSRH0540      | 2.0                   | 4.0                   |              |                      |                        |                         | 13.0                       |                          |                    | 500          | £50.09           |
| <b>M6</b>          | RNSRH0625      | 0.5                   | 2.5                   | 9.0          | 8.9                  | 10.0                   | 0.6                     | 14.0                       | 10.0                     | 15000              | 500          | £47.94           |
|                    | RNSRH0650      | 2.5                   | 5.0                   |              |                      |                        |                         | 16.0                       |                          |                    | 400          | £53.24           |
| <b>M8</b>          | RNSRH0830      | 0.5                   | 3.0                   | 11.0         | 10.9                 | 12.0                   | 0.7                     | 16.5                       | 24.0                     | 27000              | 250          | £64.74           |
|                    | RNSRH0850      | 3.0                   | 5.0                   |              |                      |                        |                         | 18.5                       |                          |                    | 250          | £65.80           |
| <b>M10</b>         | RNSRH1035      | 1.0                   | 3.5                   | 13.0         | 12.9                 | 14.0                   | 0.7                     | 19.5                       | 32.0                     | 28500              | 250          | £111.37          |
|                    | RNSRH1060      | 3.5                   | 6.0                   |              |                      |                        |                         | 22.0                       |                          |                    | 250          | £114.30          |
| <b>M12</b>         | RNSRH1240      | 1.0                   | 4.0                   | 16.0         | 15.9                 | 17.5                   | 0.8                     | 24.0                       | 44.0                     | 48000              | 100          | £312.29          |
|                    | RNSRH1265      | 4.0                   | 6.5                   |              |                      |                        |                         | 27.5                       |                          |                    | 100          | £279.91          |



# REDUCED HEAD ROUND KNURLED BODY (Imperial) OPEN BLIND RIVET NUT

Steel Zinc&Clr Tri8 (AISI1008)

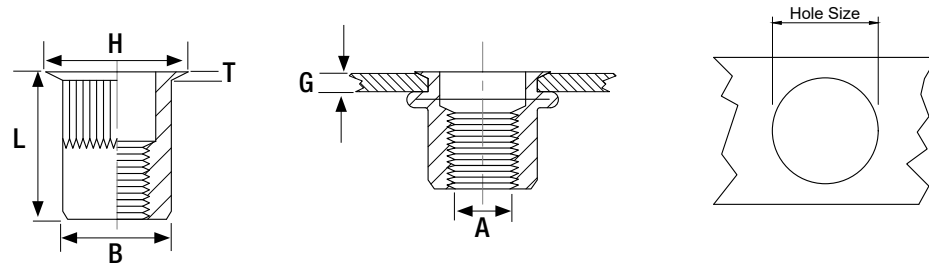

| Thread Size mm (A) | Article Number | Grip Range Min mm (G) | Grip Range Max mm (G) | Hole Size mm | Body Diameter mm (B) | Flange Diameter mm (H) | Flange Thickness mm (T) | Body Overall Length mm (L) | Max Tightening Torque Nm | Tensile Strength N | Box Quantity | Price £ Per 1000 |
|--------------------|----------------|-----------------------|-----------------------|--------------|----------------------|------------------------|-------------------------|----------------------------|--------------------------|--------------------|--------------|------------------|
| <b>M3</b>          | RNSRHIO315     | 0.5                   | 1.5                   | 4.8          | 4.7                  | 5.4                    | 0.4                     | 9.0                        | 1.0                      | 3900               | 1500         | <b>£44.57</b>    |
| <b>M4</b>          | RNSRHIO420     | 0.5                   | 2.0                   | 6.4          | 6.3                  | 7.0                    | 0.5                     | 10.5                       | 3.0                      | 6800               | 1500         | <b>£46.75</b>    |
| <b>M5</b>          | RNSRHIO525     | 0.5                   | 2.5                   | 7.2          | 7.1                  | 7.8                    | 0.5                     | 12.0                       | 6.0                      | 10000              | 1000         | <b>£48.19</b>    |
| <b>M6</b>          | RNSRHIO630     | 1.0                   | 3.0                   | 9.6          | 9.5                  | 10.3                   | 0.6                     | 15.0                       | 10.0                     | 15000              | 400          | <b>£63.02</b>    |
| <b>M8</b>          | RNSRHIO835     | 1.0                   | 3.5                   | 10.6         | 10.5                 | 11.3                   | 0.6                     | 16.0                       | 24.0                     | 27000              | 250          | <b>£102.17</b>   |

*Grip range and test data are guide figures only*



# FLAT HEAD FULL HEXAGON BODY OPEN BLIND RIVET NUT

Steel Zinc&Clr Tri8 (AISI1008)

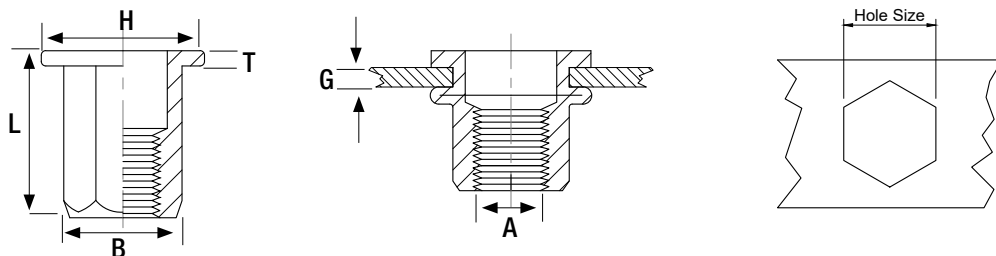

| Thread Size mm (A) | Article Number | Grip Range Min mm (G) | Grip Range Max mm (G) | Hole Size mm | Body Diameter mm (B) | Flange Diameter mm (H) | Flange Thickness mm (T) | Body Overall Length mm (L) | Max Tightening Torque Nm | Tensile Strength N | Box Quantity | Price £ Per 1000 |
|--------------------|----------------|-----------------------|-----------------------|--------------|----------------------|------------------------|-------------------------|----------------------------|--------------------------|--------------------|--------------|------------------|
| <b>M4</b>          | RNSFHH0420     | 0.5                   | 2.0                   | 6.0          | 5.9                  | 9.0                    | 0.8                     | 11.0                       | 4.0                      | 6800               | 1500         | <b>£46.20</b>    |
| <b>M5</b>          | RNSFHH0525     | 0.5                   | 2.5                   | 7.0          | 6.9                  | 10.0                   | 1.0                     | 14.0                       | 6.5                      | 10000              | 1000         | <b>£49.56</b>    |
|                    | RNSFHH0550     | 2.5                   | 5.0                   |              |                      |                        |                         | 16.5                       |                          | 10000              | 500          | <b>£54.60</b>    |
| <b>M6</b>          | RNSFHH0630     | 0.5                   | 3.0                   | 9.0          | 8.9                  | 12.7                   | 1.3                     | 15.0                       | 12.0                     | 15000              | 500          | <b>£57.02</b>    |
|                    | RNSFHH0655     | 3.0                   | 5.5                   |              |                      |                        |                         | 19.5                       |                          | 15000              | 500          | <b>£59.41</b>    |
| <b>M8</b>          | RNSFHH0835     | 1.0                   | 3.5                   | 11.0         | 10.9                 | 16.0                   | 1.5                     | 18.0                       | 31.0                     | 27000              | 250          | <b>£102.92</b>   |
|                    | RNSFHH0855     | 3.5                   | 5.5                   |              |                      |                        |                         | 21.0                       |                          | 27000              | 250          | <b>£105.32</b>   |
| <b>M10</b>         | RNSFHH1035     | 1.0                   | 3.5                   | 13.0         | 12.9                 | 18.0                   | 1.7                     | 21.0                       | 42.0                     | 28500              | 250          | <b>£162.33</b>   |
|                    | RNSFHH1060     | 3.5                   | 6.0                   |              |                      |                        |                         | 24.0                       |                          | 28500              | 200          | <b>£166.30</b>   |
| <b>M12</b>         | RNSFHH1250     | 2.0                   | 5.0                   | 16.0         | 15.9                 | 23.0                   | 2.0                     | 27.0                       | 58.0                     | 48000              | 50           | <b>£342.91</b>   |

# REDUCED HEAD FULL HEXAGON BODY OPEN BLIND RIVET NUT

● Steel Zinc&Clr Tri8 (AISI1008)

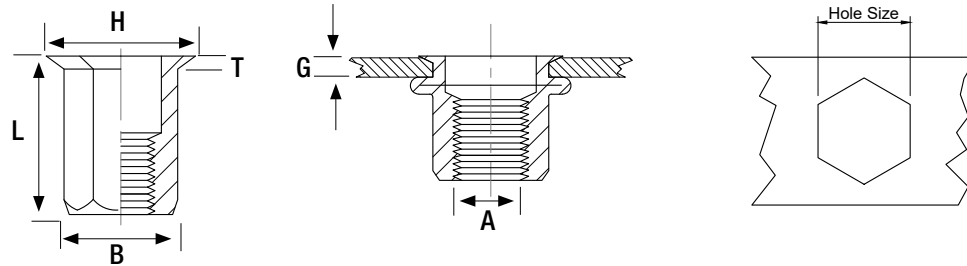

| Thread Size mm (A) | Article Number | Grip Range Min mm (G) | Grip Range Max mm (G) | Hole Size mm | Body Diameter mm (B) | Flange Diameter mm (H) | Flange Thickness mm (T) | Body Overall Length mm (L) | Max Tightening Torque Nm | Tensile Strength N | Box Quantity   | Price £ Per 1000 |
|--------------------|----------------|-----------------------|-----------------------|--------------|----------------------|------------------------|-------------------------|----------------------------|--------------------------|--------------------|----------------|------------------|
| <b>M4</b>          | RNSRHH0425     | 0.5                   | 2.5                   | 6.0          | 5.9                  | 7.0                    | 0.5                     | 11.0                       | 4.0                      | 6800               | 1500           | <b>£46.20</b>    |
| <b>M5</b>          | RNSRHH0530     | 0.5                   | 3.0                   | 7.0          | 6.9                  | 8.0                    |                         | 14.5                       | 6.5                      | 10000              | 1000           | <b>£49.56</b>    |
|                    | RNSRHH0550     | 3.0                   | 5.0                   |              |                      |                        | 500                     | <b>£54.60</b>              |                          |                    |                |                  |
| <b>M6</b>          | RNSRHH0635     | 1.0                   | 3.5                   | 9.0          | 8.9                  | 10.0                   | 0.6                     | 16.0                       | 12.0                     | 15000              | 500            | <b>£57.02</b>    |
|                    | RNSRHH0660     | 3.0                   | 6.0                   |              |                      |                        |                         | 500                        |                          |                    | <b>£74.59</b>  |                  |
| <b>M8</b>          | RNSRHH0840     | 1.0                   | 4.0                   | 11.0         | 10.9                 | 12.0                   | 0.7                     | 18.0                       | 31.0                     | 27000              | 250            | <b>£102.92</b>   |
|                    | RNSRHH0860     | 4.0                   | 6.0                   |              |                      |                        |                         | 250                        |                          |                    | <b>£105.32</b> |                  |
| <b>M10</b>         | RNSRHH1035     | 1.0                   | 3.5                   | 13.0         | 12.9                 | 14.5                   | 0.8                     | 19.0                       | 42.0                     | 28500              | 250            | <b>£162.33</b>   |
|                    | RNSRHH1060     | 3.5                   | 6.0                   |              |                      |                        |                         | 250                        |                          |                    | <b>£166.30</b> |                  |
| <b>M12</b>         | RNSRHH1240     | 1.0                   | 4.0                   | 16.0         | 15.9                 | 17.5                   | 1.0                     | 25.0                       | 58.0                     | 48000              | 100            | <b>£342.91</b>   |

*Grip range and test data are guide figures only*



# FLAT HEAD PART HEXAGON BODY OPEN BLIND RIVET NUT

Steel Zinc&Clr Tri8 (AISI1008)

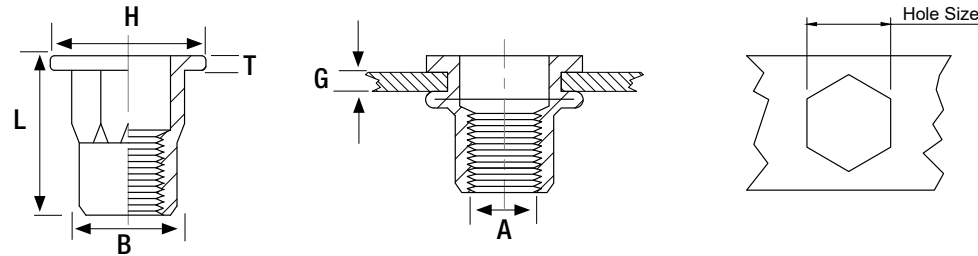

| Thread Size mm (A) | Article Number | Grip Range Min mm (G) | Grip Range Max mm (G) | Hole Size mm | Body Diameter mm (B) | Flange Diameter mm (H) | Flange Thickness mm (T) | Body Overall Length mm (L) | Max Tightening Torque Nm | Tensile Strength N | Box Quantity | Price £ Per 1000 |
|--------------------|----------------|-----------------------|-----------------------|--------------|----------------------|------------------------|-------------------------|----------------------------|--------------------------|--------------------|--------------|------------------|
| <b>M4</b>          | RNSFHPPH0420   | 0.5                   | 2.0                   | 6.0          | 5.9                  | 9.0                    | 0.8                     | 11.0                       | 4.0                      | 6800               | 1000         | <b>£47.78</b>    |
| <b>M5</b>          | RNSFHPPH0525   | 0.5                   | 2.5                   | 7.0          | 6.9                  | 10.0                   | 1.0                     | 13.0                       | 6.5                      | 10000              | 1000         | <b>£50.05</b>    |
| <b>M6</b>          | RNSFHPPH0630   | 0.5                   | 3.0                   | 9.0          | 8.9                  | 12.5                   | 1.4                     | 15.5                       | 12.0                     | 15000              | 500          | <b>£53.78</b>    |
| <b>M8</b>          | RNSFHPPH0835   | 1.0                   | 3.5                   | 11.0         | 10.9                 | 16.0                   | 1.5                     | 18.0                       | 31.0                     | 27000              | 250          | <b>£97.09</b>    |
| <b>M10</b>         | RNSFHPPH1035   | 1.0                   | 3.5                   | 13.0         | 12.9                 | 18.0                   | 1.7                     | 21.0                       | 42.0                     | 28500              | 250          | <b>£153.14</b>   |

# REDUCED HEAD PART HEXAGON BODY OPEN BLIND RIVET NUT

Steel Zinc&Clr Tri8 (AISI1008)

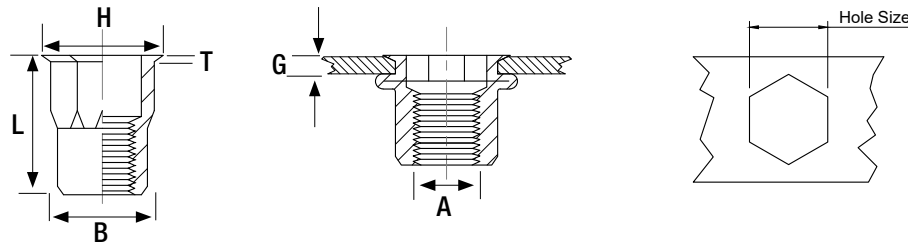

| Thread Size mm (A) | Article Number | Grip Range Min mm (G) | Grip Range Max mm (G) | Hole Size mm | Body Diameter mm (B) | Flange Diameter mm (H) | Flange Thickness mm (T) | Body Overall Length mm (L) | Max Tightening Torque Nm | Tensile Strength N | Box Quantity | Price £ Per 1000 |
|--------------------|----------------|-----------------------|-----------------------|--------------|----------------------|------------------------|-------------------------|----------------------------|--------------------------|--------------------|--------------|------------------|
| <b>M4</b>          | RNSRHPH0420    | 0.5                   | 2.0                   | 6.0          | 5.9                  | 7.0                    | 0.5                     | 12.0                       | 4.0                      | 6800               | 1000         | <b>£47.78</b>    |
| <b>M5</b>          | RNSRHPH0525    | 0.5                   | 2.5                   | 7.0          | 6.9                  | 8.0                    | 0.5                     | 13.0                       | 6.5                      | 10000              | 1000         | <b>£50.05</b>    |
| <b>M6</b>          | RNSRHPH0635    | 1.0                   | 3.5                   | 9.0          | 8.9                  | 10.0                   | 0.6                     | 16.0                       | 12.0                     | 15000              | 500          | <b>£53.78</b>    |
| <b>M8</b>          | RNSRHPH0835    | 1.0                   | 3.5                   | 11.0         | 10.9                 | 12.0                   | 0.7                     | 17.5                       | 31.0                     | 27000              | 250          | <b>£97.09</b>    |
| <b>M10</b>         | RNSRHPH1040    | 1.0                   | 4.0                   | 13.0         | 12.9                 | 14.5                   | 0.8                     | 21.0                       | 42.0                     | 28500              | 250          | <b>£153.14</b>   |

Grip range and test data are guide figures only



# FLAT HEAD ROUND KNURLED BODY CLOSED BLIND RIVET NUT

Steel Zinc&Clr Tri8 (AISI1008)

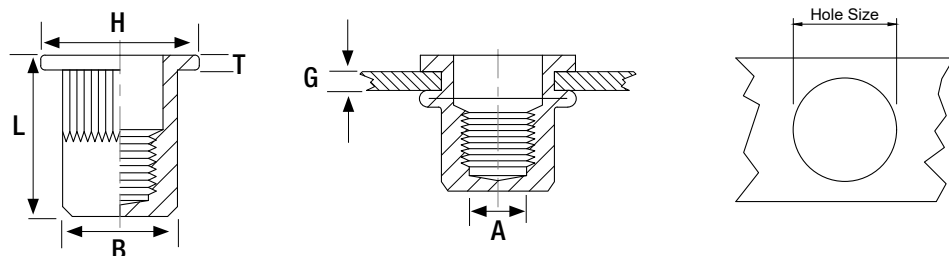

| Thread Size mm (A) | Article Number | Grip Range Min mm (G) | Grip Range Max mm (G) | Hole Size mm | Body Diameter mm (B) | Flange Diameter mm (H) | Flange Thickness mm (T) | Body Overall Length mm (L) | Max Tightening Torque Nm | Tensile Strength N | Box Quantity | Price £ Per 1000 |
|--------------------|----------------|-----------------------|-----------------------|--------------|----------------------|------------------------|-------------------------|----------------------------|--------------------------|--------------------|--------------|------------------|
| <b>M3</b>          | RNSFHC0315     | 0.5                   | 1.5                   | 5.0          | 4.9                  | 8.0                    | 0.8                     | 15.0                       | 1.0                      | 3900               | 1000         | £89.40           |
|                    | RNSFHC0335     | 2.0                   | 3.5                   |              |                      |                        |                         | 16.0                       |                          |                    | 1000         | £95.50           |
| <b>M4</b>          | RNSFHC0420     | 0.5                   | 2.0                   | 6.0          | 5.9                  | 9.0                    | 0.8                     | 16.0                       | 3.0                      | 6800               | 1000         | £89.40           |
|                    | RNSFHC0440     | 2.0                   | 4.0                   |              |                      |                        |                         | 18.0                       |                          |                    | 500          | £97.75           |
| <b>M5</b>          | RNSFHC0530     | 0.5                   | 3.0                   | 7.0          | 6.9                  | 10.0                   | 1.0                     | 17.0                       | 6.0                      | 10000              | 500          | £102.79          |
|                    | RNSFHC0550     | 2.5                   | 5.0                   |              |                      |                        |                         | 19.0                       |                          |                    | 300          | £105.97          |
| <b>M6</b>          | RNSFHC0630     | 0.5                   | 3.0                   | 9.0          | 8.9                  | 12.3                   | 1.3                     | 19.2                       | 10.0                     | 15000              | 300          | £115.51          |
|                    | RNSFHC0650     | 3.0                   | 5.0                   |              |                      |                        |                         | 21.0                       |                          |                    | 200          | £126.23          |
| <b>M8</b>          | RNSFHC0830     | 0.5                   | 3.0                   | 11.0         | 10.9                 | 15.0                   | 1.5                     | 21.5                       | 24.0                     | 27000              | 250          | £162.33          |
|                    | RNSFHC0855     | 3.0                   | 5.5                   |              |                      |                        |                         | 24.0                       |                          |                    | 250          | £174.21          |
| <b>M10</b>         | RNSFHC1040     | 1.0                   | 4.0                   | 13.0         | 12.9                 | 17.0                   | 1.6                     | 27.0                       | 32.0                     | 28500              | 200          | £286.68          |
|                    | RNSFHC1060     | 3.5                   | 6.0                   |              |                      |                        |                         | 32.5                       |                          |                    | 200          | £289.03          |

# COUNTERSUNK HEAD ROUND KNURLED BODY CLOSED BLIND RIVET NUT

Steel Zinc&Clr Tri8 (AISI1008)

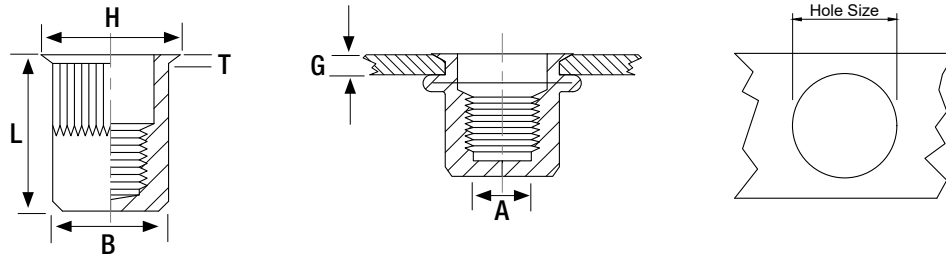

| Thread Size mm (A) | Article Number | Grip Range Min mm (G) | Grip Range Max mm (G) | Hole Size mm | Body Diameter mm (B) | Flange Diameter mm (H) | Flange Thickness mm (T) | Body Overall Length mm (L) | Max Tightening Torque Nm | Tensile Strength N | Box Quantity | Price £ Per 1000 |
|--------------------|----------------|-----------------------|-----------------------|--------------|----------------------|------------------------|-------------------------|----------------------------|--------------------------|--------------------|--------------|------------------|
| <b>M3</b>          | RNSCHC0325     | 1.5                   | 2.5                   | 5.0          | 4.9                  | 7.5                    | 1.5                     | 15.5                       | 1.0                      | 3900               | 1000         | £89.40           |
|                    | RNSCHC0340     | 2.5                   | 4.0                   |              |                      |                        |                         | 17.5                       |                          |                    | 1000         | £95.50           |
| <b>M4</b>          | RNSCHC0430     | 1.5                   | 3.0                   | 6.0          | 5.9                  | 9.0                    |                         | 17.5                       | 3.0                      | 6800               | 1000         | £89.40           |
|                    | RNSCHC0450     | 3.0                   | 5.0                   |              |                      |                        |                         | 19.5                       |                          |                    | 500          | £97.75           |
| <b>M5</b>          | RNSCHC0535     | 1.5                   | 3.5                   | 7.0          | 6.9                  | 10.0                   |                         | 19.5                       | 6.0                      | 10000              | 500          | £102.79          |
|                    | RNSCHC0550     | 3.5                   | 5.0                   |              |                      |                        |                         | 23.5                       |                          |                    | 300          | £105.97          |
| <b>M6</b>          | RNSCHC0640     | 1.5                   | 4.0                   | 9.0          | 8.9                  | 12.0                   |                         | 23.5                       | 10.0                     | 15000              | 300          | £115.51          |
|                    | RNSCHC0660     | 4.0                   | 6.0                   |              |                      |                        |                         | 25.5                       |                          |                    | 200          | £126.23          |
| <b>M8</b>          | RNSCHC0845     | 1.5                   | 4.5                   | 11.0         | 10.9                 | 14.0                   |                         | 26.5                       | 24.0                     | 27000              | 250          | £162.33          |
|                    | RNSCHC0860     | 4.5                   | 6.0                   |              |                      |                        |                         | 29.5                       |                          |                    | 250          | £174.21          |
| <b>M10</b>         | RNSCHC1050     | 1.5                   | 5.0                   | 13.0         | 12.9                 | 16.0                   | 30.0                    | 32.0                       | 28500                    | 200                | £286.68      |                  |
|                    | RNSCHC1065     | 4.5                   | 6.5                   |              |                      |                        | 32.5                    |                            |                          | 200                | £289.03      |                  |

Grip range and test data are guide figures only





# REDUCED HEAD ROUND KNURLED BODY CLOSED BLIND RIVET NUT

Steel Zinc&Clr Tri8 (AISI1008)

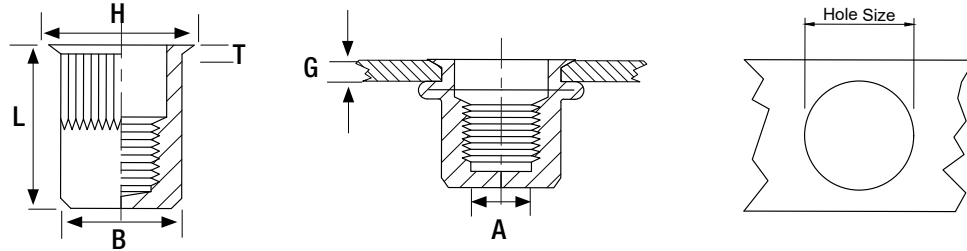

| Thread Size mm (A) | Article Number | Grip Range Min mm (G) | Grip Range Max mm (G) | Hole Size mm | Body Diameter mm (B) | Flange Diameter mm (H) | Flange Thickness mm (T) | Body Overall Length mm (L) | Max Tightening Torque Nm | Tensile Strength N | Box Quantity | Price £ Per 1000 |
|--------------------|----------------|-----------------------|-----------------------|--------------|----------------------|------------------------|-------------------------|----------------------------|--------------------------|--------------------|--------------|------------------|
| <b>M4</b>          | RNSRHC0420     | 0.5                   | 2.0                   | 6.0          | 5.9                  | 7.0                    | 0.5                     | 15.0                       | 3.0                      | 6800               | 1500         | <b>£64.18</b>    |
|                    | RNSRHC0435     | 2.0                   | 3.5                   |              |                      |                        |                         | 16.5                       |                          |                    | 1500         | <b>£72.32</b>    |
| <b>M5</b>          | RNSRHC0520     | 0.5                   | 2.0                   | 7.0          | 6.9                  | 8.0                    | 0.5                     | 16.5                       | 6.0                      | 10000              | 1000         | <b>£71.42</b>    |
|                    | RNSRHC0535     | 2.0                   | 3.5                   |              |                      |                        |                         | 18.0                       |                          |                    | 500          | <b>£79.55</b>    |
| <b>M6</b>          | RNSRHC0630     | 0.5                   | 3.0                   | 9.0          | 8.9                  | 10.0                   | 0.6                     | 20.5                       | 10.0                     | 15000              | 500          | <b>£77.74</b>    |
|                    | RNSRHC0645     | 3.0                   | 4.5                   |              |                      |                        |                         | 22.0                       |                          |                    | 400          | <b>£85.88</b>    |
| <b>M8</b>          | RNSRHC0830     | 0.5                   | 3.0                   | 11.0         | 10.9                 | 12.0                   | 0.7                     | 23.0                       | 24.0                     | 27000              | 250          | <b>£103.51</b>   |
|                    | RNSRHC0845     | 3.0                   | 4.5                   |              |                      |                        |                         | 24.5                       |                          |                    | 250          | <b>£111.19</b>   |
| <b>M10</b>         | RNSRHC1035     | 1.0                   | 3.0                   | 13.0         | 12.9                 | 14.0                   | 0.7                     | 24.5                       | 32.0                     | 28500              | 200          | <b>£178.99</b>   |
|                    | RNSRHC1050     | 3.0                   | 5.0                   |              |                      |                        |                         | 26.0                       |                          |                    | 200          | <b>£186.68</b>   |

**NEW**

# REDUCED HEAD PART HEXAGON BODY CLOSED BLIND RIVET NUT

Steel Zinc&Clr Tri8 (AISI1008)

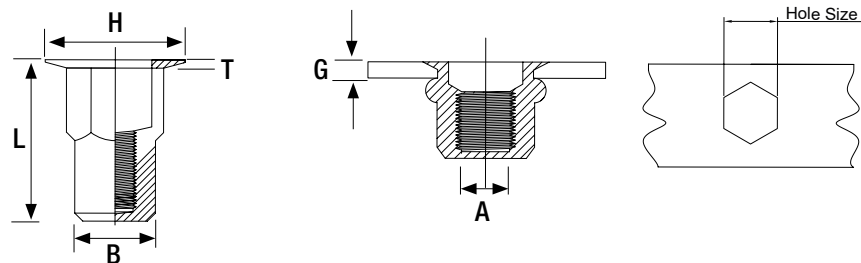

| Thread Size mm (A) | Article Number | Grip Range Min mm (G) | Grip Range Max mm (G) | Hole Size mm | Body Diameter mm (B) | Flange Diameter mm (H) | Flange Thickness mm (T) | Body Overall Length mm (L) | Max Tightening Torque Nm | Tensile Strength N | Box Quantity | Price £ Per 1000 |
|--------------------|----------------|-----------------------|-----------------------|--------------|----------------------|------------------------|-------------------------|----------------------------|--------------------------|--------------------|--------------|------------------|
| M4                 | RNSRHPHC0420   | 0.5                   | 2.0                   | 6.0          | 5.9                  | 7.0                    | 0.5                     | 15.5                       | 4.0                      | 6800               | 1000         | £71.42           |
|                    | RNSRHPHC0440   | 2.0                   | 4.0                   |              |                      |                        |                         | 18.0                       |                          |                    | 1000         | £79.10           |
| M5                 | RNSRHPHC0525   | 0.5                   | 2.5                   | 7.0          | 6.9                  | 8.0                    | 0.5                     | 18.0                       | 6.5                      | 10000              | 1000         | £76.84           |
|                    | RNSRHPHC0545   | 2.5                   | 4.5                   |              |                      |                        |                         | 23.0                       |                          |                    | 1000         | £84.07           |
| M6                 | RNSRHPHC0635   | 1.0                   | 3.5                   | 9.0          | 8.9                  | 10.0                   | 0.6                     | 21.5                       | 12.0                     | 15000              | 500          | £82.72           |
|                    | RNSRHPHC0650   | 3.0                   | 5.0                   |              |                      |                        |                         | 23.5                       |                          |                    | 500          | £90.85           |
| M8                 | RNSRHPHC0835   | 1.0                   | 3.5                   | 11.0         | 10.9                 | 12.0                   | 0.7                     | 24.0                       | 31.0                     | 27000              | 250          | £107.58          |
|                    | RNSRHPHC0855   | 3.5                   | 5.5                   |              |                      |                        |                         | 25.0                       |                          |                    | 250          | £115.26          |
| M10                | RNSRHPHC1040   | 1.0                   | 4.0                   | 13.0         | 12.9                 | 14.5                   | 0.8                     | 30.5                       | 42.0                     | 28500              | 200          | £187.58          |
|                    | RNSRHPHC1060   | 4.0                   | 6.0                   |              |                      |                        |                         | 35.0                       |                          |                    | 200          | £195.72          |

**NEW**

*Grip range and test data are guide figures only*



# FLAT HEAD ROUND JK SPLIT BODY OPEN BLIND RIVET NUT

Steel Zinc&Clr Tri3 (AISI1008)

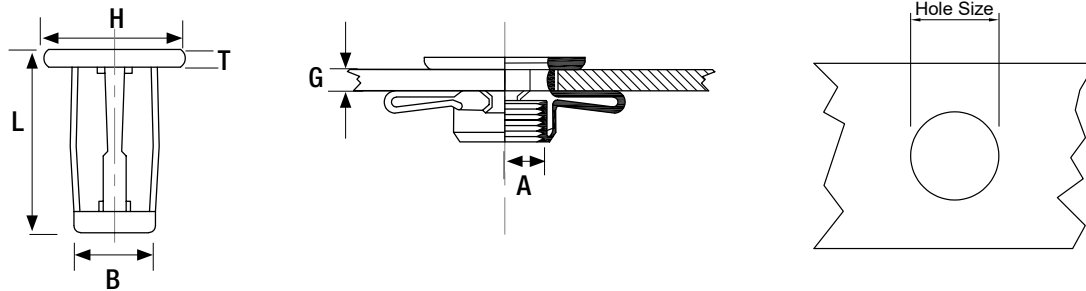

| Thread Size mm (A) | Article Number | Grip Range Min mm (G) | Grip Range Max mm (G) | Hole Size mm | Body Diameter mm (B) | Flange Diameter mm (H) | Flange Thickness mm (T) | Body Overall Length mm (L) | Max Tightening Torque Nm | Tensile Strength N | Box Quantity | Price £ Per 1000 |
|--------------------|----------------|-----------------------|-----------------------|--------------|----------------------|------------------------|-------------------------|----------------------------|--------------------------|--------------------|--------------|------------------|
| <b>M4</b>          | RNSFHJK0450    | 0.1                   | 5.0                   | 8.0          | 7.9                  | 12.2                   | 1.6                     | 16.8                       | 2.0                      | 245                | 500          | <b>£253.16</b>   |
|                    | RNSFHJK04100   | 5.0                   | 10.0                  |              |                      |                        |                         | 22.0                       |                          |                    | 500          | <b>£274.35</b>   |
| <b>M5</b>          | RNSFHJK0550    | 0.1                   | 5.0                   | 10.0         | 9.9                  | 14.0                   | 1.6                     | 18.4                       | 3.0                      | 295                | 250          | <b>£290.78</b>   |
|                    | RNSFHJK05100   | 5.0                   | 10.0                  |              |                      |                        |                         | 23.2                       |                          |                    | 250          | <b>£313.55</b>   |
| <b>M6</b>          | RNSFHJK0650    | 0.1                   | 5.0                   | 12.0         | 11.9                 | 16.0                   | 1.6                     | 18.6                       | 4.2                      | 390                | 250          | <b>£319.63</b>   |
|                    | RNSFHJK06100   | 5.0                   | 10.0                  |              |                      |                        |                         | 22.9                       |                          |                    | 250          | <b>£345.44</b>   |
| <b>M8</b>          | RNSFHJK0850    | 0.1                   | 5.0                   | 15.0         | 14.9                 | 18.2                   | 2.0                     | 21.0                       | 4.2                      | 490                | 100          | <b>£464.38</b>   |
|                    | RNSFHJK08100   | 5.0                   | 10.0                  |              |                      |                        |                         | 25.5                       |                          |                    | 100          | <b>£520.54</b>   |

(\* Please note we do not recommend you use this product in hard materials exceeding 8.0mm or if a high torque load is required.

# NEW

# FLAT HEAD ROUND PN HEAVY DUTY SPLIT BODY OPEN BLIND RIVET NUT

Steel Zinc&Clr Tri8 (AISI1008)

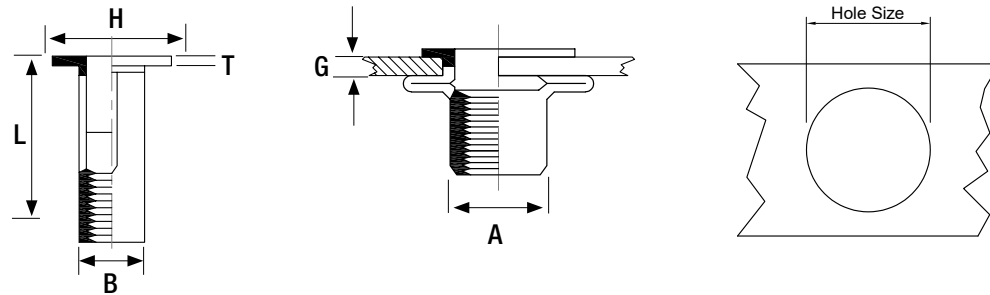

| Thread Size mm (A) | Article Number | Grip Range Min mm (G) | Grip Range Max mm (G) | Hole Size mm | Body Diameter mm (B) | Flange Diameter mm (H) | Flange Thickness mm (T) | Body Overall Length mm (L) | Max Tightening Torque Nm | Tensile Strength N | Box Quantity | Price £ Per 1000 |
|--------------------|----------------|-----------------------|-----------------------|--------------|----------------------|------------------------|-------------------------|----------------------------|--------------------------|--------------------|--------------|------------------|
| <b>M5</b>          | RNSFHPN0545    | 0.5                   | 4.5                   | 7.5          | 7.4                  | 12.7                   | 1.0                     | 22.0                       | 6.5                      | 10000              | 500          | <b>£306.88</b>   |
| <b>M6</b>          | RNSFHPN0670    | 0.5                   | 7.1                   | 8.8          | 8.7                  | 16.0                   | 1.5                     | 27.0                       | 12.0                     | 15000              | 250          | <b>£385.20</b>   |
|                    | RNSFHPN06127   | 7.1                   | 12.7                  |              |                      |                        |                         | 33.0                       |                          |                    | 250          | <b>£469.94</b>   |
| <b>M8</b>          | RNSFHPN0870    | 0.5                   | 7.1                   | 11.1         | 11.0                 | 19.0                   | 1.6                     | 30.5                       | 31.0                     | 27000              | 100          | <b>£559.82</b>   |
|                    | RNSFHPN08127   | 7.1                   | 12.7                  |              |                      |                        |                         | 37.0                       |                          |                    | 100          | <b>£677.52</b>   |
| <b>M10</b>         | RNSFHPN1070    | 0.5                   | 7.1                   | 13.1         | 13.0                 | 22.2                   | 2.2                     | 33.0                       | 42.0                     | 28500              | 100          | <b>£930.04</b>   |

**NEW**

*Grip range and test data are guide figures only*



# FLAT HEAD ROUND US KNURLED BODY OPEN BLIND RIVET NUT

Steel Zinc&Clr Tri8 (AISI1008)

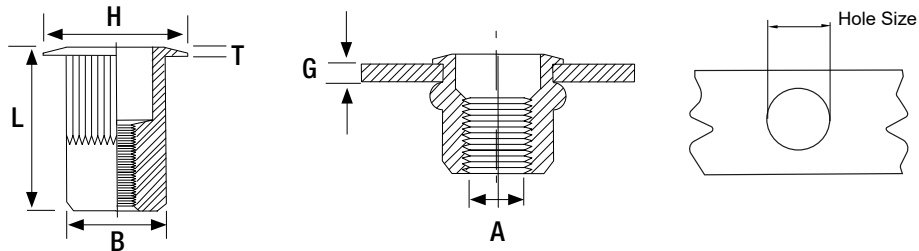

| Thread Size mm (A) | Article Number | Grip Range Min mm (G) | Grip Range Max mm (G) | Hole Size mm | Body Diameter mm (B) | Flange Diameter mm (H) | Flange Thickness mm (T) | Body Overall Length mm (L) | Max Tightening Torque Nm | Tensile Strength N | Box Quantity | Price £ Per 1000 |
|--------------------|----------------|-----------------------|-----------------------|--------------|----------------------|------------------------|-------------------------|----------------------------|--------------------------|--------------------|--------------|------------------|
| <b>M4</b>          | RNSFHUS0420    | 0.5                   | 2.0                   | 6.75         | 6.7                  | 9.9                    | 0.75                    | 10.7                       | 3.0                      | 6000               | 1000         | <b>£37.52</b>    |
|                    | RNSFHUS0433    | 2.0                   | 3.3                   |              |                      |                        |                         | 11.9                       |                          |                    | 1000         | <b>£45.20</b>    |
| <b>M5</b>          | RNSFHUS0533    | 0.5                   | 3.3                   | 7.6          | 7.5                  | 10.5                   | 0.75                    | 12.0                       | 6.0                      | 10000              | 1000         | <b>£39.32</b>    |
|                    | RNSFHUS0557    | 3.3                   | 5.7                   |              |                      |                        |                         | 14.9                       |                          |                    | 1000         | <b>£46.10</b>    |
| <b>M6</b>          | RNSFHUS0642    | 0.7                   | 4.2                   | 10.0         | 9.9                  | 12.7                   | 0.75                    | 14.7                       | 10.0                     | 15000              | 500          | <b>£47.91</b>    |
|                    | RNSFHUS0666    | 4.2                   | 6.6                   |              |                      |                        |                         | 17.3                       |                          |                    | 500          | <b>£55.14</b>    |
| <b>M8</b>          | RNSFHUS0838    | 0.7                   | 3.8                   | 13.5         | 13.4                 | 17.4                   | 0.9                     | 17.5                       | 24.0                     | 27000              | 250          | <b>£97.18</b>    |
|                    | RNSFHUS0879    | 3.8                   | 7.9                   |              |                      |                        |                         | 20.5                       |                          |                    | 250          | <b>£104.41</b>   |
| <b>M10</b>         | RNSFHUS1038    | 0.7                   | 3.8                   | 13.5         | 13.4                 | 17.4                   | 0.9                     | 17.5                       | 32.0                     | 28500              | 200          | <b>£109.38</b>   |
|                    | RNSFHUS1079    | 3.8                   | 7.9                   |              |                      |                        |                         | 20.5                       |                          |                    | 200          | <b>£117.52</b>   |

**NEW**

# REDUCED HEAD ROUND US KNURLED BODY OPEN BLIND RIVET NUT

Steel Zinc&Clr Tri8 (AISI1008)

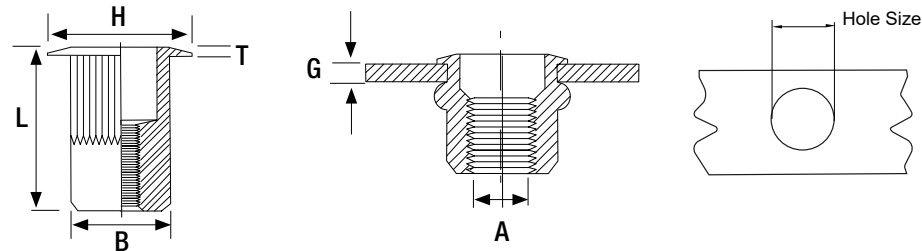

| Thread Size mm (A) | Article Number | Grip Range Min mm (G) | Grip Range Max mm (G) | Hole Size mm | Body Diameter mm (B) | Flange Diameter mm (H) | Flange Thickness mm (T) | Body Overall Length mm (L) | Max Tightening Torque Nm | Tensile Strength N | Box Quantity | Price £ Per 1000 |
|--------------------|----------------|-----------------------|-----------------------|--------------|----------------------|------------------------|-------------------------|----------------------------|--------------------------|--------------------|--------------|------------------|
| M4                 | RNSRHUS0420    | 0.5                   | 2.0                   | 6.75         | 6.7                  | 7.9                    | 0.5                     | 10.7                       | 3.0                      | 6000               | 1000         | £35.26           |
|                    | RNSRHUS0433    | 2.0                   | 3.3                   |              |                      |                        |                         | 11.9                       |                          |                    | 1000         | £42.94           |
| M5                 | RNSRHUS0533    | 0.5                   | 3.3                   | 7.6          | 7.5                  | 8.7                    | 0.5                     | 12.0                       | 6.0                      | 10000              | 1000         | £37.06           |
|                    | RNSRHUS0557    | 3.3                   | 5.7                   |              |                      |                        |                         | 14.9                       |                          |                    | 1000         | £44.75           |
| M6                 | RNSRHUS0642    | 0.7                   | 4.2                   | 10.0         | 9.9                  | 11.6                   | 0.6                     | 14.7                       | 10.0                     | 15000              | 500          | £45.20           |
|                    | RNSRHUS0666    | 4.2                   | 6.6                   |              |                      |                        |                         | 17.3                       |                          |                    | 500          | £52.88           |
| M8                 | RNSRHUS0838    | 0.7                   | 3.8                   | 13.5         | 13.4                 | 15.1                   | 0.6                     | 17.5                       | 24.0                     | 27000              | 250          | £94.92           |
|                    | RNSRHUS0879    | 3.8                   | 7.9                   |              |                      |                        |                         | 20.5                       |                          |                    | 250          | £102.15          |
| M10                | RNSRHUS1038    | 0.7                   | 3.8                   | 13.5         | 13.4                 | 15.1                   | 0.6                     | 17.5                       | 32.0                     | 28500              | 200          | £106.67          |
|                    | RNSRHUS1079    | 3.8                   | 7.9                   |              |                      |                        |                         | 20.5                       |                          |                    | 200          | £114.81          |

**NEW**

Grip range and test data are guide figures only



# FLAT HEAD ROUND KNURLED BODY OPEN BLIND RIVET NUT

A2 Stainless Steel (AISI304)

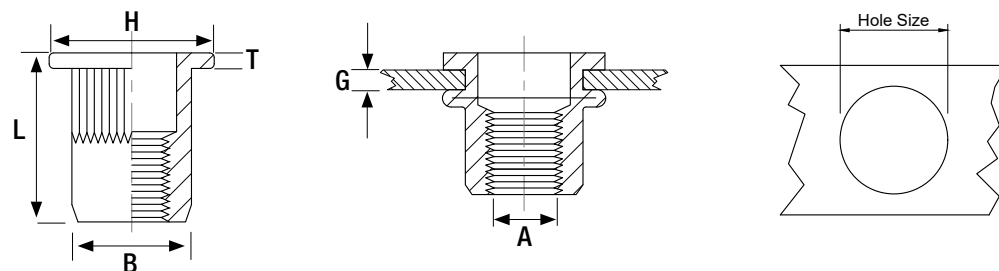

| Thread Size mm (A) | Article Number | Grip Range Min mm (G) | Grip Range Max mm (G) | Hole Size mm | Body Diameter mm (B) | Flange Diameter mm (H) | Flange Thickness mm (T) | Body Overall Length mm (L) | Max Tightening Torque Nm | Tensile Strength N | Box Quantity | Price £ Per 1000 |
|--------------------|----------------|-----------------------|-----------------------|--------------|----------------------|------------------------|-------------------------|----------------------------|--------------------------|--------------------|--------------|------------------|
| <b>M3</b>          | RNSSFH0320     | 0.5                   | 1.5                   | 5.0          | 4.9                  | 7.0                    | 0.8                     | 9.0                        | 1.0                      | 3900               | 2000         | £193.82          |
| <b>M4</b>          | RNSSFH0420     | 0.5                   | 2.0                   | 6.0          | 5.9                  | 9.0                    |                         | 10.5                       | 3.0                      | 6800               | 1000         | £193.82          |
|                    | RNSSFH0440     | 2.0                   | 4.0                   |              |                      |                        | 12.0                    | 1000                       |                          |                    | £228.72      |                  |
| <b>M5</b>          | RNSSFH0525     | 0.5                   | 2.5                   | 7.0          | 6.9                  | 10.0                   | 1.0                     | 13.0                       | 6.0                      | 10000              | 1000         | £201.57          |
|                    | RNSSFH0545     | 2.0                   | 4.0                   |              |                      |                        |                         | 15.0                       |                          |                    | 500          | £248.05          |
|                    | RNSSFH0580     | 5.5                   | 8.0                   |              |                      |                        |                         | 19.0                       |                          |                    | 500          | £262.54          |
| <b>M6</b>          | RNSSFH0630     | 0.5                   | 3.0                   | 9.0          | 8.9                  | 12.5                   | 1.5                     | 15.0                       | 10.0                     | 15000              | 500          | £227.13          |
|                    | RNSSFH0650     | 3.0                   | 5.0                   |              |                      |                        |                         | 19.5                       |                          |                    | 500          | £261.27          |
|                    | RNSSFH0680     | 5.5                   | 8.0                   |              |                      |                        |                         | 21.0                       |                          |                    | 300          | £297.39          |
| <b>M8</b>          | RNSSFH0835     | 1.0                   | 3.5                   | 11.0         | 10.9                 | 15.0                   | 1.8                     | 18.5                       | 24.0                     | 27000              | 250          | £335.81          |
|                    | RNSSFH0860     | 3.5                   | 5.5                   |              |                      |                        |                         | 21.5                       |                          |                    | 250          | £387.65          |
|                    | RNSSFH0880     | 5.0                   | 8.0                   |              |                      |                        |                         | 23.5                       |                          |                    | 200          | £427.74          |
| <b>M10</b>         | RNSSFH1035     | 1.0                   | 4.0                   | 13.0         | 12.9                 | 17.0                   | 1.8                     | 21.0                       | 32.0                     | 28500              | 250          | £638.04          |
|                    | RNSSFH1055     | 4.0                   | 6.0                   |              |                      |                        |                         | 24.0                       |                          |                    | 250          | £697.74          |
| <b>M12</b>         | RNSSFH1240     | 1.0                   | 4.0                   | 16.0         | 15.9                 | 22.0                   | 2.0                     | 25.0                       | 44.0                     | 48000              | 100          | £918.21          |

# COUNTERSUNK HEAD ROUND KNURLED BODY OPEN BLIND RIVET NUT

 A2 Stainless Steel (AISI304)

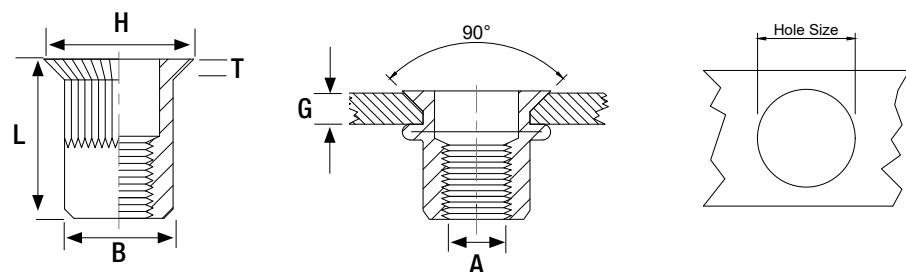

| Thread Size mm (A) | Article Number | Grip Range Min mm (G) | Grip Range Max mm (G) | Hole Size mm | Body Diameter mm (B) | Flange Diameter mm (H) | Flange Thickness mm (T) | Body Overall Length mm (L) | Max Tightening Torque Nm | Tensile Strength N | Box Quantity | Price £ Per 1000 |
|--------------------|----------------|-----------------------|-----------------------|--------------|----------------------|------------------------|-------------------------|----------------------------|--------------------------|--------------------|--------------|------------------|
| <b>M3</b>          | RNSSCH0330     | 1.6                   | 3.0                   | 5.0          | 4.9                  | 7.5                    | 1.5                     | 8.5                        | 1.0                      | 3900               | 2000         | £194.50          |
| <b>M4</b>          | RNSSCH0435     | 1.5                   | 3.0                   | 6.0          | 5.9                  | 9.0                    |                         | 12.0                       | 3.0                      | 6800               | 1000         | £193.82          |
|                    | RNSSCH0450     | 3.0                   | 4.5                   |              |                      |                        |                         | 13.0                       |                          |                    |              | £218.90          |
| <b>M5</b>          | RNSSCH0535     | 1.5                   | 3.5                   | 7.0          | 6.9                  | 10.0                   |                         | 13.0                       | 6.0                      | 10000              | 500          | £201.57          |
|                    | RNSSCH0550     | 3.5                   | 5.0                   |              |                      |                        |                         | 15.0                       |                          |                    |              | £237.88          |
| <b>M6</b>          | RNSSCH0640     | 1.5                   | 4.0                   | 9.0          | 8.9                  | 12.0                   |                         | 15.5                       | 10.0                     | 15000              | 500          | £227.13          |
|                    | RNSSCH0660     | 4.0                   | 6.0                   |              |                      |                        |                         | 17.0                       |                          |                    |              | £270.53          |
| <b>M8</b>          | RNSSCH0845     | 2.0                   | 4.5                   | 11.0         | 10.9                 | 14.0                   |                         | 18.5                       | 24.0                     | 27000              | 250          | £348.87          |
|                    | RNSSCH0860     | 4.5                   | 6.0                   |              |                      |                        |                         | 19.0                       |                          |                    |              | £393.43          |
| <b>M10</b>         | RNSSCH1045     | 2.0                   | 5.0                   | 13.0         | 12.9                 | 16.0                   |                         | 1.7                        | 21.0                     | 32.0               | 28500        | 250              |
|                    | RNSSCH1060     | 5.0                   | 6.5                   |              |                      |                        | 24.0                    | £724.45                    |                          |                    |              |                  |
| <b>M12</b>         | RNSSCH1250     | 1.7                   | 5.0                   | 16.0         | 15.9                 | 18.0                   | 1.8                     | 24.0                       | 44.0                     | 48000              | 100          | £918.21          |
|                    | RNSSCH1275     | 4.5                   | 7.5                   |              |                      |                        | 27.5                    | £942.26                    |                          |                    |              |                  |

*Grip range and test data are guide figures only*



# REDUCED HEAD ROUND KNURLED BODY OPEN BLIND RIVET NUT

 A2 Stainless Steel (AISI304)

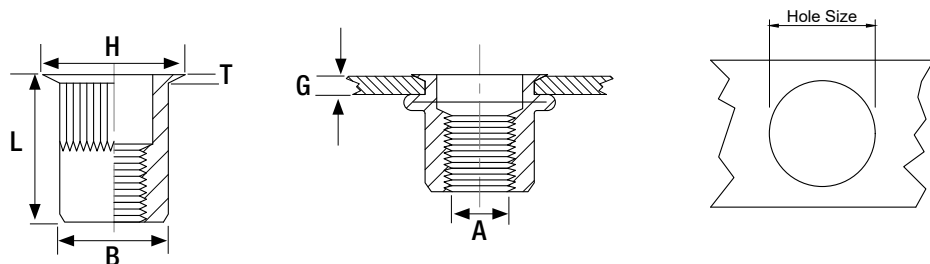

| Thread Size mm (A) | Article Number | Grip Range Min mm (G) | Grip Range Max mm (G) | Hole Size mm | Body Diameter mm (B) | Flange Diameter mm (H) | Flange Thickness mm (T) | Body Overall Length mm (L) | Max Tightening Torque Nm | Tensile Strength N | Box Quantity | Price £ Per 1000 |
|--------------------|----------------|-----------------------|-----------------------|--------------|----------------------|------------------------|-------------------------|----------------------------|--------------------------|--------------------|--------------|------------------|
| <b>M3</b>          | RNSSRH0325     | 1.5                   | 2.5                   | 5.0          | 4.9                  | 5.5                    | 0.4                     | 11.5                       | 1.0                      | 3900               | 2000         | <b>£166.13</b>   |
| <b>M4</b>          | RNSSRH0420     | 0.5                   | 2.0                   | 6.0          | 5.9                  | 7.0                    | 0.5                     | 10.5                       | 3.0                      | 6800               | 1000         | <b>£166.13</b>   |
|                    | RNSSRH0440     | 2.0                   | 4.0                   |              |                      |                        |                         | 13.0                       |                          |                    | 1000         | <b>£196.05</b>   |
| <b>M5</b>          | RNSSRH0520     | 0.5                   | 2.0                   | 7.0          | 6.9                  | 8.0                    | 0.6                     | 11.5                       | 6.0                      | 10000              | 1000         | <b>£172.78</b>   |
|                    | RNSSRH0540     | 2.0                   | 4.0                   |              |                      |                        |                         | 13.0                       |                          |                    | 1000         | <b>£212.62</b>   |
| <b>M6</b>          | RNSSRH0630     | 0.5                   | 2.5                   | 9.0          | 8.9                  | 10.0                   | 0.6                     | 14.0                       | 10.0                     | 15000              | 500          | <b>£194.69</b>   |
|                    | RNSSRH0650     | 2.5                   | 5.0                   |              |                      |                        |                         | 16.0                       |                          |                    | 500          | <b>£223.95</b>   |
| <b>M8</b>          | RNSSRH0835     | 0.5                   | 3.0                   | 11.0         | 10.9                 | 12.3                   | 0.6                     | 16.5                       | 24.0                     | 27000              | 250          | <b>£299.03</b>   |
|                    | RNSSRH0850     | 3.0                   | 5.0                   |              |                      |                        |                         | 19.5                       |                          |                    | 250          | <b>£313.46</b>   |
| <b>M10</b>         | RNSSRH1035     | 1.0                   | 3.5                   | 13.0         | 12.9                 | 14.5                   | 0.9                     | 17.7                       | 32.0                     | 28500              | 250          | <b>£557.06</b>   |
|                    | RNSSRH1060     | 3.5                   | 6.0                   |              |                      |                        |                         | 23.0                       |                          |                    | 250          | <b>£508.96</b>   |
| <b>M12</b>         | RNSSRH1235     | 1.0                   | 4.0                   | 16.0         | 15.9                 | 16.5                   | 0.9                     | 24.2                       | 44.0                     | 48000              | 100          | <b>£918.20</b>   |
|                    | RNSSRH1260     | 4.0                   | 6.5                   |              |                      |                        |                         | 27.0                       |                          |                    | 100          | <b>£807.64</b>   |

# FLAT HEAD PART HEXAGON BODY OPEN BLIND RIVET NUT

● A2 Stainless Steel (AISI304)

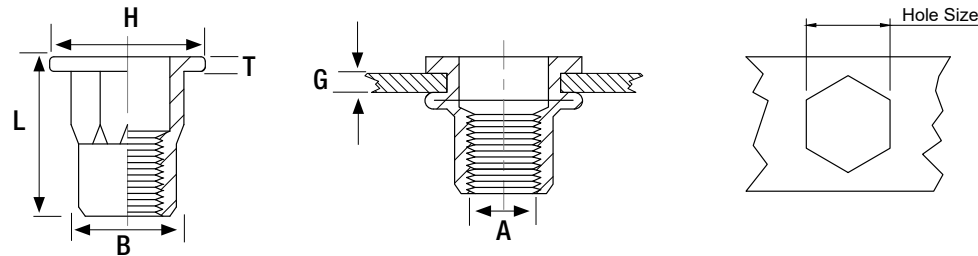

| Thread Size mm (A) | Article Number | Grip Range Min mm (G) | Grip Range Max mm (G) | Hole Size mm | Body Diameter mm (B) | Flange Diameter mm (H) | Flange Thickness mm (T) | Body Overall Length mm (L) | Max Tightening Torque Nm | Tensile Strength N | Box Quantity | Price £ Per 1000 |
|--------------------|----------------|-----------------------|-----------------------|--------------|----------------------|------------------------|-------------------------|----------------------------|--------------------------|--------------------|--------------|------------------|
| <b>M4</b>          | RNSSFHPH0425   | 0.5                   | 2.0                   | 6.0          | 5.9                  | 9.0                    | 0.8                     | 11.0                       | 4.0                      | 6800               | 1000         | <b>£199.65</b>   |
| <b>M5</b>          | RNSSFHPH0535   | 0.5                   | 2.5                   | 7.0          | 6.9                  | 10.0                   | 1.0                     | 12.0                       | 6.5                      | 10000              | 1000         | <b>£212.12</b>   |
| <b>M6</b>          | RNSSFHPH0635   | 0.5                   | 3.0                   | 9.0          | 8.9                  | 12.7                   | 1.5                     | 15.5                       | 12.0                     | 15000              | 500          | <b>£234.01</b>   |
| <b>M8</b>          | RNSSFHPH0835   | 1.0                   | 3.5                   | 11.0         | 10.9                 | 15.0                   | 1.5                     | 18.0                       | 31.0                     | 27000              | 250          | <b>£365.71</b>   |
| <b>M10</b>         | RNSSFHPH1040   | 1.0                   | 4.0                   | 13.0         | 12.9                 | 17.0                   | 1.8                     | 21.0                       | 42.0                     | 28500              | 250          | <b>£636.29</b>   |

*Grip range and test data are guide figures only*

# REDUCED HEAD PART HEXAGON BODY OPEN BLIND RIVET NUT

A2 Stainless Steel (AISI304)

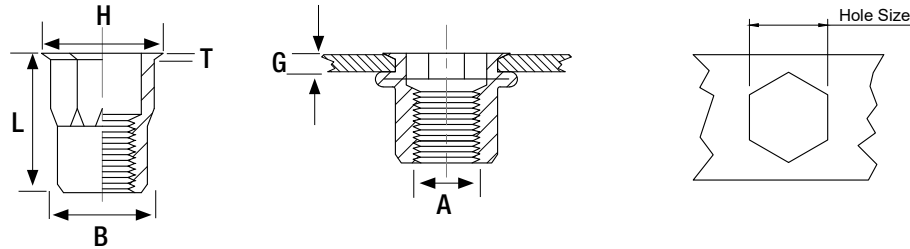

| Thread Size mm (A) | Article Number | Grip Range Min mm (G) | Grip Range Max mm (G) | Hole Size mm | Body Diameter mm (B) | Flange Diameter mm (H) | Flange Thickness mm (T) | Body Overall Length mm (L) | Max Tightening Torque Nm | Tensile Strength N | Box Quantity | Price £ Per 1000 |
|--------------------|----------------|-----------------------|-----------------------|--------------|----------------------|------------------------|-------------------------|----------------------------|--------------------------|--------------------|--------------|------------------|
| <b>M4</b>          | RNSSRHPH0425   | 0.5                   | 2.0                   | 6.0          | 5.9                  | 7.0                    | 0.5                     | 12.0                       | 4.0                      | 6800               | 1000         | £199.65          |
| <b>M5</b>          | RNSSRHPH0525   | 0.5                   | 2.5                   | 7.0          | 6.9                  | 8.0                    | 0.6                     | 13.0                       | 6.5                      | 10000              | 1000         | £212.12          |
| <b>M6</b>          | RNSSRHPH0630   | 1.0                   | 3.0                   | 9.0          | 8.9                  | 10.0                   | 0.6                     | 16.0                       | 12.0                     | 15000              | 500          | £234.01          |
| <b>M8</b>          | RNSSRHPH0835   | 1.0                   | 3.5                   | 11.0         | 10.9                 | 12.5                   | 0.6                     | 17.5                       | 31.0                     | 27000              | 250          | £365.71          |
| <b>M10</b>         | RNSSRHPH1035   | 1.0                   | 4.0                   | 13.0         | 12.9                 | 14.3                   | 0.9                     | 21.0                       | 42.0                     | 28500              | 250          | £636.29          |

# FLAT HEAD ROUND KNURLED BODY CLOSED BLIND RIVET NUT

A2 Stainless Steel (AISI304)

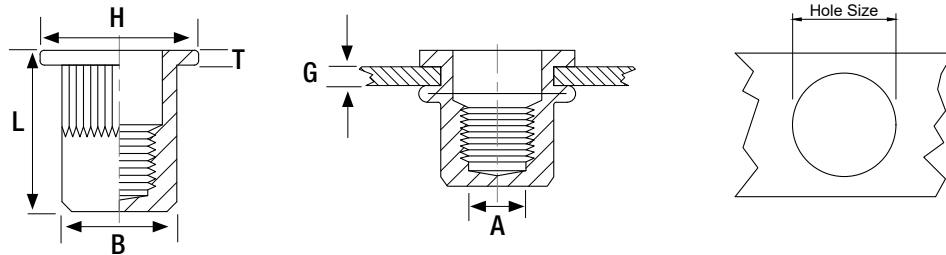

| Thread Size mm (A) | Article Number | Grip Range Min mm (G) | Grip Range Max mm (G) | Hole Size mm | Body Diameter mm (B) | Flange Diameter mm (H) | Flange Thickness mm (T) | Body Overall Length mm (L) | Max Tightening Torque Nm | Tensile Strength N | Box Quantity | Price £ Per 1000 |
|--------------------|----------------|-----------------------|-----------------------|--------------|----------------------|------------------------|-------------------------|----------------------------|--------------------------|--------------------|--------------|------------------|
| <b>M3</b>          | RNSSFHC0320    | 0.5                   | 1.5                   | 5.0          | 4.9                  | 7.0                    | 0.8                     | 13.0                       | 1.2                      | 4000               | 2000         | £387.65          |
| <b>M4</b>          | RNSSFHC0420    | 0.5                   | 2.0                   | 6.0          | 5.9                  | 9.0                    |                         | 16.0                       | 3.0                      | 6800               | 1000         | £387.65          |
|                    | RNSSFHC0440    | 2.0                   | 4.0                   |              |                      |                        | 18.0                    | 1000                       |                          |                    |              | £410.85          |
| <b>M5</b>          | RNSSFHC0525    | 0.5                   | 2.5                   | 7.0          | 6.9                  | 10.0                   | 1.0                     | 17.0                       | 6.0                      | 10000              | 500          | £403.10          |
|                    | RNSSFHC0540    | 2.0                   | 4.0                   |              |                      |                        |                         | 19.0                       |                          |                    | 500          | £409.55          |
| <b>M6</b>          | RNSSFHC0630    | 0.5                   | 3.0                   | 9.0          | 8.9                  | 12.5                   | 1.5                     | 19.2                       | 10.0                     | 15000              | 500          | £469.02          |
|                    | RNSSFHC0655    | 3.0                   | 5.0                   |              |                      |                        |                         | 21.0                       |                          |                    | 500          | £500.04          |
| <b>M8</b>          | RNSSFHC0835    | 1.0                   | 3.5                   | 11.0         | 10.9                 | 15.0                   | 1.5                     | 21.5                       | 24.0                     | 27000              | 250          | £668.24          |
|                    | RNSSFHC0860    | 3.5                   | 5.5                   |              |                      |                        |                         | 24.0                       |                          |                    | 250          | £697.74          |
| <b>M10</b>         | RNSSFHC1035    | 1.0                   | 4.0                   | 13.0         | 12.9                 | 17.0                   | 1.8                     | 27.0                       | 32.0                     | 28500              | 100          | £915.53          |
|                    | RNSSFHC1060    | 4.0                   | 6.0                   |              |                      |                        |                         | 30.0                       |                          |                    | 50           | £946.95          |

Grip range and test data are guide figures only

# REDUCED HEAD ROUND KNURLED BODY CLOSED BLIND RIVET NUT

A2 Stainless Steel (AISI304)

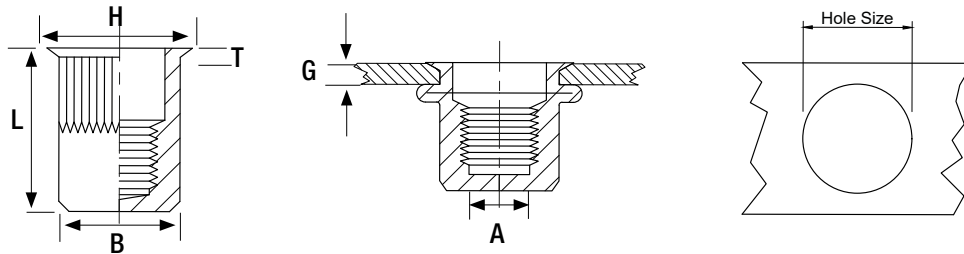

| Thread Size mm (A) | Article Number | Grip Range Min mm (G) | Grip Range Max mm (G) | Hole Size mm | Body Diameter mm (B) | Flange Diameter mm (H) | Flange Thickness mm (T) | Body Overall Length mm (L) | Max Tightening Torque Nm | Tensile Strength N | Box Quantity | Price £ Per 1000 |
|--------------------|----------------|-----------------------|-----------------------|--------------|----------------------|------------------------|-------------------------|----------------------------|--------------------------|--------------------|--------------|------------------|
| <b>M3</b>          | RNSSRHC0325    | 1.5                   | 2.5                   | 5.0          | 4.9                  | 6.0                    | 0.4                     | 13.0                       | 1.0                      | 3900               | 2000         | £240.46          |
| <b>M4</b>          | RNSSRHC0420    | 0.5                   | 2.0                   | 6.0          | 5.9                  | 7.0                    | 0.5                     | 15.0                       | 3.0                      | 6800               | 1000         | £259.45          |
|                    | RNSSRHC0440    | 2.0                   | 4.0                   |              |                      |                        |                         | 16.5                       |                          |                    | 1000         | £273.91          |
| <b>M5</b>          | RNSSRHC0520    | 0.5                   | 2.0                   | 7.0          | 6.9                  | 8.0                    | 0.6                     | 16.5                       | 6.0                      | 10000              | 1000         | £266.68          |
|                    | RNSSRHC0540    | 2.0                   | 4.0                   |              |                      |                        |                         | 18.0                       |                          |                    | 1000         | £288.83          |
| <b>M6</b>          | RNSSRHC0625    | 0.5                   | 2.5                   | 9.0          | 8.9                  | 10.0                   | 0.6                     | 20.5                       | 10.0                     | 15000              | 500          | £303.74          |
|                    | RNSSRHC0645    | 2.5                   | 4.5                   |              |                      |                        |                         | 22.0                       |                          |                    | 500          | £325.89          |
| <b>M8</b>          | RNSSRHC0830    | 0.5                   | 3.0                   | 11.0         | 10.9                 | 12.3                   | 0.6                     | 23.0                       | 24.0                     | 27000              | 250          | £434.82          |
|                    | RNSSRHC0850    | 3.0                   | 5.0                   |              |                      |                        |                         | 24.5                       |                          |                    | 250          | £467.37          |
| <b>M10</b>         | RNSSRHC1035    | 1.0                   | 3.5                   | 13.0         | 12.9                 | 14.5                   | 0.9                     | 24.5                       | 32.0                     | 28500              | 200          | £578.56          |
|                    | RNSSRHC1055    | 3.5                   | 5.5                   |              |                      |                        |                         | 26.0                       |                          |                    | 200          | £630.99          |

**NEW**

# REDUCED HEAD PART HEXAGON BODY CLOSED BLIND RIVET NUT

 A2 Stainless Steel (AISI304)

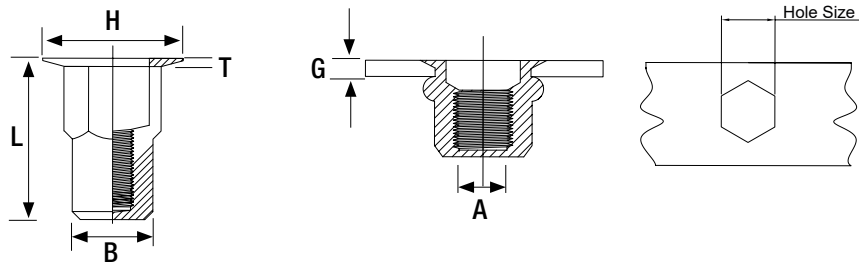

| Thread Size mm (A) | Article Number | Grip Range Min mm (G) | Grip Range Max mm (G) | Hole Size mm | Body Diameter mm (B) | Flange Diameter mm (H) | Flange Thickness mm (T) | Body Overall Length mm (L) | Max Tightening Torque Nm | Tensile Strength N | Box Quantity | Price £ Per 1000 |
|--------------------|----------------|-----------------------|-----------------------|--------------|----------------------|------------------------|-------------------------|----------------------------|--------------------------|--------------------|--------------|------------------|
| <b>M4</b>          | RNSSRPHC0420   | 0.5                   | 2.0                   | 6.0          | 5.9                  | 7.0                    | 0.5                     | 15.5                       | 4.0                      | 6800               | 1000         | <b>£266.23</b>   |
|                    | RNSSRPHC0440   | 2.0                   | 4.0                   |              |                      |                        |                         | 17.5                       |                          |                    | 1000         | <b>£288.83</b>   |
| <b>M5</b>          | RNSSRPHC0525   | 0.5                   | 2.5                   | 7.0          | 6.9                  | 8.0                    | 0.6                     | 18.0                       | 6.5                      | 10000              | 1000         | <b>£296.06</b>   |
|                    | RNSSRPHC0540   | 2.0                   | 4.0                   |              |                      |                        |                         | 20.0                       |                          |                    | 1000         | <b>£310.52</b>   |
| <b>M6</b>          | RNSSRPHC0630   | 1.0                   | 3.5                   | 9.0          | 8.9                  | 10.0                   | 0.6                     | 21.5                       | 12.0                     | 15000              | 500          | <b>£333.12</b>   |
|                    | RNSSRPHC0650   | 3.0                   | 5.0                   |              |                      |                        |                         | 23.0                       |                          |                    | 500          | <b>£354.82</b>   |
| <b>M8</b>          | RNSSRPHC0835   | 1.0                   | 3.5                   | 11.0         | 10.9                 | 12.5                   | 0.9                     | 24.0                       | 31.0                     | 27000              | 250          | <b>£475.05</b>   |
|                    | RNSSRPHC0850   | 3.0                   | 5.5                   |              |                      |                        |                         | 26.0                       |                          |                    | 250          | <b>£497.20</b>   |
| <b>M10</b>         | RNSSRPHC1040   | 1.0                   | 4.0                   | 13.0         | 12.9                 | 14.5                   | 0.9                     | 30.5                       | 42.0                     | 28500              | 200          | <b>£623.76</b>   |

**NEW**

*Grip range and test data are guide figures only*

# COUNTERSUNK HEAD ROUND KNURLED BODY CLOSED BLIND RIVET NUT

A2 Stainless Steel (AISI304)

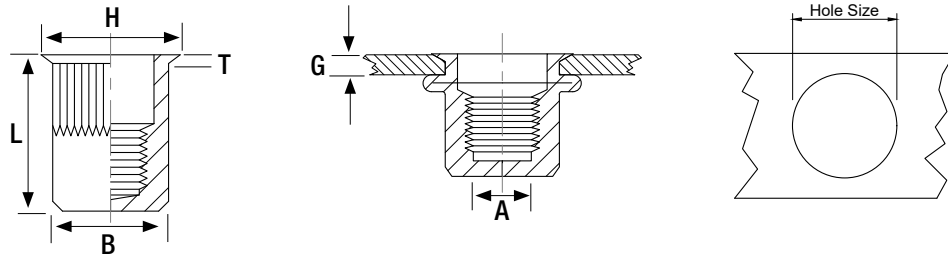

| Thread Size mm (A) | Article Number | Grip Range Min mm (G) | Grip Range Max mm (G) | Hole Size mm | Body Diameter mm (B) | Flange Diameter mm (H) | Flange Thickness mm (T) | Body Overall Length mm (L) | Max Tightening Torque Nm | Tensile Strength N | Box Quantity | Price £ Per 1000 |
|--------------------|----------------|-----------------------|-----------------------|--------------|----------------------|------------------------|-------------------------|----------------------------|--------------------------|--------------------|--------------|------------------|
| <b>M4</b>          | RNSSCHC0435    | 1.5                   | 3.5                   | 6.0          | 5.9                  | 9.0                    | 1.5                     | 17.5                       | 3.0                      | 6800               | 1000         | <b>£387.65</b>   |
| <b>M5</b>          | RNSSCHC0535    | 1.5                   | 3.5                   | 7.0          | 6.9                  | 10.0                   | 1.5                     | 20.0                       | 6.0                      | 10000              | 500          | <b>£403.10</b>   |
| <b>M6</b>          | RNSSCHC0640    | 1.5                   | 4.0                   | 9.0          | 8.9                  | 12.0                   | 1.5                     | 23.0                       | 10.0                     | 15000              | 500          | <b>£469.02</b>   |
| <b>M8</b>          | RNSSCHC0845    | 1.5                   | 4.5                   | 11.0         | 10.9                 | 14.0                   | 1.5                     | 26.5                       | 24.0                     | 27000              | 250          | <b>£668.24</b>   |
| <b>M10</b>         | RNSSCHC1050    | 1.5                   | 5.0                   | 13.0         | 12.9                 | 16.0                   | 1.7                     | 30.0                       | 32.0                     | 28500              | 100          | <b>£915.53</b>   |



# FLAT HEAD ROUND KNURLED BODY OPEN BLIND RIVET NUT

● A4 Stainless Steel (AISI316)

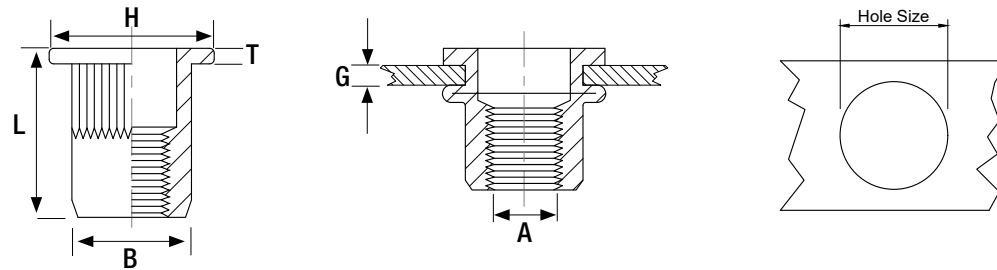

| Thread Size mm (A) | Article Number | Grip Range Min mm (G) | Grip Range Max mm (G) | Hole Size mm | Body Diameter mm (B) | Flange Diameter mm (H) | Flange Thickness mm (T) | Body Overall Length mm (L) | Max Tightening Torque Nm | Tensile Strength N | Box Quantity | Price £ Per 1000 |
|--------------------|----------------|-----------------------|-----------------------|--------------|----------------------|------------------------|-------------------------|----------------------------|--------------------------|--------------------|--------------|------------------|
| <b>M3</b>          | RNSS4FH0320    | 0.5                   | 1.5                   | 5.0          | 4.9                  | 7.0                    | 0.8                     | 9.0                        | 1.0                      | 3900               | 2000         | £307.58          |
| <b>M4</b>          | RNSS4FH0420    | 0.5                   | 2.0                   | 6.0          | 5.9                  | 9.0                    |                         | 10.5                       | 3.0                      | 6800               | 1500         | £307.96          |
| <b>M5</b>          | RNSS4FH0525    | 0.5                   | 2.5                   | 7.0          | 6.9                  | 10.0                   | 1.0                     | 13.0                       | 6.0                      | 10000              | 1000         | £321.67          |
| <b>M6</b>          | RNSS4FH0630    | 0.5                   | 3.0                   | 9.0          | 8.9                  | 12.5                   | 1.5                     | 15.5                       | 10.0                     | 15000              | 500          | £371.39          |
|                    | RNSS4FH0650    | 3.0                   | 5.0                   |              |                      |                        |                         | 19.5                       |                          |                    | 400          | £394.07          |
| <b>M8</b>          | RNSS4FH0835    | 1.0                   | 3.5                   | 11.0         | 10.9                 | 15.0                   |                         | 18.5                       | 24.0                     | 27000              | 300          | £568.63          |
|                    | RNSS4FH0860    | 3.5                   | 5.5                   |              |                      |                        |                         | 21.5                       |                          |                    | 250          | £591.70          |
| <b>M10</b>         | RNSS4FH1035    | 1.0                   | 4.0                   | 13.0         | 12.9                 | 17.0                   | 1.8                     | 21.0                       | 32.0                     | 28500              | 150          | £1,072.48        |
| <b>M12</b>         | RNSS4FH1240    | 1.0                   | 4.0                   | 16.0         | 15.9                 | 22.0                   | 2.0                     | 25.0                       | 44.0                     | 48000              | 100          | £1,533.19        |

*Grip range and test data are guide figures only*



# COUNTERSUNK HEAD ROUND KNURLED BODY OPEN BLIND RIVET NUT

 A4 Stainless Steel (AISI316)

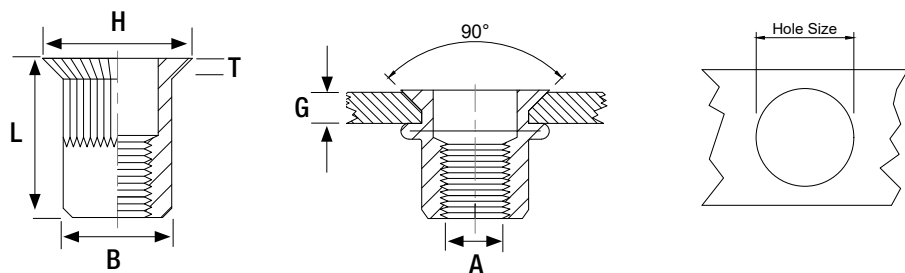

| Thread Size mm (A) | Article Number | Grip Range Min mm (G) | Grip Range Max mm (G) | Hole Size mm | Body Diameter mm (B) | Flange Diameter mm (H) | Flange Thickness mm (T) | Body Overall Length mm (L) | Max Tightening Torque Nm | Tensile Strength N | Box Quantity | Price £ Per 1000 |
|--------------------|----------------|-----------------------|-----------------------|--------------|----------------------|------------------------|-------------------------|----------------------------|--------------------------|--------------------|--------------|------------------|
| <b>M3</b>          | RNSS4CH0330    | 0.5                   | 1.5                   | 5.0          | 4.9                  | 7.5                    | 1.5                     | 8.5                        | 1.0                      | 3900               | 2000         | <b>£307.58</b>   |
| <b>M4</b>          | RNSS4CH0435    | 0.5                   | 2.0                   | 6.0          | 5.9                  | 9.0                    | 1.5                     | 12.0                       | 3.0                      | 6800               | 1500         | <b>£307.96</b>   |
| <b>M5</b>          | RNSS4CH0535    | 0.5                   | 2.0                   | 7.0          | 6.9                  | 10.0                   | 1.5                     | 13.0                       | 6.0                      | 10000              | 1000         | <b>£321.67</b>   |
| <b>M6</b>          | RNSS4CH0640    | 0.5                   | 2.5                   | 9.0          | 8.9                  | 12.0                   | 1.5                     | 15.5                       | 10.0                     | 15000              | 500          | <b>£371.39</b>   |
| <b>M8</b>          | RNSS4CH0845    | 0.5                   | 3.0                   | 11.0         | 10.9                 | 14.0                   | 1.5                     | 18.5                       | 24.0                     | 27000              | 300          | <b>£568.63</b>   |
| <b>M10</b>         | RNSS4CH1045    | 1.0                   | 3.5                   | 13.0         | 12.9                 | 16.0                   | 1.7                     | 21.0                       | 32.0                     | 28500              | 150          | <b>£1,072.48</b> |

# REDUCED HEAD ROUND KNURLED BODY OPEN BLIND RIVET NUT

● A4 Stainless Steel (AISI316)

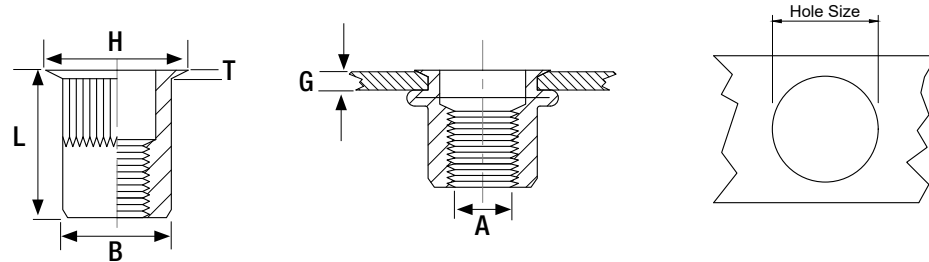

| Thread Size mm (A) | Article Number | Grip Range Min mm (G) | Grip Range Max mm (G) | Hole Size mm | Body Diameter mm (B) | Flange Diameter mm (H) | Flange Thickness mm (T) | Body Overall Length mm (L) | Max Tightening Torque Nm | Tensile Strength N | Box Quantity | Price £ Per 1000 |
|--------------------|----------------|-----------------------|-----------------------|--------------|----------------------|------------------------|-------------------------|----------------------------|--------------------------|--------------------|--------------|------------------|
| <b>M3</b>          | RNSS4RH0325    | 1.5                   | 1.5                   | 5.0          | 4.9                  | 5.5                    | 0.4                     | 9.0                        | 1.0                      | 3900               | 2000         | <b>£307.58</b>   |
| <b>M4</b>          | RNSS4RH0420    | 0.5                   | 2.0                   | 6.0          | 5.9                  | 7.0                    | 0.5                     | 10.5                       | 3.0                      | 6800               | 1500         | <b>£307.96</b>   |
| <b>M5</b>          | RNSS4RH0530    | 0.5                   | 2.0                   | 7.0          | 6.9                  | 8.0                    | 0.6                     | 11.5                       | 6.0                      | 10000              | 1000         | <b>£321.67</b>   |
| <b>M6</b>          | RNSS4RH0630    | 0.5                   | 2.5                   | 9.0          | 8.9                  | 10.0                   | 0.6                     | 14.0                       | 10.0                     | 15000              | 500          | <b>£371.39</b>   |
| <b>M8</b>          | RNSS4RH0835    | 0.5                   | 3.0                   | 11.0         | 10.9                 | 12.3                   | 0.6                     | 16.5                       | 24.0                     | 27000              | 300          | <b>£568.63</b>   |
| <b>M10</b>         | RNSS4RH1035    | 1.0                   | 3.5                   | 13.0         | 12.9                 | 14.5                   | 0.9                     | 17.7                       | 32.0                     | 28500              | 150          | <b>£1,072.48</b> |

*Grip range and test data are guide figures only*



# FLAT HEAD PART HEXAGON BODY OPEN BLIND RIVET NUT

● A4 Stainless Steel (AISI316)

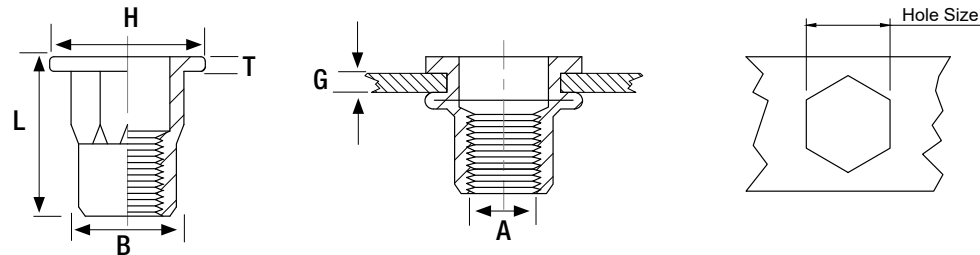

| Thread Size mm (A) | Article Number | Grip Range Min mm (G) | Grip Range Max mm (G) | Hole Size mm | Body Diameter mm (B) | Flange Diameter mm (H) | Flange Thickness mm (T) | Body Overall Length mm (L) | Max Tightening Torque Nm | Tensile Strength N | Box Quantity | Price £ Per 1000 |
|--------------------|----------------|-----------------------|-----------------------|--------------|----------------------|------------------------|-------------------------|----------------------------|--------------------------|--------------------|--------------|------------------|
| <b>M4</b>          | RNSS4FHPH0425  | 0.5                   | 2.0                   | 6.0          | 5.9                  | 9.0                    | 0.8                     | 12.0                       | 4.0                      | 6800               | 1500         | <b>£327.16</b>   |
| <b>M5</b>          | RNSS4FHPH0535  | 0.5                   | 2.5                   | 7.0          | 6.9                  | 10.0                   | 1.0                     | 12.0                       | 6.5                      | 10000              | 1000         | <b>£344.15</b>   |
| <b>M6</b>          | RNSS4FHPH0635  | 0.5                   | 3.0                   | 9.0          | 8.9                  | 12.7                   | 1.5                     | 15.5                       | 12.0                     | 15000              | 500          | <b>£380.91</b>   |
| <b>M8</b>          | RNSS4FHPH0835  | 1.0                   | 3.5                   | 11.0         | 10.9                 | 15.0                   | 1.5                     | 18.0                       | 31.0                     | 27000              | 300          | <b>£577.12</b>   |
| <b>M10</b>         | RNSS4FHPH1040  | 1.0                   | 4.0                   | 13.0         | 12.9                 | 17.0                   | 1.8                     | 21.0                       | 42.0                     | 28500              | 150          | <b>£1,052.51</b> |

# REDUCED HEAD PART HEXAGON BODY OPEN BLIND RIVET NUT

● A4 Stainless Steel (AISI316)

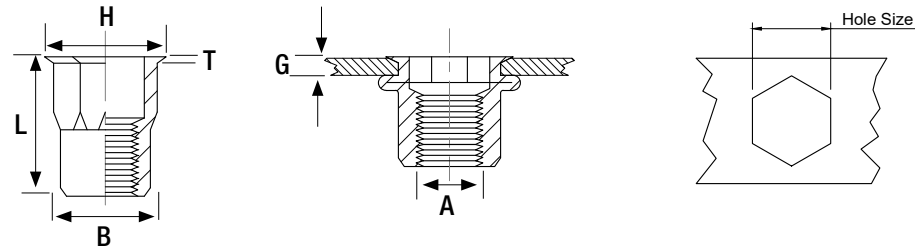

| Thread Size mm (A) | Article Number | Grip Range Min mm (G) | Grip Range Max mm (G) | Hole Size mm | Body Diameter mm (B) | Flange Diameter mm (H) | Flange Thickness mm (T) | Body Overall Length mm (L) | Max Tightening Torque Nm | Tensile Strength N | Box Quantity | Price £ Per 1000 |
|--------------------|----------------|-----------------------|-----------------------|--------------|----------------------|------------------------|-------------------------|----------------------------|--------------------------|--------------------|--------------|------------------|
| <b>M4</b>          | RNSS4RHPH0425  | 0.5                   | 2.0                   | 6.0          | 5.9                  | 7.0                    | 0.5                     | 12.0                       | 4.0                      | 6800               | 1500         | <b>£327.16</b>   |
| <b>M5</b>          | RNSS4RHPH0525  | 0.5                   | 2.5                   | 7.0          | 6.9                  | 8.0                    | 0.6                     | 13.0                       | 6.5                      | 10000              | 1000         | <b>£344.15</b>   |
| <b>M6</b>          | RNSS4RHPH0630  | 1.0                   | 3.0                   | 9.0          | 8.9                  | 10.0                   | 0.6                     | 16.0                       | 12.0                     | 15000              | 500          | <b>£380.91</b>   |
| <b>M8</b>          | RNSS4RHPH0835  | 1.0                   | 3.5                   | 11.0         | 10.9                 | 12.5                   | 0.6                     | 17.5                       | 31.0                     | 27000              | 300          | <b>£577.12</b>   |
| <b>M10</b>         | RNSS4RHPH1035  | 1.0                   | 4.0                   | 13.0         | 12.9                 | 14.3                   | 0.9                     | 21.0                       | 42.0                     | 28500              | 150          | <b>£1,052.51</b> |

*Grip range and test data are guide figures only*



# REDUCED HEAD ROUND KNURLED BODY CLOSED BLIND RIVET NUT

● A4 Stainless Steel (AISI316)

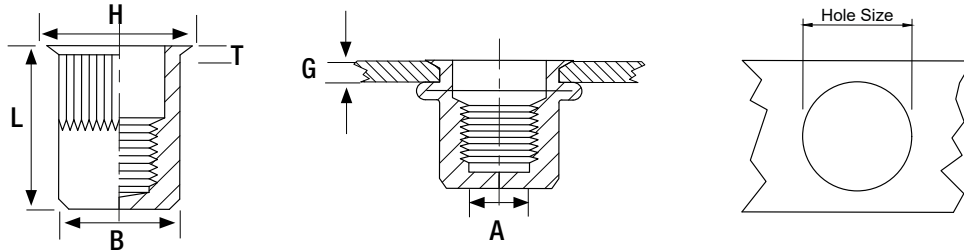

| Thread Size mm (A) | Article Number | Grip Range Min mm (G) | Grip Range Max mm (G) | Hole Size mm | Body Diameter mm (B) | Flange Diameter mm (H) | Flange Thickness mm (T) | Body Overall Length mm (L) | Max Tightening Torque Nm | Tensile Strength N | Box Quantity | Price £ Per 1000 |
|--------------------|----------------|-----------------------|-----------------------|--------------|----------------------|------------------------|-------------------------|----------------------------|--------------------------|--------------------|--------------|------------------|
| <b>M3</b>          | RNSS4RHC0325   | 1.5                   | 2.5                   | 5.0          | 4.9                  | 6.0                    | 0.4                     | 13.0                       | 1.0                      | 3900               | 2000         | £289.73          |
| <b>M4</b>          | RNSS4RHC0420   | 0.5                   | 2.0                   | 6.0          | 5.9                  | 7.0                    | 0.5                     | 15.0                       | 3.0                      | 6800               | 1500         | £300.13          |
| <b>M5</b>          | RNSS4RHC0520   | 0.5                   | 2.0                   | 7.0          | 6.9                  | 8.0                    | 0.6                     | 16.5                       | 6.0                      | 10000              | 1000         | £321.37          |
| <b>M6</b>          | RNSS4RHC0630   | 0.5                   | 2.5                   | 9.0          | 8.9                  | 10.0                   | 0.6                     | 20.5                       | 10.0                     | 15000              | 500          | £376.52          |
| <b>M8</b>          | RNSS4RHC0830   | 0.5                   | 3.0                   | 11.0         | 10.9                 | 12.3                   | 0.6                     | 23.0                       | 24.0                     | 27000              | 250          | £534.26          |
| <b>M10</b>         | RNSS4RHC1035   | 1.0                   | 3.5                   | 13.0         | 12.9                 | 14.5                   | 0.9                     | 24.5                       | 32.0                     | 28500              | 150          | £701.50          |

# NEW

# REDUCED HEAD PART HEXAGON BODY CLOSED BLIND RIVET NUT

● A4 Stainless Steel (AISI316)

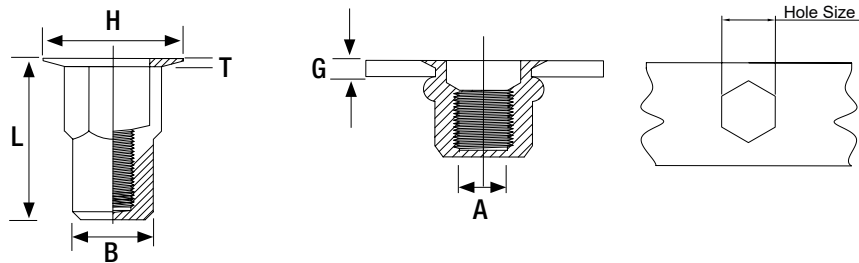

| Thread Size mm (A) | Article Number | Grip Range Min mm (G) | Grip Range Max mm (G) | Hole Size mm | Body Diameter mm (B) | Flange Diameter mm (H) | Flange Thickness mm (T) | Body Overall Length mm (L) | Max Tightening Torque Nm | Tensile Strength N | Box Quantity | Price £ Per 1000 |
|--------------------|----------------|-----------------------|-----------------------|--------------|----------------------|------------------------|-------------------------|----------------------------|--------------------------|--------------------|--------------|------------------|
| <b>M4</b>          | RNSS4RHPHC0420 | 0.5                   | 2.0                   | 6.0          | 5.9                  | 7.0                    | 0.5                     | 15.5                       | 4.0                      | 6800               | 1500         | £310.52          |
| <b>M5</b>          | RNSS4RHPHC0525 | 0.5                   | 2.5                   | 7.0          | 6.9                  | 8.0                    | 0.6                     | 18.0                       | 6.5                      | 10000              | 1000         | £354.37          |
| <b>M6</b>          | RNSS4RHPHC0630 | 1.0                   | 3.5                   | 9.0          | 8.9                  | 10.0                   | 0.6                     | 21.5                       | 12.0                     | 15000              | 500          | £424.88          |
| <b>M8</b>          | RNSS4RHPHC0835 | 1.0                   | 3.5                   | 11.0         | 10.9                 | 12.5                   | 0.6                     | 24.0                       | 31.0                     | 27000              | 250          | £577.66          |
| <b>M10</b>         | RNSS4RHPHC1040 | 1.0                   | 4.0                   | 13.0         | 12.9                 | 14.3                   | 0.9                     | 30.5                       | 42.0                     | 28500              | 150          | £748.06          |

**NEW**

*Grip range and test data are guide figures only*



# FLAT HEAD ROUND KNURLED BODY OPEN BLIND RIVET NUT

● Aluminium (AlMg 2.5)

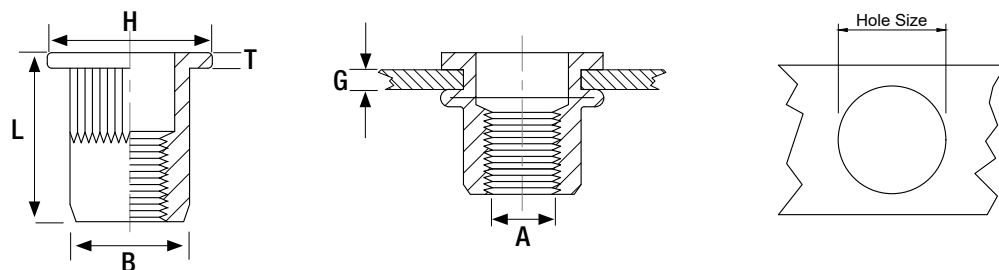

| Thread Size mm (A) | Article Number | Grip Range Min mm (G) | Grip Range Max mm (G) | Hole Size mm | Body Diameter mm (B) | Flange Diameter mm (H) | Flange Thickness mm (T) | Body Overall Length mm (L) | Max Tightening Torque Nm | Tensile Strength N | Box Quantity  | Price £ Per 1000 |
|--------------------|----------------|-----------------------|-----------------------|--------------|----------------------|------------------------|-------------------------|----------------------------|--------------------------|--------------------|---------------|------------------|
| <b>M3</b>          | RNAFH0320      | 0.5                   | 1.5                   | 5.0          | 4.9                  | 8.0                    | 0.8                     | 9.0                        | 0.7                      | 2500               | 2000          | <b>£60.10</b>    |
| <b>M4</b>          | RNAFH0420      | 0.5                   | 2.0                   | 6.0          | 5.9                  | 9.0                    |                         | 10.5                       | 2.0                      | 3600               | 1500          | <b>£70.53</b>    |
|                    | RNAFH0435      | 2.0                   | 3.5                   |              |                      |                        | 12.0                    | 1000                       |                          |                    | <b>£65.98</b> |                  |
| <b>M5</b>          | RNAFH0525      | 0.5                   | 2.5                   | 7.0          | 6.9                  | 10.0                   | 1.0                     | 13.0                       | 4.0                      | 5500               | 1000          | <b>£70.92</b>    |
|                    | RNAFH0550      | 2.5                   | 5.0                   |              |                      |                        |                         | 16.5                       |                          |                    | 500           | <b>£76.21</b>    |
|                    | RNAFH0580      | 5.5                   | 8.0                   |              |                      |                        |                         | 20.0                       |                          |                    | 500           | <b>£91.68</b>    |
| <b>M6</b>          | RNAFH0630      | 0.5                   | 2.5                   | 9.0          | 8.9                  | 12.3                   | 1.5                     | 15.0                       | 6.0                      | 8300               | 500           | <b>£77.74</b>    |
|                    | RNAFH0655      | 2.5                   | 4.5                   |              |                      |                        |                         | 19.5                       |                          |                    | 400           | <b>£84.27</b>    |
|                    | RNAFH0680      | 4.5                   | 6.5                   |              |                      |                        |                         | 21.0                       |                          |                    | 300           | <b>£99.68</b>    |
| <b>M8</b>          | RNAFH0830      | 1.0                   | 3.0                   | 11.0         | 10.9                 | 14.5                   | 1.5                     | 16.5                       | 15.0                     | 13000              | 300           | <b>£117.20</b>   |
|                    | RNAFH0855      | 3.0                   | 5.5                   |              |                      |                        |                         | 21.0                       |                          |                    | 250           | <b>£125.61</b>   |
|                    | RNAFH0880      | 5.5                   | 8.0                   |              |                      |                        |                         | 23.5                       |                          |                    | 200           | <b>£142.90</b>   |
| <b>M10</b>         | RNAFH1040      | 0.5                   | 4.0                   | 13.0         | 12.9                 | 16.5                   | 1.6                     | 19.0                       | 27.0                     | 20000              | 150           | <b>£200.22</b>   |
|                    | RNAFH1065      | 4.0                   | 6.5                   |              |                      |                        |                         | 24.0                       |                          |                    | 100           | <b>£220.45</b>   |
| <b>M12</b>         | RNAFH1240      | 1.0                   | 4.0                   | 16.0         | 15.9                 | 22.0                   | 2.0                     | 22.0                       | 45.0                     | 28000              | 100           | <b>£735.09</b>   |

# COUNTERSUNK HEAD ROUND KNURLED BODY OPEN BLIND RIVET NUT

● Aluminium (AlMg 2.5)

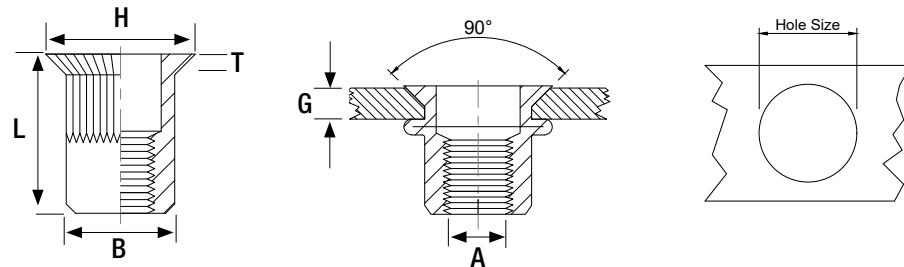

| Thread Size mm (A) | Article Number | Grip Range Min mm (G) | Grip Range Max mm (G) | Hole Size mm | Body Diameter mm (B) | Flange Diameter mm (H) | Flange Thickness mm (T) | Body Overall Length mm (L) | Max Tightening Torque Nm | Tensile Strength N | Box Quantity | Price £ Per 1000 |         |
|--------------------|----------------|-----------------------|-----------------------|--------------|----------------------|------------------------|-------------------------|----------------------------|--------------------------|--------------------|--------------|------------------|---------|
| <b>M3</b>          | RNACH0325      | 1.5                   | 2.5                   | 5.0          | 4.9                  | 7.5                    | 1.5                     | 8.5                        | 0.7                      | 2500               | 2000         | £60.10           |         |
| <b>M4</b>          | RNACH0430      | 1.5                   | 3.0                   | 6.0          | 5.9                  | 8.5                    |                         | 12.0                       | 2.0                      | 3600               | 1500         | 1500             | £66.54  |
|                    | RNACH0450      | 3.0                   | 5.0                   |              |                      |                        |                         | 1000                       |                          |                    |              | £65.98           |         |
| <b>M5</b>          | RNACH0535      | 1.5                   | 3.5                   | 7.0          | 6.9                  | 10.0                   |                         | 13.0                       | 4.0                      | 5500               | 1000         | 1000             | £78.06  |
|                    | RNACH0550      | 3.0                   | 5.0                   |              |                      |                        |                         | 15.0                       |                          |                    |              | 1000             | £71.90  |
| <b>M6</b>          | RNACH0640      | 1.5                   | 4.0                   | 9.0          | 8.9                  | 12.0                   |                         | 15.5                       | 6.0                      | 8300               | 500          | 500              | £73.34  |
|                    | RNACH0660      | 4.0                   | 6.0                   |              |                      |                        |                         | 17.0                       |                          |                    |              | 400              | £79.50  |
| <b>M8</b>          | RNACH0845      | 1.5                   | 4.5                   | 11.0         | 10.9                 | 14.0                   |                         | 18.5                       | 15.0                     | 13000              | 300          | 300              | £128.99 |
|                    | RNACH0860      | 4.0                   | 6.0                   |              |                      |                        |                         | 19.0                       |                          |                    |              | 250              | £118.50 |
| <b>M10</b>         | RNACH1050      | 1.5                   | 5.0                   | 13.0         | 12.9                 | 16.0                   |                         | 21.0                       | 27.0                     | 20000              | 150          | 150              | £244.47 |
|                    | RNACH1065      | 3.5                   | 6.5                   |              |                      |                        |                         | 24.0                       |                          |                    |              | 100              | £234.51 |
| <b>M12</b>         | RNACH1250      | 2.0                   | 5.0                   | 16.0         | 15.9                 | 19.0                   |                         | 1.9                        | 22.0                     | 45.0               | 28000        | 100              | £693.49 |

Grip range and test data are guide figures only





# REDUCED HEAD ROUND KNURLED BODY OPEN BLIND RIVET NUT

● Aluminium (AlMg 2.5)

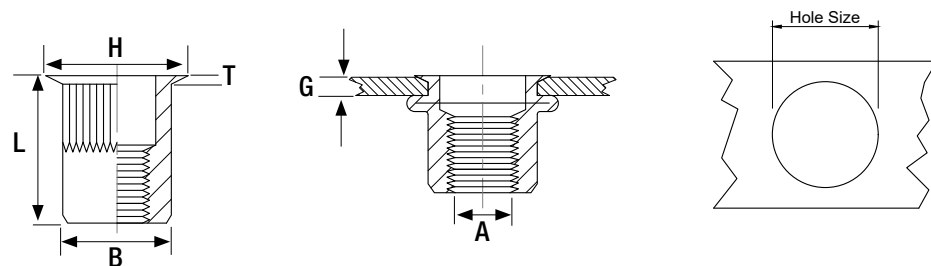

| Thread Size mm (A) | Article Number | Grip Range Min mm (G) | Grip Range Max mm (G) | Hole Size mm | Body Diameter mm (B) | Flange Diameter mm (H) | Flange Thickness mm (T) | Body Overall Length mm (L) | Max Tightening Torque Nm | Tensile Strength N | Box Quantity | Price £ Per 1000 |
|--------------------|----------------|-----------------------|-----------------------|--------------|----------------------|------------------------|-------------------------|----------------------------|--------------------------|--------------------|--------------|------------------|
| <b>M3</b>          | RNARH0320      | 0.5                   | 1.5                   | 5.0          | 4.9                  | 6.0                    | 0.5                     | 9.0                        | 0.7                      | 2500               | 2000         | <b>£60.10</b>    |
| <b>M4</b>          | RNARH0420      | 0.5                   | 2.0                   | 6.0          | 5.9                  | 7.0                    | 0.5                     | 10.5                       | 2.0                      | 3600               | 1500         | <b>£73.22</b>    |
| <b>M5</b>          | RNARH0520      | 0.5                   | 2.0                   | 7.0          | 6.9                  | 8.0                    | 0.5                     | 11.5                       | 4.0                      | 5500               | 1000         | <b>£70.92</b>    |
| <b>M6</b>          | RNARH0625      | 0.5                   | 2.5                   | 9.0          | 8.9                  | 10.0                   | 0.6                     | 14.0                       | 6.0                      | 8300               | 500          | <b>£77.74</b>    |
| <b>M8</b>          | RNARH0825      | 0.5                   | 2.5                   | 11.0         | 10.9                 | 12.0                   | 0.7                     | 15.5                       | 15.0                     | 13000              | 300          | <b>£136.73</b>   |
| <b>M10</b>         | RNARH1030      | 1.0                   | 3.0                   | 12.0         | 11.9                 | 14.0                   | 0.7                     | 17.7                       | 27.0                     | 20000              | 150          | <b>£191.12</b>   |



# HAND TOOLING

# HAND TOOLS

JRP offer a range of hand tools designed to install the JRP blind fastening products.



## MANUAL OPERATION

Ideal for situations where precise control is required, designed to drive, and set the rivet or rivet nut in place.



## SIMPLISTIC DESIGN

A slim design for easy access, the JRP hand tools require minimal maintenance.



## LIGHTWEIGHT

The lightweight design means the tools are easy to transport and use where spaces may be tight.



## COST-EFFECTIVE

A cost-effective option, suitable for smaller riveting jobs.



## COMPLETE PACKAGE

All hand tools are supplied in a box or case and include a comprehensive instruction manual. Tools come complete with nosepieces/mandrels, and additional replacement parts are available to order upon request.



## FEATURES



SLIM DESIGN  
FOR EASY  
ACCESS



PORTABLE USE  
INSIDE AND  
OUTSIDE



ERGONOMIC HANDLES  
FOR COMFORT AND  
EASE OF USE



MANUAL OPERATION  
FOR PRECISE  
CONTROL



INSTRUCTION  
MANUAL  
INCLUDED



# BLIND RIVET HAND TOOLS

|                   | Article Number | Description                            | Box Quantity | Price £ Per One | Box Contents |
|-------------------|----------------|--|--------------|-----------------|--------------|
| TOOL              | JRPS350B       | SC350B JRP RIVET PLIERS (2.4-5.0)      | 1            | £17.05          | 1            |
| REPLACEMENT PARTS | TSZ20041H00    | 2 PIECE JAW SET                        | 1            | £0.84           | 1            |
|                   | TSL21417H00    | 2.4MM NOSEPIECE (A)                    | 1            | £0.63           | 1            |
|                   | TSL20401H01    | 3.0/3.2MM NOSEPIECE (B)                | 1            | £0.63           | 1            |
|                   | TSL20402H01    | 4.0MM NOSEPIECE (C)                    | 1            | £0.63           | 1            |
|                   | TSL20403H01    | 4.8/5.0MM NOSEPIECE (D)                | 1            | £0.74           | 1            |
| TOOL              | JRPRD50        | RD50 JRP RIVET LEVER TOOL (3.0-5.0)    | 1            | £60.96          | 1            |
| REPLACEMENT PARTS | TSA0004701     | 2 PIECE JAW SET                        | 1            | £1.21           | 1            |
|                   | TSA0040702     | 3.0/3.2MM NOSEPIECE (B)                | 1            | £0.58           | 1            |
|                   | TSA0040802     | 4.0MM NOSEPIECE (C)                    | 1            | £0.58           | 1            |
|                   | TSA0040902     | 4.8/5.0MM NOSEPIECE (D)                | 1            | £0.58           | 1            |
| TOOL              | JRPRD64        | RD64 JRP HD RIVET LEVER TOOL (3.0-6.4) | 1            | £82.71          | 1            |
| REPLACEMENT PARTS | TSA003502      | 3 PIECE JAW SET                        | 1            | £3.73           | 1            |
|                   | TSA001803      | 3.0/3.2MM NOSEPIECE (B)                | 1            | £3.83           | 1            |
|                   | TSA001903      | 4.0MM NOSEPIECE (C)                    | 1            | £3.83           | 1            |
|                   | TSA002003      | 4.8/5.0MM NOSEPIECE (D)                | 1            | £3.83           | 1            |
|                   | TSA002103      | 6.0MM NOSEPIECE (E)                    | 1            | £3.83           | 1            |
|                   | TSA002203      | 6.4MM NOSEPIECE (F)                    | 1            | £3.83           | 1            |

JRPS350B



**STROKE** - 9mm  
**WEIGHT** - 0.57kg  
**CAPACITY** - 2.4-5.0mm

Additional nose pieces stored in the side of the tool.

JRPRD50



**STROKE** - 5mm  
**WEIGHT** - 0.85kg  
**CAPACITY** - 3.0-5.0mm

Additional nose pieces stored inside the tool.

Mandrel collector for cleanliness and safety.

JRPRD64



**STROKE** - 12mm  
**WEIGHT** - 1.04kg  
**CAPACITY** - 3.0-6.4mm

Additional nose pieces stored inside the tool.

Mandrel collector for cleanliness and safety.



# BLIND RIVET NUT HAND TOOLS

RIVETS

NUTS

TOOLS



|                   | Article Number | Description                       | Box Quantity | Price £ Per One | JRPSM360G Box Contents |
|-------------------|----------------|-----------------------------------|--------------|-----------------|------------------------|
| TOOL              | JRPSM360G      | SM360G JRP RIV-NUT PLIERS (M3-M6) | 1            | £47.69          | 1                      |
| REPLACEMENT PARTS | TSA0005200     | M3 MANDREL                        | 1            | £4.54           | 1                      |
|                   | TSA0005300     | M4 MANDREL                        | 1            | £4.64           | 1                      |
|                   | TSA0005400     | M5 MANDREL                        | 1            | £4.68           | 1                      |
|                   | TSA0005500     | M6 MANDREL                        | 1            | £4.54           | 1                      |
|                   | TSP0043400     | M3 HEAD                           | 1            | £3.15           | 1                      |
|                   | TSP0043600     | M4 HEAD                           | 1            | £3.15           | 1                      |
|                   | TSP0043700     | M5 HEAD                           | 1            | £3.15           | 1                      |
|                   | TSP0043800     | M6 HEAD                           | 1            | £3.15           | 1                      |
|                   | TSP0043500     | ADJUSTMENT NUT                    | 1            | £1.10           | 1                      |



JRPSM360G

**STROKE** - 0-9mm  
**WEIGHT** - 0.72kg  
**CAPACITY** - M3-M6



|                   | Article Number | Description                         | Box Quantity | Price £ Per One | JRPND80 Box Contents |
|-------------------|----------------|-------------------------------------|--------------|-----------------|----------------------|
| TOOL              | JRPND80        | ND80 JRP RIV-NUT LEVER TOOL (M3-M8) | 1            | £72.54          | 1                    |
| REPLACEMENT PARTS | TSL41728H00    | M3 MANDREL                          | 1            | £3.55           | 1                    |
|                   | TSL41727H00    | M4 MANDREL                          | 1            | £3.55           | 1                    |
|                   | TSL41726H00    | M5 MANDREL                          | 1            | £3.55           | 1                    |
|                   | TSL41725H00    | M6 MANDREL                          | 1            | £3.55           | 1                    |
|                   | TSL41735H00    | M8 MANDREL*                         | 1            | £3.55           | 1                    |
|                   | TSZ21354H00    | M3 HEAD                             | 1            | £2.75           | 1                    |
|                   | TSZ21355H00    | M4 HEAD                             | 1            | £2.75           | 1                    |
|                   | TSZ21356H00    | M5 HEAD                             | 1            | £2.75           | 1                    |
|                   | TSZ21357H00    | M6 HEAD                             | 1            | £2.75           | 1                    |
|                   | TSZ21358H00    | M8 HEAD*                            | 1            | £2.75           | 1                    |
|                   | TSL41736H00    | ADJUSTMENT NUT                      | 1            | £0.80           | 1                    |



JRPND80

**STROKE** - 0-5mm  
**WEIGHT** - 1.02kg  
**CAPACITY** - M3-M8  
*\*M8 Aluminium rivet nuts only.*





# BLIND RIVET NUT HAND TOOLS

|                   | Article Number | Description                            | Box Quantity | Price £ Per One | JRPND120 Box Contents |
|-------------------|----------------|--|--------------|-----------------|-----------------------|
| TOOL              | JRPND120       | ND120 JRP HD RIV-NUT LEVER TOOL M5-M12 | 1            | £93.24          | 1                     |
| REPLACEMENT PARTS | TSL23037H00    | M5 MANDREL                             | 1            | £3.33           | 1                     |
|                   | TSL23036H00    | M6 MANDREL                             | 1            | £4.26           | 1                     |
|                   | TSL23035H00    | M8 MANDREL                             | 1            | £4.26           | 1                     |
|                   | TSL23034H00    | M10 MANDREL                            | 1            | £4.26           | 1                     |
|                   | TSL23033H00    | M12 MANDREL                            | 1            | £7.19           | 1                     |
|                   | TSZ21309H00    | M5 HEAD                                | 1            | £3.24           | 1                     |
|                   | TSZ21308H00    | M6 HEAD                                | 1            | £3.24           | 1                     |
|                   | TSZ21307H00    | M8 HEAD                                | 1            | £3.24           | 1                     |
|                   | TSZ21306H00    | M10 HEAD                               | 1            | £3.24           | 1                     |
|                   | TSZ21305H00    | M12 HEAD                               | 1            | £3.24           | 1                     |
|                   | TSL23049H00    | ADJUSTMENT NUT                         | 1            | £0.84           | 1                     |



JRPND120

**STROKE** - 0-6mm  
**WEIGHT** - 1.58kg  
**CAPACITY** - M5-M12



|                   | Article Number | Description                           | Box Quantity | Price £ Per One | JRPNH120 Box Contents |
|-------------------|----------------|---------------------------------------|--------------|-----------------|-----------------------|
| TOOL              | JRPNH120       | NH120 JRP RIV-NUT RATCHET TOOL M6-M12 | 1            | £222.89         | 1                     |
| REPLACEMENT PARTS | TSL23037H00    | M5 MANDREL                            | 1            | £3.33           |                       |
|                   | TSL23036H00    | M6 MANDREL                            | 1            | £4.26           | 1                     |
|                   | TSL23035H00    | M8 MANDREL                            | 1            | £4.26           | 1                     |
|                   | TSL23034H00    | M10 MANDREL                           | 1            | £4.26           | 1                     |
|                   | TSL23033H00    | M12 MANDREL                           | 1            | £7.19           | 1                     |
|                   | TSZ21011H00    | M5 HEAD (PURPLE)                      | 1            | £11.94          |                       |
|                   | TSZ21010H00    | M6 HEAD (BLUE)                        | 1            | £11.94          | 1                     |
|                   | TSZ21009H00    | M8 HEAD (RED)                         | 1            | £11.94          | 1                     |
|                   | TSZ21008H00    | M10 HEAD (WHITE)                      | 1            | £11.94          | 1                     |
|                   | TSZ21007H00    | M12 HEAD (BLACK)                      | 1            | £12.30          | 1                     |
|                   | TSL23051H00    | ADJUSTMENT NUT                        | 1            | £3.02           | 1                     |



JRPNH120

**STROKE** - 8mm  
**WEIGHT** - 1kg  
**CAPACITY** - M3-M12

*M3 and M4 mandrels and heads are factory order parts only.  
 M5 mandrel and head are spare order parts only.*



# BLIND RIVET NUT HAND TOOLS

|      | Article Number | Description                            | Box Quantity | Price £ Per One | JRPJK480 Box Contents |
|------|----------------|--|--------------|-----------------|-----------------------|
| TOOL | JRPJK480       | JK480 JK Split Nut Hand Pliers (M4-M8) | 1            | £14.30          | 1                     |



**WEIGHT** - 0.45kg  
**CAPACITY** - M4-M8

For use specifically with Flat Head Round JK Split Body Open Blind Rivet Nuts

|      | Article Number | Description                                | Box Quantity | Price £ Per One | JRPJKIW46 Box Contents |
|------|----------------|--|--------------|-----------------|------------------------|
| TOOL | JRPJKIW46      | JKIW46 JK Hand Installation Wrench (M4-M6) | 1            | £9.10           | 1                      |



**WEIGHT** - 0.01kg  
**CAPACITY** - M4-M6

For use specifically with Flat Head Round JK Split Body Open Blind Rivet Nuts

# BLIND RIVET TOOL CAPACITY GUIDE

## HAND TOOLS

| Tool Model : JRPC350B  |                |       |          |          |        |
|--|----------------|-------|----------|----------|--------|
| Tool comes complete with<br>2.4, 3.0/3.2, 4.0 & 4.8mm Nosepieces |                |       |          |          |        |
| Diameter<br>Size   | Rivet Material |       |          |          |        |
|  | Alum           | Steel | A2 St/St | A4 St/St | Copper |
| 2.4  |                | X     | X        | N/A      | N/A    |
| 3.0  |                |       |          |          |        |
| 3.2  |                |       |          |          |        |
| 4.0  |                |       |          |          |        |
| 4.8  |                |       |          |          |        |
| 5.0  | X              | X     | X        | X        | N/A    |
| 6.0  | X              | X     | X        | X        | N/A    |
| 6.4  | X              | X     | X        | X        | N/A    |

| Tool Model : JRPRD50  |                |       |          |          |        |
|---|----------------|-------|----------|----------|--------|
| Tool comes complete with<br>3.0/3.2, 4.0 & 4.8/5.0mm Nosepieces |                |       |          |          |        |
| Diameter<br>Size  | Rivet Material |       |          |          |        |
|   | Alum           | Steel | A2 St/St | A4 St/St | Copper |
| 2.4   | X              | X     | X        | N/A      | N/A    |
| 3.0   |                |       |          |          |        |
| 3.2   |                |       |          |          |        |
| 4.0   |                |       |          |          |        |
| 4.8   |                |       |          |          |        |
| 5.0   |                |       |          |          | N/A    |
| 6.0   | X              | X     | X        | X        | N/A    |
| 6.4   | X              | X     | X        | X        | N/A    |

| Tool Model : JRPRD64  |                |       |          |          |        |
|---|----------------|-------|----------|----------|--------|
| Tool comes complete with<br>3.0/3.2, 4.0, 4.8/5.0, 6.0 & 6.4mm Nosepieces |                |       |          |          |        |
| Diameter<br>Size  | Rivet Material |       |          |          |        |
|   | Alum           | Steel | A2 St/St | A4 St/St | Copper |
| 2.4   | X              | X     | X        | N/A      | N/A    |
| 3.0   |                |       |          |          |        |
| 3.2   |                |       |          |          |        |
| 4.0   |                |       |          |          |        |
| 4.8   |                |       |          |          |        |
| 5.0   |                |       |          |          | N/A    |
| 6.0   |                |       |          |          | N/A    |
| 6.4   |                |       |          |          | N/A    |



# BLIND RIVET NUT TOOL CAPACITY GUIDE

## HAND TOOLS



| Tool Model : JRPSM360G                                    |                    |       |          |          |
|---|--------------------|-------|----------|----------|
| Tool comes complete with M3, M4, M5 & M6 Mandrels & Heads |                    |       |          |          |
| Thread Size   | Rivet Nut Material |       |          |          |
|   | Alum               | Steel | A2 St/St | A4 St/St |
| M3  |                    |       |          |          |
| M4  |                    |       |          |          |
| M5  |                    |       |          |          |
| M6  |                    |       |          |          |
| M8  | X                  | X     | X        | X        |
| M10   | X                  | X     | X        | X        |
| M12   | X                  | X     | X        | X        |

| Tool Model : JRPND80  |                    |       |          |          |
|---|--------------------|-------|----------|----------|
| Tool comes complete with M3, M4, M5, M6 & M8 Mandrels & Heads |                    |       |          |          |
| Thread Size   | Rivet Nut Material |       |          |          |
|   | Alum               | Steel | A2 St/St | A4 St/St |
| M3  |                    |       |          |          |
| M4  |                    |       |          |          |
| M5  |                    |       |          |          |
| M6  |                    |       |          |          |
| M8  |                    | X     | X        | X        |
| M10   | X                  | X     | X        | X        |
| M12   | X                  | X     | X        | X        |

| Tool Model : JRPND120   |                    |       |          |          |
|---|--------------------|-------|----------|----------|
| Tool comes complete with M5, M6, M8, M10 & M12 Mandrels & Heads |                    |       |          |          |
| Thread Size   | Rivet Nut Material |       |          |          |
|   | Alum               | Steel | A2 St/St | A4 St/St |
| M3  | X                  | X     | X        | X        |
| M4  | X                  | X     | X        | X        |
| M5  |                    |       |          |          |
| M6  |                    |       |          |          |
| M8  |                    |       |          |          |
| M10   |                    |       |          |          |
| M12   |                    |       |          |          |

| Tool Model : JRPNH120                                       |                    |       |          |          |
|---|--------------------|-------|----------|----------|
| Tool comes complete with M6, M8, M10 & M12 Mandrels & Heads |                    |       |          |          |
| Thread Size   | Rivet Nut Material |       |          |          |
|   | Alum               | Steel | A2 St/St | A4 St/St |
| M3  |                    |       |          |          |
| M4  |                    |       |          |          |
| M5  |                    |       |          |          |
| M6  |                    |       |          |          |
| M8  |                    |       |          |          |
| M10   |                    |       |          |          |
| M12   |                    |       |          |          |

M3 & M4 Mandrels & Heads are factory order parts only.  
M5 Mandrel & Head are spare order parts only.

| Tool Model : JRPJK480 |                    |       |          |          |
|-----------------------|--------------------|-------|----------|----------|
| 1 Hand Plier Tool     |                    |       |          |          |
| Thread Size           | Rivet Nut Material |       |          |          |
|                       | Alum               | Steel | A2 St/St | A4 St/St |
| M3                    | X                  | X     | X        | X        |
| M4                    | X                  |       | X        | X        |
| M5                    | X                  |       | X        | X        |
| M6                    | X                  |       | X        | X        |
| M8                    | X                  |       | X        | X        |
| M10                   | X                  | X     | X        | X        |
| M12                   | X                  | X     | X        | X        |

| Tool Model : JRPJKI46      |                    |       |          |          |
|----------------------------|--------------------|-------|----------|----------|
| 1 Hand Installation Wrench |                    |       |          |          |
| Thread Size                | Rivet Nut Material |       |          |          |
|                            | Alum               | Steel | A2 St/St | A4 St/St |
| M3                         | X                  | X     | X        | X        |
| M4                         | X                  |       | X        | X        |
| M5                         | X                  |       | X        | X        |
| M6                         | X                  |       | X        | X        |
| M8                         | X                  | X     | X        | X        |
| M10                        | X                  | X     | X        | X        |
| M12                        | X                  | X     | X        | X        |



# BATTERY TOOLING

# BATTERY TOOLS

To complement the JRP hand tools, we have added a range of battery tools capable of installing the JRP blind fastening products. The new tools are some of the most compact power-to-weight ratio tools to be introduced to the marketplace.

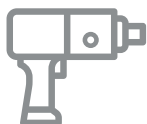

## BRUSHLESS TECHNOLOGY

JRP battery tools feature Brushless Technology (BLDC) motors. The main advantages of a brushless motor over brushed motors include increased reliability, high power-to-weight ratio, nearly instantaneous control of high speed and torque, high efficiency, and low maintenance. The traction force and stroke setting of the tools can be easily adjusted via the integrated control panel at the touch of a button.



## LI-ION BATTERIES

The tools are powered by 18V 2.0Ah Li-ion batteries designed to give higher performance and increased runtimes of almost 120 minutes, depending on the tool model and fasteners being set. All batteries have Electronic Cell Protection (ECP) which protects overload, overheating and deep discharge. The batteries take less than 30 minutes to fully re-charge. Additionally, there is an LED charge status indicator on the back of each battery. A simple push of a button indicates the current charge status and a quick reference for when to be re-charged.



## ECP TECHNOLOGY

The ECP system automatically shuts the tool down if it detects the battery is becoming overloaded or overheated and, as a result, ensures that the battery cannot reach a critical level of discharge. This is designed to keep the batteries performing at their maximum for longer and offer a lifespan of nearly 1000 charges.



## INTEGRATED LED LIGHT

Integrated LED light indicates that the power is on and the tool is ready for use. It also provides perfect illumination in the darkest working area.



## COMPLETE PACKAGE

All tools are lightweight and safely free stand when not in use. They are all supplied in a damage-resistant plastic case and include a comprehensive instruction manual.

All tools are CE/UKCA approved and carry as standard a 12-month warranty.



## FEATURES



2 X 18V 2.0AH  
LI-ION BATTERIES



PORTABLE USE  
INSIDE AND  
OUTSIDE



EASILY ADJUSTABLE  
CONTROL SETTINGS



ERGONOMIC DESIGN  
FOR COMFORT AND  
EASE OF USE



HIGH POWER-TO-  
WEIGHT-RATIO

BRUSHLESS TECHNOLOGY



# BLIND RIVET BATTERY TOOLS

JRPRB65

|                   | Article Number | Description  | Box Quantity                      | Price £ Per One | JRPRB65 Case Contents |   |
|-------------------|----------------|--------------|-----------------------------------|-----------------|-----------------------|---|
| REPLACEMENT PARTS | TOOL           | JRPRB65      | RB65 BATTERY RIVET TOOL (2.4-5.0) | 1               | £442.11               | 1 |
|                   |                | TSBZ40102H00 | 3 PIECE JAW SET (5.0)             | 1               | £22.00                | 1 |
|                   |                | TSBL40106H00 | 2.4MM NOSEPIECE (A)               | 1               | £9.81                 | 1 |
|                   |                | TSBL40105H00 | 3.0/3.2MM NOSEPIECE (B)           | 1               | £9.81                 | 1 |
|                   |                | TSBL40104H00 | 4MM NOSEPIECE (C)                 | 1               | £9.81                 | 1 |
|                   |                | TSBL40103H00 | 4.8/5.0MM NOSEPIECE (D)           | 1               | £9.81                 | 1 |
|                   |                | TSBL42101H00 | FRONT SLEEVE ASSEMBLY             | 1               | £39.93                |   |
|                   |                | TSBL42103H00 | PUSH PIN                          | 1               | £2.10                 |   |
|                   |                | TSBL42104H00 | PUSH PIN SPRING                   | 1               | £2.24                 |   |
|                   |                | TSBL42105H00 | MANDREL RELEASE TUBE              | 1               | £7.08                 |   |
|                   |                | TSBZ41704H00 | MANDREL RELEASE TUBE ASSY         | 1               | £7.08                 |   |
|                   |                | TSBZ41721H00 | GEAR BOX                          | 1               | £348.13               |   |
|                   |                | TSBZ41774H00 | PCB                               | 1               | £201.50               |   |
|                   |                | TSBZ41772H00 | BRUSHLESS MOTOR                   | 1               | £45.83                |   |
|                   |                | TSBL23003H00 | RUBBER RING                       | 1               | £1.47                 |   |
|                   |                | TSBL42102H00 | CLAMPING SLEEVE                   | 1               | £26.90                |   |
|                   |                | TSBZ41720H00 | SPRING SLEEVE                     | 1               | £12.61                |   |
|                   |                | TSBL42118H00 | MANDREL COLLECTOR                 | 1               | £11.77                |   |
|                   |                | TSBL42132H00 | CONTROL PANEL                     | 1               | £14.01                |   |
|                   |                | TSBL43006H00 | PROTECTOR                         | 1               | £4.20                 |   |
|                   |                | TSBL23002H00 | SCREW COVER                       | 1               | £13.17                |   |
|                   |                | TSBF60577H00 | SELF DRILL SCREW                  | 1               | £0.21                 |   |
|                   |                | TSBZ41709H00 | BODY (BLUE)                       | 1               | £74.61                |   |
|                   |                | TSBZ41718H00 | BATTERY 18V-2.0A-36W              | 1               | £140.11               | 2 |
|                   |                | TSBZ41734H00 | CHARGER UK ECP-BR-5A              | 1               | £84.07                | 1 |
|                   |                | TSBL42162H00 | SPRING FOR TRIGGER                | 1               | £1.40                 |   |
|                   |                | TSBL42133H00 | TRIGGER                           | 1               | £8.76                 |   |
|                   | TSBL42157H00   | SPANNER      | 1                                 | £3.08           | 1                     |   |

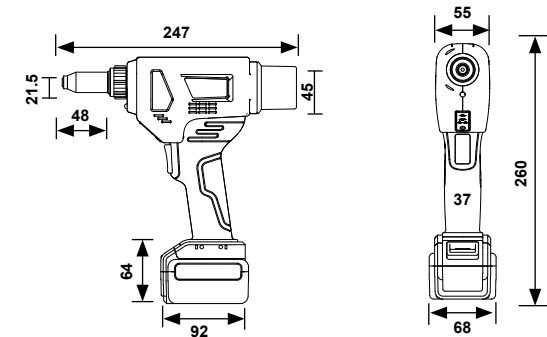

| Technical Data             |                               |
|----------------------------|-------------------------------|
| Capacity                   | 2.4-5.0mm                     |
| Material Capabilities      | Blind Rivet in All Materials. |
| Motor Type                 | 18V Brushless Technology      |
| Vibration Magnitude        | 1.5m/s <sup>2</sup>           |
| Noise Level                | < 90dB                        |
| Riveting Style             | Conventional Pull             |
| Traction Force             | 12000N                        |
| Stroke Length              | 21.0mm Max                    |
| Weight (Net incl. battery) | 1.44kg                        |

Watch our Battery Tools video here

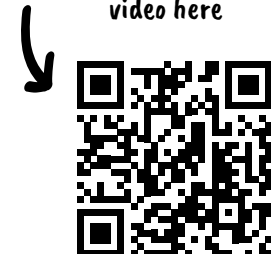



# BLIND RIVET BATTERY TOOLS

JRPRB66

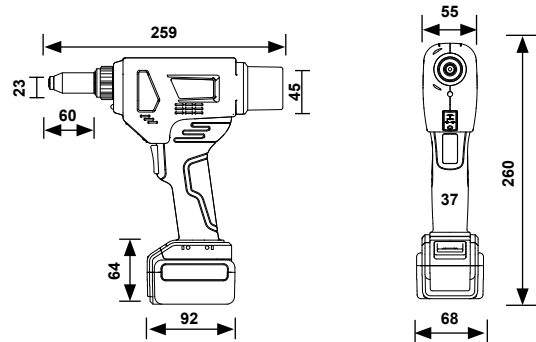

| Technical Data             |  |
|----------------------------|--|
| Capacity                   | 3.2-6.4mm  |
| Material Capabilities      | Blind Rivet Including Structural in All Materials. |
| Motor Type                 | 18V Brushless Technology                           |
| Vibration Magnitude        | 1.5m/s <sup>2</sup>                                |
| Noise Level                | < 90dB   |
| Riveting Style             | Conventional Pull                                  |
| Traction Force             | 18000N   |
| Stroke Length              | 26.0mm Max   |
| Weight (Net incl. battery) | 1.60kg   |

Watch our Battery Tools video here

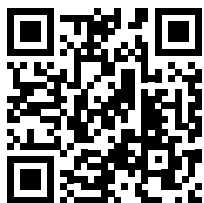

|                   | Article Number       | Description                        | Box Quantity | Price £ Per One | JRPRB66 Case Contents |
|-------------------|----------------------|------------------------------------|--------------|-----------------|-----------------------|
| TOOL              | JRPRB66              | RB66 BATTERY RIVET TOOL (3.2-6.4)  | 1            | £834.75         | 1                     |
| REPLACEMENT PARTS | TSBZ40102H00         | 3 PIECE JAW SET (5.0)              | 1            | £22.00          | 1                     |
|                   | TSBZ20320H00         | 3 PIECE JAW SET (6.4)              | 1            | £25.22          | 1                     |
|                   | TSBL40105H00         | 3.2MM NOSEPIECE (B)                | 1            | £9.81           | 1                     |
|                   | TSBL40104H00         | 4.0MM NOSEPIECE (C)                | 1            | £9.81           | 1                     |
|                   | TSBL40103H00         | 4.8/5.0MM NOSEPIECE (D)            | 1            | £9.81           | 1                     |
|                   | TSBL21606H00         | 6.0MM NOSEPIECE (E)                | 1            | £10.30          | 1                     |
|                   | TSBL21605H00         | 6.4MM NOSEPIECE (F)                | 1            | £10.30          | 1                     |
|                   | TSBL21638H00 *       | 4.8/5.0 NOSEPIECE (G) M/BOLT       | 1            | £12.75          |                       |
|                   | TSBL21603H00 *       | 4.8/5.0MM NOSEPIECE (H) STRUCTURAL | 1            | £10.72          |                       |
|                   | TSBL21637H00 *       | 6.4MM NOSEPIECE (J) M/BOLT         | 1            | £12.75          |                       |
|                   | TSBL21601H00 *       | 6.4MM NOSEPIECE (K) STRUCTURAL     | 1            | £10.72          |                       |
|                   | TSBZ41901H00         | FRONT SLEEVE ASSEMBLY              | 1            | £53.94          |                       |
|                   | TSBL43000H00         | PUSH PIN                           | 1            | £2.10           |                       |
|                   | TSBL42104H00         | PUSH PIN SPRING                    | 1            | £2.24           |                       |
|                   | TSBL43007H00         | MANDREL RELEASE TUBE               | 1            | £7.08           |                       |
|                   | TSBZ41905H00         | MANDREL RELEASE TUBE ASSY          | 1            | £7.08           |                       |
|                   | TSBZ41904H00         | GEAR BOX                           | 1            | £501.43         |                       |
|                   | TSBZ41924H00         | PCB                                | 1            | £311.43         |                       |
|                   | TSBZ41922H00         | BRUSHLESS MOTOR                    | 1            | £256.46         |                       |
|                   | TSBL23003H00         | RUBBER RING                        | 1            | £1.47           |                       |
|                   | TSBL42102H00         | CLAMPING SLEEVE                    | 1            | £26.90          |                       |
|                   | TSBZ41720H00         | SPRING SLEEVE                      | 1            | £12.61          |                       |
|                   | TSBL42118H00         | MANDREL COLLECTOR                  | 1            | £11.77          |                       |
|                   | TSBL42132H00         | CONTROL PANEL                      | 1            | £14.01          |                       |
|                   | TSBL43006H00         | PROTECTOR                          | 1            | £4.20           |                       |
|                   | TSBL23002H00         | SCREW COVER                        | 1            | £13.17          |                       |
|                   | TSBF60577H00         | SELF DRILL SCREW                   | 1            | £0.21           |                       |
| TSBZ41709H00      | BODY (BLUE)          | 1                                  | £74.61       |                 |                       |
| TSBZ41718H00      | BATTERY 18V-2.0A-36W | 1                                  | £140.11      | 2               |                       |
| TSBZ41734H00      | CHARGER UK ECP-BR-5A | 1                                  | £84.07       | 1               |                       |
| TSBL42162H00      | SPRING FOR TRIGGER   | 1                                  | £1.40        |                 |                       |
| TSBL42133H00      | TRIGGER              | 1                                  | £8.76        |                 |                       |
| TSBL42157H00      | SPANNER              | 1                                  | £3.08        | 1               |                       |

\* Spare order parts only



# BLIND RIVET NUT BATTERY TOOLS

JRPNB80A

|                   | Article Number | Description                      | Box Quantity | Price £ Per One | JRPNB80A Case Contents |
|-------------------|----------------|----------------------------------|--------------|-----------------|------------------------|
| TOOL              | JRPNB80A       | NB80A BATTERY RIVET TOOL (M3-M8) | 1            | £796.50         | 1                      |
| REPLACEMENT PARTS | TSBL43246H00   | M3 MANDREL                       | 1            | £13.66          | 1                      |
|                   | TSBL43245H00   | M4 MANDREL                       | 1            | £13.66          | 1                      |
|                   | TSBL43244H00   | M5 MANDREL                       | 1            | £13.66          | 1                      |
|                   | TSBL43243H00   | M6 MANDREL                       | 1            | £13.66          | 1                      |
|                   | TSBL43242H00   | M8 MANDREL                       | 1            | £13.66          | 1                      |
|                   | TSBL43252H00   | M3 HEAD                          | 1            | £11.56          | 1                      |
|                   | TSBL43251H00   | M4 HEAD                          | 1            | £11.56          | 1                      |
|                   | TSBL43250H00   | M5 HEAD                          | 1            | £11.56          | 1                      |
|                   | TSBL43249H00   | M6 HEAD                          | 1            | £11.56          | 1                      |
|                   | TSBL43248H00   | M8 HEAD                          | 1            | £11.56          | 1                      |
|                   | TSBZ41819H00   | GEAR BOX                         | 1            | £682.40         |                        |
|                   | TSBZ41876H00   | PCB                              | 1            | £564.22         |                        |
|                   | TSBZ41922H00   | BRUSHLESS MOTOR                  | 1            | £256.46         |                        |
|                   | TSBZ42050H00   | NOSEPIECE PEDESTAL               | 1            | £67.39          |                        |
|                   | TSBZ42078H00   | COVER TUBE                       | 1            | £12.61          |                        |
|                   | TSBZ41806H00   | GEARS ASSEMBLY                   | 1            | £24.31          |                        |
|                   | TSBL42296H00   | REAR COVER                       | 1            | £15.55          |                        |
|                   | TSBL42239H00   | CONTROL PANEL                    | 1            | £70.13          |                        |
|                   | TSBF60273H00   | HEX KEY                          | 1            | £3.71           | 1                      |
|                   | TSBL43232H00   | ADJUSTMENT NUT                   | 1            | £13.38          | 1                      |
|                   | TSBL23002H00   | SCREW COVER                      | 1            | £13.17          |                        |
|                   | TSBF60577H00   | SELF DRILL SCREW                 | 1            | £0.21           |                        |
|                   | TSBZ41709H00   | BODY (BLUE)                      | 1            | £74.61          |                        |
|                   | TSBZ41718H00   | BATTERY 18V-2.0A-36W             | 1            | £140.11         | 2                      |
|                   | TSBZ41734H00   | CHARGER UK ECP-BR-5A             | 1            | £84.07          | 1                      |
|                   | TSBL42162H00   | SPRING FOR TRIGGER               | 1            | £1.40           |                        |
| TSBL42133H00      | TRIGGER        | 1                                | £8.76        |                 |                        |
| TSBL42157H00      | SPANNER        | 1                                | £3.08        | 1               |                        |



| Technical Data             |  |
|----------------------------|--|
| Capacity                   | M3-M8  |
| Material Capabilities      | All Round Body, Semi and Full Hexagonal Blind Rivet Nuts in all Materials. |
| Motor Type                 | 18V Brushless Technology   |
| Vibration Magnitude        | 1.5m/s <sup>2</sup>  |
| Noise Level                | < 90dB   |
| Riveting Style             | Conventional Spin/Pull & Fully Automatic                                   |
| Traction Force             | 18000N   |
| Stroke Length (adjustable) | 6.0mm Max  |
| Weight (Net incl. battery) | 1.50kg   |

Watch our Battery Nut Tools video here

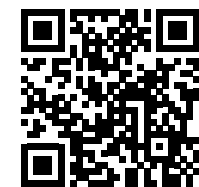

# BLIND RIVET NUT BATTERY TOOLS

JRPNB127A

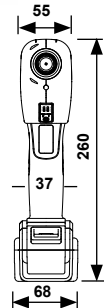
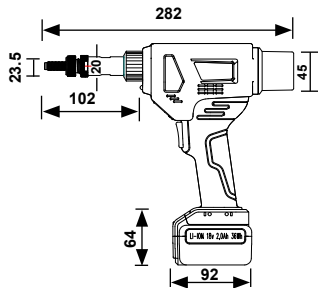

| Technical Data             |  |
|----------------------------|--|
| Capacity                   | M3-M12   |
| Material Capabilities      | All Round Body, Semi and Full Hexagonal Blind Rivet Nuts in All Materials. |
| Motor Type                 | 18V Brushless Technology   |
| Vibration Magnitude        | 1.5m/s <sup>2</sup>  |
| Noise Level                | < 90dB   |
| Riveting Style             | Conventional Spin/Pull & Fully Automatic                                   |
| Traction Force             | 27000N   |
| Stroke Length (adjustable) | 9.0mm Max  |
| Weight (Net incl. battery) | 1.64kg   |

Watch our Battery Nut Tools video here



|                   | Article Number       | Description                            | Box Quantity | Price £ Per One | JRPNB127A Case Contents |
|-------------------|----------------------|--|--------------|-----------------|-------------------------|
| TOOL              | JRPNB127A            | NB127A BATTERY RIVET NUT TOOL (M3-M12) | 1            | £1391.25        | 1                       |
| REPLACEMENT PARTS | TSBL43246H00         | M3 MANDREL                             | 1            | £13.66          | 1                       |
|                   | TSBL43245H00         | M4 MANDREL                             | 1            | £13.66          | 1                       |
|                   | TSBL43244H00         | M5 MANDREL                             | 1            | £13.66          | 1                       |
|                   | TSBL43243H00         | M6 MANDREL                             | 1            | £13.66          | 1                       |
|                   | TSBL43242H00         | M8 MANDREL                             | 1            | £13.66          | 1                       |
|                   | TSBL43241H00         | M10 MANDREL                            | 1            | £13.66          | 1                       |
|                   | TSBL43230H00         | M12 MANDREL                            | 1            | £13.66          | 1                       |
|                   | TSBL43252H00         | M3 HEAD                                | 1            | £11.56          | 1                       |
|                   | TSBL43251H00         | M4 HEAD                                | 1            | £11.56          | 1                       |
|                   | TSBL43250H00         | M5 HEAD                                | 1            | £11.56          | 1                       |
|                   | TSBL43249H00         | M6 HEAD                                | 1            | £11.56          | 1                       |
|                   | TSBL43248H00         | M8 HEAD                                | 1            | £11.56          | 1                       |
|                   | TSBL43247H00         | M10 HEAD                               | 1            | £11.56          | 1                       |
|                   | TSBL43231H00         | M12 HEAD                               | 1            | £11.56          | 1                       |
|                   | TSBZ42051H00         | GEAR BOX                               | 1            | £1,131.90       |                         |
|                   | TSBZ42076H00         | PCB                                    | 1            | £1,506.75       |                         |
|                   | TSBZ42074H00         | BRUSHLESS MOTOR                        | 1            | £512.98         |                         |
|                   | TSBZ42050H00         | NOSEPIECE PEDESTAL                     | 1            | £67.39          |                         |
|                   | TSBZ42078H00         | COVER TUBE                             | 1            | £12.61          |                         |
|                   | TSBZ41806H00         | GEARS ASSEMBLY                         | 1            | £24.31          |                         |
| TSBL42296H00      | REAR COVER           | 1                                      | £15.55       |                 |                         |
| TSBL42239H00      | CONTROL PANEL        | 1                                      | £70.13       |                 |                         |
| TSBF60273H00      | HEX KEY              | 1                                      | £3.71        | 1               |                         |
| TSBL43232H00      | ADJUSTMENT NUT       | 1                                      | £13.38       | 1               |                         |
| TSBL23002H00      | SCREW COVER          | 1                                      | £13.17       |                 |                         |
| TSBF60577H00      | SELF DRILL SCREW     | 1                                      | £0.21        |                 |                         |
| TSBZ41709H00      | BODY (BLUE)          | 1                                      | £74.61       |                 |                         |
| TSBZ41718H00      | BATTERY 18V-2.0A-36W | 1                                      | £140.11      | 2               |                         |
| TSBZ41734H00      | CHARGER UK ECP-BR-5A | 1                                      | £84.07       | 1               |                         |
| TSBL42162H00      | SPRING FOR TRIGGER   | 1                                      | £1.40        |                 |                         |
| TSBL42133H00      | TRIGGER              | 1                                      | £8.76        |                 |                         |
| TSBL42157H00      | SPANNER              | 1                                      | £3.08        | 1               |                         |



# BLIND RIVET BATTERY TOOL CAPACITY GUIDE

| Tool Model : JRPRB65   |                |       |          |          |        |
|--|----------------|-------|----------|----------|--------|
| Tool comes complete with<br>2.4, 3.0/3.2, 4.0 & 4.8/5.0mm Nosepieces |                |       |          |          |        |
| Diameter Size  | Rivet Material |       |          |          |        |
|  | Alum           | Steel | A2 St/St | A4 St/St | Copper |
| 2.4  |                | X     | X        | N/A      | N/A    |
| 3.0  |                |       |          |          |        |
| 3.2  |                |       |          |          |        |
| 4.0  |                |       |          |          |        |
| 4.8  |                |       |          |          |        |
| 5.0  |                |       |          |          | N/A    |
| 6.0  | X              | X     | X        | X        | N/A    |
| 6.4  | X              | X     | X        | X        | N/A    |

| Tool Model : JRPRB66   |                |       |          |          |        |
|--|----------------|-------|----------|----------|--------|
| Tool comes complete with<br>3.0/3.2, 4.0 & 4.8/5.0, 6.0 & 6.4mm Nosepieces |                |       |          |          |        |
| Diameter Size  | Rivet Material |       |          |          |        |
|  | Alum           | Steel | A2 St/St | A4 St/St | Copper |
| 2.4  |                | X     | X        | N/A      | N/A    |
| 3.0  |                |       |          |          |        |
| 3.2  |                |       |          |          |        |
| 4.0  |                |       |          |          |        |
| 4.8  |                |       |          |          |        |
| 5.0  |                |       |          |          | N/A    |
| 6.0  |                |       |          |          | N/A    |
| 6.4  |                |       |          |          | N/A    |

# BLIND RIVET NUT BATTERY TOOL CAPACITY GUIDE

| Tool Model : JRPNB80A  |                    |       |          |          |
|--|--------------------|-------|----------|----------|
| Tool comes complete with M3, M4, M5, M6 & M8<br>Mandrels & Heads |                    |       |          |          |
| Thread Size  | Rivet Nut Material |       |          |          |
|  | Alum               | Steel | A2 St/St | A4 St/St |
| M3   |                    |       |          |          |
| M4   |                    |       |          |          |
| M5   |                    |       |          |          |
| M6   |                    |       |          |          |
| M8   |                    |       |          |          |
| M10  | X                  | X     | X        | X        |
| M12  | X                  | X     | X        | X        |

| Tool Model : JRPNB127A   |                    |       |          |          |
|--|--------------------|-------|----------|----------|
| Tool comes complete with M3, M4, M5, M6, M8, M10 & M12<br>Mandrels & Heads |                    |       |          |          |
| Thread Size  | Rivet Nut Material |       |          |          |
|  | Alum               | Steel | A2 St/St | A4 St/St |
| M3   |                    |       |          |          |
| M4   |                    |       |          |          |
| M5   |                    |       |          |          |
| M6   |                    |       |          |          |
| M8   |                    |       |          |          |
| M10  |                    |       |          |          |
| M12  |                    |       |          |          |





# APPENDIX 1: TECHNICAL DATA - NUTS

(Standard By: GB/T17880.6-1999)

**Table 1: Axial Proof Load for Thread (Unit:N)**

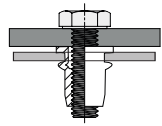

| Blind Rivet Nut                                    | Mechanical Characteristics |                       | Thread Size |      |       |       |       |       |       |
|--|----------------------------|-----------------------|-------------|------|-------|-------|-------|-------|-------|
|  |                            |                       | M3          | M4   | M5    | M6    | M8    | M10   | M12   |
| Round and Hex, Flat and (Reduced) countersunk head | Proof Load                 | Steel/Stainless Steel | 3900        | 6800 | 11500 | 16500 | 25000 | 32000 | 34000 |
|  |                            | Aluminium             | 1900        | 4000 | 6500  | 7800  | 12300 | 17500 | -     |

**Table 2: Broken Torque (Unit:N.m)**

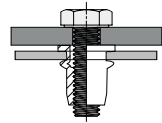

| Thread Size   | M3  | M4  | M5  | M6 | M8 | M10 | M12 |
|---|-----|-----|-----|----|----|-----|-----|
| Steel/Inox<br>Flat head, round and hex                | 2   | 5   | 8.5 | 15 | 26 | 50  | 80  |
| Steel/Inox<br>Countersunk head, round and hex         | 1   | 4   | 8   | 15 | 26 | 45  | 70  |
| Steel/Inox<br>Reduced head, round and hex             | 1   | 3   | 6   | 11 | 20 | 32  | 50  |
| Aluminium Flat and reduced (counter) head, round body | 0.7 | 2.5 | 5   | 8  | 20 | 25  | -   |

**Table 3: Turning Torque for Clamping Force (Unit:N.m)**

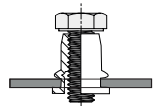

| Thread Size                                | M3   | M4  | M5  | M6  | M8  | M10 | M12 |
|--|------|-----|-----|-----|-----|-----|-----|
| Steel/Inox<br>Flat head, round body        | 0.5  | 1   | 2   | 4.5 | 5.5 | 11  | 30  |
| Steel/Inox<br>(Reduced) counter head round | 0.4  | 0.8 | 1.5 | 3.5 | 4.5 | 8.5 | 24  |
| Aluminium<br>Flat head, round body         | 0.25 | 0.9 | 1.5 | 3.5 | 5   | 6.5 | 21  |
| Aluminium<br>(Reduced) counter, round body | 0.2  | 0.7 | 1.2 | 2.5 | 4   | 5   | 16  |

**Table 4: Shearing Strength (Unit:N)**

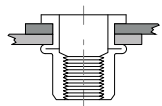

| Blind Rivet Nut                                    | Mechanical Characteristics |                       | Thread Size |      |      |      |      |      |      |
|--|----------------------------|-----------------------|-------------|------|------|------|------|------|------|
|  |                            |                       | M3          | M4   | M5   | M6   | M8   | M10  | M12  |
| Round and Hex, Flat and (Reduced) countersunk head | Shearing                   | Steel/Stainless Steel | 900         | 1500 | 2000 | 3000 | 4400 | 5000 | 6500 |
|  |                            | Aluminium             | 600         | 1000 | 1200 | 2000 | 2400 | 3800 | -    |

1. Steel for C1008 2. Stainless Steel for ANSI304 3. Aluminium for AlMg2.5  
Data for reference purposes only. For exact values independent physical tests should be carried out.

# CUSTOMER SUPPORT MATERIALS

## A range of marketing support exclusively for our distributors.

As a stockist of JRP products we are here to support you. Our range of marketing support materials includes branded wall stickers, posters and banners suitable for internal and external displays.

For more information, speak to your Area Sales Manager.

### WINDOW STICKERS

Help your store stand out with our branded window sticker.

| BRAND | SIZE          |
|-------|---------------|
| JRP   | 200mm x 100mm |



### OUTDOOR BANNERS

Our branded banners are ideal for eye-catching indoor and outdoor advertising. PVC-free, they are fully recyclable and an environmentally friendly alternative to PVC banners.

| BRAND | SIZE           |
|-------|----------------|
| JRP   | 2000mm x 600mm |



### PRINTED AND DOWNLOADABLE POSTERS



JRP



JRP Rivets

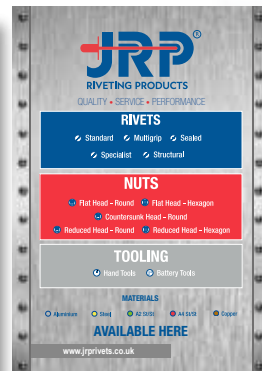

JRP Range

A range of branded posters showcasing features, benefits and range highlights. Ideal for advertising in-store. Can be put into an existing frame or fixed to the wall. All posters are available for instant download.

| BRAND      | SIZE                           |
|------------|--------------------------------|
| JRP        | Printed A1 - Download A1 or A3 |
| JRP Rivets | Download A1 or A3              |
| JRP Range  | Download A1 or A3              |

Download here





# TERMS AND CONDITIONS OF SALE

## 1. APPLICATION

Unless otherwise agreed in writing between the company and its customer, the following terms and conditions of sales shall apply to all sales of goods by the company to its customer.

## 2. PRICE VARIATION

Price applicable to the sales of goods by the company to the customer shall be the price ruling at the date of despatch. The company therefore reserves the right to amend prices quoted at the date of the placing of an order by the customer by notifying the customer in writing.

## 3. CARRIAGE

The Company reserves the right as part of this contract to impose such surcharge or carriage charge as shall be laid down by the company policy at any time. Such terms will be available for examination at the address of the company shown on the letterhead of its invoices and are deemed to be part of all contracts unless specifically agreed to the contrary in writing by the company. The company has sole choice of method of delivery and of carrier or carriers employed unless specifically agreed in writing to the contrary.

## 4. DESPATCH

Despatch dates are quoted without engagement although every endeavour will be made to adhere to the date or dates quoted. In no circumstances shall the company be liable for any loss arising from delay in despatch however caused. Time shall not be of the essence of the contract.

## 5. DAMAGE AND LOSS IN TRANSIT

5.1 The company accepts no liability for any damage to goods in transit unless notified to the company and the carrier concerned within twenty four hours after delivery.

5.2 In the case of non-delivery the company accepts no liability of any sort unless written notice of non-delivery is given to the company within seven days after the date of the advice of despatch of the goods.

5.3 Paragraphs one and two shall not apply to despatches to countries outside the United Kingdom of Great Britain, Northern Ireland and the Isle of Man. In respect of these countries the company accepts no liability for damage or loss in transit unless the company has contracted to supply the goods C.I.F. and the customer has adhered to the terms of the insurance policy.

5.4 The company's liability for damage in transit or non-delivery of goods duly notified to it in accordance with the above, shall in any event be limited solely to replacement of the goods within a reasonable time, whether non-delivery or damage is due to the company's negligence or otherwise.

## 6. CLAIMS

Subject to the provision of condition 5, all claims for goods alleged to be defective must be made in writing to the company within seven days after the date of delivery. When notification is so received the company may require return of the goods or for the goods to be made available for inspection by the company. Should the company be satisfied as to the defects then it retains the option to either replace the defective goods within a reasonable time or credit to the customer within the contract price. All defective goods so returned shall be the property of the company. Except as provided above, the company shall have no liability whatsoever arising out of any agreement to sell or sale of goods including claims for direct consequential or other loss, damage or expense, whether arising or alleged to arise under any warranty statement, conditional term expressed or implied, statutory or otherwise, or in negligence or alleged negligence on the part of the company or otherwise. In no circumstances shall the company be liable for loss or damage in excess of the contract sale price.

## 7. PASSING OF PROPERTY

Each of the following sub-clauses 7.1 to 7.6 are separate and severable and shall be enforceable accordingly:

7.1 Notwithstanding delivery, all goods supplied by us will remain our absolute property until you pay in full for them and for all other goods previously supplied by us;

7.2 You will store the goods in such a way that they are readily identifiable as our property, but you may, as trustees for us, sell them to a third party in the normal course of your business;

7.3 Upon any sale by you of the goods (either alone or with other items) all rights which you have against the buyer shall automatically vest in us;

7.4 We shall be entitled immediately after giving notice of our intention to repossess, to enter upon any premises with such transport as may be necessary and repossess any goods to which we have title under this Clause;

7.5 If you incorporate the goods we supply to you into other products with or without materials you already possess or which are supplied to you by third parties the property in such other product will pass to us and you shall store them without charge on our behalf as bailee;

7.6 You shall not be entitled to pledge or in any way charge by way of security any of the goods which remain our property but in the event you do so all moneys owing by you to us shall without prejudice to any other right or remedy available to us forthwith become due and payable.

## 8. PAYMENT

For the purpose of this Clause the due date shall mean the due date specified on the face of the invoice. Customers electing to pay by Direct Debit shall mean the 28th of the month following the month of the invoice. If you do not comply punctually with these terms of payment we reserve the right to charge you interest on any amount overdue at the rate of 1½% per month from the due date to the date of receipt of the monies outstanding, and without notice to suspend further deliveries until all arrears (including interest) have been paid and, at our option, to rescind any subsisting contract with you as to all or any parts of future deliveries but without prejudice to any rights already accrued to us under such contracts. Where a settlement discount is shown on the face of the invoice the customer may deduct this from his payment provided that payment in full less this discount is made by the due date.

## 9. ADDITIONAL DELIVERIES

Where the company has been obliged to make an additional delivery of the goods to the premises specified in the contract due to the failure of the customer to accept the delivery of the goods, the company reserves the right to make a charge for such additional delivery, unless the company failed to meet a specified time and date of delivery agreed in writing by the company and the customer. Any proposed delivery date specified on this invoice or on a sales order does not constitute such agreement in writing.

## 10. INTERPRETATION

Any agreement between the company and the purchaser shall be subject to and governed by the domestic law of England.

## SALES OFFICES

### Dartford

Tel 01322 277733  
dartford.sales@owlett-jaton.com

### Elland

Tel 01422 370121  
elland.sales@owlett-jaton.com

### Milton Keynes

Tel 01908 201600  
milton.keynes@owlett-jaton.com

### Stone

Tel 01785 819819  
info@owlett-jaton.com

### Swindon

Tel 01793 527829  
swindon.sales@owlett-jaton.com



[www.jrprivets.co.uk](http://www.jrprivets.co.uk)

### HEAD OFFICE

Opal Way, Stone Business Park, Stone, Staffordshire, ST15 0SW  
Tel: 01785 811300  
[www.owlett-jaton.com](http://www.owlett-jaton.com)

