



CATALOGUE

2024



L • A • H
SUPPLIES LTD



WELCOME TO JCP

OVER 20 YEARS OF FIXING EXPERTISE

JCP Construction Products is a leading supplier of high-quality construction fixings exclusively to the distributor. Established in 2001, we have grown to be a leading force in the UK fixings market, offering unrivalled technical support. The specialist fixings division of Owlett-Jaton, JCP supplies a wide range of anchoring products for use within the construction industry.



OUR COMMITMENT TO STOCK MEANS PRODUCTS ARE AVAILABLE, COMPETITIVELY PRICED, FOR NEXT-DAY DELIVERY THROUGHOUT MOST OF THE UK MAINLAND.

Supplying fixings to suit a variety of applications, JCP products come with full technical specification and include CE and ETA certified ranges. With quality and technical support underpinning JCP's approach, continual innovation ensures our range of products meets the ever-changing demands of the industry.

Our highly trained field representatives offer on-site testing throughout the UK, to demonstrate the suitability of our products.



FREE, NEXT-DAY DELIVERY WITH LOW MINIMUM ORDER LEVELS ACROSS THE MAJORITY OF THE UK MAINLAND.

www.jcpfixings.co.uk

To provide fast and easy access to the technical data for the JCP range, we have added QR codes to each of the ranges for your convenience.

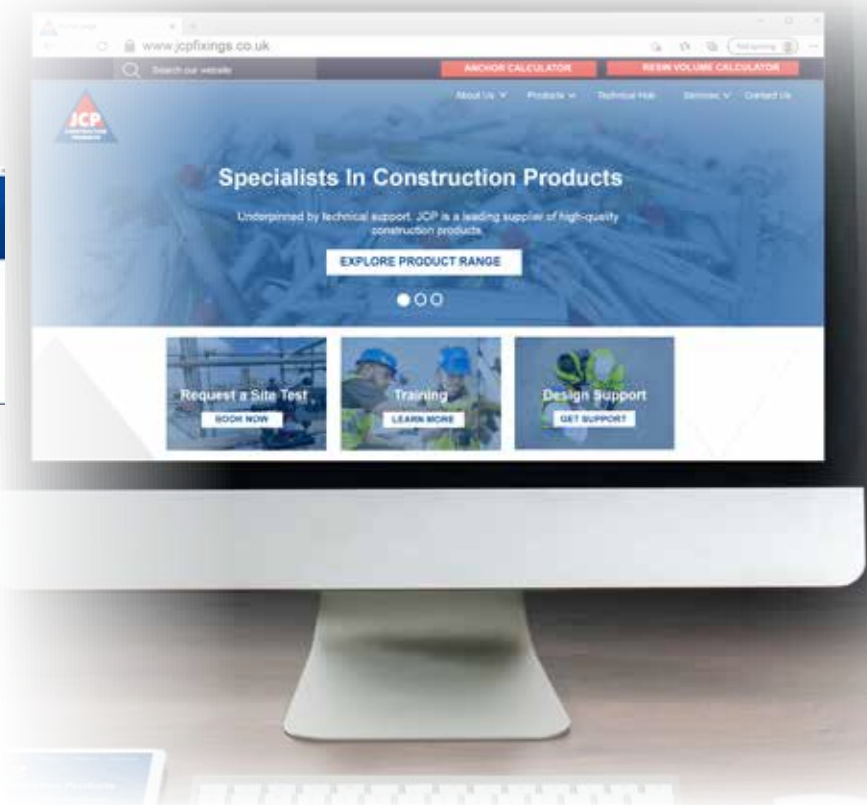
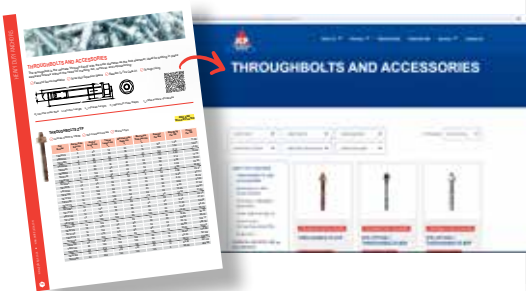

The JCP website is easy to navigate and provides the technical information required to help our customers, the distributors, to support their customers.

For end-users, technical help can be requested at the click of a button. Installers can easily download data sheets and view installation information on-site. Whilst arranging on-site support, design support, or training has never been as easy.

ANCHOR CALCULATION PROGRAM

The Anchor Calculation Program provides solutions for anchoring into both cracked and non-cracked concrete. The tool is designed for engineers, specifiers and architects to simplify specifying connections to surfaces such as floors, ceilings and walls, and takes into account loadings, spacing and edge distances. It includes 3D graphics, along with hole depth optimisation for chemical anchors.

Developed by our Technical Department, the JCP Anchor Specification Program also includes a rebar calculator, making it now a 'Suite' of programs. The two programs together, the ACP and Rebar calculator offer choice as to which one works best for the project being worked on.

The program can perform the structural analysis for numerous configurations of fixings for different base plate geometries. Calculations can be carried out in accordance with EN1992-4 covering the design of fasteners under static, quasi static and seismic actions, as well as fire exposure. Users have the option to choose the EOTA Guideline and Technical Report relative to the design of anchors in concrete as the design standard.

The software and database are updated regularly to ensure the program is compliant with any changes in legislation or industry standards.

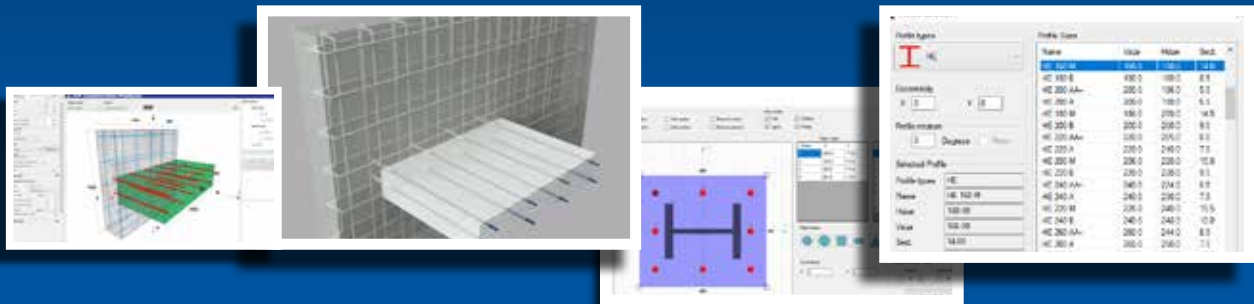

The JCP Anchor Calculation Program is free to download via www.jcpfixings.co.uk



RESIN CALCULATOR

“ Our free resin calculator helps to calculate the volume of resin required for a project based on the number of holes, anchor diameters and embedment depth. It is suitable for rebar and threaded bars. ”



THE RESIN CALCULATOR IS FREE TO DOWNLOAD VIA www.jcpfixings.co.uk

Our sales offices are open Monday to Thursday 8.30 am to 5.30 pm and 8.30 am to 5.00 pm on Fridays.
Account-holders can order online - 24 hours a day, 7 days a week from www.owlett-jaton.com





TECHNICAL SUPPORT



ON-SITE SUPPORT

Throughout the UK we offer on-site testing of our products by our highly experienced field representatives. Whether a building regulation requirement or for peace of mind, we will provide advice on behalf of a distributor. On-site pull out tests are part of the JCP culture.

In addition, our technical support team can provide a troubleshooting technical back up when required.

“ Highly experienced, our technical support team have many years of knowledge within the industry and can be relied on to offer guidance when required. ”

BACKED BY TECHNICAL KNOW-HOW AND EXPERIENCE

Further technical information, specifications, anchor calculations etc. are also available via our technical helpline.

In-depth technical support comes as standard with JCP.

TECHNICAL DATA LIBRARY

Datasheets can be found on the JCP website for products within the range. The data sheets provide detailed information on the following; where applicable.

- ✔ Product information
- ✔ Load and range data
- ✔ Performance data
- ✔ Installation instructions
- ✔ Features
- ✔ Base material guidance
- ✔ Related products

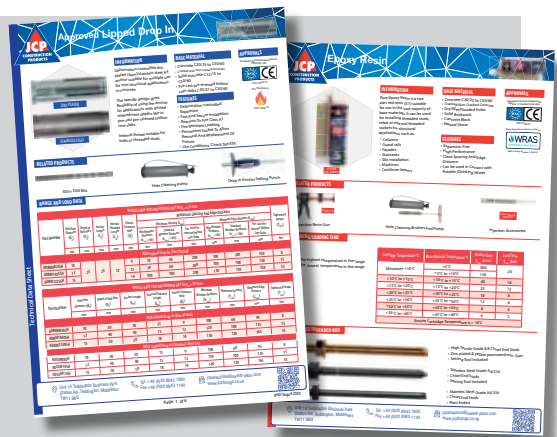



TRAINING

Our technical team offer training sessions to provide a hands-on-experience with our fixings. Sessions are tailored to meet the needs of the audience enabling you to navigate through the software interface, enter project-specific data, and interpret results with practical exercises and real-world case studies.

Who Should Attend?



Construction Professionals



Civil and Structural Engineers



Architects

Courses are delivered in two versions:

BASIC TRAINING

What you'll learn:

- Introduction To JCP
- Different Anchor Types Within The JCP Range
- How To Design And Assess Fasteners
- Codes And Regulations
- Design Methods
- ACP Introduction
- Simple Example
- Anchor Selection And Calculation Report



2-3 Hours



Online Or In Person



Free

ADVANCED TRAINING

What you'll learn:

- Introduction To JCP
- Anchor Types Within The JCP Range
- How To Design And Assess Fasteners
- Different Failure Modes In Concrete
- Different Failure Modes In Masonry
- Codes And Regulations
- CE Marking, EADS And ETAS
- Design Methods
- ACP Introduction
- Simple Example
- Anchor Selection And Calculation Report

- Advanced ACP Features including Custom Geometry, Lever Arm, Depth Optimisation, Load Combinations, Fire Design, Seismic Design and Reinforcement

- Result Interpretation And Design Optimisation
- Installation Practices
- Job-Site Tests Regimes For Anchors



5-6 Hours



Online Or In Person



Free



NEW PRODUCTS FROM JCP

“Introducing new products to the range underlines our commitment to mirroring the ever-changing demands of the construction industry and, ultimately, the needs of our customers.”



ETA PAN HEAD ANKERBOLTS

PAGE 23

BI-METAL A4 STAINLESS STEEL AND ALLOY STEEL

The ankerbolt is a self-tapping anchor for use in a variety of base materials, with the self-tapping action providing a positive anchorage in non-cracked concrete, brick, stone, and blocks.

- ✓ Concrete C20/25 To C50/60
- ✓ Cracked Concrete
- ✓ Non-Cracked Concrete
- ✓ Bi-Metallic
- ✓ Carbon Steel Tip With Leading Threads To Cut Into Concrete
- ✓ ETAG 001-6
- ✓ Fire Resistance Loading
- ✓ Suitable For External Use And Marine Environments



MASONRY SCREWS

PAGE 23

BI-METAL A4 STAINLESS STEEL

A high-quality, self-tapping screw which speeds up installation time, enables thread cutting, and avoids corrosion.

- ✓ Super Fast
- ✓ Efficient Thread Cutting
- ✓ Excellent Corrosion Resistance



ETA DROP-IN ANCHORS BZP

PAGE 26

A deformation-controlled internally threaded socket anchor suitable for multiple use.

- ✓ Concrete C20/25 To C50/60
- ✓ Non-Cracked Concrete
- ✓ Minimum 5µm



THE FULL JCP RANGE IS AVAILABLE TO ORDER FROM WWW.OWLETT-JATON.COM



ETA LIPPED DROP-IN ANCHORS BZP

PAGE 27

A deformation-controlled internally threaded socket anchor suitable for multiple use. The anchor can be accurately set independent of the hole depth, preventing the anchor from being inserted too far. The internal thread is suitable for bolts or threaded studs.

- ✓ Concrete C20/25 To C50/60
- ✓ Non-Cracked Concrete
- ✓ Minimum 5µm



INJECTION RESIN TOOL - JTOOL410

PAGE 46

For use with the J-Fix injection resin systems.

- ✓ Easy-To-Use
- ✓ Hand Operated
- ✓ Compatible With Other Resins
- ✓ For Any 410ml Cartridge



WOODFIX HIGH-THREAD SELF-DRILLING SCREWS FOR TIMBER BZP

PAGE 64

- ✓ For Fixing Composite Panels To Wood
- ✓ DIN 7504P
- ✓ C1022 Steel Case Hardened
- ✓ Minimum 8µm



FIBRE CEMENT SCREWS FOR TIMBER WITH BLACK WASHER

PAGE 66

- ✓ For Fixing Fibre Cement Profiles To Steel
- ✓ Supplied With Washer For Watertight Fixing
- ✓ Reamer On Shank Makes A Clearance To Allow Sheet Expansion And Contraction
- ✓ BZP Screw
- ✓ A2 Stainless Steel Black Washer



PLASTIC COATED FIXING BANDS

PAGE 77

For general strapping applications available in both straight and round formats, supplied in rigid plastic dispensers for ease of use.

- ✓ Easy To Cut
- ✓ Easy To Dispense
- ✓ Various Hole Configurations
- ✓ Stainless Steel For External Use

CONTENTS

HEAVY DUTY ANCHORS

THROUGHBOLTS AND ACCESSORIES

Throughbolts	14
Wirehangers	18
Nail In Sockets	18

ANKERBOLTS AND ACCESSORIES

Ankerbolts	19
Ankerbolt Drop In	23
Masonry Screws	23
Socket Bolts	24
Hook and Eye Bolts	24

INTERNAL THREADED ANCHORS

Drop In Anchors	25
Drop In Anchor Setting Punches	28
Stop Drill Bits	28

HOOK AND EYE BOLTS

Forged Hook Bolts	29
Forged Eye Bolts	29
Scaffold Ring Bolts	30
Scaffold Retaining Eyes	30
Scaffold Eye Plugs	30

HEAVY DUTY EXPANSION ANCHORS

Heavy Duty Anchors	31
--------------------------	----

BLIND BOLTS

Blind Bolts	34
-------------------	----

CHEMICAL ANCHORS AND ACCESSORIES

INJECTION RESINS AND GLASS CAPSULES

J-Fix Pure Epoxy Resin	38
J-Fix Ultra Bond 100 Epoxy Resin	38
J-Fix Vinylester Resin	39
J-Fix Vinylester Fast Cure Resin	39
J-Fix Epoxy Acrylate Resin	40
J-Fix Polyester Styrene Free Resin	40
J-Fix Polyester Resin	40
J-Fix Spin In Glass Capsules	41
J-Fix Hammer In Glass Capsules	41

ANCHORING CEMENTS

Rockite	41
Kwixset	42

THREADED STUDS AND SOCKETS

J-Fix Studs	42
Injection Resin Sockets	45
Internal Threaded Sockets	45

INJECTION RESIN ACCESSORIES

Injection Tools	46
Injection Tool Accessories	46
Nylon Sleeves	47
Wire Mesh Sleeve	47
Wire Cleaning Brushes	47
Blow Out Pump	47

CRACK STITCHING ACCESSORIES

Crack Stitch Twist Starter Kit	48
Pointing Gun	48
Mixing Paddle	48
Stitching Bar	49
Cementitious Grout	49

PU FOAMS AND ACCESSORIES

B3 Expanding Foam	49
B2 Expanding Foam	50
B1 Fire Stop Expanding Foam	50
Intumescent and Acoustic Mastic	51
Polyurethane Cleaner	51
Applicator Guns	51

MEDIUM DUTY ANCHORS

SLEEVE ANCHORS

Sleeve Anchors	52
----------------------	----

SHIELD ANCHORS

Shield Anchors	55
----------------------	----

CONCRETE SCREWS

Concrete Screws	57
-----------------------	----

SELF-DRILLING SCREWS

SELF-DRILLING SCREWS BZP

Metalfix	59
Woodfix	62
Metalfix Gash Point Screws	62
Metalfix Stitching Screws	63
Metalfix High Thread Screws	63
Woodfix High-Thread Screws	64
Metalfix Low Profile Screws	64
Wafer Head Screws	65
Metalfix Magnetic Sockets	65
Fibre Cement Screws	65

SELF-DRILLING SCREWS A2 STAINLESS STEEL

Metalfix	66
Woodfix	67
Metalfix Stitching Screws	68

COVER CAPS

Coloured Cover Caps	68
---------------------------	----

INTERNAL THREADED SELF-DRILLING SCREWS

Vertical Hangers	69
Horizontal Hangers	69
Gash Point Vertical Hangers	70
Gash Point Horizontal Hangers	70
Setting Tool	70

LIGHT DUTY FIXINGS

NAIL IN ANCHORS

Nail In Anchors	71
-----------------------	----

CONSTRUCTION NAILS

Plastic Headed Nails	72
Masonry Nails	72

SANITARY FIXINGS

Basin Fixings	73
W.C Fixings	74

BRACKETS

Vertical Flange Clips	74
Angle Brackets	74

WALL SCREWS

Wall Screws	75
-------------------	----

BIGTWIST NAILS

Bigtwist Nails	76
----------------------	----

FIXING BANDS

Fixing Bands	77
--------------------	----

NYLON AND CAVITY FIXINGS

NYLON HAMMER SCREWS

Nylon Hammer Screws	78
---------------------------	----

NYLON FRAME FIXINGS

Nylon Frame Fixings	80
---------------------------	----

PLUGS

Push Plugs	82
------------------	----

Nylon Wall Plugs	82
------------------------	----

Plastic Plugs	83
---------------------	----

Metal Expansion Plugs	84
-----------------------------	----

CAVITY FIXINGS

J-Plug Plasterboard Fixings	85
-----------------------------------	----

Rosett Cavity Fixings	85
-----------------------------	----

Ankernuts	86
-----------------	----

Road Fixing Kit	86
-----------------------	----

Hollow Wall Anchors	87
---------------------------	----

Hollow Wall Anchor Setting Tool	87
---------------------------------------	----

Spring Toggles	87
----------------------	----

Plastic Toggles	88
-----------------------	----

PA AND GAS

GAS NAILS

Drivefast Gas Nails	89
---------------------------	----

Brad Nails and Gas	90
--------------------------	----

CARTRIDGE TOOLS AND ACCESSORIES

Ceiling Hangers	91
-----------------------	----

PA97 Cartridge Tool Kit	91
-------------------------------	----

Cartridge Strips	91
------------------------	----

Shot Fired Pins	92
-----------------------	----

Plastic Washered Pins	92
-----------------------------	----

Magazine Pins	92
---------------------	----

DRILL BITS

DRILL BITS

SDS Drill Bits	93
----------------------	----

SDS Drill Bit Sets	95
--------------------------	----

Masonry Drill Bits	95
--------------------------	----

Masonry Drill Bit Sets	95
------------------------------	----

HSS Drill Bits	96
----------------------	----

HSS Reduced Shank Drill Bits	97
------------------------------------	----

HSS Long Shank Drill Bits	98
---------------------------------	----

HSS Drill Bit Cases	98
---------------------------	----

HSS Countersink Drill Bits	98
----------------------------------	----

Cobalt Countersink Drill Bits	99
-------------------------------------	----

Tungsten Carbide Drill Bits	99
-----------------------------------	----

Auger Drill Bits	99
------------------------	----

Flat Wood Bits	100
----------------------	-----

Centre Spur Wood Bits	100
-----------------------------	-----

Torx Driver Bits	100
------------------------	-----

RETAIL BAG RANGE

HEAVY DUTY

Throughbolts	105
--------------------	-----

Ankerbolts	105
------------------	-----

Hook and Eye Bolts	106
--------------------------	-----

Sleeve Anchors	106
----------------------	-----

MEDIUM DUTY

Drop In Anchors	106
-----------------------	-----

Shield Anchors	107
----------------------	-----

Concrete Screws	107
-----------------------	-----

NYLON AND CAVITY

Nylon Hammer Screws	108
---------------------------	-----

Nylon Frame Fixings	108
---------------------------	-----

Wall Plugs	108
------------------	-----

Premium Plastic Plugs	109
-----------------------------	-----

J-Plug Plasterboard Fixings	109
-----------------------------------	-----

Rosett Cavity Fixings	109
-----------------------------	-----

Plasterboard Plugs	109
--------------------------	-----

Hollow Wall Anchors	110
---------------------------	-----

Spring Toggles	110
----------------------	-----

Plastic Toggles	110
-----------------------	-----

SELF-DRILLING SCREWS

Plastic Headed Nails	111
----------------------------	-----

Masonry Nails	111
---------------------	-----

Sanitary Fixings	111
------------------------	-----

Wall Screws	112
-------------------	-----

Bigtwist Nails	112
----------------------	-----

Metalfix Self-Drilling Screws	112
-------------------------------------	-----

Woodfix Self-Drilling Screws	113
------------------------------------	-----

Metalfix Gash Point Screws	114
----------------------------------	-----

Metalfix Stitching Screws	114
---------------------------------	-----

Wafer Head Self-Drilling Screws	114
---------------------------------------	-----

Metalfix Magnetic Sockets	114
---------------------------------	-----

TRADE BAG RANGE

HEAVY DUTY

Throughbolts	115
--------------------	-----

Ankerbolts	115
------------------	-----

MEDIUM DUTY

Shield Anchors	116
----------------------	-----

Concrete Screws	116
-----------------------	-----

NYLON AND CAVITY

Nylon Hammer Screws	116
---------------------------	-----

Nylon Frame Fixings	117
---------------------------	-----

Nylon Wall Plugs	117
------------------------	-----

J-Plug Metal Plasterboard Fixings	117
---	-----

Rosett Cavity Fixings	117
-----------------------------	-----

Hollow Wall Anchors	117
---------------------------	-----

SELF-DRILLING SCREWS

Wall Screws	118
-------------------	-----

Metalfix Self-Drilling Screws	118
-------------------------------------	-----

Woodfix Self-Drilling Screws	119
------------------------------------	-----

Metalfix Gash Point Screws	119
----------------------------------	-----

Metalfix Stitching Screws	119
---------------------------------	-----

Merchandising Solutions	120
-------------------------------	-----

Customer Support	122
------------------------	-----

Notes	123
-------------	-----

Index	124
-------------	-----



PRODUCT FINDER

Product	Page No.	Non-Cracked Concrete	Cracked Concrete	Stone	Dense Concrete Blocks-Solid	Solid Brickwork	Perforated Brickwork	Light Aggregate Block-Solid	Light Aggregate Block-Hollow	Aerated Concrete Blocks-Solid	Hollow Concrete Planks	Hollow Clay Pats	Plasterboard	Solid Steel	Hollow Steel Section	Timber
Throughbolts ZYP	14	●			●											
Throughbolts Option 1 BZP	15	●	●		●											
Throughbolts Option 7 BZP	15	●			●											
Throughbolts Hot Dipped Galv	16	●			●											
Throughbolts A2 Stainless Steel	16	●			●											
Throughbolts Option 1 A4 Stainless Steel	17	●	●		●											
Throughbolts Option 7 A4 Stainless Steel	17	●			●											
Wire Hangers	18	●			●											
Nail In Sockets	18	●			●											
Ankerbolts	19	●		●	●	●		●			●					
Ankerbolts Option 1 BZP	20	●	●	●	●	●		●			●					
Ankerbolts A4 Stainless Steel	22	●		●	●	●		●			●					
Drop In Anchors ZYP	25	●														
Approved Drop In Anchors BZP	25	●	●		●											
Lipped Drop In Anchors ZYP	26	●									●					
Drop In Anchors A4 Stainless Steel	26	●														
Approved Lipped Drop In Anchors BZP	27	●			●						●					
Lipped Drop In Anchors A4 Stainless Steel	27	●	●		●						●					
Scaffold Eye and Plugs	30	●		●	●	●		●								
Heavy Duty Anchors	31	●	●													
Blind Bolt	34													●	●	
J-Fix Epoxy Resin	38	●	●	●	●	●		●		●						
J-Fix Vinylester Resin	39	●	●	●	●	●		●		●						
J-Fix Epoxy Acrylate Resin	40	●		●	●											
J-Fix Polyester Styrene Free Resin	40			●	●	●	●	●	●	●	●	●				
J-Fix Polyester Resin	40			●	●	●	●	●	●	●	●	●				
Spin In Capsules	41	●														
Hammer In Capsules	41	●														
Rockite (Interior)	41	●			●											
Kwikset (Exterior)	42	●			●											
J-Fix Injection Resin Sleeve	47						●		●		●	●				
Crack Stitching	48					●	●	●	●	●						

Full Suitability ● More Suitable Alternative Available ●

Product	Page No.	Non-Cracked Concrete	Cracked Concrete	Stone	Dense Concrete Blocks-Solid	Solid Brickwork	Perforated Brickwork	Light Aggregate Block-Solid	Light Aggregate Block-Hollow	Aerated Concrete Blocks-Solid	Hollow Concrete Planks	Hollow Clay Pots	Plasterboard	Solid Steel	Hollow Steel Section	Timber
Sleeve Anchors	52	●		●	●	●										
Shield Anchors	55	●			●	●	●	●	●	●	●		●			
Concrete Screws	57	●		●	●	●	●									
Self Drilling Screws	59													●	●	
Gash Point Screws	62															●
Nail In Anchors	71	●			●											
Masonry Nails	72					●	●	●								
Plastic Headed Nails	72					●	●	●								
Sanitary Fixings	73	●			●	●		●								
Wall Screws	75	●			●	●	●	●	●	●	●		●			
Bigtwist Nails	76															●
Hammerscrews	78	●		●	●	●	●	●	●							
Nylon Frame Fixings	80	●		●	●	●		●	●							
Approved Frame Fixings	80	●	●	●	●	●	●	●	●	●						
Nylon Plugs	82	●		●	●	●	●	●	●	●	●					
Plastic Plugs	83	●		●	●	●	●	●	●	●	●					
Metal Plugs	84									●						
J-Pug Plasterboard Fixings	85												●			
Rosett Cavity Fixings	85											●	●			
Ankernuts	86	●					●		●			●	●			
Hollow Wall Anchors	87												●			
Spring Toggles	87												●			
Plastic Toggles	88												●			
Drivefast Nails	89															●
Powder Actuated Drive Pins	92	●			●	●								●	●	

Full Suitability ● More Suitable Alternative Available ●

www.jcpfixings.co.uk

Our sales offices are open Monday to Thursday 8.30 am to 5.30 pm and 8.30 am to 5.00 pm on Fridays.

Account-holders can order online - 24 hours a day, 7 days a week from www.owlett-jaton.com

THE CERTIFIED RANGE

“ The JCP range includes numerous certified products to support installers in meeting building specification requirements. ”



PROVIDING PEACE OF MIND

Look for these symbols alongside the products to easily identify which they are.



CE - indicates the product conforms with harmonised standards within the European Economic Area.



Seismic C1 + C2 - relates to anchors which are rated for use in concrete under seismic actions. C2 is the most stringent category. To qualify as C1 and /or C2 anchors must comply with EN1992-4 or TR045.



Fire resistance - offers fire resistance loading.



ETA Option 1 - anchors which have been approved for use in cracked and non-cracked concrete. They can be used for safely supporting applications in area's most vulnerable to cracking.



ETA Option 7 - versatile anchors approved for use in non-cracked concrete. They are very versatile for concretes with a strength class over 20/25.



WRAS - approved for use in contact with potable (drinking) water.

Please see page 119 for further information on the implementation of UKCA for construction products.



THROUGHBOLTS

PAGE 14

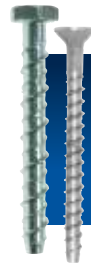

ANKERBOLTS

PAGE 20



DROP IN ANCHORS

PAGE 25



HEAVY DUTY ANCHORS

PAGE 31



INJECTION RESINS

PAGE 38



NYLON FRAME FIXINGS

PAGE 80

CRACKED CONCRETE PRODUCTS

ETA Option 1 Throughbolts
BZP & Stainless Steel
Pages 15 & 17

ETA Ankerbolt Option 1
BZP & Stainless Steel
Pages 20 & 22

ETA Drop In Anchors
BZP & Stainless Steel
Pages 25-27

Heavy Duty Anchors
Pages 31-33

Resins - Pure Epoxy,
Ultrabond, Vynylester
Pages 38-40

ETA Frame Fixings
BZP & Stainless Steel
Pages 80-81



The Product Range

- ✔ Over 1,800 Products
- ✔ Technical Drawings
- ✔ Features and Benefits



THROUGHBOLTS AND ACCESSORIES

The throughbolt is the ultimate 'through fixing' with the hole diameter as the bolt diameter, ideal for bolting in place awkward fixtures without the need for marking out, removal, and repositioning.

- Fast And Secure Installation
- Three Way Expansion Sleeve
- Reaction To Fire Class A1
- Through Fixing

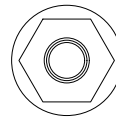
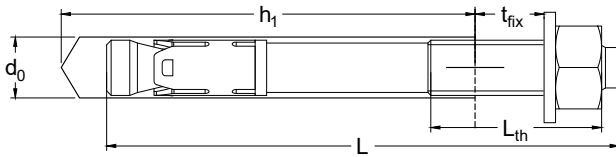

d_0 =Anchor Hole Size L =Anchor Length L_{th} =Thread Length h_1 =Minimum Hole Depth t_{fix} =Max Fixture Thickness



THROUGHBOLTS ZYP

ZINC AND YELLOW PLATED

- Concrete C20/25 To C50/60
- Non-Cracked Concrete
- Minimum 5µm

Part Number	Anchor Hole Size mm d_0	Anchor Length mm L	Thread Length mm L_{th}	Minimum Hole Depth mm h_1	Max Fixture Thickness mm t_{fix}	Quantity Per Box	Ship Wt.kg Per 100	Price £ Per 100
TB06045	6	45	18	35	5	100	1.26	11.58
TB06055	6	55	30	35	15	100	1.34	12.27
TB06085	6	85	60	35	45	100	2.12	14.04
TB08050	8	50	20	40	5	100	2.60	15.42
TB08065	8	65	30	40	20	100	3.14	17.19
TB08080	8	80	45	40	35	50	3.54	18.31
TB08100	8	100	60	40	55	50	4.08	20.95
TB08130	8	130	90	40	85	50	4.88	24.89
TB10065	10	65	30	50	8	50	4.80	25.37
TB10075	10	75	35	50	18	50	5.40	27.11
TB10090	10	90	55	50	33	50	6.32	29.29
TB10100	10	100	60	50	43	50	6.95	31.04
TB10120	10	120	80	50	63	20	8.20	37.92
TB10150	10	150	100	50	93	20	10.25	43.61
TB10175	10	175	100	50	118	20	12.30	51.64
TB12080	12	80	35	65	5	20	8.10	42.13
TB12100	12	100	55	65	25	20	9.60	47.07
TB12120	12	120	70	65	45	20	11.30	53.26
TB12140	12	140	90	65	65	20	13.00	58.45
TB12180	12	180	100	65	105	20	16.40	76.75
TB16105	16	105	55	85	10	20	19.85	84.36
TB16125	16	125	72	85	30	20	22.50	95.31
TB16150	16	150	90	85	55	20	26.18	108.17
TB16175	16	175	115	85	80	10	29.85	129.16
TB16220	16	220	125	85	125	10	35.00	165.62
TB20130	20	130	75	100	20	10	36.80	178.86
TB20160	20	160	100	100	50	10	45.20	197.88
TB20215	20	215	115	100	105	10	58.10	248.93
TB24180	24	180	105	120	45	10	69.00	361.42
TB24260	24	260	150	120	125	5	98.00	469.56



ETA OPTION 1 THROUGH BOLTS BZP

- Concrete C20/25 To C50/60
- Cracked Concrete
- Non-Cracked Concrete
- Fire Resistance Loading
- Minimum 5µm



BRIGHT ZINC PLATED

Part Number	Anchor Hole Size mm d_0	Anchor Length mm L	Thread Length mm L_{th}	Standard Embedment		Shallow Embedment		Quantity Per Box	Ship Wt.kg Per 100	Price £ Per 100
				Minimum Hole Depth mm h_1	Max Fixture Thickness mm t_{fx}	Minimum Hole Depth mm h_1	Max Fixture Thickness mm t_{fx}			
ETA08075	8	75	20	60	10	49	21	100	2.99	71.76
ETA08095	8	95	40	60	30	49	41	100	3.60	81.33
ETA08115	8	115	60	60	50	49	61	100	4.24	90.89
ETA10090	10	90	20	75	10	55	30	50	5.88	104.90
ETA10110	10	110	40	75	30	55	50	50	6.88	121.65
ETA10130	10	130	60	75	50	55	70	50	9.90	133.95
ETA12110	12	110	30	90	15	70	35	25	9.92	159.58
ETA12125	12	125	45	90	30	70	50	25	11.00	187.60
ETA12160	12	160	80	90	65	70	85	25	13.60	247.05
ETA12180	12	180	80	90	85	70	105	25	15.00	253.20
ETA16135	16	135	35	110	15	90	35	20	21.60	322.23
ETA16170	16	170	70	110	50	90	70	20	26.30	364.26
ETA16200	16	200	80	110	80	90	100	10	32.00	503.68
ETA20165	20	165	50	125	30	-	-	10	44.10	1,131.39
ETA20195	20	195	70	125	60	-	-	10	50.50	1,352.82



ETA OPTION 7 THROUGH BOLTS BZP

- Concrete C20/25 To C50/60
- Non-Cracked Concrete
- Minimum 5µm



BRIGHT ZINC PLATED

Part Number	Anchor Hole Size mm d_0	Anchor Length mm L	Thread Length mm L_{th}	Standard Embedment		Shallow Embedment		Quantity Per Box	Ship Wt.kg Per 100	Price £ Per 100
				Minimum Hole Depth mm h_1	Max Fixture Thickness mm t_{fx}	Minimum Hole Depth mm h_1	Max Fixture Thickness mm t_{fx}			
AWA06060	6	60	25	55	3	50*	8	100	1.36	12.88
AWA06080	6	80	45		23		28	100	2.10	14.74
AWA08050*	8	50	17	-	-	45*	3	100	2.60	16.19
AWA08065	8	65	22	-	-		8	100	3.14	18.04
AWA08075	8	75	32	65	3	50**	18	50	3.52	19.23
AWA08090	8	90	46		18		33	50	4.04	21.99
AWA08100	8	100	50		28		43	50	4.08	22.50
AWA08115	8	115	65		43		58	50	4.60	23.95
AWA08130	8	130	80		58		73	50	4.88	26.14
AWA10065*	10	65	22		-		-	55*	3	50
AWA10075	10	75	27	-	-	8	50		5.40	28.46
AWA10090	10	90	43	75	8	60	23	50	6.32	30.75
AWA10100	10	100	53		18		33	50	6.95	32.59
AWA10120	10	120	71		38		53	20	8.20	39.81
AWA10150	10	150	95		68		83	20	10.25	45.79
AWA12080*	12	80	32	-	-	60*	10	20	8.10	43.95
AWA12090	12	90	35	-	-		10	20	9.35	44.24
AWA12100	12	100	44	85	5	70	20	20	9.60	49.43
AWA12110	12	110	53		15		30	20	10.50	52.50
AWA12120	12	120	63		25		40	20	11.30	55.92
AWA12140	12	140	83		45		60	20	13.00	61.38
AWA12160	12	160	95		65		80	20	15.05	69.50
AWA12180	12	180	95		85		100	20	16.40	80.58
AWA12200	12	200	95	105	120	20	18.00	86.25		
AWA16105*	16	105	40	-	-	85*	6	20	19.85	88.58
AWA16125	16	125	60	-	-		11	20	22.50	100.07
AWA16145	16	145	80	115	16	100	31	20	25.80	113.57
AWA16170	16	170	105		41		56	10	29.10	135.62
AWA16220	16	220	115		91		106	10	35.00	173.90
AWA20130	20	130	60	-	-	110	5	10	36.80	187.81
AWA20170	20	170	100	20	45		10	46.65	207.78	
AWA20215	20	215	115	65	90		10	58.10	261.37	
AWA24180	24	180	100	155	5	125	33	10	69.00	379.49
AWA24260	24	260	150		85		113	5	98.00	493.04

* Not included in ETA

** Use restricted to the anchoring of structural components which are statically indeterminate.



THROUGHBOLTS HDG

**HOT DIPPED
GALVANISED**
 Concrete C20/25 To C50/60 Non-Cracked Concrete BS EN ISO1461:2009 Minimum 45µm

Part Number	Anchor Hole Size mm d_0	Anchor Length mm L	Thread Length mm L_{th}	Minimum Hole Depth mm h_1	Max Fixture Thickness mm t_{fx}	Quantity Per Box	Ship Wt.kg Per 100	Price £ Per 100
TG08050	8	50	15	45	5*	100	2.32	29.88
TG08075	8	75	40	65	10	100	3.44	35.74
TG08095	8	95	50	65	30	100	4.19	39.05
TG08120	8	120	85	65	55	100	5.09	44.84
TG10060	10	60	20	50	10*	50	4.62	51.50
TG10070	10	70	30	50	20*	50	5.21	54.84
TG10080	10	80	40	70	10	50	6.00	56.95
TG10100	10	100	55	70	30	50	6.94	65.62
TG10125	10	125	80	70	50	50	8.42	71.48
TG12085	12	85	40	70	10*	25	10.00	88.51
TG12100	12	100	55	90	5	25	10.20	94.33
TG12115	12	115	60	90	20	25	11.36	96.37
TG12145	12	145	95	90	50	25	13.92	115.15
TG12180	12	180	110	90	85	25	16.84	132.54
TG16110	16	110	50	85	15*	20	20.70	176.98
TG16125	16	130	65	110	10	20	22.50	191.10
TG16150	16	150	90	110	30	20	25.20	205.66
TG16200	16	200	115	110	80	20	30.03	260.03
TG20170	20	170	100	130	25	10	49.60	381.36
TG20220	20	220	125	130	75	10	65.00	493.16
TG20280	20	280	150	130	135	10	72.49	755.88

* Reduced loading due to shallow embedment



THROUGHBOLTS A2 STAINLESS STEEL

**A2-304
STAINLESS STEEL**
 Concrete C20/25 To C50/60 Non-Cracked Concrete Suitable For External Use

Part Number	Anchor Hole Size mm d_0	Anchor Length mm L	Thread Length mm L_{th}	Minimum Hole Depth mm h_1	Max Fixture Thickness mm t_{fx}	Quantity Per Box	Ship Wt.Kg Per 100	Price £ Per 100
TSSA206045	6	40	20	35	5	100	1.15	50.83
TSSA206065	6	65	30	35	25	100	1.38	59.07
TSSA208050	8	50	18	40	5	100	2.32	77.59
TSSA208075	8	75	41	40	30	50	3.44	94.12
TSSA208095	8	95	60	40	50	50	4.19	105.88
TSSA208120	8	120	64	40	75	50	5.09	136.94
TSSA210060	10	60	20	50	3	50	4.62	125.56
TSSA210080	10	80	40	50	23	50	6.00	150.79
TSSA210100	10	100	59	50	43	50	6.94	169.31
TSSA210125	10	125	85	50	68	20	8.42	190.88
TSSA210150	10	150	78	50	93	20	10.25	462.36
TSSA210175	10	175	88	50	118	20	11.40	618.61
TSSA212085	12	85	40	65	10	20	10.00	202.31
TSSA212100	12	100	60	65	25	20	10.20	236.25
TSSA212115	12	115	59	65	40	20	11.36	271.76
TSSA212145	12	145	80	65	70	20	13.92	298.75
TSSA212200	12	200	85	65	125	20	16.84	611.39
TSSA216110	16	110	50	85	15	20	16.80	544.03
TSSA216125	16	125	65	85	30	20	18.00	591.94
TSSA216150	16	150	90	85	55	20	25.20	675.74
TSSA216175	16	175	83	85	80	10	30.50	886.85
TSSA220170	20	170	83	100	60	10	49.60	1,322.96
TSSA220220	20	220	115	100	110	10	65.00	1,773.43



ETA OPTION 1 THROUGH BOLTS A4 STAINLESS STEEL



- Concrete C20/25 To C50/60
- Cracked Concrete
- Non-Cracked Concrete
- Fire Resistance Loading
- Suitable For External Use And Marine Environments

**A4-316
STAINLESS STEEL**

Part Number	Anchor Hole Size mm d_0	Anchor Length mm L	Thread Length mm L_{th}	Standard Embedment		Shallow Embedment		Quantity Per Box	Ship Wt.Kg Per 100	Price £ Per 100
				Minimum Hole Depth mm h_1	Max Fixture Thickness mm t_{fix}	Minimum Hole Depth mm h_1	Max Fixture Thickness mm t_{fix}			
ETA08065SS*	8	65	22	-	-	50	11	100	2.69	264.17
ETA08080SS	8	80	37	60	15	50	26	100	3.14	284.67
ETA08095SS	8	95	52	60	30	50	41	100	3.60	347.75
ETA80115SS	8	115	72	60	50	50	61	100	4.24	388.36
ETA10080SS*	10	80	32	-	-	55	20	50	5.38	374.96
ETA10100SS	10	100	52	75	20	55	40	50	6.36	420.69
ETA10130SS	10	130	82	75	50	55	70	50	7.90	628.08
ETA10180SS	10	180	132	75	100	55	120	50	10.32	1021.18
ETA12095SS*	12	95	36	-	-	70	20	25	9.12	561.45
ETA12110SS	12	110	51	90	15	70	35	25	10.20	636.76
ETA12125SS	12	125	66	90	30	70	50	25	11.36	689.20
ETA12160SS	12	160	101	90	65	70	85	25	13.92	932.86
ETA12200SS	12	200	135	90	105	70	125	25	16.84	1,156.42
ETA16115SS*	16	115	36	-	-	90	15	20	18.80	1,279.04
ETA16135SS	16	135	56	110	15	90	35	20	21.60	1,460.40
ETA16170SS	16	170	91	110	50	90	70	20	26.80	1,906.33
ETA16220SS	16	220	80	110	100	-	-	10	35.90	2,593.16
ETA20165SS	20	165	50	125	30	-	-	10	45.10	3,883.63
ETA20195SS	20	195	70	125	60	-	-	10	51.40	4,296.04
ETA20235SS	20	235	80	125	100	-	-	5	61.80	5,002.59

* Reduced loading due to shallow embedment



ETA OPTION 7 THROUGH BOLTS A4 STAINLESS STEEL



- Concrete C20/25 To C50/60
- Non-Cracked Concrete
- Fire Resistance Loading
- Suitable For External Use And Marine Environments

**A4-316
STAINLESS STEEL**

Part Number	Anchor Hole Size mm d_0	Anchor Length mm L	Thread Length mm L_{th}	Minimum Hole Depth mm h_1	Max Fixture Thickness mm t_{fix}	Quantity Per Box	Ship Wt.Kg Per 100	Price £ Per 100
TSS06040	6	40	16	35	5*	100	1.12	105.07
TSS06065	6	67	30	55	10	100	1.38	130.38
TSS08050	8	50	22	45	5*	100	2.32	123.66
TSS08075	8	75	40	65	10	100	3.44	139.99
TSS08095	8	95	60	65	30	100	4.19	165.30
TSS08120	8	120	85	65	55	100	5.09	197.98
TSS10060	10	60	25	50	10*	50	4.62	187.73
TSS10080	10	85	40	70	10	50	6.00	216.88
TSS10100	10	105	60	70	30	50	6.94	250.83
TSS10125	10	125	80	70	50	50	8.42	284.79
TSS10175	10	175	80	70	100	50	11.40	418.06
TSS10215	10	215	80	70	140	25	12.40	597.13
TSS12085	12	95	50	80	14*	25	10.00	334.77
TSS12100	12	105	60	90	10	25	10.20	350.14
TSS12115	12	115	70	90	20	25	11.36	398.20
TSS12145	12	145	100	90	50	25	13.92	475.40
TSS12200	12	200	100	90	105	25	16.84	719.83
TSS16110	16	115	60	90	13*	20	16.80	822.66
TSS16125	16	130	70	110	10	20	18.00	914.60
TSS16150	16	150	90	110	30	20	25.20	955.28
TSS16175	16	180	110	110	60	20	30.05	1,151.34
TSS20170	20	180	70	130	35	10	49.60	1,838.81
TSS20220	20	240	70	130	95	10	65.00	2,802.10

* Reduced loading due to shallow embedment



WIREHANGERS

ZINC AND YELLOW PLATED

The wirehanger is an expansion anchor for securing suspension wires.

- ✔ Non-Cracked Concrete
- ✔ Fast And Secure Installation
- ✔ Pull Down Expansion
- ✔ Hammer In Fixing
- ✔ Minimum 5µm

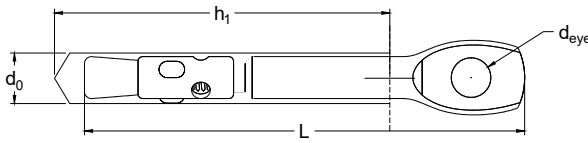

d_0 =Anchor Hole Size L=Anchor Length d_{eye} =Eye Diameter h_1 =Minimum Hole Depth

Part Number	Anchor Hole Size mm d_0	Anchor Length mm L	Eye Diameter mm d_{eye}	Minimum Hole Depth mm h_1	Rec Tensile Load kN	Quantity Per Box	Ship Wt.kg Per 100	Price £ Per 100
TW06055	6	55	6	40	1.5	100	1.15	14.74



NAIL IN SOCKETS



A dual-thread socket for multiple use in non-structural concrete applications. Simply hammer into the base material.

- ✔ Concrete C12/15
- ✔ Concrete C20/25 To C50/60
- ✔ Cracked Concrete
- ✔ Non-Cracked Concrete
- ✔ Fast And Secure Installation
- ✔ Auto Expanding Action
- ✔ No Torque Wrench Required
- ✔ Fire Resistance Classification R120

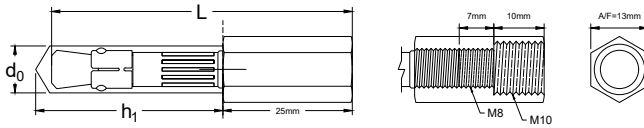

d_0 =Anchor Hole Size L=Anchor Length h_1 =Minimum Hole Depth

Part Number	Anchor Hole Size mm d_0	Anchor Length mm L	Internal Thread Diameter M	Minimum Hole Depth mm h_1	Rec Tensile Load kN	Quantity Per Box	Ship Wt.kg Per 100	Price £ Per 100
NAS0625	6	25	8 & 10	30	2.14	100	2.75	116.24
NAS0630	6	30	8 & 10	35	2.81	100	2.85	123.86

JCP IS A MEMBER OF THE EUROPEAN CONSORTIUM OF ANCHOR PRODUCERS

A small group of small and medium-sized European producers, the members join forces in a 100% self-financed consortium to influence the standardisation of their products. The products include mechanical, chemical and plastic anchors, powder actuated tools and their components, concrete and wood screws and 3-D nailing plates.





ANKERBOLTS AND ACCESSORIES

The ankerbolt is a self-tapping anchor for use in a variety of base materials, with the self-tapping action providing a positive anchorage in cracked and non-cracked concrete, brick, stone, and blocks.

- ✔ Fast and Secure Installation
- ✔ Expansion Free
- ✔ Undercutting Action
- ✔ Through Fixing
- ✔ High-Performance

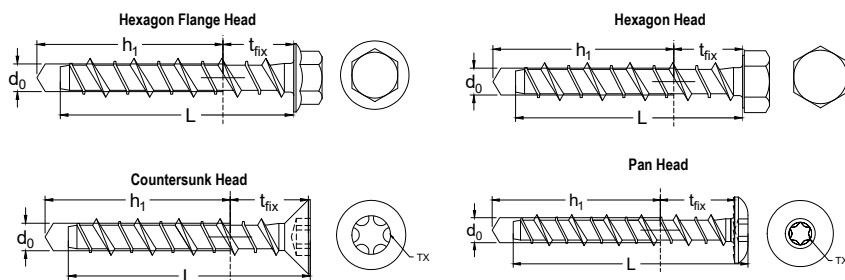

d_0 = Anchor Hole Size L = Anchor Length t_{fix} = Max Fixture Thickness h_1 = Minimum Hole Depth



HEXAGON FLANGE HEAD ANKERBOLTS BZP

BRIGHT ZINC PLATED

- ✔ Concrete C20/25 To C50/60
- ✔ Non-Cracked Concrete
- ✔ Minimum 5µm

Part Number	Anchor Hole Size mm d_0	Anchor Length mm L	Max Fixture Thickness mm t_{fix}	Minimum Hole Depth mm h_1	Across Flats mm A/F	Quantity Per Box	Ship Wt.kg Per 100	Price £ Per 100
JAB05/06050	5	50	25	35	8	100	0.98	13.18
JAB05/06075	5	75	50	35	8	100	1.35	17.09
JAB05/06100	5	100	75	35	8	100	1.60	23.69
JAB06/08030	6	30	5	35	10	100	1.00	14.83
JAB06/08050	6	50	20	40	10	100	1.49	19.69
JAB06/08075	6	75	45	40	10	100	2.02	25.20
JAB06/08100	6	100	70	40	10	100	2.57	32.14
JAB06/08130	6	130	100	40	10	100	3.23	44.44
JAB06/08150	6	150	120	40	10	100	3.66	48.91



HEXAGON HEAD ANKERBOLTS BZP

**BRIGHT ZINC
PLATED**

- Concrete C20/25 To C50/60 Non-Cracked Concrete Minimum 5µm

Part Number	Anchor Hole Size mm d_0	Anchor Length mm L	Max Fixture Thickness mm t_{fx}	Minimum Hole Depth mm h_1	Across Flats mm A/F	Quantity Per Box	Ship Wt.kg Per 100	Price £ Per 100
JAB08/10060	8	60	20	55	15	100	2.99	37.66
JAB08/10075	8	75	35	55	15	100	3.58	44.90
JAB08/10100	8	100	60	55	15	100	4.53	56.29
JAB08/10130	8	130	90	55	15	50	5.20	75.72
JAB08/10150	8	150	110	55	15	50	5.48	87.94
JAB10/12060	10	60	10	70	17	50	4.68	59.36
JAB10/12075	10	75	25	70	17	50	5.50	69.09
JAB10/12100	10	100	50	70	17	50	7.06	87.84
JAB10/12130	10	130	80	70	17	25	9.50	115.89
JAB10/12150	10	150	100	70	17	25	10.15	131.05
JAB12/14075	12	75	15	85	19	50	8.00	116.46
JAB12/14100	12	100	40	85	19	50	10.18	139.98
JAB12/14130	12	130	70	85	19	25	12.75	184.94
JAB12/14150	12	150	90	85	19	20	14.17	214.68
JAB12/14200	12	200	140	85	19	20	18.90	271.56
JAB14/16075	14	75	5	100	24	25	12.62	207.54
JAB14/16100	14	100	30	100	24	25	15.51	235.22
JAB14/16130	14	130	60	100	24	20	19.00	276.66
JAB14/16150	14	150	80	100	24	10	21.30	312.59
JAB14/16200	14	200	130	100	24	10	27.19	395.35
JAB16/18100*	16	100	20	110	27	10	22.00	306.47
JAB16/18150*	16	150	70	110	27	10	29.70	389.12
JAB16/18200*	16	200	120	110	27	10	37.60	497.25

* Mechanical Galvanised • Min 40µm



ETA OPTION 1 HEXAGON HEAD ANKERBOLTS BZP



- Concrete C20/25 To C50/60 Cracked Concrete Non-Cracked Concrete
 Fire Resistance Loading Minimum 5µm

**BRIGHT ZINC
PLATED**

Part Number	Anchor Hole Size mm d_0	Anchor Length mm L	Max Fixture Thickness mm t_{fx}	Minimum Hole Depth mm h_1	Across Flats mm A/F	Quantity Per Box	Ship Wt.kg Per 100	Price £ Per 100
JAB08/10075ETA	8	80	5	90	15	100	3.58	57.40
JAB08/10100ETA	8	100	25	90	15	100	4.53	66.40
JAB08/10130ETA	8	130	55	90	15	50	5.20	71.70
JAB08/10150ETA	8	150	75	90	15	50	5.48	82.18
JAB10/12100ETA	10	100	15	100	17	50	7.06	103.23
JAB10/12130ETA	10	130	45	100	17	25	9.50	136.80
JAB10/12150ETA	10	150	65	100	17	25	10.15	154.95
JAB12/14100ETA	12	100	5	110	19	50	10.18	167.46
JAB12/14130ETA	12	130	35	110	19	25	12.75	220.87
JAB12/14150ETA	12	150	55	110	19	20	14.17	247.89
JAB12/14200ETA	12	200	105	110	19	20	18.90	252.80
JAB14/16130ETA	14	130	20	130	24	20	19.00	299.36
JAB14/16150ETA	14	150	50	130	24	10	21.30	336.19
JAB14/16200ETA	14	200	90	130	24	10	27.19	412.13
JAB16/18150ETA	16	150	30	145	27	10	29.70	426.42
JAB16/18200ETA	16	200	80	145	27	10	37.60	552.23



COUNTERSUNK HEAD ANKERBOLTS BZP

**BRIGHT ZINC
PLATED**
 Concrete C20/25 To C50/60 Non-Cracked Concrete Minimum 5µm

Part Number	Anchor Hole Size mm d_0	Anchor Length mm L	Max Fixture Thickness mm t_{fx}	Minimum Hole Depth mm h_1	Head Diameter mm	Driver Type TX	Quantity Per Box	Ship Wt.kg Per 100	Price £ Per 100
JAB05/06030CS	5	30	5	35	9.5	T25	100	0.83	8.75
JAB05/06050CS	5	50	20	40	9.5	T25	100	0.97	11.53
JAB05/06075CS	5	75	45	40	9.5	T25	100	1.32	15.83
JAB05/06100CS	5	100	70	40	9.5	T25	100	1.65	22.26
JAB06/08030CS	6	30	5	35	12.5	T30	100	0.85	11.97
JAB06/08050CS	6	50	20	40	12.5	T30	100	1.19	16.09
JAB06/08075CS	6	75	45	40	12.5	T30	100	1.73	21.72
JAB06/08100CS	6	100	70	40	12.5	T30	100	2.58	30.96
JAB06/08130CS	6	130	100	40	12.5	T30	100	2.94	39.74
JAB06/08150CS	6	150	120	40	12.5	T30	100	3.32	46.87
JAB08/10060CS	8	60	20	55	17.5	T45	100	2.89	37.40
JAB08/10075CS	8	75	35	55	17.5	T45	100	3.48	45.58
JAB08/10100CS	8	100	60	55	17.5	T45	100	4.43	59.40
JAB10/12060CS	10	60	10	70	21	T50	50	4.58	61.01
JAB10/12075CS	10	75	25	70	21	T50	50	5.40	74.47
JAB10/12100CS	10	100	50	70	21	T50	50	6.96	96.88



PAN HEAD ANKERBOLTS BZP

**BRIGHT ZINC
PLATED**
 Concrete C20/25 To C50/60 Non-Cracked Concrete Minimum 5µm

Part Number	Anchor Hole Size mm d_0	Anchor Length mm L	Max Fixture Thickness mm t_{fx}	Minimum Hole Depth mm h_1	Head Diameter mm	Driver Type TX	Quantity Per Box	Ship Wt.kg Per 100	Price £ Per 100
JAB05/06050PH	5	50	25	35	16	T25	100	1.08	17.82
JAB05/06075PH	5	75	50	35	16	T25	100	1.45	22.47
JAB05/06100PH	5	100	75	35	16	T25	100	1.81	26.24
JAB06/08030PH	6	30	5	35	16	T30	100	1.25	19.82
JAB06/08050PH	6	50	20	40	16	T30	100	1.70	25.20
JAB06/08075PH	6	75	45	40	16	T30	100	2.26	32.33
JAB06/08100PH	6	100	70	40	16	T30	100	2.82	41.15



HEXAGON FLANGE HEAD ANKERBOLTS GALV

**MECHANICAL
GALVANISED**
 Concrete C20/25 To C50/60 Non-Cracked Concrete Minimum 40µm

Part Number	Anchor Hole Size mm d_0	Anchor Length mm L	Max Fixture Thickness mm t_{fx}	Minimum Hole Depth mm h_1	Across Flats mm A/F	Quantity Per Box	Ship Wt.kg Per 100	Price £ Per 100
JAB06/08050G	6	50	20	40	10	100	1.49	20.60
JAB06/08075G	6	75	45	40	10	100	2.02	26.80
JAB06/08100G	6	100	70	40	10	100	2.57	33.62



HEXAGON HEAD ANKERBOLTS GALV

**MECHANICAL
GALVANISED**
 Concrete C20/25 To C50/60 Non-Cracked Concrete Minimum 40µm

Part Number	Anchor Hole Size mm d_0	Anchor Length mm L	Max Fixture Thickness mm t_{fx}	Minimum Hole Depth mm h_1	Across Flats mm A/F	Quantity Per Box	Ship Wt.kg Per 100	Price £ Per 100
JAB08/10060G	8	60	20	55	15	100	2.99	39.69
JAB08/10100G	8	100	60	55	15	100	4.53	58.13
JAB08/10150G	8	150	110	55	15	50	5.48	90.34
JAB10/12060G	10	60	10	70	17	50	4.68	63.09
JAB10/12100G	10	100	50	70	17	50	7.06	91.79
JAB10/12150G	10	150	100	70	17	25	10.15	134.79
JAB12/14100G	12	100	40	85	19	50	10.18	144.22
JAB12/14150G	12	150	90	85	19	20	14.17	217.37
JAB12/14200G	12	200	140	85	19	20	18.90	280.34



ETA HEXAGON FLANGE HEAD ANKERBOLTS A4 STAINLESS STEEL

NEW LINE ADDED

 Concrete C20/25 To C50/60 Cracked Concrete Non-Cracked Concrete
 Bi-Metallic Carbon Steel Tip With Leading Threads To Cut Into Concrete
 ETAG 001-6 Fire Resistance Loading Suitable For External Use And Marine Environments

**A4-316
STAINLESS STEEL**

Part Number	Anchor Hole Size mm d_0	Anchor Length mm L	Max Fixture Thickness mm t_{fx}	Minimum Hole Depth mm h_1	Across Flats mm A/F	Quantity Per Box	Ship Wt.kg Per 100	Price £ Per 100
JAB06/08050SS*	6	50	20	40	10	100	1.54	165.80
JAB06/08075SS	6	75	45	40	10	100	2.08	221.20
JAB06/08100SS	6	100	70	40	10	100	2.63	265.43
JAB08/10060SS*	8	60	20	55	13	100	3.27	288.15
JAB08/10075SS	8	75	35	55	13	100	3.87	356.30
JAB08/10100SS	8	100	60	55	13	100	4.88	448.37
JAB10/12075SS*	10	75	25	70	17	50	6.44	507.75
JAB10/12100SS*	10	100	50	70	17	50	7.96	634.89
JAB10/12135SS	10	135	85	70	17	25	9.80	696.36
JAB10/12150SS*	10	150	100	70	17	25	11.04	958.91
JAB12/14100SS*	12	100	40	85	19	50	11.53	856.09

* Not included in ETA



ETA COUNTERSUNK ANKERBOLTS A4 STAINLESS STEEL

NEW LINES ADDED

 Concrete C20/25 To C50/60 Cracked Concrete Non-Cracked Concrete
 Bi-Metallic Carbon Steel Tip With Leading Threads To Cut Into Concrete
 ETAG 001-6 Fire Resistance Loading Suitable For External Use And Marine Environments

**A4-316
STAINLESS STEEL**

Part Number	Anchor Hole Size mm d_0	Anchor Length mm L	Max Fixture Thickness mm t_{fx}	Minimum Hole Depth mm h_1	Head Diameter mm	Driver Type TX	Quantity Per Box	Ship Wt.kg Per 100	Price £ Per 100
JAB06/08050CSSS*	6	50	5	55	15	T40	100	1.49	177.36
JAB06/08075CSSS	6	75	20	65	15	T40	100	2.04	231.16
JAB06/08100CSSS	6	100	45	65	15	T40	100	2.60	288.15
JAB08/10050CSSS	8	50	10	55	18	T45	100	2.60	242.72
JAB08/10060CSSS	8	60	20	55	18	T45	100	2.90	255.35
JAB08/10075CSSS	8	75	35	55	18	T45	100	3.50	279.90
JAB08/10100CSSS	8	100	60	55	18	T45	100	4.46	354.11

* Not included in ETA



ETA PAN HEAD ANKERBOLTS A4 STAINLESS STEEL AND ALLOY STEEL **NEW**



- Concrete C20/25 To C50/60
- Cracked Concrete
- Non-Cracked Concrete
- Bi-Metallic
- Carbon Steel Tip With Leading Threads To Cut Into Concrete
- ETAG 001-6
- Fire Resistance Loading
- Suitable For External Use And Marine Environments

**A4-316
STAINLESS STEEL**

Part Number	Anchor Hole Size mm d_0	Anchor Length mm L	Max Fixture Thickness mm t_{fix}	Minimum Hole Depth mm h_1	Head Diameter mm	Driver Type TX	Quantity Per Box	Ship Wt.kg Per 100	Price £ Per 100
JAB06/08050PHSS	6	50	20	40	16.5	T40	100	1.60	149.70
JAB06/08075PHSS	6	75	45	40	16.5	T40	100	2.20	205.80
JAB06/08100PHSS	6	100	70	40	16.5	T40	100	2.74	250.10



BI-METAL MASONRY SCREWS A4 STAINLESS STEEL **NEW**

**A4-316
STAINLESS STEEL**

A high-quality, self-tapping screw which speeds up installation time, enables thread cutting, and avoids corrosion.

- Super Fast
- Efficient Thread Cutting
- Excellent Corrosion Resistance
- Bi-Metallic

Part Number	Anchor Hole Size mm d_0	Anchor Length mm L	Max Fixture Thickness mm t_{fix}	Minimum Hole Depth mm h_1	Across Flats mm A/F	Quantity Per Box	Ship Wt.kg Per 100	Price £ Per 100
MS63045SS	5	45	20	40	8	100	0.75	68.53
MS63057SS	5	57	32	40	8	100	0.90	85.02
MS63070SS	5	70	70	40	8	100	1.12	92.92



ANKERBOLT DROP-IN

**BRIGHT ZINC
PLATED**

A self-tapping anchor providing a flush internal thread. Ideal for threaded rods or bolts.

- Undercutting Action
- Provides A Flush Fixing
- Minimum 5µm

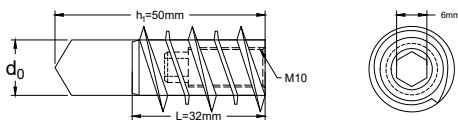

d_0 =Anchor Hole Size L =Anchor Length h_1 =Minimum Hole Depth

Part Number	Anchor Hole Size mm d_0	Anchor Length mm L	Minimum Hole Depth mm h_1	Internal Thread Diameter M	Head Diameter mm	Driver Type	Quantity Per Box	Ship Wt.kg Per 100	Price £ Per 100
JABDBM10	13	32	50	10	N/A	6mm Hex	100	2.20	78.08



ANKERBOLT DROP-IN SETTING TOOL

The ankerbolt drop in setting tool is designed to assist in rapid and repetitive application of drop-in anchors.

- Used With An Impact Driver

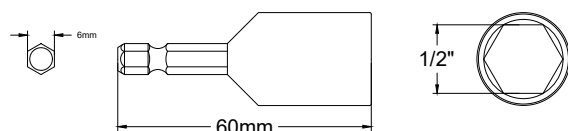

Part Number	Drive Size	Quantity Per Box	Ship Wt.kg Per 100	Price £ Per Each
JABDBM10ST	1/2	1	6.50	7.11



JAB06/08SOCKET



JAB06/08SOCM08
JAB06/08SOCM10

SOCKET BOLTS

- Concrete C20/25 To C50/60
- Fire Resistance Classification R120



BRIGHT ZINC PLATED

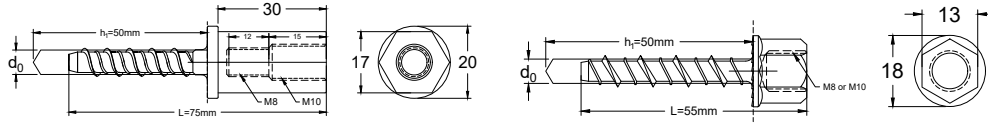

d_0 = Anchor Hole Size L = Anchor Length h_1 = Minimum Hole Depth

Part Number	Anchor Hole Size mm d_0	Anchor Length mm L	Minimum Hole Depth mm h_1	Internal Thread Diameter M	Across Flats mm A/F	Quantity Per Box	Ship Wt.kg Per 100	Price £ Per 100
JAB06/08SOCKET	6	75	50	8 & 10	17	50	6.42	122.26
JAB06/08SOCM08	6	55	50	8	13	100	2.20	46.82
JAB06/08SOCM10	6	55	50	10	13	100	2.00	47.50

ETA DUAL THREADED SOCKET BOLTS

- Concrete C20/25 To C50/60
- Cracked Concrete
- Non-Cracked Concrete
- ETAG 001-6
- Fire Resistance Classification R120
- Minimum 5 μ m



BRIGHT ZINC PLATED

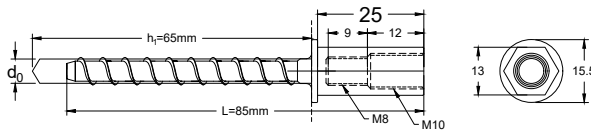

d_0 = Anchor Hole Size L = Anchor Length h_1 = Minimum Hole Depth

Part Number	Anchor Hole Size mm d_0	Anchor Length mm L	Minimum Hole Depth mm h_1	Internal Thread Diameter M	Across Flats mm A/F	Quantity Per Box	Ship Wt.kg Per 100	Price £ Per 100
JAB06/08SOCETA	6	85	65	8 & 10	13	100	3.07	127.96

HOOK BOLTS AND EYE BOLTS

- Fast And Secure Installation
- Expansion Free
- Minimum 5 μ m

BRIGHT ZINC PLATED



Hook Bolt

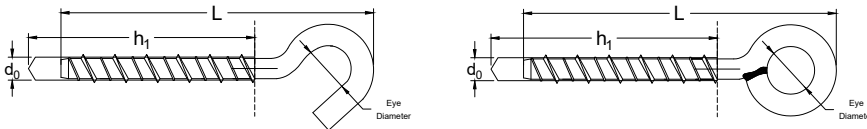

d_0 = Anchor Hole Size L = Anchor Length h_1 = Minimum Hole Depth



Eye Bolt

Part Number	Anchor Hole Size mm d_0	Thread Length mm	Anchor Length mm L	Minimum Hole Depth mm h_1	Eye Diameter mm	Quantity Per Box	Ship Wt.kg Per 100	Price £ Per 100
JAB06/08050HOOK	6	50	90	65	13	50	2.56	74.78
JAB08/10055HOOK	8	55	100	70	14	50	4.96	104.15
JAB06/08050EYE	6	50	90	65	13	50	2.80	86.75
JAB08/10055EYE	8	55	100	70	14	50	5.50	135.04



INTERNAL THREADED ANCHORS

A deformation-controlled internally threaded socket anchor suitable for multiple use. The anchor can be accurately set independent of the hole depth, preventing the anchor from being inserted too far. The internal thread is suitable for bolts or threaded studs.

- ✔ Fast And Secure Installation
- ✔ Deformation-Controlled Expansion
- ✔ Reaction To Fire Class A1
- ✔ Permanent Socket Allows For Removal And Replacement Of The Fixture

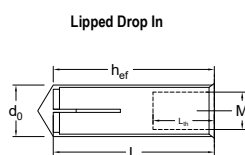
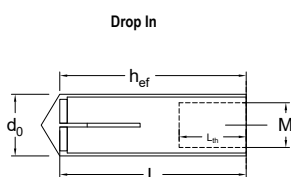

M=Internal Thread Diameter d_0 =Anchor Hole Size L=Anchor Length h_1 =Minimum Hole Depth L_{th} =Internal Thread Length



DROP IN ANCHORS ZYP

ZINC AND YELLOW PLATED

- ✔ Concrete C20/25 To C50/60
- ✔ Non-Cracked Concrete
- ✔ Minimum 5µm

Part Number	Internal Thread Diameter M	Anchor Hole Size mm d_0	Thread Length mm L	Minimum Hole Depth mm h_1	Internal Thread Length mm L_{th}	Quantity Per Box	Ship Wt.kg Per 100	Price £ Per 100
DBM06	6	8	25	25	10	100	0.84	4.92
DBM08	8	10	30	30	14	100	1.58	7.95
DBM10	10	12	40	40	15	50	2.40	15.01
DBM12	12	15	50	50	20	50	5.92	34.65
DBM16	16	20	65	65	22	25	11.20	65.49
DBM20	20	25	80	80	30	25	19.00	169.34



ETA DROP IN ANCHORS BZP



- ✔ Solid Cracked Concrete C20/25 To C50/60
- ✔ Solid Non-Cracked Concrete C20/25 To C50/60
- ✔ ETAG 001-6
- ✔ Fire Resistance Loading
- ✔ Minimum 5µm
- ✔ Manufactured In Europe

BRIGHT ZINC PLATED

Part Number	Internal Thread Diameter M	Anchor Hole Size mm d_0	Anchor Length mm L	Minimum Hole Depth mm h_1	Internal Thread Length mm L_{th}	Quantity Per Box	Ship Wt.kg Per 100	Price £ Per 100
ADBM08	8	10	30	30	13	100	1.17	27.05
ADBM10	10	12	40	40	15	50	2.14	44.77
ADBM12	12	15	50	50	18	50	4.36	70.21
ADBM16	16	20	65	65	23	25	10.20	145.57



ETA DROP IN ANCHORS BZP **NEW**



- Solid Cracked Concrete C20/25 To C50/60
- Solid Non-Cracked Concrete C20/25 To C50/60
- ETAG 001-6
- Fire Resistance Loading
- Minimum 5µm
- Cost-Effective Solution

**BRIGHT ZINC
PLATED**

Part Number	Internal Thread Diameter M	Anchor Hole Size mm d_0	Thread Length mm L	Minimum Hole Depth mm h_1	Internal Thread Length mm L_{th}	Quantity Per Box	Ship Wt.kg Per 100	Price £ Per 100
DBM0830	8	10	30	30	14	100	1.10	13.50
DBM1040	10	12	40	40	15	50	2.10	20.77
DBM1250	12	15	50	50	20	50	5.00	42.25



ETA DROP IN ANCHORS A4 STAINLESS STEEL



- Solid Cracked Concrete C20/25 To C50/60
- Solid Non-Cracked Concrete C20/25 To C50/60
- ETAG 001-6
- Fire Resistance Loading
- Suitable For External Use And Marine Environments
- Manufactured In Europe

**A4-316
STAINLESS STEEL**

Part Number	Internal Thread Diameter M	Anchor Hole Size mm d_0	Anchor Length mm L	Minimum Hole Depth mm h_1	Internal Thread Length mm L_{th}	Quantity Per Box	Ship Wt.kg Per 100	Price £ Per 100
DSSM06	6	8	30	30	11	100	0.82	118.96
DSSM08	8	10	30	30	13	100	1.60	147.34
DSSM10	10	12	40	40	15	50	2.38	259.66
DSSM12	12	15	50	50	19	50	5.96	484.30
DSSM16	16	20	65	65	25	25	11.80	923.01



LIPPED DROP IN ANCHORS ZYP

**ZINC AND
YELLOW PLATED**

- Concrete C20/25 To C50/60
- Non-Cracked Concrete
- Minimum 5µm

Part Number	Internal Thread Diameter M	Anchor Hole Size mm d_0	Anchor Length mm L	Minimum Hole Depth mm h_1	Internal Thread Length mm L_{th}	Quantity Per Box	Ship Wt.kg Per 100	Price £ Per 100
DBM06SH	6	8	25	25	10	100	0.84	9.03
DBM08SH	8	10	30	30	14	100	1.58	13.95
DBM10SH	10	12	30	30	15	50	2.00	19.25
DBM10SHL	10	12	40	40	15	50	2.40	23.15
DBM12SH	12	15	50	50	20	50	5.92	46.90
DBM16SH	16	20	65	65	22	25	11.20	62.98



ETA LIPPED DROP IN ANCHORS BZP



- Concrete C20/25 To C50/60
- Cracked Concrete
- Non-Cracked Concrete
- Solid Concrete C12/15 To C50/60
- ETAG 001-6
- Fire Resistance Loading
- Minimum 5µm
- Manufactured In Europe

**BRIGHT ZINC
PLATED**

Part Number	Internal Thread Diameter M	Anchor Hole Size mm d_0	Anchor Length mm L	Minimum Hole Depth mm h_1	Internal Thread Length mm L_{th}	Quantity Per Box	Ship Wt.kg Per 100	Price £ Per 100
ADBM0825SH	8	10	25	25	12	100	1.05	24.06
ADBM0830SH	8	10	30	35	13	100	1.15	24.35
ADBM1025SH	10	12	25	25	12	50	1.60	29.86
ADBM1030SH	10	12	30	30	13	50	1.78	32.50
ADBM1040SH	10	12	40	40	15	50	2.20	40.29
ADBM1225SH	12	15	25	25	12	50	2.30	52.17
ADBM1250SH	12	15	50	50	18	50	4.30	63.19



ETA LIPPED DROP IN ANCHORS BZP NEW



- Concrete C20/25 To C50/60
- Cracked Concrete
- Non-Cracked Concrete
- Solid Concrete C12/15 To C50/60
- ETAG 001-6
- Fire Resistance Loading
- Minimum 5µm
- Cost-Effective Solution

**BRIGHT ZINC
PLATED**

Part Number	Internal Thread Diameter M	Anchor Hole Size mm d_0	Thread Length mm L	Minimum Hole Depth mm h_1	Internal Thread Length mm L_{th}	Quantity Per Box	Ship Wt.kg Per 100	Price £ Per 100
DBM0830SH	8	10	30	30	13	100	1.12	15.34
DBM1030SH	10	12	30	30	15	50	1.75	21.17
DBM1040SH	10	12	40	40	15	50	2.15	25.46
DBM1250SH	12	15	50	50	20	50	5.20	51.59



ETA LIPPED DROP IN ANCHORS A4 STAINLESS STEEL



- Concrete C20/25 To C50/60
- Cracked Concrete
- Non-Cracked Concrete
- Solid Concrete C12/15 To C50/60
- ETAG 001-6
- Fire Resistance Loading
- Suitable For External Use And Marine Environments
- Manufactured In Europe

**A4-316
STAINLESS STEEL**

Part Number	Internal Thread Diameter M	Anchor Hole Size mm d_0	Anchor Length mm L	Minimum Hole Depth mm h_1	Internal Thread Length mm L_{th}	Quantity Per Box	Ship Wt.kg Per 100	Price £ Per 100
ADSSM08SH	8	10	30	30	13	100	1.15	170.26
ADSSM10SH	10	12	40	40	15	50	2.20	299.57
ADSSM12SH	12	15	50	50	18	50	4.30	559.27



ETA DROP IN ANCHOR SETTING PUNCHES

The setting tool is designed to assist in rapid and repetitive application of drop in anchors into the substrate.

- Safely Install ETA Approved Drop In Anchors Used With A Hammer

Part Number	Drop In Anchor	Quantity Per Box	Ship Wt.kg Per Each	Price £ Per Each
ESM0825	ADB0825SH	1	0.45	17.00
ESM0830	ADB0830SH and ADSSM08SH	1	0.45	17.00
ESM1025	ADB1025SH	1	0.45	17.60
ESM1030	ADB1030SH	1	0.45	17.60
ESM1040	ADB1040SH and ADSSM10SH	1	0.45	17.60
ESM1225	ADB1225SH	1	0.45	30.00
ESM1250	ADB1250SH and ADSSM12SH	1	0.45	30.00



DROP IN ANCHOR SETTING PUNCHES

- Safely Install Drop In Anchors Used With A Hammer

Part Number	Quantity Per Box	Ship Wt.kg Per Each	Price £ Per Each
DZSP06	1	0.10	2.35
DZSP08	1	0.15	3.30
DZSP10	1	0.16	4.70
DZSP12	1	0.22	5.00
DZSP16*	1	0.41	5.50
DZSP20*	1	0.55	6.00

With Hand Guard

*Without hand guard



Without Hand Guard

STOP DRILL BITS

For drilling the correct hole depth for 25mm and 30mm drop in anchors, reducing the risk of hitting rebar.

- Collar To Ensure Correct Depth



Part Number	Diameter mm	Working Length mm	Overall Length mm	Quantity Per Box	Ship Wt.kg Per Each	Price £ Per Each
SD10025	10	25	110	1	0.71	2.96
SD10030	10	30	110	1	0.73	2.96
SD12025	12	25	110	1	0.80	3.25
SD12030	12	30	110	1	0.85	3.25



HOOK AND EYE BOLTS

Hook and eye bolts can be used with a variety of internal threaded fixings for static loads. Scaffold ring bolts, retaining eyes and eye plugs are used as part of scaffold restraint system.



FORGED HOOK BOLTS

- ✓ Forging Process Helps Prevent Hook Opening Out When Load Is Applied
- ✓ Minimum 5µm

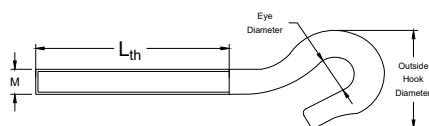

M=Thread Diameter L_{th} =Thread Length

**BRIGHT ZINC
PLATED**

Part Number	Thread Diameter M	Thread Length mm L_{th}	Hook Diameter mm	Outside Hook Diameter mm	Quantity Per Box	Ship Wt.kg Per 100	Price £ Per 100
FHM06	6	50	8	22	50	3.12	56.77
FHM08	8	60	10	30	50	3.84	85.83
FHM10	10	73	12	36	25	7.38	152.37
FHM12	12	90	16	47	10	16.76	258.94



FORGED EYE BOLTS

- ✓ Forging Process Helps Offer Strength When Load Is Applied
- ✓ Minimum 5µm

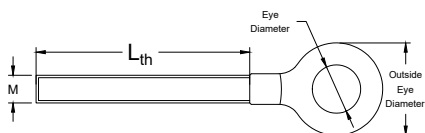

M=Thread Diameter L_{th} =Thread Length

**BRIGHT ZINC
PLATED**

Part Number	Thread Diameter M	Thread Length mm L_{th}	Eye Diameter mm	Outside Eye Diameter mm	Quantity Per Box	Ship Wt.kg Per 100	Price £ Per 100
FEM06	6	50	10	19	50	3.12	77.52
FEM08	8	60	11	23	50	3.15	107.36
FEM10	10	73	14	28	25	6.22	164.19
FEM12	12	90	16	34	10	11.17	279.01



SCAFFOLD RING BOLTS

Used together with M16 drop in anchors or M16 internal threaded sockets for restraining scaffolding.

- ✔ Cracked Concrete Over C20/25 To C50/60
- ✔ Non-Cracked Concrete Over C20/25
- ✔ Tested To Excess Of 1275kgs

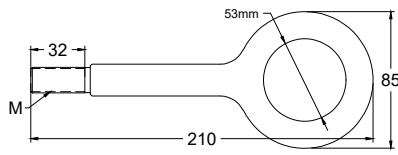

M=Thread Diameter

Part Number	Thread Diameter M	Thread Length mm	Eye Diameter mm	Overall Length mm	Quantity Per Box	Ship Wt.kg Per Each	Price £ Per Each
DSRBM16	16	32	53	210	1	0.60	5.38



SCAFFOLD RETAINING EYES

- ✔ Can Be Used In Concrete, Masonry And Natural Stone
- ✔ Re-Useable

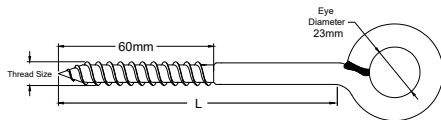

L= Shank and Thread Length

Part Number	Thread Diameter mm	Thread Length mm	Eye Internal Diameter mm	Shank and Thread Length mm L	Quantity Per Box	Ship Wt.kg Per 100	Price £ Per 100
SRE12120	12	60	24	120	20	17.20	185.19
SRE12160	12	60	24	160	10	20.40	222.22



SCAFFOLD EYE PLUGS

- ✔ Can Be Used In Concrete, Masonry And Natural Stone

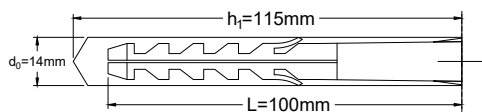

d₀=Anchor Hole Size L=Overall Length h₁=Minimum Hole Depth

Part Number	Anchor Hole Size mm d ₀	Overall Length mm L	Minimum Hole Depth mm h ₁	Quantity Per Box	Ship Wt.kg Per 100	Price £ Per 100
SRP14100	14	100	115	20	0.90	16.67



HEAVY DUTY EXPANSION ANCHORS

A high-performance heavy-duty torque-controlled anchor with a three part expansion sleeve allowing for smaller spacings and edge distances.

- ✔ Fast And Secure Installation
- ✔ Three Way Expansion Sleeve
- ✔ Reaction To Fire Class A1
- ✔ High-Performance
- ✔ Through Fixing

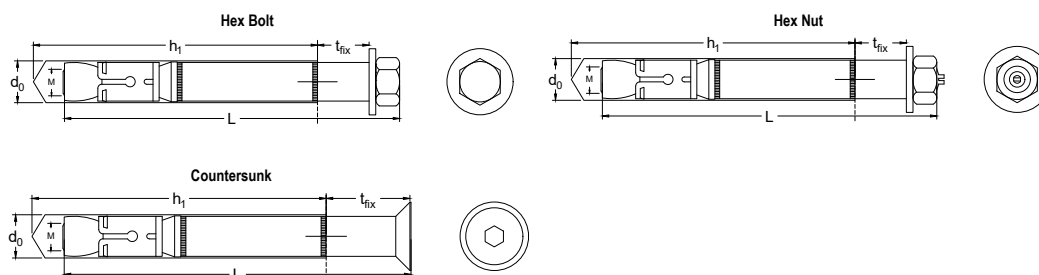

d_0 =Anchor Hole Size M=Thread Diameter L=Anchor Length t_{fix} =Maximum Fixture Thickness h_1 =Minimum Hole Depth



ETA OPTION 1 HEXAGON BOLT HEAVY DUTY ANCHORS BZP



- ✔ Concrete C20/25 To C50/60
- ✔ Cracked Concrete
- ✔ Non-Cracked Concrete
- ✔ Fire Resistance Loading
- ✔ Minimum 5µm

**BRIGHT ZINC
PLATED**

Part Number	Anchor Hole Size mm d_0	Thread Diameter M	Anchor Length mm L	Max Fixture Thickness mm t_{fix}	Minimum Hole Depth mm h_1	Quantity Per Box	Ship Wt.kg Per 100	Price £ Per 100
JHD0610	10	6	75	10	65	50	5.50	129.57
JHD0630	10	6	95	30	65	50	7.50	140.02
JHD0650	10	6	115	50	65	50	8.30	147.78
JHD0810	12	8	85	10	80	50	9.90	163.01
JHD0830	12	8	105	30	80	50	10.50	183.91
JHD0850	12	8	125	50	80	25	11.70	197.34
JHD1015	15	10	106	15	95	25	12.50	236.45
JHD1025	15	10	116	25	95	25	15.50	249.89
JHD1045	15	10	136	45	95	25	18.00	290.49
JHD1210	18	12	117	10	105	20	21.50	362.74
JHD1220	18	12	127	20	105	20	24.50	421.26
JHD1240	18	12	147	40	105	20	29.50	443.05
JHD1270	18	12	177	70	105	20	30.50	499.77
JHD1610	24	16	130	10	130	10	45.50	755.93
JHD1620	24	16	150	20	130	10	52.50	757.42
JHD1650	24	16	180	50	130	10	58.50	877.44
JHD2030	28	20	192	30	160	5	93.33	1,424.68
JHD2060	28	20	222	60	160	5	107.50	1,683.53
JHD2460	32	24	262	60	180	5	144.20	4,269.28



ETA OPTION 1 STUD AND NUT HEAVY DUTY ANCHORS BZP



- Concrete C20/25 To C50/60
 Cracked Concrete
 Non-Cracked Concrete
 Fire Resistance Loading
 Minimum 5µm

BRIGHT ZINC PLATED

Part Number	Anchor Hole Size mm d_0	Thread Diameter M	Anchor Length mm L	Max Fixture Thickness mm t_{fix}	Minimum Hole Depth mm h_1	Quantity Per Box	Ship Wt.kg Per 100	Price £ Per 100
NHD0810	12	8	90	10	80	50	6.60	168.38
NHD0830	12	8	110	30	80	50	8.00	183.31
NHD0850	12	8	130	50	80	25	10.00	198.83
NHD1015	15	10	111	15	95	25	12.80	240.93
NHD1025	15	10	121	25	95	25	14.00	258.84
NHD1045	15	10	141	45	95	25	16.00	295.86
NHD1210	18	12	122	10	105	20	20.50	382.14
NHD1220	18	12	132	20	105	20	22.00	412.30
NHD1240	18	12	152	40	105	20	25.50	463.35
NHD1270	18	12	182	70	105	20	30.50	514.10
NHD1620	24	16	157	20	130	10	47.00	809.97
NHD1650	24	16	187	50	130	10	55.00	901.03



ETA OPTION 1 COUNTERSUNK HEAD HEAVY DUTY ANCHORS BZP



- Concrete C20/25 To C50/60
 Cracked Concrete
 Non-Cracked Concrete
 Fire Resistance Loading
 Minimum 5µm

BRIGHT ZINC PLATED

Part Number	Anchor Hole Size mm d_0	Thread Diameter M	Anchor Length mm L	Max Fixture Thickness mm t_{fix}	Minimum Hole Depth mm h_1	Head Diameter mm	Quantity Per Box	Ship Wt.kg Per 100	Price £ Per 100
SLSK10/10	10	6	70	10	65	18	50	3.70	242.00
SLSK10/25	10	6	85	25	65	18	50	4.50	254.00
SLSK10/45	10	6	100	40	65	18	50	6.20	276.00
SLSK12/10	12	8	80	10	80	20	50	6.40	290.33
SLSK12/25	12	8	95	25	80	20	50	7.70	312.00
SLSK12/50	12	8	120	50	80	20	25	9.60	341.33
SLSK15/10*	15	10	95	10	95	25	25	11.00	393.33
SLSK15/25*	15	10	110	25	95	25	25	12.60	420.00
SLSK15/50*	15	10	135	50	95	25	25	15.60	480.33
SLSK18/20	18	12	115	20	105	30	20	21.00	636.00
SLSK18/40	18	12	135	40	105	30	20	25.00	717.33

* Torx T50 Drive



ETA OPTION 1 HEXAGON BOLT HEAVY DUTY ANCHORS A4 STAINLESS STEEL



- Concrete C20/25 To C50/60
 Cracked Concrete
 Non-Cracked Concrete
 Fire Resistance Loading
 Suitable For External Use And Marine Environments

A4-316 STAINLESS STEEL

Part Number	Anchor Hole Size mm d_0	Thread Diameter M	Anchor Length mm L	Max Fixture Thickness mm t_{fix}	Minimum Hole Depth mm h_1	Quantity Per Box	Ship Wt.kg Per 100	Price £ Per 100
JHD0810SS	12	8	85	10	80	50	6.62	1,035.64
JHD0830SS	12	8	105	30	80	50	8.20	1,174.96
JHD0850SS	12	8	125	50	80	25	9.88	1,531.23
JHD1015SS	15	10	106	15	95	25	13.24	1,538.86
JHD1025SS	15	10	116	25	95	25	14.36	1,680.18
JHD1045SS	15	10	136	45	95	25	16.80	2,248.09
JHD1210SS	18	12	117	10	105	20	20.90	2,407.65
JHD1225SS	18	12	127	20	105	20	22.65	2,638.19
JHD1240SS	18	12	147	40	105	20	26.05	2,862.44



ETA OPTION 1 STUD AND NUT HEAVY DUTY ANCHORS A4 STAINLESS STEEL



A4-316 STAINLESS STEEL

- Concrete C20/25 To C50/60
- Cracked Concrete
- Non-Cracked Concrete
- Fire Resistance Loading
- Suitable For External Use And Marine Environments

Part Number	Anchor Hole Size mm d_0	Thread Diameter M	Anchor Length mm L	Max Fixture Thickness mm t_{fix}	Minimum Hole Depth mm h_1	Quantity Per Box	Ship Wt.kg Per 100	Price £ Per 100
SLB12/10SS	12	8	90	10	80	50	6.40	1,035.64
SLB12/30SS	12	8	110	30	80	50	7.70	1,174.96
SLB14/15SS	15	10	111	15	95	25	11.00	1,538.86
SLB14/25SS	15	10	121	25	95	25	12.60	1,680.18
SLB18/20SS	18	12	132	20	105	20	23.00	2,407.65
SLB18/40SS	18	12	152	40	105	20	25.00	2,638.19



ETA OPTION 1 COUNTERSUNK HEAD HEAVY DUTY ANCHORS A4 STAINLESS STEEL



A4-316 STAINLESS STEEL

- Concrete C20/25 To C50/60
- Cracked Concrete
- Non-Cracked Concrete
- Fire Resistance Loading
- Suitable For External Use And Marine Environments

Part Number	Anchor Hole Size mm d_0	Thread Diameter M	Anchor Length mm L	Max Fixture Thickness mm t_{fix}	Minimum Hole Depth mm h_1	Head Diameter mm	Quantity Per Box	Ship Wt.kg Per 100	Price £ Per 100
SLSK12/10SS	12	8	80	10	80	20	50	6.02	1,640.37
SLSK12/25SS	12	8	95	25	80	20	50	7.30	1,750.83
SLSK12/50SS	12	8	120	50	80	20	25	9.32	1,842.72
SLSK15/15SS	15	10	100	15	95	25	25	11.16	2,061.66
SLSK15/25SS	15	10	110	25	95	25	25	13.16	2,185.06
SLSK15/50SS	15	10	135	50	95	25	25	15.84	2,793.44
SLSK18/20SS	18	12	115	20	105	30	20	19.95	3,914.33
SLSK18/40SS	18	12	135	40	105	30	20	23.10	4,146.21

The JCP Anchor Calculation Program is free to download via

www.jcpfixings.co.uk



BLIND BOLTS

BLINDBOLT® The Blind Bolt® is a constructional cavity fixing, suitable for fixing to steel sections where access is available from one side only, with the unique design reducing installation time and expense.

HDBOLT® With its expanding base and unique pin locking mechanism, the Heavy Duty Blind Bolt is the ideal fixing solution between heavyweight steel sections, with the unique design reducing installation time and expense.

TWBOLT® The Thin Wall Bolt is for blind fixing to lightweight sheet steel or cladding material, offering a neat, low profile head with no stud protrusion.

- ✔ Fast And Secure Installation
- ✔ Reaction To Fire Class A1
- ✔ High-Performance
- ✔ Installation And Removal Video's Available

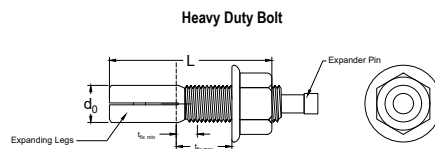
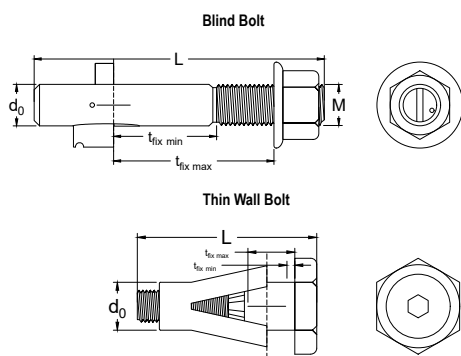

d_0 =Hole Diameter M=Bolt Size L=Length $t_{fix\ min}$ =Minimum Fixture Thickness $t_{fix\ max}$ =Maximum Fixture Thickness

BLIND BOLTS ZINC FLAKE



- ✔ Removable
- ✔ Property Class 10.9
- ✔ Design Values To BS 5950-1
- ✔ Design Values To EN 1993-1-8
- ✔ Re-Useable
- ✔ Horizontal And Vertically Down Positions
- ✔ 1000 Hour Salt Spray Protection

**ZINC
FLAKE**

Part Number	Hole Diameter mm d_0	Bolt Size M	Length mm L	Min Fixture Thickness mm $t_{fix\ min}$	Max Fixture Thickness mm $t_{fix\ max}$	Quantity Per Box	Ship Wt.Kg Per 100	Price £ Per Each
BB08050ZF	9	8	50	9	24	50	2.00	2.50
BB10060ZF	11	10	60	10	30	40	4.00	2.77
BB10095ZF	11	10	95	25	65	20	7.00	4.23
BB10130ZF	11	10	130	55	100	20	9.00	4.38
BB12070ZF	13	12	70	12	35	20	8.00	3.67
BB14075ZF	15	14	75	14	35	25	10.00	5.75
BB14125ZF	15	14	125	28	82	20	15.00	7.47
BB14185ZF	15	14	185	75	142	15	19.00	11.08
BB30140ZF*	32	30	140	27	60	5	94.00	28.57

* It is strongly recommended to use the installation gauge when installing these bolts.



BLIND BOLTS HDG

**HOT DIPPED
GALVANISED**

- Removable
- Property Class 10.9
- Design Values To BS 5950-1
- Design Values To EN 1993-1-8
- Re-Useable
- Horizontal And Vertically Down Positions

Part Number	Hole Diameter mm d_0	Bolt Size M	Length mm L	Min Fixture Thickness mm $t_{fix\ min}$	Max Fixture Thickness mm $t_{fix\ max}$	Quantity Per Box	Ship Wt.Kg Per 100	Price £ Per Each
BB12070HDG	13	12	70	12	35	20	8.00	3.95
BB12120HDG	13	12	120	30	85	25	11.00	5.80
BB12180HDG	13	12	180	80	140	20	17.00	6.98
BB16090HDG*	17	16	90	13	43	20	17.00	7.10
BB16130HDG*	17	16	130	40	75	15	21.00	9.80
BB16180HDG*	17	16	180	55	125	10	29.00	12.77
BB20110HDG*	22	20	110	21	56	10	33.00	13.47
BB20140HDG*	22	20	140	21	86	8	40.00	14.63
BB20180HDG*	22	20	180	80	120	10	45.00	16.25
BB20250HDG*	22	20	250	130	185	10	60.00	20.57
BB24130HDG*	26	24	130	21	66	5	52.00	20.47

* It is strongly recommended to use the installation gauge when installing these bolts.



BLIND BOLTS A4 STAINLESS STEEL

**A4-70
STAINLESS STEEL**

- Re-Useable
- Horizontal And Vertically Down Positions

Part Number	Hole Diameter mm d_0	Bolt Size M	Length mm L	Min Fixture Thickness mm $t_{fix\ min}$	Max Fixture Thickness mm $t_{fix\ max}$	Quantity Per Box	Ship Wt.Kg Per 100	Price £ Per Each
BB08050A4	9	8	50	9	24	50	2.00	6.73
BB10060A4	11	10	60	10	30	40	4.00	9.00
BB12090A4	13	12	90	12	55	20	9.00	10.52
BB16100A4	17	16	100	13	53	20	18.00	17.87



HEAVY DUTY BLIND BOLTS ZINC FLAKE

**ZINC
FLAKE**

- Property Class 8.8
- No Over-Sized Hole Required
- Increased Assembly Efficiency
- Unique Pin Locking Design
- 1000 Hour Salt Spray Protection

Part Number	Hole Diameter mm d_0	Bolt Size M	Length mm L	Min Fixture Thickness mm $t_{fix\ min}$	Max Fixture Thickness mm $t_{fix\ max}$	Quantity Per Box	Ship Wt.Kg Per 100	Price £ Per Each
BBHD0845ZF	8	8	45	7	25	50	2.00	2.53
BBHD1045ZF	10	10	45	7	25	40	4.00	2.80
BBHD1060ZF	10	10	60	7	40	40	4.00	2.87
BBHD1245ZF	12	12	45	8	22	20	7.00	3.13
BBHD1260ZF	12	12	60	8	37	20	7.00	3.32
BBHD1275ZF	12	12	75	8	52	20	11.00	4.77
BBHD1660ZF	16	16	60	12	30	20	13.00	6.95
BBHD1675ZF	16	16	75	12	45	20	15.00	7.12
BBHD2070ZF	20	20	70	15	32	10	23.00	12.02
BBHD2085ZF	20	20	85	15	47	10	28.00	12.70



HEAVY DUTY BLIND BOLTS A4 STAINLESS STEEL

**A4-70
STAINLESS STEEL**

- No Over-Sized Hole Required
 Increased Assembly Efficiency
 Unique Pin Locking Design

Part Number	Hole Diameter mm d_0	Bolt Size M	Length mm L	Min Fixture Thickness mm $t_{fix\ min}$	Max Fixture Thickness mm $t_{fix\ max}$	Quantity Per Box	Ship Wt.Kg Per 100	Price £ Per Each
BBHD0845A4	8	8	45	7	25	50	2.00	4.95
BBHD1045A4	10	10	45	7	25	40	4.00	5.88
BBHD1060A4	10	10	60	7	40	40	4.00	7.08
BBHD1245A4	12	12	45	8	22	20	7.00	7.18
BBHD1260A4	12	12	60	8	37	20	7.00	8.98
BBHD1660A4	16	16	60	12	30	20	13.00	15.78
BBHD2070A4	20	20	70	15	32	10	23.00	21.55



THIN WALL BLIND BOLTS ZINC NICKEL

ZINC NICKEL

- No Over-Sized Hole Required
 High Shear Capacity
 Low Profile Head

Part Number	Hole Diameter mm d_0	Length mm L	Min Fixture Thickness mm $t_{fix\ min}$	Max Fixture Thickness mm $t_{fix\ max}$	Quantity Per Box	Ship Wt.Kg Per 100	Price £ Per Each
BBTW0810ZN	8	35	2	10	100	1.50	2.43
BBTW0816ZN	8	40	8	16	100	1.65	3.07
BBTW1010ZN	10	40	2	10	50	1.30	3.17
BBTW1016ZN	10	45	8	16	50	1.40	3.87
BBTW1310ZN	13	45	2	10	50	2.50	6.67
BBTW1316ZN	13	50	8	16	50	2.80	7.73



THIN WALL BLIND BOLTS A2 STAINLESS STEEL

**A2-70
STAINLESS STEEL**

- No Over-Sized Hole Required
 High Shear Capacity
 Low Profile Head

Part Number	Hole Diameter mm d_0	Length mm L	Min Fixture Thickness mm $t_{fix\ min}$	Max Fixture Thickness mm $t_{fix\ max}$	Quantity Per Box	Ship Wt.Kg Per 100	Price £ Per Each
BBTW0810SS	8	35	2	10	100	1.50	4.00
BBTW0816SS	8	40	8	16	100	1.65	4.63
BBTW1010SS	10	40	2	10	50	1.62	5.20
BBTW1016SS	10	45	8	16	50	1.86	6.40
BBTW1310SS	13	45	2	10	50	1.58	9.68
BBTW1316SS	13	50	8	16	50	1.71	11.77



BLINDBOLT®

THE SMART SOLUTION FOR STEELWORK CONNECTIONS

A simple yet ingenious solution for connections with access from one side only. Blind bolts are a fully tested assembly for 'blind' fixings to hollow sections and other applications with one-sided access, carrying shear and/or tension. Simple to install, check and tighten – and remove if required.

- Quick and easy to install from one side
- Designed for ordinary clearance holes
- A true removable blind fixing available for structural connections
- Fully tested by the SCI

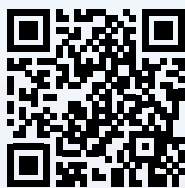

Watch the downward installation video here

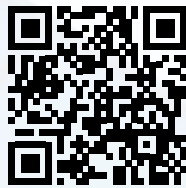

Watch the vertical installation video here

Also Available

HDBOLT®



TWBOLT®

APPLICATIONS

- Hollow sections
- Girders and beams
- Masonry support systems
- Cladding and façades
- Marine



Full technical details, design resistances and SCI report available from www.blindbolt.co.uk



INJECTION RESINS AND GLASS CAPSULES

Chemical Anchors used for installing threaded studs, rebar or internal threaded sockets for structural applications.



- High Performance
- Good, Better, Best Options Available

J-FIX PURE EPOXY RESIN



Pure epoxy resin is a 3:1 ratio resin with very high load capacities, and is approved for use in contact with potable (drinking) water. Suitable for use in the majority of base materials.



- ETA Option 1
- Concrete C20/25 To C50/60
- Cracked Concrete
- Non-Cracked Concrete
- 100 Years Working Life
- Dry/Wet/Flooded Holes
- Expansion Free
- Close Spacing And Edge Distance

Part Number	Description	Volume ml	Quantity Unit/Box	Ship Wt.Kg Each	Price £ Per Each
JF375E	Red Pure Epoxy Resin in Cartridge + 1 Mixer Nozzle	385	1/10	0.75	22.85

J-FIX ULTRA-BOND 100 EPOXY RESIN



Ultra-Bond 100 epoxy resin is a formulation derived from pure epoxy with very high bond strength. The two-component chemical anchoring injection system in a 3:1 ratio can achieve high loads and is used for high-performance structural applications where loading is critical.



- ETA Option 1
- Our Highest-Strength Resin
- Concrete C20/25 To C50/60
- Cracked Concrete
- Non-Cracked Concrete
- 100 Years Working Life
- Dry/Wet/Flooded Holes
- Expansion Free
- Close Spacing And Edge Distance

Part Number	Description	Volume ml	Quantity Unit/Box	Ship Wt.Kg Each	Price £ Per Each
JF585E	Red Ultra-Bond Epoxy Resin in Cartridge + 1 Mixer Nozzle	585	10	1.05	32.75



J-FIX ULTRA-BOND 100 EPOXY RESIN



585ml

ETA Option 1 approved, the J-Fix Ultra Bond 100 is suitable for high loads featuring large diameters and deep embedment. Longer working times make it ideal for large holes and high temperatures.

It is also approved for use under seismic actions C1 and C2. Offering high durability and resistance to chemicals, Ultra-Bond 100 is a low-emitting material and qualified to be categorised as LEED v4 and v4.1 Beta according to ISO 16000, EN 16516, ISO 11890-2 and ASTM D2369 testing standards.









- 24 Month Shelf Life From Date of Manufacture
- Ideal for Rotary Hammer Drilled Dry and Wet Holes
- Longer Working Times for Large Holes and High Temperatures

J-FIX VINYLESTER RESIN



Pure vinylester resin is a high strength resin, which can be used in dry, damp, and flooded holes, and comes complete with a WRAS Approval number.



- ETA Option 1
- ETA For Masonry
- Concrete C20/25 To C50/60
- Cracked Concrete
- Non-Cracked Concrete
- 100 Years Working Life
- Styrene Free
- Dry/Wet/Flooded Holes
- Expansion Free
- Close Spacing And Edge Distance

Part Number	Description	Volume ml	Quantity Unit/Box	Ship Wt.Kg Each	Price £ Per Each
JFV380SF	Vinylester High Load Resin in Cartridge + 1 Mixer Nozzle	410	1/12	0.79	16.19
JFV300SF	Vinylester High Load Resin in Cartridge + 1 Mixer Nozzle	300	1/12	0.70	12.48

J-FIX VINYLESTER FAST CURE WINTER GRADE RESIN



Winter grade vinylester resin can be used in temperatures down to -20°C or as a fast cure resin in warmer temperatures.



- ETA Option 1
- ETA For Masonry
- Concrete C20/25 To C50/60
- Cracked Concrete
- Non-Cracked Concrete
- Winter Grade
- 100 Years Working Life
- Styrene Free
- Dry/Wet/Flooded Holes
- Expansion Free
- Close Spacing And Edge Distance

Part Number	Description	Volume ml	Quantity Unit/Box	Ship Wt.Kg Each	Price £ Per Each
JFEA410SFW	Winter Grade Vinylester Resin in Cartridge + 1 Mixer Nozzle	410	1/12	0.79	17.33

J-FIX EPOXY ACRYLATE RESIN



Epoxy acrylate resin is suitable for use in non-cracked concrete, other base materials and in damp conditions.

- ETA Option 7
- Concrete C20/25 To C50/60
- Non-Cracked Concrete
- Styrene Free
- Dry/Wet/Flooded Holes
- Expansion Free
- Close Spacing And Edge Distance

Part Number	Description	Volume ml	Quantity Unit/Box	Ship Wt.Kg Each	Price £ Per Each
JFEA380SF	Grey Styrene Free Epoxy Acrylate Resin in Cartridge + 1 Mixer Nozzle	410	1/12	0.79	13.37

J-FIX POLYESTER STYRENE FREE RESIN



Polyester styrene free resin is a general purpose resin suitable for brickwork, most natural stone, and concrete.

- ETA Option 7
- Concrete C20/25 To C50/60
- Non-Cracked Concrete
- Styrene Free
- Dry/Wet/Flooded Holes
- Expansion Free
- Close Spacing And Edge Distance

Part Number	Description	Volume ml	Quantity Unit/Box	Ship Wt.Kg Each	Price £ Per Each
JF380PSF	Grey Styrene Free Polyester Resin in Cartridge + 1 Mixer Nozzle	410	1/12	0.79	10.81
JFEA300SF	Grey Styrene Free Polyester Resin in Cartridge + 1 Mixer Nozzle	300	1/12	0.69	9.26
JF150P	Grey Styrene Free Polyester Resin in Cartridge + 2 Mixer Nozzles	150	1/12	0.42	8.63



J-FIX POLYESTER RESIN



Polyester resin is a general purpose resin suitable for brickwork, most natural stone and concrete.

- ETA Option 7
- Concrete C20/25 To C50/60
- Non-Cracked Concrete
- Dry/Wet/Flooded Holes
- Expansion Free
- Close Spacing And Edge Distance

Part Number	Description	Volume ml	Quantity Unit/Box	Ship Wt.Kg Each	Price £ Per Each
JF380P	Grey Polyester Resin in Cartridge + 1 Mixer Nozzle	410	1/12	0.79	9.93

APPROXIMATE RESIN FIXING PER CARTRIDGE

Thread Diameter mm	Hole Size mm	Hole Depth mm	410ml	375ml	300ml	150ml
M8	10	80	78	71	57	25
M10	12	90	52	48	38	17
M12	14	110	34	31	25	11
M16	18	125	22	20	16	7
M20	22	170	11	10	8	3
M24	26	210	7	6	5	2



J-FIX SPIN-IN GLASS CAPSULES

The spin in glass capsule anchor contains a quartz aggregate and is used with threaded studs to provide a stress free anchorage in concrete, offering exceptional load capability.

- ETA Option 7
- Non-Cracked Concrete
- Good Resistance To Vibrating Loads
- Can Be Used In Wet And Corrosive Environment
- Expansion Free
- Epoxy Acrylate



Part Number	Thread Diameter mm	Length mm	Max Fixture Thickness mm	Hole Diameter mm	Min Hole Depth mm	Quantity Per Box	Ship Wt.Kg Per 100	Price £ Per 100
JCAPSM08	8	80	9	10	80	10	1.20	113.10
JCAPSM10	10	80	11	12	90	10	1.30	113.10
JCAPSM12	12	95	13	14	110	10	2.40	115.10
JCAPSM16	16	95	17	18	125	10	3.30	130.71
JCAPSM20	20	160	17	22	170	10	10.90	246.35
JCAPSM24	24	175	22	26	210	10	14.10	284.00
JCAPSM30	30	230	25	32	280	5	28.20	530.46



J-FIX HAMMER-IN GLASS CAPSULES

The epoxy acrylate hammer in capsules are suitable for use in solid concrete and natural stone, and can be used with reinforcing bar or threaded rods, achieving high loads by using two capsules at double embedment depth.

- Increased Embedment Depth
- Expansion Free
- Exact Resin Quantity Per Hole
- Rapid Installation
- For Use With Rebar/Flat Ended Studs

Part Number	Rebar Nominal Diameter mm	Thread Diameter mm	Capsule Diameter mm	Capsule Length mm	Min Hole Depth mm	Quantity Per Box	Ship Wt.Kg Per 100	Price £ Per 100
JCAPHM10	10	10	11	90	100	10	1.30	133.23
JCAPHM12	12	12	13	110	110	10	2.40	141.13
JCAPHM16	16	16	17	125	125	10	3.30	159.39
JCAPHM20	20	20	22	175	200	6	10.90	306.49
JCAPHM24	25	24	24	210	250	6	14.10	359.01
JCAPHM30	32	30	33	265	300	6	28.20	681.50



ANCHORING CEMENTS

ROCKITE (INTERIOR GRADE)

Rockite is a fast-setting hydraulic expansion cement. When mixed with water it provides a compound that can be used internally for grouting, anchoring or patching. 1kg (2.2lb) dry powder weight fills approximately 700 cubic centimetres.



- Fast Setting
- Crack-Free Finish
- Mix With Water
- Expanding

Part Number	Description	Quantity	Ship Wt.Kg Each	Price £ Per Each
57 9020	0.45kg (1lb) Carton	1	0.45	3.70
57 9002	2.27kg (5lb) Carton	1	2.27	14.21
57 9003	4.54kg (10lb) Pail	1	4.54	26.49
57 9004	22.70kg (50lb) Carton	1	22.70	100.85
57 9005	22.70kg (50lb) Pail	1	22.70	113.46



PAIL



CARTON

KWIXSET (EXTERIOR GRADE)

Kwixset is a fast-setting hydraulic type cement for external or internal use.

- Fast Setting
- Ideal For External Or Internal Use
- No Further Treatment Required For External Use
- Expanding



Part Number	Description	Quantity	Ship Wt.Kg Each	Price £ Per Each
57 9011	11.35kg (25lb) Pail	1	11.35	72.17
57 9012	22.70kg (50lb) Pail	1	22.70	135.93

Caution: Rockite and Kwixset have very strong expansion properties which generate the high tensile loads that can be achieved and as such their use in hollow bricks or blocks is not recommended.



THREADED STUDS AND SOCKETS

For use with J-Fix Spin-In Glass Capsules or J-Fix Injection Resin Systems.

- Plain Ended For Injection Resin Only
- Chisel Ended For Injection Resin And Glass Capsules
- Chisel Ended Studs Come Complete With Setting Tool For Glass Capsules

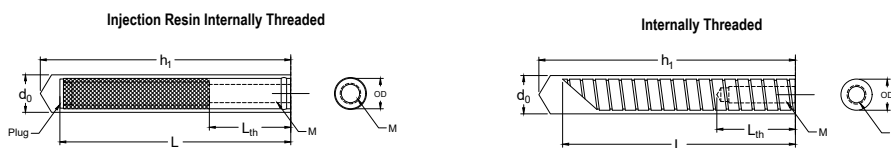
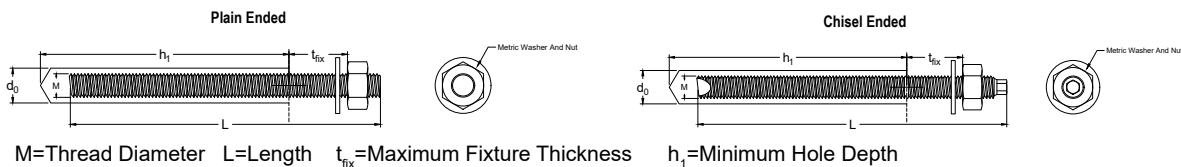

M=Internal Thread Diameter L_{th} =Internal Thread Length d_0 =Hole Diameter L=Anchor Length h_1 =Minimum Hole Depth



J-FIX STUDS BZP



- Chisel Point
- Grade 5.8 Threaded Stud
- Depth Mark Indicates Embedment Depth At Standard Embedment
- Minimum 5µm

BRIGHT ZINC PLATED

Part Number	Thread Diameter M	Length mm L	Max Fixture Thickness mm t_{fix}	Min Hole Depth mm h_1	Quantity Per Box	Ship Wt.Kg Per 100	Price £ Per 100
JSTUD08110	8	110	18	80	10	4.30	35.67
JSTUD10130	10	130	25	90	10	7.75	51.52
JSTUD12160	12	160	34	110	10	13.30	77.79
JSTUD16190	16	190	45	125	10	28.50	153.45
JSTUD20260	20	260	55	170	10	62.00	299.47
JSTUD24300	24	300	55	210	5	102.00	494.38
JSTUD30380	30	380	55	280	5	164.00	980.58



J-FIX STUDS PLAIN ENDED BZP

BRIGHT ZINC PLATED

- Plain Ended
- Grade 5.8 Threaded Stud
- Minimum 5µm

Part Number	Thread Diameter M	Length mm L	Max Fixture Thickness mm t_{fx}	Min Hole Depth mm h_1	Quantity Per Box	Ship Wt.Kg Per 100	Price £ Per 100
JSTUD08150PE	8	150	62	80	10	4.00	40.22
JSTUD10105PE	10	105	5	90	10	7.20	59.11
JSTUD10150PE	10	150	50	90	10	7.70	62.99
JSTUD10200PE	10	200	100	90	10	11.10	75.83
JSTUD12110PE	12	110	-	-	10	9.90	63.34
JSTUD12150PE	12	150	27	110	10	12.70	85.58
JSTUD12200PE	12	200	77	110	10	16.20	107.25
JSTUD16110PE	16	110	-	-	10	18.50	131.36
JSTUD16250PE	16	250	104	128	10	36.70	217.58
JSTUD16350PE	16	350	204	128	10	49.70	274.03
JSTUD20200PE	20	200	9	170	10	48.40	299.16
JSTUD20400PE	20	400	209	170	10	89.20	475.16



J-FIX STUDS ZYP - HIGH TENSILE

ZINC AND YELLOW PLATED

- Chisel Point
- High Tensile Grade 8.8 Threaded Stud
- Depth Mark Indicates Embedment Depth At Standard Embedment
- Minimum 5µm

Part Number	Thread Diameter M	Length mm L	Max Fixture Thickness mm t_{fx}	Min Hole Depth mm h_1	Quantity Per Box	Ship Wt.Kg Per 100	Price £ Per 100
JSTUD08110HT	8	110	18	80	10	4.30	41.73
JSTUD10130HT	10	130	25	90	10	7.75	61.58
JSTUD12160HT	12	160	34	110	10	13.30	95.28
JSTUD16190HT	16	190	45	125	10	28.50	188.76
JSTUD20260HT	20	260	55	170	10	62.00	378.27
JSTUD24300HT	24	300	55	210	5	102.00	614.16
JSTUD30380HT	30	380	55	280	5	164.00	1,221.19



J-FIX STUDS GALV

HOT DIPPED GALVANISED

- Chisel Point
- Grade 5.8 Threaded Stud
- Depth Mark Indicates Embedment Depth At Standard Embedment
- BS EN ISO 1461:2009

Part Number	Thread Diameter M	Length mm L	Max Fixture Thickness mm t_{fx}	Min Hole Depth mm h_1	Quantity Per Box	Ship Wt.Kg Per 100	Price £ Per 100
JSTUD08110G	8	110	18	80	10	4.40	42.42
JSTUD10130G	10	130	25	90	10	7.90	64.95
JSTUD12160G	12	160	34	110	10	13.50	97.61
JSTUD16190G	16	190	45	125	10	29.00	190.43
JSTUD20260G	20	260	55	170	5	63.40	374.60
JSTUD24300G	24	300	55	210	5	104.20	605.75



FREE, NEXT-DAY DELIVERY WITH LOW MINIMUM ORDER LEVELS ACROSS THE MAJORITY OF THE UK MAINLAND.



J-FIX STUDS GALV - HIGH TENSILE

HOT DIPPED GALVANISED

- Chisel Point High Tensile Grade 8.8 Threaded Stud
- Depth Mark Indicates Embedment Depth At Standard Embedment BS EN ISO 1461:2009

Part Number	Thread Diameter M	Length mm L	Max Fixture Thickness mm t_{fix}	Min Hole Depth mm h_1	Quantity Per Box	Ship Wt.Kg Per 100	Price £ Per 100
JSTUD08110GHT	8	110	18	80	10	4.40	58.00
JSTUD10130GHT	10	130	25	90	10	7.90	86.05
JSTUD12160GHT	12	160	34	110	10	13.50	127.53
JSTUD16190GHT	16	190	45	125	10	29.00	245.79
JSTUD20260GHT	20	260	55	170	5	63.40	497.64
JSTUD24300GHT	24	300	55	210	5	104.20	840.52



J-FIX STUDS A2 STAINLESS STEEL

A2-304 STAINLESS STEEL

- Chisel Point Grade 70 Stainless Steel Threaded Stud
- Depth Mark Indicates Embedment Depth At Standard Embedment Suitable For External Use

Part Number	Thread Diameter M	Length mm L	Max Fixture Thickness mm t_{fix}	Min Hole Depth mm h_1	Quantity Per Box	Ship Wt.Kg Per 100	Price £ Per 100
JSTUD08110SS	8	110	18	80	10	4.32	117.73
JSTUD10130SS	10	130	25	90	10	7.77	193.99
JSTUD12160SS	12	160	34	110	10	13.30	324.93
JSTUD16190SS	16	190	45	125	10	28.50	675.13
JSTUD20260SS	20	260	55	170	5	62.00	1,392.74
JSTUD24300SS	24	300	55	210	5	102.00	2,264.65



J-FIX STUDS A4 STAINLESS STEEL

A4-316 STAINLESS STEEL

- Chisel Point Grade 70 Stainless Steel Threaded Stud
- Depth Mark Indicates Embedment Depth At Standard Embedment Suitable For External Use And Marine Environments

Part Number	Thread Diameter M	Length mm L	Max Fixture Thickness mm t_{fix}	Min Hole Depth mm h_1	Quantity Per Box	Ship Wt.Kg Per 100	Price £ Per 100
JSTUD08110SSA4	8	110	18	80	10	4.32	155.43
JSTUD10130SSA4	10	130	25	90	10	7.77	266.98
JSTUD12160SSA4	12	160	34	110	10	13.30	441.80
JSTUD16190SSA4	16	190	45	125	10	28.50	921.46
JSTUD20260SSA4	20	260	55	170	5	62.00	1,936.63
JSTUD24300SSA4	24	300	55	210	5	102.00	3,189.50



Available from
www.owlett-jaton.com

- Full range of allthread studs in sizes M4 to M12
- Studding in 1 metre and 3 metre lengths

Owlett-Jaton



J-FIX STUDS PLAIN ENDED A4 STAINLESS STEEL



- Plain Ended Grade 70 Stainless Steel Threaded Stud
- Suitable For External Use And Marine Environments

**A4-316
STAINLESS STEEL**

Part Number	Thread Diameter M	Length mm L	Max Fixture Thickness mm t_{fix}	Min Hole Depth mm h_1	Quantity Per Box	Ship Wt.Kg Per 100	Price £ Per 100
JSTUD08150PESS	8	150	62	80	10	4.00	182.52
JSTUD10105PESS	10	105	5	90	10	7.20	220.61
JSTUD10150PESS	10	150	50	90	10	7.70	289.01
JSTUD10200PESS	10	200	100	90	10	11.10	356.54
JSTUD12110PESS	12	110	-	-	10	9.90	326.46
JSTUD12150PESS	12	150	27	110	10	12.70	399.85
JSTUD12200PESS	12	200	77	110	10	16.20	500.48
JSTUD16110PESS	16	110	-	-	10	18.50	584.87
JSTUD16250PESS	16	250	104	128	10	36.70	1,096.60
JSTUD16350PESS	16	350	204	128	10	49.70	1,444.78
JSTUD20200PESS	20	200	9	170	10	48.40	1,459.17
JSTUD20400PESS	20	400	209	170	10	89.20	2,622.10



INJECTION RESIN INTERNALLY THREADED SOCKETS BZP

**BRIGHT ZINC
PLATED**

- For Use In Solid Masonry/Brickwork Provides A Flush Fixing Use With Set Screws, Bolts Or Threaded Rod
- Allows Removal Of Bolt To Leave Re-Useable Socket Minimum 5µm

Part Number	Internal Thread M	Internal Thread Length mm L_{th}	Outside Diameter mm	Hole Diameter mm d_0	Anchor Length mm L	Min Hole Depth mm h_1	Quantity Per Box	Ship Wt.Kg Per 100	Price £ Per 100
INJM06	6	20	8	10	50	60	10	1.20	62.11
INJM08	8	25	12	14	80	90	10	4.20	89.09
INJM10	10	30	14	16	80	90	10	4.60	107.20
INJM12	12	30	16	18	80	90	10	5.40	122.83



INTERNAL THREADED SOCKETS BZP

**BRIGHT ZINC
PLATED**

- Provides A Flush Fixing Expansion Free High Loads
- Permanent Threaded Socket Allows Removal Of Bolt To Leave Re-Useable Socket Minimum 5µm

Part Number	Internal Thread M	Internal Thread Length mm L_{th}	Outside Diameter mm	Hole Diameter mm d_0	Anchor Length mm L	Min Hole Depth mm h_1	Quantity Per Box	Ship Wt.Kg Per 100	Price £ Per 100
ITSM08BZP	8	30	12	14	90	90	10	4.00	100.19
ITSM10BZP	10	35	16	18	90	90	10	7.00	143.23
ITSM12BZP	12	40	20	22	90	90	10	16.00	203.04
ITSM16BZP	16	40	24	28	125	125	10	29.00	379.12



INTERNAL THREADED SOCKETS A2 STAINLESS STEEL

**A2-304
STAINLESS STEEL**

- Provides A Flush Fixing Suitable for External Use Expansion Free High Loads
- Permanent Threaded Socket Allows Removal Of Bolt To Leave Re-Useable Socket Suitable For External Use

Part Number	Internal Thread M	Internal Thread Length mm L_{th}	Outside Diameter mm	Hole Diameter mm d_0	Anchor Length mm L	Min Hole Depth mm h_1	Quantity Per Box	Ship Wt.Kg Per 100	Price £ Per 100
ITSM08SS	8	30	12	14	90	90	10	4.00	291.77
ITSM10SS	10	35	16	18	90	90	10	7.00	454.72
ITSM12SS	12	40	20	22	90	90	10	16.00	669.48
ITSM16SS	16	40	24	28	125	125	10	29.00	1,298.19



INTERNAL THREADED SOCKETS A4 STAINLESS STEEL

**A4-316
STAINLESS STEEL**

- Provides A Flush Fixing
- Suitable For External Use And Marine Environments
- Expansion Free
- High Loads
- Permanent Threaded Socket
- Allows Removal Of Bolt To Leave Re-Useable Socket

Part Number	Internal Thread M	Internal Thread Length mm L _{th}	Outside Diameter mm	Hole Diameter mm d ₀	Anchor Length mm L	Min Hole Depth mm h ₁	Quantity Per Box	Ship Wt.Kg Per 100	Price £ Per 100
ITSM08SSA4	8	30	12	14	90	90	10	4.00	363.43
ITSM10SSA4	10	35	16	18	90	90	10	7.00	581.57
ITSM12SSA4	12	40	20	25	90	90	10	16.00	868.04
ITSM16SSA4	16	40	24	28	125	125	10	29.00	1,722.97



INJECTION RESIN ACCESSORIES

A range of injection resin accessories.

- For Use With The J-Fix Injection Resin Systems
- Compatible With Other Resins



INJECTION TOOLS

- Easy-To-Use
- Hand Operated

Part Number	Description	Ship Wt.Kg Per Each	Price £ Per Each
JTOOL150	For Any 150ml and 300ml Cartridge	0.60	6.58
JTOOL300	For Any 150ml and 300ml Cartridge	1.00	13.28
JTOOL375	For JF375E 385ml Cartridge	1.40	58.21
JTOOL380	For Any 410ml Cartridge	1.30	25.79
JTOOL410	For Any 410ml Cartridge	1.35	34.95
JTOOL600	For JF585E 585ml Cartridge	1.85	65.00

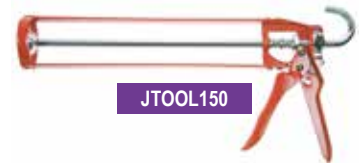

JTOOL150



JTOOL300



JTOOL375



JTOOL380



JTOOL410
NEW



JTOOL600

INJECTION TOOL ACCESSORIES

- Mixer Nozzles
- Extension Tube

Part Number	Description	Ship Wt.Kg Per Each	Price £ Per Each
1 JMN130	Mixer Nozzle	1.00	1.00
2 JMN190	Extension Tube for JMN130	1.00	0.90
3 JMN150E	Mixer Nozzle for JF375E and JF585E Pure Epoxy	1.00	1.65





NYLON SLEEVE WITH STUD ALIGNMENT COLLAR

- For Use With Injection Resin In Hollow Bricks And Blocks
- Perforated, Allowing The Resin To Evenly Permeate
- Stud Alignment Collar Aids With Accurate Positioning Of The Stud

Part Number	Hole Diameter mm	Sleeve Size mm	For Stud Size M	Quantity Per Bag	Ship Wt.Kg Per 100	Price £ Per 100
JNSLM08/12	16	15 x 85	8-12	10	0.18	22.89
JNSLM08/12L	16	15 x 130	8-12	10	0.18	25.94
JNSLM16	22	20 x 85	16	10	0.18	30.83



WIRE MESH SLEEVE

- Perforated, Allowing The Resin To Evenly Permeate
- Can Be Cut On Site To Required Length

Part Number	Hole Diameter mm	Inside Diameter mm	For Stud Size M	Length mm	Quantity Per Box	Ship Wt.Kg Per 100	Price £ Per Each
JMMSM08	12	8.7	M8	1000	1	6.00	6.22
JMMSM10/12	16	12.5	M10-M12	1000	1	8.00	6.94
JMMSM16	22	18.0	M16	1000	1	10.00	7.50
JMMSM20	26	22.0	M20	1000	1	12.00	7.89

WIRE CLEANING BRUSHES

- Cleaned Surfaces Ensure Optimum Bond Strength Of Fixing
- Hand Operated

Part Number	Brush Diameter mm	Pack Quantity	Price £ Per Each
CB08	8	1	4.62
CB10	10	1	6.05
CB12	12	1	6.43
CB16	16	1	7.14
CB20	20	1	7.62
CB25	25	1	7.38
CBW30	30	1	8.10
CBFW25	FLAT	1	8.10



Round Wire Brush

Flat Brush



BLOW OUT PUMP

Used to remove dust from holes prior to applying J-Fix Injection Resin Systems.

- Should Be Used After Application Of Round Wire Cleaning Brush
- Hand Operated

Part Number	Hole Diameter mm	Pack Quantity	Price £ Per Each
BOP1	10+	1	10.95



CRACK STITCHING ACCESSORIES

A range of crack stitching accessories for use when permanently repairing vertical or stepped cracks in masonry walls.



- Stabilises The Structure
- Helps Prevent Against Further Cracking
- Preserves Structural Integrity
- Non-Disruptive Repair Method

CRACK STITCH TWIST STARTER KIT

A complete system for reinforcing masonry and crack stitching.

KIT CONTAINS:

- 10 Lengths of 6mm x 1000mm Stitching Bar
- 1 x 3ltr Tub of Cementitious Grout
- 1 x 9.5mm Nozzle
- 1 x Crack Stitching Pointing Gun
- 1 x Mixing Paddle
- 1 x Finger Trowel



- Eliminates The Need To Rebuild A Wall
- Absorbs Further Localised Stress
- Minimises The Likelihood Of Further Cracking

Part Number	Description	Pack Quantity	Price £ Per Each
CSKIT	Crack Stitch Twist Starter Set	1	261.83

POINTING GUN

Crack-stitching pointing gun comes complete with cartridge, cone, and mortar nozzle.



- Enables Accurate Grout Application, Reducing Waste
- Hand Operated

Part Number	Description	Pack Quantity	Price £ Per Each
CSGUN	Crack Stitching Gun	1	65.63

MIXING PADDLE

For mixing grout, with a hexagon shaft ideal for power tool application.

- Quickly And Easily Mixes Grout
- Power-Tool Application



Part Number	Description	Pack Quantity	Price £ Per Each
CSMP	Mixing Paddle	1	11.04

STITCHING BAR

**A2-304
STAINLESS STEEL**

1 metre bar for use as masonry reinforcement and crack stitching.

- Eliminates The Need To Rebuild A Wall
- Absorbs Further Localised Stress
- Minimises The Likelihood Of Further Cracking

Part Number	Size mm	Quantity Per Box	Price £ Per Each
CS061000	6 x 1000	10	6.42
CS081000	8 x 1000	10	8.67



CEMENTITIOUS GROUT

Cementitious grout for use in crack stitching.

- Gives Excellent Flow For Easy Application
- Low Liquid To Powder Ratio Provides A Thixotropic Grout
- Free From Chlorides And Nitrates

Part Number	Size	Pack Quantity	Price £ Per Each
CSGROUT	3 Litre Tub	1	57.00



PU FOAMS AND ACCESSORIES

Ready-to-use construction foams, sealants and accessories for a wide variety of construction applications.

- Ready-To-Use
- Gun Grade Options
- Fire Resistance Options
- Effective Cavity Filling



B3 RATED EXPANDING FOAM

B3 rated expanding foam is a one-part, self-expanding, ready-to-use polyurethane construction foam designed for filling irregular gaps.

- Good Volume Expansion For Effective Filling
- Hand Held Aerosol And Gun Grade Cans
- Low Curing Pressure Avoids Deformation Of Building Elements
- CFC Free Propellant
- Excellent Adhesion
- High Thermal And Acoustic Insulation
- Excellent Mounting Capabilities
- Excellent Stability

Part Number	Description	Volume ml	Quantity Unit/ Box	Ship Wt.Kg Each	Price £ Per Each
JF750B3H	Grade B3 Hand Held Expanding Foam + 1 Nozzle	750	1/12	0.84	9.01
JF750B3G	Grade B3 Gun Applied Expanding Foam	750	1/12	0.84	9.34



B2 RATED EXPANDING FOAM

B2 rated expanding foam is a one-part, self-expanding, ready-to-use polyurethane construction foam suitable for use when joints must conform to BS EN ISO 471:2003 + A1:2007 (Part 20) DIN4102 (Part 1).

- ✔ Good Volume Expansion For Effective Filling
- ✔ Hand Held Aerosol And Gun Grade Cans
- ✔ High Thermal And Acoustic Insulation
- ✔ CFC Free Propellant
- ✔ Excellent Adhesion
- ✔ Excellent Stability
- ✔ Excellent Mounting Capabilities

Part Number	Description	Volume ml	Quantity Unit/ Box	Ship Wt.Kg Each	Price £ Per Each
JF750B2H	Grade B2 Hand Held Expanding Foam + 1 Nozzle	750	1/12	0.84	10.76
JF750B2G	Grade B2 Gun Applied Expanding Foam	750	1/12	0.84	10.76



JCP foam is a one part construction foam designed for filling irregular gaps. For B2 foams to achieve a fire rating class they must be used in conjunction with an approved fire rated sealant.

B1 RATED FIRE STOP EXPANDING FOAM

B1 rated expanding foam is a one-part, self-expanding, ready-to-use polyurethane construction foam designed for sealing joints in walls and service openings to prevent the passage of smoke and fire.



- ✔ Good Volume Expansion For Effective Filling
- ✔ Hand Held Aerosol And Gun Grade Cans
- ✔ Excellent Heat Resistance
- ✔ Can Provide Up To 4 Hours Fire Resistance
- ✔ High Thermal And Acoustic Insulation
- ✔ Resistant To Mould And Fungal Attack

Part Number	Description	Volume ml	Quantity Unit/ Box	Ship Wt.Kg Each	Price £ Per Each
JF750B1H	Grade B1 Hand Held Expanding Foam + 1 Nozzle	750	1/12	0.84	12.71
JF750B1G	Grade B1 Gun Applied Expanding Foam	750	1/12	0.84	12.71



**FREE, NEXT-DAY DELIVERY WITH LOW MINIMUM ORDER LEVELS
ACROSS THE MAJORITY OF THE UK MAINLAND.**



INTUMESCENT AND ACOUSTIC MASTIC

A high performance intumescent and acoustic sealant, which in the event of a fire, will swell to provide an inert barrier to smoke and flames.

- Excellent Adhesion To A Wide Range Of Substrates
- Will Not Harden Or Crack With Age
- Dries To A Flexible And Smooth Surface Which Is Readily Paintable
- Easily Applied

Part Number	Description	Volume ml	Quantity Unit/ Box	Ship Wt.Kg Each	Price £ Per Each
JFIREMAS	Intumescent and Acoustic Mastic	310	1/12	0.34	2.56



POLYURETHANE CLEANER

Polyurethane cleaner for cleaning un-cured foam, which attaches to standard foam applicator guns.

- Ideal For Preserving Applicator Guns By Cleaning Out The Nozzle

Part Number	Description	Volume ml	Quantity Unit/ Box	Ship Wt.Kg Each	Price £ Per Each
JF500C	Polyurethane Cleaner	500	1/12	0.50	5.05

APPLICATOR GUNS

A choice of professional and conventional applicator guns for use with gun grade expanding foam.

- Designed To Evenly And Accurately Distribute Foam
- Hand Operated

Part Number	Description	Quantity Unit/ Box	Ship Wt.Kg Each	Price £ Per Each
JFGUNC	Professional	1	0.70	27.60
JFGUNB	Conventional	1	0.60	17.46



PROFESSIONAL



CONVENTIONAL

HEAVY DUTY ANCHORS

MEDIUM DUTY ANCHORS

LIGHT DUTY FIXINGS

PA AND GAS

CHEMICAL ANCHORS

SELF-DRILLING SCREWS

NYLON AND CAVITY FIXINGS

DRILL BITS

SPECIALIST FIXINGS BACKED BY TECHNICAL SUPPORT
www.jcpfixings.co.uk



SLEEVE ANCHORS

Thin walled sleeve anchors suitable for use in concrete, stone, brickwork, perforated bricks, and dense concrete blocks.



- Through Fixing
- Suitable For Fixing Into Solid Brick, Dense Concrete Blocks, And Non-Cracked Concrete
- Torque Controlled Expansion

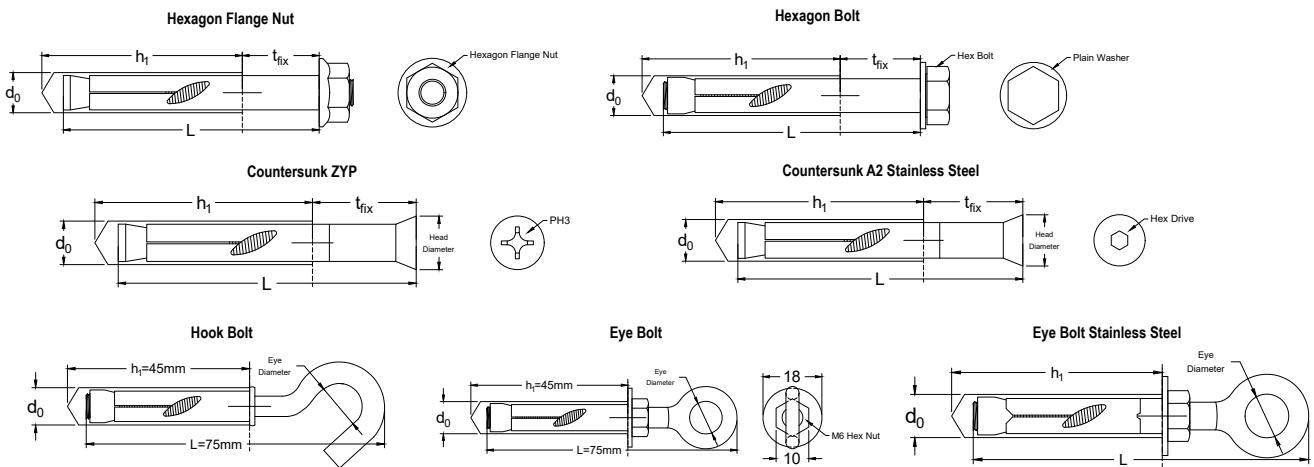

d_0 =Anchor Hole Size L =Length t_{fix} =Minimum Fixture Thickness h_1 =Minimum Hole Depth



HEXAGON FLANGE NUT SLEEVE ANCHORS ZYP

ZINC AND YELLOW PLATED

- Non-Cracked Concrete
- Supplied Pre-Assembled For Rapid Installation
- Minimum 5µm

Part Number	Anchor Hole Size mm d_0	Anchor Length mm L	Max Fixture Thickness mm t_{fix}	Minimum Hole Depth mm h_1	Quantity Per Box	Ship Wt.kg Per 100	Price £ Per 100
SLN08040	8	40	5	35	100	1.60	13.85
SLN08065	8	65	30	40	50	2.42	17.59
SLN08085	8	85	45	40	50	3.14	20.57
SLN10050	10	50	5	45	50	3.26	22.83
SLN10075	10	75	30	45	50	4.64	28.82
SLN10100	10	100	55	45	50	6.04	34.78
SLN10125	10	125	80	45	50	6.40	43.79
SLN12060	12	60	15	50	50	6.52	37.40
SLN12075	12	75	20	60	50	6.84	41.86
SLN12100	12	95	50	60	25	8.90	52.34
SLN12125	12	125	65	60	25	10.95	62.79
SLN16065	16	65	10	60	25	14.60	72.94
SLN16110	16	105	50	65	10	15.80	102.45
SLN16150	16	150	90	65	10	20.10	130.52
SLN20080	20	80	15	70	10	21.60	140.58
SLN20110	20	110	45	70	10	27.60	171.99
SLN20150	20	150	85	70	10	36.80	214.60



HEXAGON BOLT SLEEVE ANCHORS ZYP

ZINC AND YELLOW PLATED

- Non-Cracked Concrete
- Supplied Pre-Assembled For Rapid Installation
- Hex Bolt Gives A Bolt Head Finish
- Minimum 5µm

Part Number	Anchor Hole Size mm d_0	Anchor Length mm L	Max Fixture Thickness mm t_{fx}	Minimum Hole Depth mm h_1	Quantity Per Box	Ship Wt.kg Per 100	Price £ Per 100
SLB08045	8	45	2	45	100	1.85	15.72
SLB08070	8	70	25	45	50	2.54	19.85
SLB08090	8	90	45	45	50	3.22	22.83
SLB10045	10	45	5	45	50	3.26	22.83
SLB10055	10	55	15	45	50	3.56	25.05
SLB10080	10	80	30	50	50	4.84	31.01
SLB10100	10	100	50	50	50	6.00	35.89
SLB12065	12	65	5	65	50	5.92	40.77
SLB12080	12	80	20	65	50	7.20	46.01
SLB12100	12	100	40	65	25	8.80	54.23
SLB12125	12	125	65	65	25	10.80	66.58
SLB16075	16	75	5	65	25	10.75	78.17
SLB16110	16	110	40	65	10	16.10	105.06



COUNTERSUNK HEAD SLEEVE ANCHORS ZYP

ZINC AND YELLOW PLATED

- Non-Cracked Concrete
- Supplied Pre-Assembled For Rapid Installation
- Countersunk Head Gives A Flush Fixture
- Minimum 5µm

Part Number	Anchor Hole Size mm d_0	Anchor Length mm L	Max Fixture Thickness mm t_{fx}	Minimum Hole Depth mm h_1	Head Diameter mm	Quantity Per Box	Ship Wt.kg Per 100	Price £ Per 100
SLC08060	8	60	30	40	14	100	1.92	42.36
SLC08085	8	85	50	40	14	50	2.79	48.58
SLC10075	10	75	40	45	16	50	3.70	60.49
SLC10100	10	100	60	45	16	50	5.44	72.28



HEXAGON FLANGE NUT SLEEVE ANCHORS A4 STAINLESS STEEL

A4-316 STAINLESS STEEL

- Non-Cracked Concrete
- Supplied Pre-Assembled For Rapid Installation
- Suitable For External Use And Marine Environments

Part Number	Anchor Hole Size mm d_0	Anchor Length mm L	Max Fixture Thickness mm t_{fx}	Minimum Hole Depth mm h_1	Quantity Per Box	Ship Wt.kg Per 100	Price £ Per 100
SLSS06060	6	55	25	35	100	1.26	86.00
SLSS08040	8	40	5	40	100	2.31	102.74
SLSS08065	8	65	30	40	50	2.48	138.40
SLSS10050	10	50	10	45	50	3.28	198.41
SLSS10075	10	75	35	45	50	4.62	252.13
SLSS10100	10	95	55	45	50	5.88	312.98
SLSS12060	12	55	10	50	50	5.81	311.67
SLSS12075	12	65	20	60	50	6.88	354.36
SLSS12100	12	95	50	60	25	9.05	444.79



COUNTERSUNK HEAD SLEEVE ANCHORS A2 STAINLESS STEEL

**A2-304
STAINLESS STEEL**

- Non-Cracked Concrete Supplied Pre-Assembled For Rapid Installation
- Countersunk Head Gives Flush Finish Suitable For External Use Hex Drive

Part Number	Anchor Hole Size mm d_0	Anchor Length mm L	Max Fixture Thickness mm t_{fx}	Minimum Hole Depth mm h_1	Head Diameter mm	Quantity Per Box	Ship Wt.kg Per 100	Price £ Per 100
SLC08045SS	8	45	8	50	12	100	1.62	87.90
SLC08060SS	8	60	18	60	12	50	1.93	100.04
SLC10060SS	10	60	9	60	16	50	3.15	138.38
SLC10080SS	10	80	19	80	16	50	4.20	156.64
SLC12070SS	12	70	10	75	20	50	5.83	239.25
SLC12100SS	12	100	30	100	20	25	7.66	305.04

EYE AND HOOK BOLT SLEEVE ANCHORS ZYP

**ZINC AND
YELLOW PLATED**

- Non-Cracked Concrete/Stone/Brickwork/Dense Concrete Blocks Supplied Pre-Assembled For Rapid Installation
- Forged Eye For Improved Strength Minimum 5µm

Part Number	Anchor Hole Size mm d_0	Eye Diameter mm	Minimum Hole Depth mm h_1	Quantity Per Box	Ship Wt.kg Per 100	Price £ Per 100
Hookbolt - SLZH08040	8	11	45	100	2.47	26.90
Forged Eyebolt - SLZE08040F	8	10	45	20	2.12	43.49



Hook Bolt



Eye Bolt

EYE BOLT SLEEVE ANCHORS A2 STAINLESS STEEL

**A2-304
STAINLESS STEEL**

- Non-Cracked Concrete/Stone/Brickwork/Dense Concrete Blocks
- Supplied Pre-Assembled For Rapid Installation Forged Eye For Improved Strength Suitable For External Use

Part Number	Anchor Hole Size mm d_0	Length mm L	Eye Diameter mm	Minimum Hole Depth mm h_1	Quantity Per Box	Ship Wt.kg Per 100	Price £ Per 100
SLZE08045SS	8	78	10	50	50	2.60	305.28
SLZE10060SS	10	90	11	65	50	5.00	454.41





SHIELD ANCHORS

The torque-controlled shield anchor is suitable for use in brick and concrete, with the thick walls of the expanders giving the anchor its exceptional grip.

- Torque Controlled Expansion
- Medium To Heavy Duty Loads
- All Steel Anchor

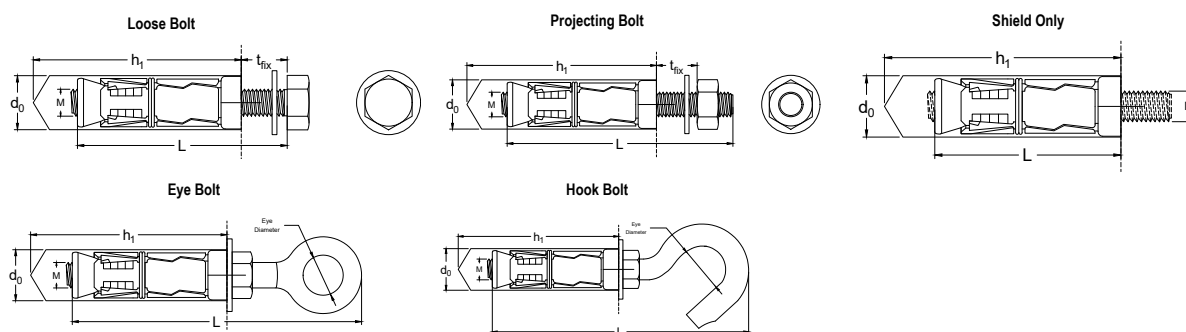

M=Thread Diameter d_0 =Shield Hole Size t_{fix} =Maximum Fixture Thickness L=Length h_1 =Minimum Hole Depth

LOOSE BOLT SHIELD ANCHORS ZYP

ZINC AND YELLOW PLATED

- Non-Cracked Concrete C20/25 To C50/60
- Solid Concrete Blocks
- Solid Brickwork
- Minimum 5µm



Part Number	Thread Diameter M	Shield Hole Size mm d_0	Max Fixture Thickness mm t_{fix}	Length Under Head mm L	Minimum Hole Depth mm h_1	Quantity Per Box	Ship Wt.Kg Per 100	Price £ Per 100
ALB0610	6	12	10	55	50	50	2.36	36.41
ALB0625	6	12	25	70	50	50	2.80	37.63
ALB0640	6	12	40	85	50	50	3.20	44.18
ALB0810	8	14	10	60	55	50	5.78	50.49
ALB0825	8	14	25	75	55	50	6.20	53.89
ALB0840	8	14	40	90	55	50	6.46	57.78
ALB1010	10	16	10	70	65	50	9.44	79.63
ALB1025	10	16	25	85	65	50	9.96	84.48
ALB1050	10	16	50	110	65	50	11.14	90.79
ALB1075	10	16	75	135	65	25	12.90	101.96
ALB1210	12	20	10	85	85	25	17.84	132.06
ALB1225	12	20	25	100	85	25	18.40	136.92
ALB1240	12	20	40	115	85	25	19.16	143.23
ALB1260	12	20	60	135	85	25	21.28	154.40
ALB1615	16	25	15	135	125	10	36.30	317.05
ALB1630	16	25	30	150	125	10	36.60	330.16
ALB1660	16	25	60	180	125	10	42.40	356.86



FREE, NEXT-DAY DELIVERY WITH LOW MINIMUM ORDER LEVELS ACROSS THE MAJORITY OF THE UK MAINLAND.



PROJECTING BOLT SHIELD ANCHORS ZYP

ZINC AND YELLOW PLATED

- Non-Cracked Concrete C20/25 To C50/60
- Solid Concrete Blocks
- Solid Brickwork
- Minimum 5µm

Part Number	Thread Diameter M	Shield Hole Size mm d ₀	Max Fixture Thickness mm t _{fix}	Overall Length mm L	Minimum Hole Depth mm h ₁	Quantity Per Box	Ship Wt.Kg Per 100	Price £ Per 100
APB0610	6	12	10	60	50	50	2.58	37.07
APB0625	6	12	25	75	50	50	2.90	39.45
APB0650	6	12	50	100	50	50	3.34	43.73
APB0815	8	14	15	75	55	50	6.38	54.18
APB0840	8	14	40	100	55	50	7.22	57.04
APB0880	8	14	80	140	55	25	8.56	61.79
APB1010	10	16	10	80	65	50	9.90	78.90
APB1030	10	16	30	100	65	50	10.80	87.93
APB1050	10	16	50	120	65	25	12.00	98.86
APB1070	10	16	70	140	65	25	13.40	106.94
APB1215	12	20	15	100	85	25	19.80	134.04
APB1225	12	20	25	110	85	25	20.40	141.17
APB1250	12	20	50	135	85	10	22.24	155.42
APB1270	12	20	70	155	85	10	23.90	169.68
APB1635	16	25	35	160	125	10	40.40	295.16



SHIELD ONLY SHIELD ANCHORS ZYP

ZINC AND YELLOW PLATED

- Non-Cracked Concrete C20/25 To C50/60
- Solid Concrete Blocks
- Solid Brickwork
- Minimum 5µm

Part Number	Thread Diameter M	Drill Hole Diameter mm d ₀	Max Fixture Thickness mm t _{fix}	Shield Length mm L	Minimum Hole Depth mm h ₁	Quantity Per Box	Ship Wt.Kg Per 100	Price £ Per 100
ASHOM06	6	12	-	45	50	50	1.18	25.10
ASHOM08	8	14	-	50	55	50	3.20	32.04
ASHOM10	10	16	-	60	65	50	4.40	44.18
ASHOM12	12	20	-	75	85	25	9.16	71.86
ASHOM16	16	25	-	110	125	10	17.10	150.51



SHIELD ONLY SHIELD ANCHORS A4 STAINLESS STEEL

A4-316 STAINLESS STEEL

- Non-Cracked Concrete C20/25 To C50/60
- Solid Concrete Blocks
- Solid Brickwork
- Suitable For External Use

Part Number	Thread Diameter M	Drill Hole Diameter mm d ₀	Max Fixture Thickness mm t _{fix}	Shield Length mm L	Minimum Hole Depth mm h ₁	Quantity Per Box	Ship Wt.Kg Per 100	Price £ Per 100
PSM06SS	6	12	-	45	50	25	1.18	273.58
PSM08SS	8	14	-	50	55	25	3.20	366.35
PSM10SS	10	16	-	60	65	25	4.40	485.30
PSM12SS	12	20	-	75	85	10	9.16	642.30



EYE BOLT SHIELD ANCHORS ZYP

ZINC AND YELLOW PLATED

- Non-Cracked Concrete C20/25 To C50/60
- Forged Eye For Improved Strength
- Solid Concrete Blocks
- Minimum 5µm

Part Number	Thread Diameter	Drill Hole Diameter mm d ₀	Eye Diameter mm	Overall Length mm L	Minimum Hole Depth mm h ₁	Quantity Per Box	Ship Wt.Kg Per 100	Price £ Per 100
AEBM06	6	12	10	80	50	25	7.96	76.49
AEBM08	8	14	11	95	55	25	8.52	100.70
AEBM10	10	16	14	115	65	10	15.62	138.20
AEBM12	12	20	16	130	85	10	27.64	211.80



HOOK BOLT SHIELD ANCHORS ZYP

ZINC AND YELLOW PLATED

- ✔ Non-Cracked Concrete C20/25 To C50/60
- ✔ Forged Eye For Improved Strength
- ✔ Solid Concrete Blocks
- ✔ Minimum 5µm

Part Number	Thread Diameter	Drill Hole Diameter mm d_0	Eye Diameter mm	Overall Length mm L	Minimum Hole Depth mm h_1	Quantity Per Box	Ship Wt.Kg Per 100	Price £ Per 100
AHBM06	6	12	8	80	50	25	7.60	76.49
AHBM08	8	14	10	95	55	25	8.20	100.70
AHBM10	10	16	12	115	65	10	14.50	138.20
AHBM12	12	20	16	145	85	10	26.90	211.80



CONCRETE SCREWS

Countersunk head self-tapping screws, suitable for use in concrete, concrete blocks, and masonry.

- ✔ Reaction To Fire Class A1
- ✔ Fast And Secure Installation
- ✔ Good Performance
- ✔ Expansion Free

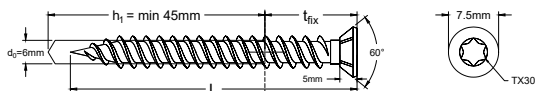

d_0 = Drill Diameter L = Screw Length t_{fix} = Maximum Fixture Thickness h_1 = Minimum Hole Depth



COUNTERSUNK HEAD CONCRETE SCREWS ZYP

ZINC AND YELLOW PLATED

- ✔ Complete With White Cover Cap
- ✔ T30 Drive Bit Included
- ✔ Locking Ribs Under Head
- ✔ Undercutting Action
- ✔ Minimum 5µm

Part Number	Drill Diameter mm d_0	Screw Length mm L	Max Fixture Thickness mm t_{fix}	Minimum Hole Depth mm h_1	Quantity Per Box	Ship Wt.Kg Per 100	Price £ Per 1000
CS75040	6	40	-	45	100	1.00	69.15
CS75060	6	60	20	45	100	1.45	95.86
CS75080	6	80	40	45	100	1.72	123.14
CS75100	6	100	60	45	100	2.53	151.96
CS75120	6	120	80	45	100	2.93	182.13
CS75150	6	150	110	45	100	3.16	232.38
CS75180	6	180	140	45	100	3.78	286.78



COUNTERSUNK HEAD CONCRETE SCREWS NO COVER CAPS ZYP

ZINC AND YELLOW PLATED

- ✓ Locking Ribs Under Head
- ✓ Undercutting Action
- ✓ Minimum 5µm

Part Number	Drill Diameter mm d_0	Screw Length mm L	Max Fixture Thickness mm t_{fix}	Minimum Hole Depth mm h_1	Quantity Per Box	Ship Wt.Kg Per 100	Price £ Per 1000
CS75040A	6	40	-	45	100	1.00	54.69
CS75060A	6	60	20	45	100	1.45	80.72
CS75080A	6	80	40	45	100	1.72	106.82
CS75100A	6	100	60	45	100	2.53	132.85
CS75120A	6	120	80	45	100	2.93	158.88
CS75150A	6	150	110	45	100	3.16	207.93
CS75180A	6	180	140	45	100	3.78	248.89

CONCRETE SCREW COVER CAPS

- ✓ Simply Pushes Into The Head Of The Screw
- ✓ Available In White Or Brown

Part Number	Colour	Quantity Per Box	Ship Wt.Kg Per 100	Price £ Per 100
CSCAPWH	White	100	0.01	1.25
CSCAPBR	Brown	100	0.01	1.25



Technical data sheets can be found on the JCP website for products within the range.

The data sheets provide detailed information on the following; where applicable.

- ✓ Product information
- ✓ Load and range data
- ✓ Performance data
- ✓ Installation instructions
- ✓ Features
- ✓ Base material guidance
- ✓ Related products

www.jcpfixings.co.uk



FOR TECHNICAL ADVICE CALL OUR TECHNICAL HELPLINE ON 020 8943 1800



SELF-DRILLING SCREWS BZP

Self-drilling, self-tapping screws for fixing various materials to steel.

- High-Clamping Action
- Gash Points For Fixing Steel To Wood
- Range With EDPM Washers To Provide Waterproof Seal



LIGHT SECTION



HEAVY SECTION

METALFIX SELF-DRILLING SCREWS BZP

- For Fixing Steel To Steel
- Hexagon Head
- DIN 7504K
- C1022 Steel Case Hardened
- Minimum 8µm

BRIGHT ZINC PLATED

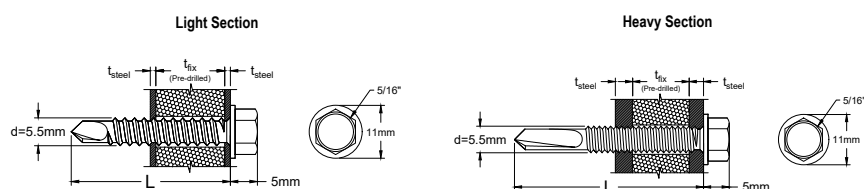

d=Thread Diameter L=Length t_{steel} =Steel Thickness t_{fix} =Maximum Fixture Thickness

Part Number	Thread Diameter mm d	Length mm L	Point Type	Steel Thickness t_{steel}	Max Fixture Thickness mm t_{fix}	Washer Diameter mm	Quantity Per Box	Ship Wt.Kg Per 100	Price £ Per 100
LIGHT SECTION									
MFL55019	5.5	19	3	1.2-3.0	4	-	100	0.38	4.70
MFL55025	5.5	25	3	1.2-3.0	10	-	100	0.56	5.11
MFL55032	5.5	32	3	1.2-3.0	17	-	100	0.65	6.00
MFL55038	5.5	38	3	1.2-3.0	23	-	100	0.74	6.66
MFL55050	5.5	50	3	1.2-3.0	35	-	100	0.90	8.12
HEAVY SECTION									
MFH55022	5.5	22	4	3.0-6.0	5	-	100	0.52	5.79
MFH55032	5.5	32	5	4.0-12.5	5	-	100	0.65	7.82
MFH55040	5.5	40	5	4.0-12.5	13	-	100	0.76	9.35
MFH55050	5.5	50	5	4.0-12.5	23	-	100	0.90	10.55
MFH55060	5.5	60	5	4.0-12.5	33	-	100	1.04	12.41
MFH55070	5.5	70	5	4.0-12.5	43	-	100	1.18	14.05
MFH55080	5.5	80	5	4.0-12.5	53	-	100	1.32	15.90



LIGHT SECTION



HEAVY SECTION

METALFIX SELF-DRILLING SCREWS WITH 16MM WASHER BZP

BRIGHT ZINC PLATED

- For Fixing Steel To Steel
- Supplied With 16mm Washer
- EPDM Washer To Prevent Water Ingress
- For General Purpose Applications
- Hexagon Head
- DIN 7504K
- C1022 Steel Case Hardened
- Minimum 8µm

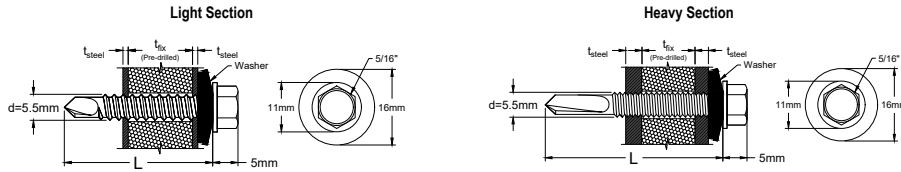

d=Thread Diameter L=Length t_{steel} =Steel Thickness t_{fix} =Maximum Fixture Thickness

Part Number	Thread Diameter mm d	Length mm L	Point Type	Steel Thickness t_{steel}	Max Fixture Thickness mm t_{fix}	Washer Diameter mm	Quantity Per Box	Ship Wt.Kg Per 100	Price £ Per 100
LIGHT SECTION									
MFL55025W16	5.5	25	3	1.2-3.0	7	16	100	0.51	7.57
MFL55032W16	5.5	32	3	1.2-3.0	14	16	100	0.59	8.33
MFL55038W16	5.5	38	3	1.2-3.0	20	16	100	0.67	8.99
MFL55043W16	5.5	43	3	1.2-3.0	25	16	100	0.89	9.90
MFL55050W16	5.5	50	3	1.2-3.0	32	16	100	0.81	10.52
MFL55057W16	5.5	57	3	1.2-3.0	39	16	100	0.81	11.65
MFL55070W16	5.5	70	3	1.2-3.0	52	16	100	1.21	13.17
MFL55075W16	5.5	75	3	1.2-3.0	57	16	100	1.05	13.61
HEAVY SECTION									
MFH55022W16	5.5	22	4	3.0-6.0	2	16	100	0.47	8.30
MFH55032W16	5.5	32	5	4.0-12.5	2	16	100	0.59	10.01
MFH55040W16	5.5	40	5	4.0-12.5	10	16	100	0.69	11.72
MFH55050W16	5.5	50	5	4.0-12.5	20	16	100	0.81	12.92
MFH55060W16	5.5	60	5	4.0-12.5	30	16	100	0.93	14.70
MFH55070W16	5.5	70	5	4.0-12.5	40	16	100	1.07	16.19
MFH55080W16	5.5	80	5	4.0-12.5	50	16	100	1.18	17.98
MFH55100W16	5.5	100	5	4.0-12.5	70	16	100	1.43	22.89
MFH55120W16	5.5	120	5	4.0-12.5	90	16	100	1.68	26.86

METALFIX SELF-DRILLING SCREWS WITH 19MM WASHER BZP

BRIGHT ZINC PLATED

- For Fixing Steel To Steel
- Supplied With 19mm Washer
- EPDM Washer To Prevent Water Ingress
- For Roofing Applications
- Hexagon Head
- DIN 7504K
- C1022 Steel Case Hardened
- Minimum 8µm

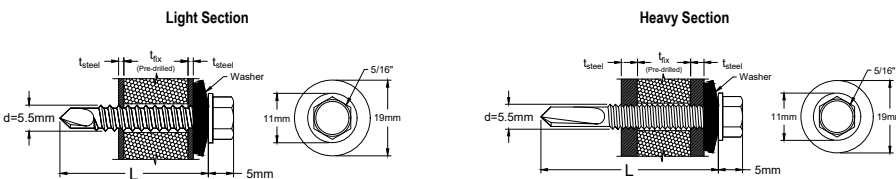

d=Thread Diameter L=Length t_{steel} =Steel Thickness t_{fix} =Maximum Fixture Thickness

Part Number	Thread Diameter mm d	Length mm L	Point Type	Steel Thickness t_{steel}	Max Fixture Thickness mm t_{fix}	Washer Diameter mm	Quantity Per Box	Ship Wt.Kg Per 100	Price £ Per 100
LIGHT SECTION									
MFL55025W19	5.5	25	3	1.2-3.0	7	19	100	0.51	8.19
MFL55032W19	5.5	32	3	1.2-3.0	14	19	100	0.59	9.21
MFL55038W19	5.5	38	3	1.2-3.0	20	19	100	0.67	10.34
MFL55050W19	5.5	50	3	1.2-3.0	32	19	100	0.81	12.01
MFL55075W19	5.5	75	3	1.2-3.0	57	19	100	1.05	14.92
HEAVY SECTION									
MFH55022W19	5.5	22	4	3.0-6.0	2	19	100	0.47	9.10
MFH55032W19	5.5	32	5	4.0-12.5	2	19	100	0.59	10.92
MFH55040W19	5.5	40	5	4.0-12.5	10	19	100	0.69	12.45
MFH55050W19	5.5	50	5	4.0-12.5	20	19	100	0.81	13.83
MFH55060W19	5.5	60	5	4.0-12.5	30	19	100	0.93	15.90
MFH55070W19	5.5	70	5	4.0-12.5	40	19	100	1.07	16.92
MFH55080W19	5.5	80	5	4.0-12.5	50	19	100	1.18	19.25
MFH55100W19	5.5	100	5	4.0-12.5	70	19	100	1.43	24.16
MFH55120W19	5.5	120	5	4.0-12.5	90	19	100	1.68	29.08



GENERAL PURPOSE METALFIX SELF-DRILLING SCREWS BZP

BRIGHT ZINC PLATED

- For Fixing Steel To Steel
- Hexagon Head
- DIN 7504K
- C1022 Steel Case Hardened
- Minimum 8µm

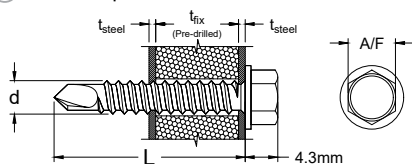

d=Thread Diameter L=Length t_{steel} =Steel Thickness t_{fix} =Maximum Fixture Thickness

Part Number	Thread Diameter mm d	Length mm L	Point Type	Steel Thickness t_{steel}	Max Fixture Thickness mm t_{fix}	Washer Diameter mm	Across Flats "	Quantity Per Box	Ship Wt.Kg Per 100	Price £ Per 100
GP42013	4.2	13	2	1.2-2.5	5	-	1/4 (7mm)	200	0.19	2.39
GP42016	4.2	16	2	1.2-2.5	8	-	1/4 (7mm)	200	0.21	2.52
GP42019	4.2	19	2	1.2-2.5	11	-	1/4 (7mm)	200	0.22	2.77
GP42025	4.2	25	2	1.2-2.5	17	-	1/4 (7mm)	200	0.29	3.17
GP48016	4.8	16	3	1.2-3.0	2	-	5/16 (8mm)	100	0.29	3.43
GP48019	4.8	19	3	1.2-3.0	5	-	5/16 (8mm)	100	0.30	3.75
GP48025	4.8	25	3	1.2-3.0	11	-	5/16 (8mm)	100	0.35	4.18



METALFIX LOOSE WASHERS BZP

BRIGHT ZINC PLATED

- For Use With Self-Drilling Screws
- 1mm Steel With A 2mm Bonded EPDM Backing
- Creates A Watertight Seal

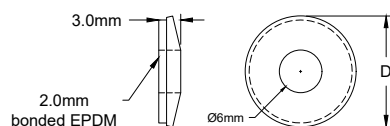

D=Washer Diameter

Part Number	Thread Diameter mm	Washer Diameter mm D	Quantity Per Box	Ship Wt.Kg Per 100	Price £ Per 100
MFW16	6	16	100	0.15	3.93
MFW19	6	19	100	0.18	5.05



POZI PAN HEAD METALFIX SELF-DRILLING SCREWS BZP

BRIGHT ZINC PLATED

- For Fixing Steel To Steel
- DIN 7504N
- C1022 Steel Case Hardened
- Minimum 8µm

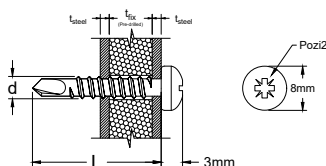

d=Thread Diameter L=Length t_{steel} =Steel Thickness t_{fix} =Maximum Fixture Thickness

Part Number	Thread Diameter mm d	Length mm L	Point Type	Steel Thickness t_{steel}	Max Fixture Thickness mm t_{fix}	Washer Diameter mm	Quantity Per Box	Ship Wt.Kg Per 100	Price £ Per 100
PH35095	3.5	9.5	2	1.2-2.5	1	-	200	0.08	1.73
PH35013	3.5	13	2	1.2-2.5	5	-	200	0.10	1.87
PH35019	3.5	19	2	1.2-2.5	11	-	200	0.12	2.16
PH42013	4.2	13	2	1.2-2.5	5	-	200	0.15	2.40
PH42016	4.2	16	2	1.2-2.5	8	-	200	0.17	2.60
PH42019	4.2	19	2	1.2-2.5	11	-	200	0.19	2.82
PH42025	4.2	25	2	1.2-2.5	17	-	200	0.23	3.26
PH48013	4.8	13	3	1.2-3.0	2	-	200	0.21	3.10
PH48019	4.8	19	3	1.2-3.0	5	-	200	0.26	3.62
PH48025	4.8	25	3	1.2-3.0	11	-	200	0.32	4.31



WOODFIX SELF-DRILLING SCREWS BZP

BRIGHT ZINC PLATED

- For Fixing Timber To Steel
- Countersunk Head Gives Flush Finish
- DIN 7504P
- Wings Drill A Clearance Hole To Prevent The Timber Jacking
- C1022 Steel Case Hardened
- Minimum 8µm

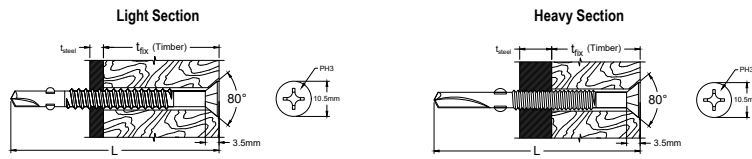

L=Length t_{steel} =Steel Thickness t_{fix} =Maximum Fixture Thickness

LIGHT SECTION

Part Number	Thread Diameter mm	Length mm L	Point Type	Steel Thickness t_{steel}	Max Fixture Thickness mm t_{fix}	Washer Diameter mm	Quantity Per Box	Ship Wt.Kg Per 100	Price £ Per 100
LIGHT SECTION									
WFL55040	5.5	40	3	1.2-3.0	22	-	100	0.71	7.14
WFL55050	5.5	50	3	1.2-3.0	32	-	100	0.85	8.31
WFL55060	5.5	60	3	1.2-3.0	42	-	100	1.00	9.71
WFL55080	5.5	80	3	1.2-3.0	62	-	100	1.28	13.71
WFL55100	5.5	100	3	1.2-3.0	82	-	100	1.56	17.28
WFL55110	5.5	110	3	1.2-3.0	92	-	100	1.70	21.11
WFL55120	5.5	120	3	1.2-3.0	112	-	100	1.86	24.55
HEAVY SECTION									
WFH55050	5.5	50	5	4.0-12.5	23	-	100	0.85	11.00
WFH55060	5.5	60	5	4.0-12.5	33	-	100	1.00	12.67
WFH55070	5.5	70	5	4.0-12.5	43	-	100	1.14	14.27
WFH55085	5.5	85	5	4.0-12.5	58	-	100	1.35	17.91
WFH55109	5.5	109	5	4.0-12.5	82	-	100	1.69	23.23
WFH55120	5.5	120	5	4.0-12.5	92	-	100	1.86	30.36

HEAVY SECTION



WOODFIX DRIVE BIT

BRIGHT ZINC PLATED

- PH3 Drive Bit
- Heat Treated For Longer Life

Part Number	Quantity Per Box	Ship Wt.Kg Per 100	Price £ Per 100
WFPH3	10	0.30	31.53

METALFIX GASH POINT SELF-DRILLING SCREWS BZP

BRIGHT ZINC PLATED

- For Fixing Steel To Timber
- Supplied With 16mm Or 19mm Washer
- EPDM Washer To Prevent Water Ingress
- Gash Point For Quick Penetration
- Hexagon Head
- Sharp Threads Ensure A Low Torque And Strong Fixing
- Minimum 8µm

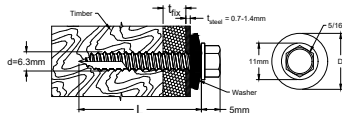

d=Thread Diameter L=Length t_{steel} =Steel Thickness t_{fix} =Maximum Fixture Thickness

Part Number	Thread Diameter mm d	Length mm L	Steel Thickness t_{steel}	Max Fixture Thickness mm t_{fix}	Washer Diameter mm D	Quantity Per Box	Ship Wt.Kg Per 100	Price £ Per 100
GP6303216W	6.3	32	0.7-1.4	1	16	100	0.84	10.44
GP6304516W	6.3	45	0.7-1.4	5	16	100	1.05	12.53
GP6306016W	6.3	60	0.7-1.4	15	16	100	1.25	15.46
GP6308016W	6.3	80	0.7-1.4	35	16	100	1.50	19.16
GP6310016W	6.3	100	0.7-1.4	55	16	100	1.76	22.13
GP6312516W	6.3	125	0.7-1.4	80	16	100	2.02	29.74
GP6302519W	6.3	25	0.7-1.4	1	19	100	0.77	10.32
GP6303219W	6.3	32	0.7-1.4	1	19	100	0.84	11.50
GP6304519W	6.3	45	0.7-1.4	5	19	100	1.05	13.33
GP6306019W	6.3	60	0.7-1.4	15	19	100	1.34	17.02
GP6308019W	6.3	80	0.7-1.4	35	19	100	1.67	21.02
GP6310019W	6.3	100	0.7-1.4	55	19	100	1.99	25.63
GP6312519W	6.3	125	0.7-1.4	80	19	100	2.40	32.87
GP6315019W	6.3	150	0.7-1.4	105	19	100	2.81	41.09



METALFIX STITCHING SCREWS BZP

BRIGHT ZINC PLATED

- ✔ For Joining Two Thin Sheets Of Steel
- ✔ Supplied With 16mm Or 19mm Washer
- ✔ EPDM Washer To Prevent Water Ingress
- ✔ Hexagon Head
- ✔ DIN 7504K
- ✔ Larger Diameter To Give Better Grip In Steel
- ✔ Minimum 8µm

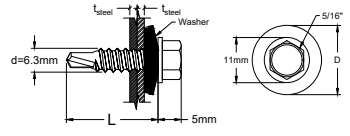

d=Thread Diameter L=Length t_{steel} =Steel Thickness D=Washer Diameter

Part Number	Thread Diameter mm d	Length mm L	Point Type	Steel Thickness t_{steel}	Washer Diameter mm D	Quantity Per Box	Ship Wt.Kg Per 100	Price £ Per 100
SS63022W16	6.3	22	1	2 x 0.9	16	100	0.70	8.25
SS63025W16	6.3	25	1	2 x 1.2	16	100	0.70	8.39
SS63022W19	6.3	22	1	2 x 0.9	19	100	0.80	9.22
SS63025W19	6.3	25	1	2 x 1.2	19	100	0.80	9.36

Maximum Fixture Thickness allows for Maximum Steel Thickness



METALFIX HIGH THREAD SELF-DRILLING SCREWS BZP

BRIGHT ZINC PLATED

- ✔ For Fixing Composite Panels To Steel
- ✔ Supplied With 19mm Washer
- ✔ EPDM Washer To Prevent Water Ingress
- ✔ Hexagon Head
- ✔ Minimum 8µm

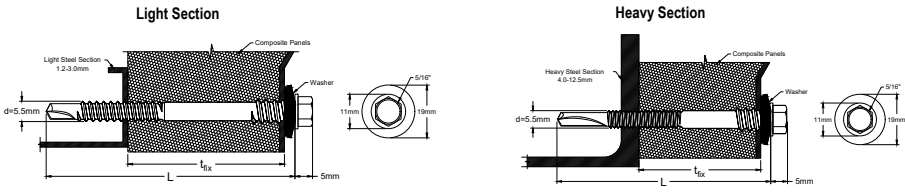

d=Thread Diameter L=Length t_{fix} =Insulation Thickness

LIGHT SECTION

HEAVY SECTION

Part Number	Thread Diameter mm d	Length mm L	Point Type	Steel Thickness	Insulation Thickness mm t_{fix}	Washer Diameter mm	Quantity Per Box	Ship Wt.Kg Per 100	Price £ Per 100
LIGHT SECTION									
HT55065	5.5	65	3	1.2-3.0	30-45	19	100	1.22	18.06
HT55070	5.5	70	3	1.2-3.0	35-50	19	100	1.30	18.60
HT55075	5.5	75	3	1.2-3.0	40-55	19	100	1.34	19.27
HT55085	5.5	85	3	1.2-3.0	40-60	19	100	1.46	22.13
HT55100	5.5	100	3	1.2-3.0	45-75	19	100	1.96	24.10
HT55125	5.5	125	3	1.2-3.0	75-100	19	100	2.46	32.42
HT55150	5.5	150	3	1.2-3.0	90-120	19	100	2.90	36.49
HEAVY SECTION									
HTH55075	5.5	75	5	4.0-12.5	30-45	19	100	1.43	21.75
HTH55105	5.5	105	5	4.0-12.5	50-64	19	100	1.82	29.52
HTH55130	5.5	130	5	4.0-12.5	60-95	19	100	2.18	36.07



WOODFIX HIGH THREAD SELF-DRILLING SCREWS FOR TIMBER BZP **NEW**

**BRIGHT ZINC
PLATED**

- ✔ For Fixing Composite Panels To Wood
- ✔ DIN 7504P
- ✔ C1022 Steel Case Hardened
- ✔ Minimum 8µm

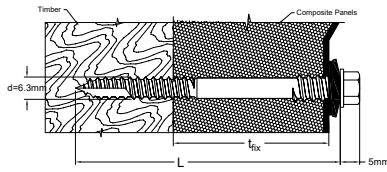

d=Thread Diameter L=Length t_{fix} =Maximum Fixture Thickness

Part Number	Thread Diameter mm d	Length mm L	Point Type	Thread Length mm L	Max Fixture Thickness mm t_{fix}	Washer Diameter mm	Quantity Per Box	Ship Wt.Kg Per 100	Price £ Per 100
HTW63060	6.3	60	-	40	10	19	100	1.29	18.10
HTW63080	6.3	80	-	40	30	19	100	1.61	21.50
HTW63100	6.3	100	-	50	50	19	100	1.91	27.50
HTW63125	6.3	125	-	50	75	19	100	2.32	35.50
HTW63150	6.3	150	-	50	100	19	100	2.76	45.25



LOW PROFILE METALFIX SELF-DRILLING SCREWS BZP

**BRIGHT ZINC
PLATED**

- ✔ For Fixing Steel To Steel
- ✔ Large Head For Increased Clamping
- ✔ Coarse Thread For Improved Grip And Pull Out
- ✔ Minimum 8µm

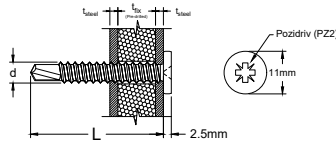

LIGHT SECTION

d=Thread Diameter L=Length t_{steel} =Steel Thickness t_{fix} =Maximum Fixture Thickness

Part Number	Thread Diameter mm d	Length mm L	Point Type	Steel Thickness t_{steel}	Max Fixture Thickness mm t_{fix}	Head Diameter mm	Quantity Per Box	Ship Wt.Kg Per 100	Price £ Per 100
LIGHT SECTION									
LLP48016	4.8	16	3	1.2-2.5	8	10	200	0.27	8.56
LLP48025	4.8	25	3	1.2-2.5	17	10	200	0.32	9.57
LLP48030	4.8	30	3	1.2-2.5	22	10	200	0.35	10.08
LLP48040	4.8	40	3	1.2-2.5	32	10	100	0.38	11.46
HEAVY SECTION									
HLP55020	5.5	20	3	1.2-3.5	5	10	200	0.35	9.44
HLP55040	5.5	40	3	1.2-3.5	25	10	100	0.67	12.76

HEAVY SECTION



WAFER HEAD SELF-DRILLING SCREWS BZP **NEW LINES ADDED**

BRIGHT ZINC PLATED

- For Fixing Steel To Steel
- Low Profile Wafer Head For Larger Bearing Surface
- Sharp Point Designed To Penetrate Effectively
- Fine Thread Ensures Strong Connection

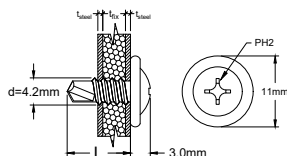

d=Thread Diameter L=Length t_{steel} =Steel Thickness t_{fix} =Maximum Fixture Thickness

Part Number	Thread Diameter mm d	Length mm L	Point Type	Steel Thickness t_{steel}	Max Fixture Thickness mm t_{fix}	Head Diameter mm	Quantity Per Box	Ship Wt.Kg Per 100	Price £ Per 100
WH4213	4.2	13	2	1.2-2.5	2	11	200	0.25	2.52
WH4816	4.8	16	3	1.2-3.0	3	11	100	0.27	3.95
WH5520	5.5	20	3	1.2-3.0	5	12	100	0.44	6.15
WH5540	5.5	40	3	1.2-3.0	24	12	100	0.67	8.95



METALFIX MAGNETIC SOCKETS

- Magnetic To Hold Screw in Place

Part Number	Size "	Quantity Per Box	Ship Wt.Kg Per 100	Price £ Per 100
MF516	5/16	1	3.00	221.00



FIBRE CEMENT SCREWS BZP

BRIGHT ZINC PLATED

- For Fixing Fibre Cement Profiles To Steel
- Supplied With Washer For Watertight Fixing
- Reamer On Shank Makes A Clearance To Allow Sheet Expansion And Contraction
- Minimum 8µm

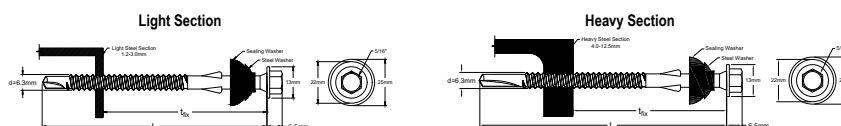

d=Thread Diameter L=Length t_{fix} =Maximum Fixture Thickness

LIGHT SECTION

Part Number	Thread Diameter mm d	Length mm L	Point Type	Steel Thickness	Max Fixture Thickness mm t_{fix}	Washer Diameter mm	Quantity Per Box	Ship Wt.Kg Per 100	Price £ Per 100
LIGHT SECTION									
FCL63110	6.3	110	3	1.2-3.0	75	22/25	50	2.23	45.06
FCL63125	6.3	125	3	1.2-3.0	95	22/25	50	2.78	49.76
FCL63155	6.3	155	3	1.2-3.0	125	22/25	50	3.27	64.29
FCL63175	6.3	175	3	1.2-3.0	145	22/25	50	3.58	73.01
FCL63195	6.3	195	3	1.2-3.0	165	22/25	50	3.92	84.31
FCL63230	6.3	230	3	1.2-3.0	200	22/25	50	4.59	118.39
HEAVY SECTION									
FCH63110	6.3	110	5	4.0-12.5	75	22/25	50	2.48	47.96
FCH63130	6.3	130	5	4.0-12.5	95	22/25	50	2.81	51.16
FCH63150	6.3	150	5	4.0-12.5	120	22/25	50	3.13	62.89
FCH63180	6.3	180	5	4.0-12.5	145	22/25	50	3.62	80.00
FCH63200	6.3	200	5	4.0-12.5	165	22/25	50	3.94	100.52
FCH63235	6.3	235	5	4.0-12.5	200	22/25	50	4.70	132.74

HEAVY SECTION



FIBRE CEMENT SCREWS FOR TIMBER WITH A2 STAINLESS STEEL AND BLACK NEOPRENE WASHER **NEW**

BRIGHT ZINC PLATED

- ✓ For Fixing Fibre Cement Profiles To Wood
- ✓ Supplied With Washer For Watertight Fixing
- ✓ Reamer On Shank Makes A Clearance To Allow Sheet Expansion And Contraction
- ✓ Minimum 8µm

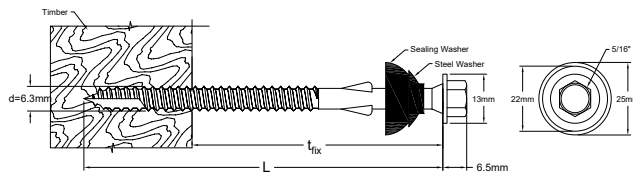

d=Thread Diameter L=Length t_{fix} =Maximum Fixture Thickness

Part Number	Thread Diameter mm d	Length mm L	Thread Length mm	Max Fixture Thickness mm t_{fx}	Washer Diameter mm	Quantity Per Box	Ship Wt.Kg Per 100	Price £ Per 100
FCW63110	6.3	110	65	60	22/25	50	2.23	44.70
FCW63130	6.3	130	65	80	22/25	50	2.78	49.65
FCW63150	6.3	150	90	100	22/25	50	3.27	59.50

SELF-DRILLING SCREWS STAINLESS STEEL

Self-drilling, self-tapping screws for fixing various materials to steel.

- ✓ High-Clamping Action
- ✓ Gash Points For Fixing Steel To Wood
- ✓ Range With EDPM Washers To Provide Waterproof Seal
- ✓ Stainless Steel Provides Excellent Corrosion Resistance



METALFIX BI-METAL A2 STAINLESS STEEL

A2-304 STAINLESS STEEL

- ✓ For Fixing Steel To Steel
- ✓ Hexagon Head

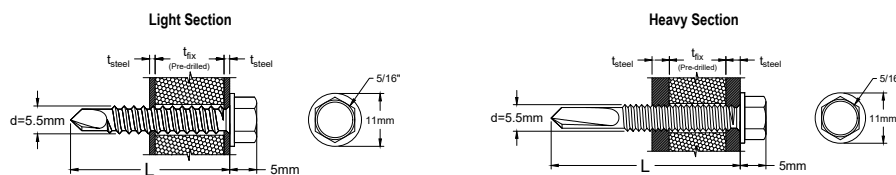

d=Thread Diameter L=Length t_{steel} =Steel Thickness t_{fix} =Maximum Fixture Thickness

Part Number	Thread Diameter mm d	Length mm L	Point Type	Steel Thickness t_{steel}	Max Fixture Thickness mm t_{fx}	Washer Diameter mm	Quantity Per Box	Ship Wt.Kg Per 100	Price £ Per 100
LIGHT SECTION									
MFL55022SS	5.5	22	3	1.3-3.0	2	-	100	0.54	34.05
MFL55025SS	5.5	25	3	1.3-3.0	7	-	100	0.56	34.22
MFL55032SS	5.5	32	3	1.3-3.0	14	-	100	0.65	37.95
MFL55038SS	5.5	38	3	1.3-3.0	20	-	100	0.74	41.03
MFL55050SS	5.5	50	3	1.3-3.0	32	-	100	0.90	46.23
HEAVY SECTION									
MFH55038SS	5.5	38	5	4.0-12.5	8	-	100	0.76	52.11
MFH55050SS	5.5	50	5	4.0-12.5	20	-	100	0.90	58.19



METALFIX LOOSE WASHERS A2 STAINLESS STEEL

A2-304
STAINLESS STEEL

- ✓ For Use With Self-Drilling Screws
- ✓ 1mm A2 Stainless Steel With A 2mm Bonded EPDM Backing
- ✓ Creates A Watertight Seal

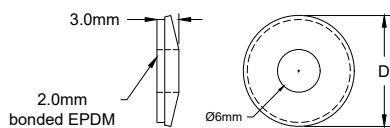

D=Washer Diameter

Part Number	Hole Diameter mm	Washer Diameter mm D	Quantity Per Box	Ship Wt.Kg Per 100	Price £ Per 100
MFW16SS	6	16	100	0.15	6.03
MFW19SS	6	19	100	0.18	7.17



METALFIX WITH WASHER BI-METAL A2 STAINLESS STEEL

A2-304
STAINLESS STEEL

- ✓ For Fixing Steel To Steel
- ✓ Supplied With 16mm Washer
- ✓ EPDM Washer To Prevent Water Ingress
- ✓ For General Purpose Applications
- ✓ Hexagon Head

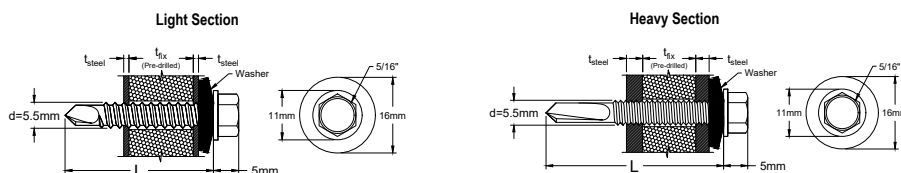

LIGHT SECTION

d=Thread Diameter L=Length t_{steel} =Steel Thickness t_{fix} =Maximum Fixture Thickness



HEAVY SECTION

Part Number	Thread Diameter mm d	Length mm L	Point Type	Steel Thickness t_{steel}	Max Fixture Thickness mm t_{fix}	Washer Diameter mm	Quantity Per Box	Ship Wt.Kg Per 100	Price £ Per 100
LIGHT SECTION									
MFL55022SSW16	5.5	22	3	1.2-3.0	2	16	100	0.49	40.54
MFL55025SSW16	5.5	25	3	1.2-3.0	7	16	100	0.51	40.55
MFL55032SSW16	5.5	32	3	1.2-3.0	14	16	100	0.59	44.23
MFL55038SSW16	5.5	38	3	1.2-3.0	20	16	100	0.67	48.06
MFL55050SSW16	5.5	50	3	1.2-3.0	32	16	100	0.81	53.25
HEAVY SECTION									
MFH55038SSW16	5.5	38	5	4.0-12.5	8	16	100	0.69	58.20
MFH55050SSW16	5.5	50	5	4.0-12.5	20	16	100	0.81	66.86



WOODFIX SELF-DRILLING SCREWS BI-METAL A2 STAINLESS STEEL

A2-304
STAINLESS STEEL

- ✓ For Fixing Timber To Steel
- ✓ Countersunk Head For Flush Finish
- ✓ Wings Drill A Clearance Hole To Prevent The Timber Jacking

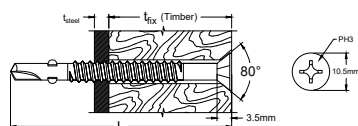

L=Length t_{steel} =Steel Thickness t_{fix} =Maximum Fixture Thickness

Part Number	Thread Diameter mm d	Length mm L	Point Type	Steel Thickness t_{steel}	Max Fixture Thickness mm t_{fix}	Quantity Per Box	Ship Wt.Kg Per 100	Price £ Per 100
WFL55040SS	5.5	40	3	1.2-3.0	22	100	0.71	49.22
WFL55050SS	5.5	50	3	1.2-3.0	32	100	0.85	52.53
WFL55060SS	5.5	60	3	1.2-3.0	42	100	1.00	57.30
WFL55080SS	5.5	80	3	1.2-3.0	62	100	1.28	65.47



METALFIX STITCHING SCREWS A2 STAINLESS STEEL

**A2-304
STAINLESS STEEL**

- ✔ For Joining Two Thin Sheets of Steel
- ✔ Supplied With 16mm Washer
- ✔ EPDM Washer To Prevent Water Ingress
- ✔ Hexagon Head
- ✔ Larger Diameter To Give Better Grip In Steel

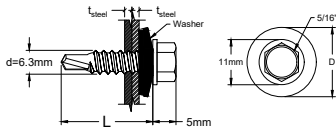

d=Thread Diameter L=Length t_{steel} =Steel Thickness D=Washer Diameter

Part Number	Thread Diameter mm d	Length mm L	Point Type	Steel Thickness t_{steel}	Max Fixture Thickness mm	Washer Diameter mm D	Quantity Per Box	Ship Wt.Kg Per 100	Price £ Per 100
SS63025SSW16	6.3	25	1	2 x 0.9	16	16	100	0.70	46.60
SS63035SSW16	6.3	35	1	2 x 1.2	16	16	100	0.70	53.45



COVER CAPS

A range of coloured cover caps to suit hexagon head self-drilling screws.

- ✔ Colour Coded To British Standard
- ✔ Push Fit Over 16mm And 19mm Washers
- ✔ Provide An Additional Weather Seal

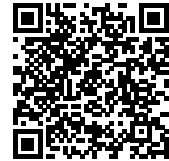

COLOURED COVER CAPS

Part Number 16mm Washer	Part Number 19mm Washer	Colour	Quantity Per Bag	Ship Wt.Kg Per 100	Price £ Per 100
MFC16AN	MFC19AN	Anthracite (18A14)	1000	0.82	4.50
MFC16BL	MFC19BL	Black (00E53)	1000	0.82	4.50
MFC16GG	MFC19GG	Goosewing Light Grey (10A05)	1000	0.82	4.50
MFC16JG	MFC19JG	Juniper Green (12B29)	1000	0.82	4.50
MFC16MG	MFC19MG	Merlin Dark Grey (18B25)	1000	0.82	4.50
MFC16MO	MFC19MO	Moorland Green (12B21)	1000	0.82	4.50
MFC16MU	MFC19MU	Mushroom (10B19)	1000	0.82	4.50
MFC16OB	MFC19OB	Ocean Blue (18C39)	1000	0.82	4.50
MFC16OG	MFC19OG	Olive Green (12B27)	1000	0.82	4.50
MFC16PR	MFC19PR	Poppy Red (04E53)	1000	0.82	4.50
MFC16SB	MFC19SB	Slate Blue (18B29)	1000	0.82	4.50
MFC16SG	MFC19SG	Slate Grey (18B27)	1000	0.82	4.50
MFC16VB	MFC19VB	Vandyke Brown (08B29)	1000	0.82	4.50
MFC16WH	MFC19WH	White (00E55)	1000	0.82	4.50





INTERNAL THREADED SELF-DRILLING SCREWS

Internally threaded sockets for hanging vertically threaded rods, and internal threaded screws for fixing horizontally into purlins and steel.

- ☑ One Piece Internally Threaded Fastening System
- ☑ All Steel



METALFIX VERTICAL HANGERS

- ☑ For Hanging Threaded Rods From Purlins, Light Steel Or Heavy Steel
- ☑ Fast Overhead Installation With A Screwgun
- ☑ Supplied Complete With Back-Nut For Additional Security

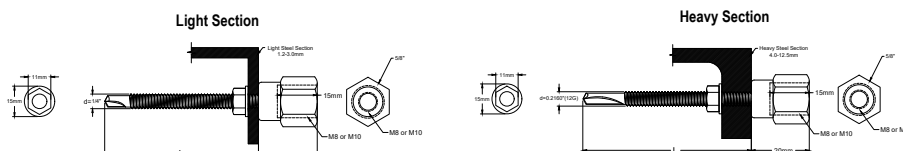

LIGHT SECTION

d=Thread Diameter L=Length



HEAVY SECTION

Part Number	Thread Diameter " d	Length mm L	Point Type	Steel Thickness	Internal Thread Diameter M	Across Flats " A/F	Quantity Per Box	Ship Wt.Kg Per 100	Price £ Per 100
LIGHT SECTION									
MFL55M0825V	1/4	25	3	1.2-3.0	8	5/8	100	3.55	73.29
MFL55M0838V	1/4	38	3	1.2-3.0	8	5/8	100	3.40	75.37
MFL55M1025V	1/4	25	3	1.2-3.0	10	5/8	100	3.70	71.46
MFL55M1038V	1/4	38	3	1.2-3.0	10	5/8	100	3.54	73.36
HEAVY SECTION									
MFH55M1032V	12g	38	5	4.0-12.5	10	5/8	100	3.60	76.27



LIGHT SECTION

METALFIX HORIZONTAL HANGERS

- ☑ For Hanging Threaded Rods From Purlins, Light Steel Or Heavy Steel
- ☑ Fast Overhead Installation With A Screwgun
- ☑ Supplied Complete With Back-Nut For Additional Security

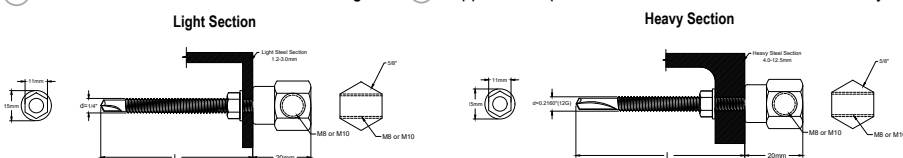

d=Thread Diameter L=Length



HEAVY SECTION

Part Number	Thread Diameter " d	Length mm L	Point Type	Steel Thickness	Internal Thread Diameter mm	Across Flats " A/F	Quantity Per Box	Ship Wt.Kg Per 100	Price £ Per 100
LIGHT SECTION									
MFL55M0825H	1/4	25	3	1.2-3.0	8	5/8	100	3.45	94.49
MFL55M1025H	1/4	25	3	1.2-3.0	10	5/8	100	3.30	93.53
MFL55M1038H	1/4	38	3	1.2-3.0	10	5/8	100	3.40	96.40
HEAVY SECTION									
MFH55M1032H	12g	38	5	4.0-12.5	10	5/8	100	3.10	94.71



GASH POINT VERTICAL HANGERS

- For Fixing Into Timber For Suspending Threaded Rod
- Fast Overhead Installation With A Screwgun
- Gash Point For Self-Drilling

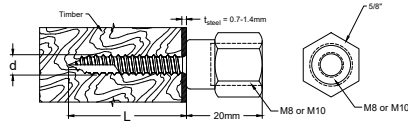

d=Thread Diameter L=Length t_{steel} =Steel Thickness

Part Number	Thread Diameter " d	Length mm L	Point Type	Steel Thickness t_{steel}	Internal Thread Diameter M	Across Flats " A/F	Quantity Per Box	Ship Wt.Kg Per 100	Price £ Per 100
GP63M0825V	1/4	25	-	0.7-1.4	8	5/8	100	3.26	70.35
GP63M0850V	1/4	50	-	0.7-1.4	8	5/8	100	3.00	72.97
GP63M1025V	1/4	25	-	0.7-1.4	10	5/8	100	3.50	67.01
GP63M1050V	1/4	50	-	0.7-1.4	10	5/8	100	3.30	69.71
GP79M1063V	1/3	63	-	0.7-1.4	10	5/8	100	3.88	79.79



GASH POINT HORIZONTAL HANGERS

- For Fixing Into Timber For Suspending Threaded Rod
- Fast Overhead Installation With A Screwgun
- Gash Point For Self-Drilling

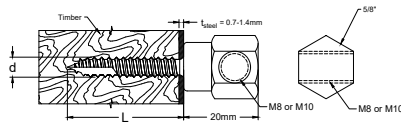

d=Thread Diameter L=Length t_{steel} =Steel Thickness

Part Number	Thread Diameter " d	Length mm L	Point Type	Steel Thickness t_{steel}	Internal Thread Diameter M	Across Flats " A/F	Quantity Per Box	Ship Wt.Kg Per 100	Price £ Per 100
GP63M0825H	1/4	25	-	0.7-1.4	8	5/8	100	3.31	89.11
GP63M1025H	1/4	25	-	0.7-1.4	10	5/8	100	2.90	88.04
GP63M1050H	1/4	50	-	0.7-1.4	10	5/8	100	3.40	93.13



SETTING TOOL FOR ROD HANGERS

- Install And Remove Internally Threaded Self-Drilling Rod Hangers
- 5/8" A/F

Part Number	Quantity Per Box	Ship Wt.Kg Per 100	Price £ Per Each
MF508RH	5	2.10	5.96



NAIL IN ANCHORS

A steel hammer-in fixing suitable for most solid base materials including re-inforced concrete, concrete blocks, brickwork and natural stone. Nail in anchors are non-removable and therefore vandal-proof.

- ✔ No Setting Tool Required
- ✔ Internally Tapered Body Gives Exceptional Grip
- ✔ Through Fixing
- ✔ Non-Cracked Concrete
- ✔ Hammer-In Expansion

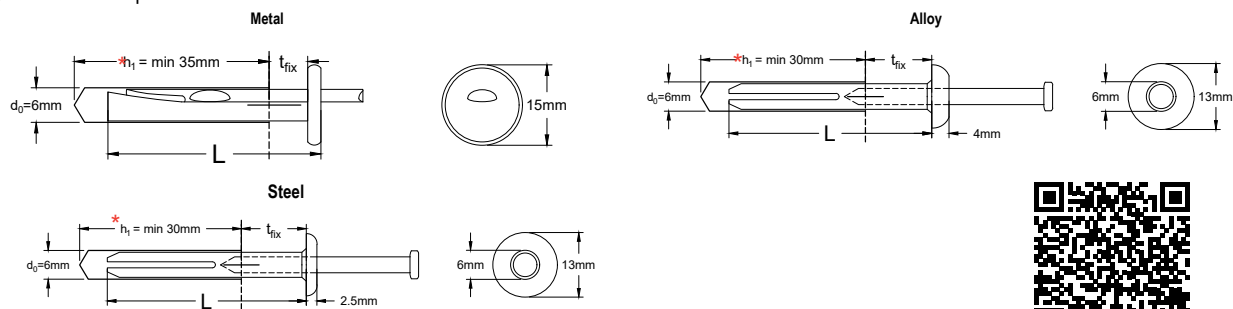

d_0 = Anchor Hole Size L = Anchor Length t_{fix} = Maximum Fixture Thickness $h1^*$ = Minimum Hole Depth

* See JCP Technical Data Sheet on www.jcpfixings.co.uk for details



NAIL IN ANCHORS METAL

METAL

- ✔ Suitable For Most Solid Base Materials
- ✔ Flush Finish
- ✔ Large Head Diameter Offers High Pull Over Strength For Thin Straps Or Brackets

Part Number	Anchor Hole Size mm d_0	Total Anchor Length mm L	Max Fixture Thickness mm t_{fix}	Flange Head Diameter mm	Quantity Per Box	Ship Wt.Kg Per 100	Price £ Per 100
MDA06040	6	40	5	15	100	1.40	12.12
MDA06065	6	65	30	15	100	1.60	20.82



NAIL IN ANCHORS ALLOY

ALLOY

- ✔ Suitable For Most Solid Base Materials
- ✔ Dome Flange Head

Part Number	Anchor Hole Size mm d_0	Total Anchor Length mm L	Max Fixture Thickness mm t_{fix}	Flange Head Diameter mm	Quantity Per Box	Ship Wt.Kg Per 100	Price £ Per 100
LANI06030	6	30	10	13	100	0.85	16.21
LANI06040	6	40	20	13	100	1.10	20.51
LANI06050	6	50	30	13	100	1.24	23.83



NAIL IN ANCHORS STEEL

STEEL

- ✔ Suitable For Most Solid Base Materials
- ✔ Increased Fire Resistance
- ✔ Dome Flange Head

Part Number	Anchor Hole Size mm d_0	Total Anchor Length mm L	Max Fixture Thickness mm t_{fix}	Flange Head Diameter mm	Quantity Per Box	Ship Wt.Kg Per 100	Price £ Per 100
MNI06030	6	30	10	13	100	0.85	33.12
MNI06040	6	40	20	13	100	1.10	34.39
MNI06050	6	50	30	13	100	1.24	37.99



CONSTRUCTION NAILS

Stainless steel and steel nails for building construction.

- Masonry Nails For Use In Concrete And Block
- Plastic Headed Nails For Use In Windows, Soffits And Fascias

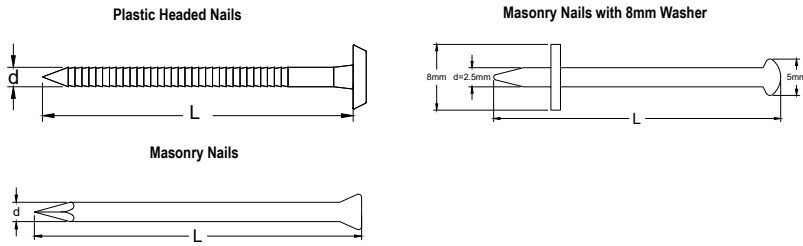

L=Length d=Shank Diameter

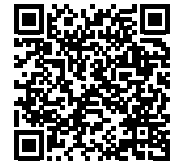

PLASTIC HEADED NAILS

**A4-316
STAINLESS STEEL**

- Available With Black Or White Heads To Match Soffit
- HDPE Impact Resistant Poly Head
- Ring Shanked
- UV Factor 5 Stabilised
- Maintenance Free
- Suitable For External Use And Marine Environments

Part Number	Shank Length mm L	Shank Diameter mm d	Head Colour	Quantity Per Box	Ship Wt.Kg Per 100	Price £ Per 100
POLY030WH	30	2.00	White	250	0.22	7.75
POLY040WH	40	2.00	White	250	0.29	8.79
POLY050WH	50	2.65	White	100	0.25	16.17
POLY065WH	65	3.35	White	100	0.48	23.79
POLY030BL	30	2.00	Black	250	0.22	7.21
POLY040BL	40	2.00	Black	250	0.29	8.38
POLY050BL	50	2.65	Black	100	0.25	15.08
POLY065BL	65	3.35	Black	100	0.48	22.92

MASONRY NAILS WITH WASHER

STEEL

- Manufactured From Austempered High Carbon Steel
- Hardened And Tempered
- Complete With Washer For Greater Pull Over
- Oil Bathed
- 8mm Diameter Washer

Part Number	Length mm L	Shank Diameter mm d	Quantity Per Box	Ship Wt.Kg Per 100	Price £ Per 100
AMNL025MP	25	2.5	200	0.13	7.50
AMNL030MP	30	2.5	200	0.15	8.00





MASONRY NAILS

STEEL

- Hardened And Tempered
- Manufactured From Austempered High Carbon Steel
- Versatile Nail Set By Hammer
- Oil Bathed

Part Number	Length mm L	Shank Diameter mm d	Quantity Per Box	Ship Wt.Kg Per 100	Price £ Per 100
LIGHT SHANK - COUNTERSUNK HEAD					
AMNL025	25	2.5	100	0.11	2.17
AMNL040	40	2.5	100	0.18	3.17
AMNL050	50	2.5	100	0.20	3.63
AMNL060	60	2.5	100	0.24	4.08
MEDIUM SHANK - COUNTERSUNK HEAD					
AMNM025	25	3.0	100	0.15	2.96
AMNM030	30	3.0	100	0.17	3.29
AMNM040	40	3.0	100	0.25	3.96
AMNM050	50	3.0	100	0.29	5.04
AMNM060	60	3.0	100	0.37	5.54
HEAVY SHANK - ROUND HEAD					
AMNH050	50	3.5	100	0.40	6.38
AMNH060	60	3.5	100	0.51	7.08
AMNH075	75	3.5	100	0.58	8.71
AMNH090	90	3.5	100	0.65	10.54
AMNH100	100	3.5	100	0.81	11.08

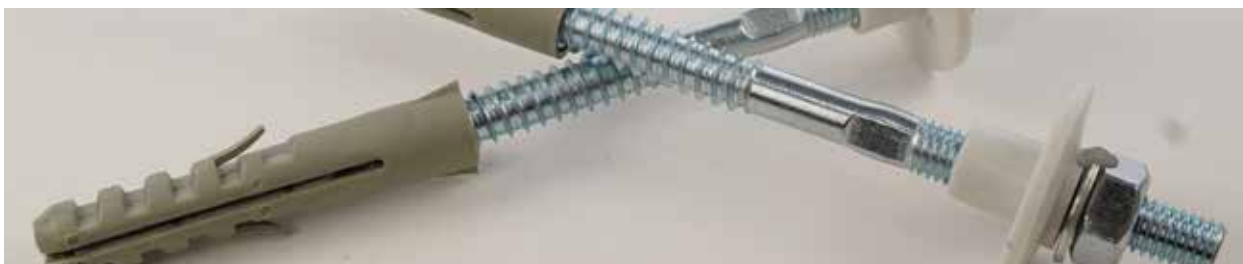

SANITARY FIXINGS

Complete fixing sets for wash basins, urinals, and sanitary installations.

- Complete With Cover Caps

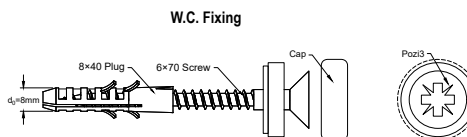
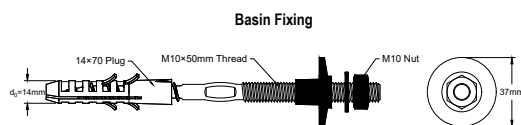

d_0 = Anchor Hole Diameter

BASIN FIXINGS

STEEL



Part Number	Screw Size mm	Plug Size mm	Anchor Hole Diameter mm d_0	Individual Quantity Per Box	Ship Wt.Kg Per 100	Individual £ Price Per 100	Price £ Per Bag of 2
NBFS10140	10.0 x 140	14 x 70	14	10	19	83.33	1.67



W.C FIXINGS

STEEL

Part Number	Screw Size mm	Plug Size mm	Colour	Anchor Hole Diameter mm d ₀	Individual Quantity Per Box	Ship Wt.Kg Per 100	Individual £ Price Per 100	Price £ Per Bag of 2
NWCW06070	6.0 x 70	8 x 40	White	8	50	3.4	55.17	1.10
NWCC06070	6.0 x 70	8 x 40	Chrome	8	50	3.4	55.17	1.10



BRACKETS

Vertical flange clips ideal for fixing suspended wire hangers to steel profiles.
Angle brackets for suspending lightweight ceilings and services.

- ✔ Flexible Positioning
- ✔ High Strength
- ✔ Simple Installation

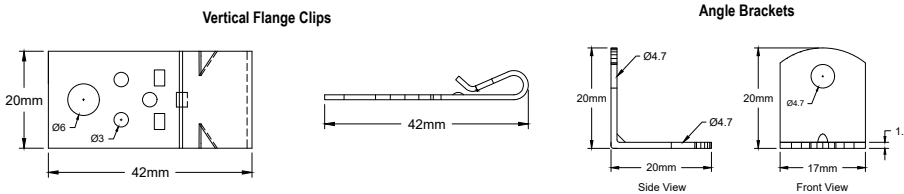
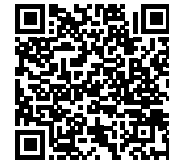

VERTICAL FLANGE CLIPS

- ✔ Fixes To A Range Of Steel Profiles
- ✔ Projecting Lugs For Secure Attachment
- ✔ Spring Steel Clip
- ✔ No Screws Required
- ✔ High Strength Steel



ZINC AND YELLOW PLATED

Part Number	Size mm	Min Purlin Gauge mm	Max Purlin Gauge mm	Height mm	Width mm	Quantity Per Box	Ship Wt.Kg Per 100	Price £ Per 100
VFC1	20 x 42	1.6	2.5	42	20	100	0.82	10.15

ANGLE BRACKETS

- ✔ Can Be Attached To Any Base Material
- ✔ Small And Lightweight
- ✔ Mild Steel

BRIGHT ZINC PLATED

Part Number	Size mm	Width mm	Hole Diameter mm	Thickness mm	Quantity Per Box	Ship Wt.Kg Per 100	Price £ Per 100
AB2020	20 x 20	17	4.7	1.2	100	0.51	4.40





WALL SCREWS

A light duty carbon steel fixing for use in concrete and masonry base materials, with fast and easy installation and no pre-drilling required.



- ✔ Undercutting Action With No Spinning Or Stripping
- ✔ Non-Cracked Concrete
- ✔ Reaction To Fire Class A1
- ✔ Masonry Base Materials
- ✔ Expansion Free
- ✔ Minimum 5µm

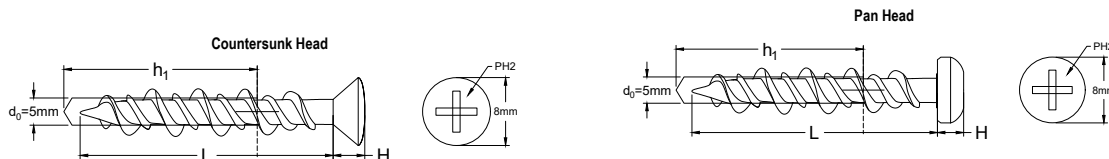

d_0 =Hole Diameter h_1 *=Minimum Hole Depth L=Shank Length H=Head Thickness

* See JCP Technical Data Sheet on www.jcpfixings.co.uk for details



COUNTERSUNK HEAD WALL SCREWS

STEEL

- ✔ Head Colour To Match Application
- ✔ Fast And Secure Installation

Part Number	Hole Diameter mm d_0	Thread Diameter mm	Shank Length mm L	Head Thickness mm H	Head Colour	Quantity Per Box	Ship Wt.Kg Per 100	Price £ Per 100
WS5032CSZ	5	6	32	4	Bright Zinc Plated	100	0.38	8.79
WS5038CSZ	5	6	38	4	Bright Zinc Plated	100	0.44	9.25
WS5050CSZ	5	6	50	4	Bright Zinc Plated	100	0.56	10.03
WS5032CSW	5	6	32	4	White	100	0.38	9.67
WS5038CSW	5	6	38	4	White	100	0.44	10.06
WS5050CSW	5	6	50	4	White	100	0.56	10.84



PAN HEAD WALL SCREWS

STEEL

- ✔ Head Colour To Match Application
- ✔ Fast And Secure Installation

Part Number	Hole Diameter mm d_0	Thread Diameter mm	Shank Length mm L	Head Thickness mm H	Head Colour	Quantity Per Box	Ship Wt.Kg Per 100	Price £ Per 100
WS5032PHZ	5	6	32	3	Bright Zinc Plated	100	0.38	8.79
WS5038PHZ	5	6	38	3	Bright Zinc Plated	100	0.44	9.25
WS5050PHZ	5	6	50	3	Bright Zinc Plated	100	0.56	10.03
WS5032PHW	5	6	32	3	White	100	0.38	9.67
WS5038PHW	5	6	38	3	White	100	0.44	10.06
WS5050PHW	5	6	50	3	White	100	0.56	10.84



BIGTWIST NAILS

A twist nail for fixing composite panels to wooden battens. The nail rotates during installation to reduce the risk of splitting timber.

- ✔ No Drilling Required
- ✔ Large 20mm Head
- ✔ Quick Installation
- ✔ Minimum 5µm

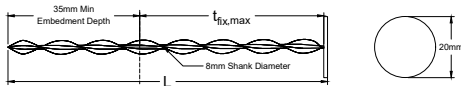

L=Anchor Length $t_{fix\ max}$ =Maximum Fixture Thickness



BIGTWIST NAILS

BRIGHT ZINC PLATED

- ✔ Unique One Piece Stress Free Fixing
- ✔ No Need For Screws
- ✔ Grade 8.8 High Tensile Steel
- ✔ Rotates During Installation To Reduce The Risk Of Splitting Timber

Part Number	Shank Diameter mm	Anchor Length mm L	Rec.Tensile Load kN	Max Fixture Thickness mm $t_{fix\ max}$	Quantity Per Bag/Box	Ship Wt.Kg Per 100	Price £ Per 100
TC08090BG	8	90	0.22	55	Bag of 25	1.40	49.86
TC08135BG	8	135	0.22	100	Bag of 25	2.14	57.04
TC08165BG	8	165	0.22	130	Bag of 25	2.30	65.42
TC08195BG	8	195	0.22	160	Bag of 25	2.80	76.39
TC08220BG	8	220	0.22	185	Bag of 25	3.00	85.37
TC08090BX	8	90	0.22	55	Box of 500	1.40	48.56
TC08135BX	8	135	0.22	100	Box of 500	2.14	56.30
TC08165BX	8	165	0.22	130	Box of 500	2.30	62.59
TC08195BX	8	195	0.22	160	Box of 500	2.80	73.52
TC08220BX	8	220	0.22	185	Box of 500	3.00	83.80



FIXING BANDS

For general strapping applications available in both straight and round formats, supplied in rigid plastic dispensers for ease of use.

- ✓ Easy To Cut
- ✓ Easy To Dispense
- ✓ Various Hole Configurations
- ✓ Stainless Steel For External Use

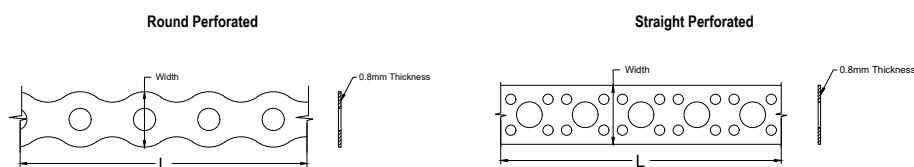

L=Length



FIXING BANDS

1 ROUND PERFORATED							
Part Number	Colour/Finish	Length M L	Width mm	Thickness mm	Quantity	Ship Wt.Kg	Price £ Per Each
FBR0312G	Mechanical Galvanised	3	12	0.8	1	0.16	2.23
FBR1012G	Mechanical Galvanised	10	12	0.8	1	0.48	5.12
FBR1017G	Mechanical Galvanised	10	17	0.8	1	0.72	6.69
2 STRAIGHT PERFORATED							
Part Number	Colour/Finish	Length M L	Width mm	Thickness mm	Quantity	Ship Wt.Kg	Price £ Per Each
FBS0312G	Mechanical Galvanised	3	12	0.8	1	0.16	2.52
FBS1012G	Mechanical Galvanised	10	12	0.8	1	0.48	5.70
FBS1019G	Mechanical Galvanised	10	19	0.8	1	1.10	7.96
3 ROUND PERFORATED							
Part Number	Colour/Finish	Length M L	Width mm	Thickness mm	Quantity	Ship Wt.Kg	Price £ Per Each
FBR1017SS	A2-304 Stainless Steel	10	17	0.8	1	0.72	19.22
4 PLASTIC COATED NEW							
Part Number	Colour/Finish	Length M L	Width mm	Thickness mm	Quantity	Ship Wt.Kg	Price £ Per Each
FB10W	White	10	12	0.8	1	0.55	10.95
FB10B	Black	10	12	0.8	1	0.55	10.95
FB10R	Red	10	12	0.8	1	0.55	11.50

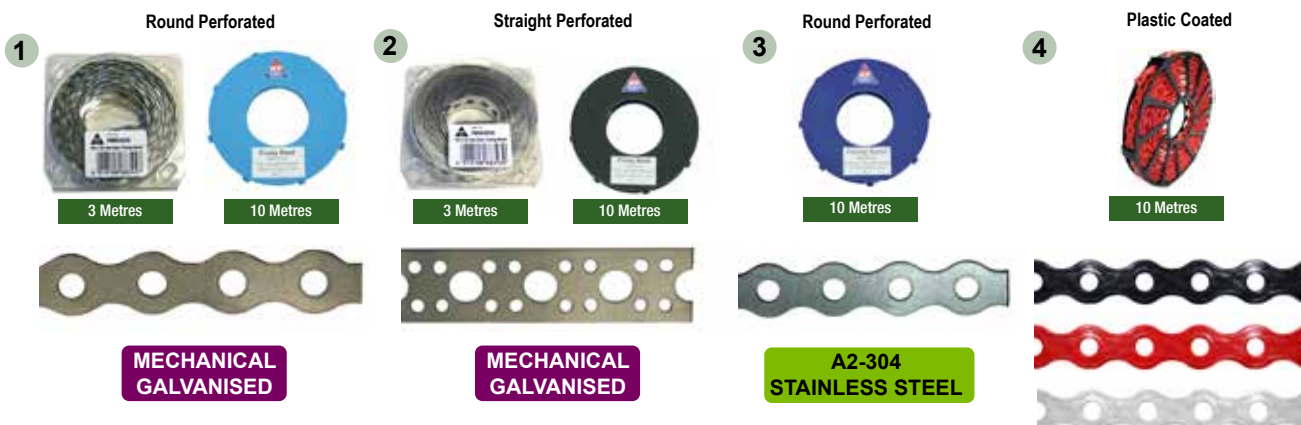



NYLON HAMMER SCREWS

A range of hammer in nylon screws, suitable for concrete and masonry.

- ✔ For Use In Timber Battens, Frame Ties, Electrical Boxes And Conduit Clips
- ✔ Ribbed Plug Manufactured From Polyamide PA6 Nylon
- ✔ Through Fixing

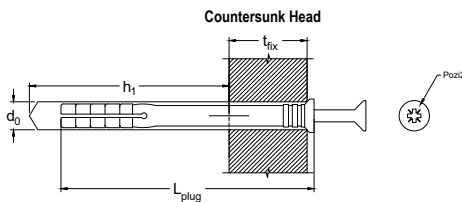

d_0 = Anchor Hole Size L_{plug} = Anchor Plug Length t_{fix} = Maximum Fixture Thickness h_1 = Minimum Hole Depth



COUNTERSUNK HEAD NYLON HAMMER SCREWS ZYP

ZINC AND YELLOW PLATED

- ✔ For Use In Concrete And Masonry
- ✔ Ideal For Fast Fixing Repetitive Applications
- ✔ Countersunk Head Gives A Flush Finish

Part Number	Anchor Hole Size mm d_0	Anchor Plug Length mm L_{plug}	Max Fixture Thickness mm t_{fix}	Min Hole Depth mm h_1	Quantity Per Box	Ship Wt.Kg Per 100	Price £ Per 100
NHS05030	5	30	5	30	100	0.35	3.92
NHS05050	5	50	25	30	100	0.40	5.46
NHS06040	6	40	10	35	100	0.47	4.64
NHS06050	6	50	20	35	100	0.55	6.02
NHS06060	6	60	30	35	100	0.63	6.45
NHS06070	6	70	40	35	100	0.83	7.04
NHS08060	8	60	20	45	100	1.01	10.15
NHS08080	8	80	40	45	100	1.26	13.42
NHS08100	8	100	60	45	50	1.56	15.75
NHS08120	8	120	80	45	50	1.89	18.82
NHS08140	8	140	100	45	50	2.22	20.68



FLANGE HEAD NYLON HAMMER SCREWS ZYP

ZINC AND YELLOW PLATED

- ✔ For Use In Concrete And Masonry
- ✔ Large Diameter Flange Head
- ✔ Flat Head Finish

Part Number	Anchor Hole Size mm d_0	Anchor Plug Length mm L_{plug}	Max Fixture Thickness mm t_{fix}	Min Hole Depth mm h_1	Head Diameter mm	Quantity Per Box	Ship Wt.Kg Per 100	Price £ Per 100
NHS06040FH	6	40	10	35	13	100	0.47	4.53



COUNTERSUNK HEAD NYLON HAMMER SCREWS A2 STAINLESS STEEL

**A2-304
STAINLESS STEEL**

- ✔ For Use In Concrete And Masonry
- ✔ Ideal For Fast Fixing Repetitive Applications
- ✔ Countersunk Head Gives A Flush Finish
- ✔ Suitable For External Use

Part Number	Anchor Hole Size mm d_h	Anchor Plug Length mm L_{plug}	Max Fixture Thickness mm t_{fix}	Min Hole Depth mm h_1	Quantity Per Box	Ship Wt.Kg Per 100	Price £ Per 100
NHS05030SS	5	30	5	30	200	0.35	11.15
NHS06040SS	6	40	10	35	200	0.47	11.89
NHS06060SS	6	60	30	35	100	0.63	17.42
NHS06070SS	6	70	40	35	100	0.74	20.06
NHS08060SS	8	60	20	45	100	1.01	28.53
NHS08080SS	8	80	40	45	100	1.26	25.28
NHS08100SS	8	100	60	45	50	1.56	25.86



MUSHROOM HEAD NYLON HAMMER SCREWS

- ✔ For Use In Concrete And Masonry
- ✔ Suitable For External Use
- ✔ Mushroom Head Gives A Low Profile Finish

Part Number	Anchor Hole Size mm	Anchor Length mm	Max Fixture Thickness mm	Min Hole Depth mm	Head Diameter mm	Quantity Per Box	Ship Wt.Kg Per 100	Price £ Per 100
NNP06040	6	40	7	50	13	100	0.35	11.19



TRAINING

Our technical team offer training sessions to provide a hands-on-experience with our fixings. Sessions are tailored to meet the needs of the audience and can also be delivered virtually.

Who Should Attend?



Construction Professionals



Civil and Structural Engineers



Architects

BASIC TRAINING

 2-3 Hours

ADVANCED TRAINING

 5-6 Hours

FOR MORE INFORMATION CALL OUR TECHNICAL HELPLINE ON 020 8943 1800



NYLON FRAME FIXINGS

The nylon frame fixing includes a matched screw and extended plug for anchoring timber to a wide variety of materials.

- ✔ For Fixing Timber Frames, Battens, Windows And Other Wooden Products To Concrete And Masonry
- ✔ High-Expansion Ratio
- ✔ Ribbed Plug Manufactured From Polyamide PA6 Nylon
- ✔ Through Fixing

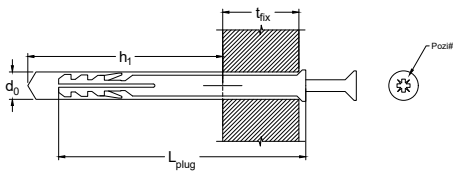

d_0 = Anchor Hole Size L_{plug} = Anchor Plug Length t_{fix} = Maximum Fixture Thickness h_1 = Minimum Hole Depth

COUNTERSUNK NYLON FRAME FIXINGS ZYP

ZINC AND YELLOW PLATED

- ✔ For Use In Solid Base Materials
- ✔ Countersunk Head Gives A Flush Finish
- ✔ Strong Grip In Weaker Materials



Part Number	Anchor Hole Size mm d_0	Anchor Plug Length mm L_{plug}	Max Fixture Thickness mm t_{fix}	Min Hole Depth mm h_1	Quantity Per Box	Ship Wt.Kg Per 100	Price £ Per 100
NFF08060	8	60	20	45	100	1.24	12.28
NFF08080	8	80	40	45	100	1.56	15.89
NFF08100	8	100	60	45	100	1.70	19.01
NFF08120	8	120	80	45	100	1.89	23.14
NFF10080	10	80	35	50	100	2.40	27.28
NFF10100	10	100	55	50	100	3.44	32.23
NFF10120	10	120	75	50	100	3.80	38.90
NFF10140	10	140	95	50	100	4.36	41.82
NFF10160	10	160	115	50	100	5.16	48.03

ETA COUNTERSUNK HEAD NYLON FRAME FIXINGS BZP



- ✔ For Use In Solid And Hollow Base Materials
- ✔ Countersunk Head Gives A Flush Finish
- ✔ Fire Resistance Loading
- ✔ TX Drive: 8mm - T30, 10mm - T40
- ✔ Tested To ETAG 020-01, Plastic Anchors For Multiple Use For Non-Structural Application

BRIGHT ZINC PLATED



Part Number	Anchor Hole Size mm d_0	Anchor Plug Length mm L_{plug}	Max Fixture Thickness mm t_{fix}	Min Hole Depth mm h_1	Quantity Per Box	Ship Wt.Kg Per 100	Price £ Per 100
NFF08080ETA	8	80	10	90	100	1.83	42.98
NFF08100ETA	8	100	30	90	100	2.28	48.23
NFF08120ETA	8	120	50	90	100	2.76	60.60
NFF08140ETA	8	140	70	90	50	3.24	75.25
NFF10080ETA	10	80	10	90	50	2.47	50.04
NFF10100ETA	10	100	30	90	50	3.14	61.91
NFF10120ETA	10	120	50	90	50	3.79	67.52
NFF10140ETA	10	140	70	90	50	4.43	82.02
NFF10160ETA	10	160	90	90	50	5.06	107.13



ETA HEXAGON HEAD NYLON FRAME FIXINGS BZP

- ✓ For Use In Solid And Hollow Base Materials
- ✓ Fire Resistance Loading
- ✓ Tested To ETAG 020-01, Plastic Anchors For Multiple Use For Non-Structural Application



**BRIGHT ZINC
PLATED**

Part Number	Anchor Hole Size mm d_0	Anchor Plug Length mm L_{plug}	Max Fixture Thickness mm t_{fix}	Min Hole Depth mm h_1	Quantity Per Box	Ship Wt.Kg Per 100	Price £ Per 100
NFF08080ETAH	8	80	10	90	100	2.10	47.16
NFF08100ETAH	8	100	30	90	100	2.57	54.89
NFF08120ETAH	8	120	50	90	100	3.06	72.02
NFF08140ETAH	8	140	70	90	50	3.44	92.70
NFF10080ETAH	10	80	10	90	50	3.08	60.00
NFF10100ETAH	10	100	30	90	50	3.75	73.01
NFF10120ETAH	10	120	50	90	50	4.43	95.89
NFF10140ETAH	10	140	70	90	50	5.32	122.55
NFF10160ETAH	10	160	90	90	50	5.71	163.55



ETA COUNTERSUNK HEAD NYLON FRAME FIXINGS A4 STAINLESS STEEL

- ✓ For Use In Solid And Hollow Base Materials
- ✓ Countersunk Head Gives A Flush Finish
- ✓ Fire Resistance Loading
- ✓ TX Drive: 8mm - T30, 10mm - T40
- ✓ Tested To ETAG 020-01, Plastic Anchors For Multiple Use For Non-Structural Application
- ✓ Suitable For External Use And Marine Environments



**A4-316
STAINLESS STEEL**

Part Number	Anchor Hole Size mm d_0	Anchor Plug Length mm L_{plug}	Max Fixture Thickness mm t_{fix}	Min Hole Depth mm h_1	Quantity Per Box	Ship Wt.Kg Per 100	Price £ Per 100
NFF08080ETASS	8	80	10	90	100	1.83	145.25
NFF08100ETASS	8	100	30	90	100	2.29	173.44
NFF08120ETASS	8	120	50	90	100	2.80	202.20
NFF08140ETASS	8	140	70	90	50	3.25	283.79
NFF10080ETASS	10	80	10	90	50	2.59	200.71
NFF10100ETASS	10	100	30	90	50	3.25	235.82
NFF10120ETASS	10	120	50	90	50	3.85	270.74
NFF10140ETASS	10	140	70	90	50	4.48	346.38
NFF10160ETASS	10	160	90	90	50	5.02	413.44



PLUGS

A range of plastic and metal plugs for various applications.

- ✔ Different Strengths Available
- ✔ Allow For Secure Fixings
- ✔ Standard And Premium Range Available



PUSH PLUGS

- ✔ For Retaining Damp-Proof Membranes
- ✔ No Expansion Forces
- ✔ Corrosion Resistant
- ✔ Grips The Hole With Flexible Wings

Part Number	Anchor Hole Size mm	Anchor Plug Length mm	Max Fixture Thickness mm	Min Hole Depth mm	Head Diameter mm	Quantity Per Box	Ship Wt.Kg Per 100	Price £ Per 100
PP06035	6	35	5	45	13	100	0.10	4.16

NYLON WALL PLUGS

- ✔ For Use In Solid Base Materials
- ✔ Suitable For Wood And Chipboard Screws
- ✔ 2 Way Expansion
- ✔ Screw Guidance
- ✔ Rimless

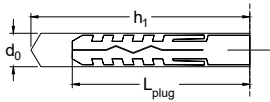

Part Number	Anchor Hole Size mm d_0	Anchor Plug Length mm L_{plug}	Woodscrew Gauge No mm	Metric Screw Size mm	Min Hole Depth mm h_1	Quantity Per Box	Ship Wt.Kg Per 100	Price £ Per 100
NP05	5	25	4-6	2.5-3.5	30	100	0.04	1.87
NP06	6	30	6-10	3.5-5.0	35	100	0.08	2.02
NP07	7	35	8-12	4.0-5.5	40	100	0.12	2.43
NP08	8	40	10-14	5.0-6.0	45	100	0.15	3.08
NP10	10	50	14-18	6.0-8.0	55	50	0.29	5.56
NP12	12	60	18-24	8.0-10.0	70	25	0.52	10.65
NP14	14	70	24-32	10.0-12.0	80	20	0.74	15.14

UNIVERSAL WALL PLUGS

- ✔ For Use In Solid And Hollow Base Materials

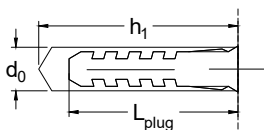

d_0 =Anchor Hole Size L_{plug} =Anchor Plug Length h_1 =Minimum Hole Depth

Part Number	Anchor Hole Size mm d_0	Anchor Plug Length mm L_{plug}	Woodscrew Gauge No mm	Metric Screw Size mm	Min Hole Depth mm h_1	Quantity Per Box	Ship Wt.Kg Per 100	Price £ Per 100
NUP06035	6	40	6-8	3.5-4.0	45	200	0.04	2.68
NUP08050	8	50	10-12	4.5-5.5	55	100	0.12	5.19
NUP10060	10	60	12-14	5.5-6.0	65	50	0.15	7.83



PREMIUM NYLON WALL PLUGS

- ✔ For Use In Solid And Hollow Base Materials
- ✔ Suitable For Wood And Chipboard Screws
- ✔ 2 Way Expansion
- ✔ Rimless
- ✔ Anti-Rotation Lugs
- ✔ Castellated Split Guides Screw To Keep It Inside Plug

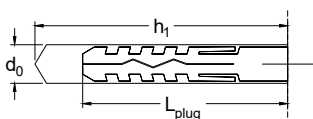

d_0 =Anchor Hole Size L_{plug} =Anchor Plug Length h_1 =Minimum Hole Depth

Part Number	Anchor Hole Size mm d_0	Anchor Plug Length mm L_{plug}	Woodscrew Gauge No mm	Metric Screw Size mm	Min Hole Depth mm h_1	Quantity Per Box	Ship Wt.Kg Per 100	Price £ Per 100
NP06030	6	30	6-10	3.5-5.0	35	100	0.04	1.85
NP06055	6	55	6-10	3.5-5.0	60	100	0.07	2.22
NP08040	8	40	10-14	4.5 - 6.0	45	100	0.10	2.34
NP08060	8	60	10-14	4.5 - 6.0	70	100	0.16	3.03
NP10080	10	80	14-18	6.0 - 8.0	90	100	0.30	5.78
NP12055	12	55	18-24	8.0 - 10.0	60	100	0.26	4.73

JCP STANDARD PLASTIC PLUGS

- ✔ Supplied On A Sprue
- ✔ For Use In Solid And Hollow Base Materials
- ✔ Supplied In Outers Of 1,000
- ✔ Suitable For Standard Trade Requirements

Part Number	Colour	Drill Diameter mm	Plug Length mm	Woodscrew Gauge No mm	Metric Screw Size mm	Min Hole Depth mm	Quantity Per Box	Ship Wt.Kg Per 100	Price £ Per 1000
AYP	Yellow	5	22	4-8	2.5-4.0	30	100	0.40	11.23
ARP	Red	5.5	30	6-10	3.5-5.0	40	100	0.64	11.38
ABP	Brown	7	37	10-14	5.0-6.0	45	100	1.12	16.27



AYP



ARP



ABP

JCP BULK PLASTIC PLUGS

- ✔ Supplied Loose

Part Number	Colour	Drill Diameter mm	Plug Length mm	Woodscrew Gauge No mm	Metric Screw Size mm	Min Hole Depth mm	Quantity Per Box	Ship Wt.Kg Per 100	Price £ Per 1000
LBARP	Red	6	37	6-10	3.5-5.0	40	10000	1.05	9.50
LBABP	Brown	7	37	10-14	5.0-6.0	45	5000	1.35	13.46



FREE, NEXT-DAY DELIVERY WITH LOW MINIMUM ORDER LEVELS ACROSS THE MAJORITY OF THE UK MAINLAND.

JCP PREMIUM PLASTIC PLUGS

- ✓ Supplied On A Sprue ✓ For Use In Concrete And Masonry Base Materials ✓ Supplied In Outers Of 1,000
- ✓ Suitable For Wood And Chipboard Screws

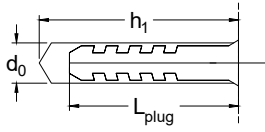

d_0 =Anchor Hole Size L_{plug} =Anchor Plug Length h_1 =Minimum Hole Depth

Part Number	Colour	Drill Diameter mm d_0	Plug Length mm L_{plug}	Woodscrew Gauge No mm	Metric Screw Size mm	Min Hole Depth mm h_1	Quantity Per Box	Ship Wt.Kg Per 100	Price £ Per 1000
JCPRED	Red	6	37	6-10	3.5-5.0	45	100	1.05	13.19
JCPBROWN	Brown	7	37	10-14	5.0-6.0	45	100	1.35	17.50



JCPRED



JCPBROWN



METAL EXPANSION PLUGS

- ✓ For Use In Concrete, Masonry And Aerated Concrete Blocks ✓ 4 Segment Design ✓ For Use With Woodscrews

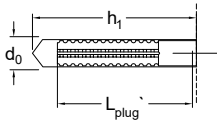

Part Number	Drill Diameter mm d_0	Plug Length mm L_{plug}	Screw Size mm	Min Hole Depth mm h_1	Quantity Per Box	Ship Wt.Kg Per 100	Price £ Per 100
MP05030	5	30	4.5	40	100	0.20	5.37
MP06032	6	32	4.5-5.0	40	100	0.20	6.16
MP08038	8	38	5.0-6.0	50	100	0.60	10.14
MP08060	8	60	5.0-6.0	70	50	1.00	12.70



CAVITY FIXINGS

A range of fixings to suit all plasterboard and cavity applications.

- ✔ Secure And Solid Fixing
- ✔ All-Metal, Nylon And Spring Toggles Available

J-PLUG PLASTERBOARD FIXINGS

- ✔ Comes Complete With Screw
- ✔ Self-Drilling
- ✔ Compatible With Hand Or Power Screwdrivers

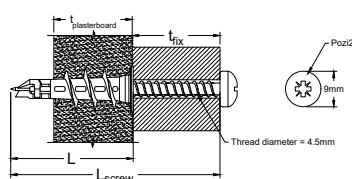

L_{screw} = Screw Length t_{fix} = Maximum Fixture Thickness

Part Number	Screw Thread Diameter mm	Screw Length mm L_{screw}	Max. Fixture Thickness mm t_{fix}	Hole Depth mm	Quantity Per Box	Ship Wt.Kg Per 100	Price £ Per 100
JJP15	4.5	35	15	37	100	0.50	17.73
JJP30	4.5	50	30	37	100	0.60	19.28
JJP15A	4.5	35	15	32	100	0.50	16.95
JJP30A	4.5	50	30	32	100	0.65	17.93
JJPN10A	4.5	30	10	29	100	0.20	8.27



JJP15/30
Zinc Alloy



JJP15A/30A
Zinc Alloy



JJPN10A
Nylon

ROSETT CAVITY FIXINGS

For use in plasterboard and other materials where a fixing into a cavity is required.

- ✔ Single And Double Skin Plasterboard Options Available
- ✔ Heavy Duty
- ✔ 30% Glass Fibre Re-Enforced Thread
- ✔ Minimum 5µm

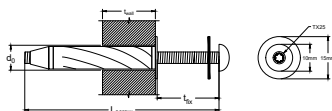

L_{screw} = Screw Length t_{wall} = Wall Thickness t_{fix} = Maximum Fixture Thickness d_0 = Hole Diameter

Part Number	Screw Length mm L_{screw}	Wall Thickness mm t_{wall}	Max. Fixture Thickness mm t_{fix}	Hole Diameter mm d_0	Quantity Per Box	Ship Wt.Kg Per 100	Price £ Per 100
BR05055	55	9-18	15	10	25	1.17	70.26
BR05080	85	9-18	40	10	25	1.49	74.66
RR05065	65	18-30	12	10	25	1.35	73.57
RR05090	90	18-30	38	10	25	1.66	80.96
BRHOOK	-	9-18	-	10	25	1.55	113.26
RRHOOK	-	18-30	-	10	25	1.78	114.71



BR05055
Pan Head



RR05065
Pan Head



BRHOOK
Hook



RRHOOK
Hook



ANKERNUTS

- ✔ For Use In Hollow Materials And Occasional Use In Solid Materials
- ✔ Flange Head
- ✔ Vibration Resistant
- ✔ Synthetic Rubber Sleeve (EPDM) With Brass Threaded Insert
- ✔ Ideal For Irregular Shaped Holes

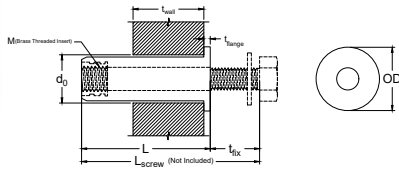

M=Thread Diameter d₀=Hole Diameter t_{wall}=Wall Thickness L=Length t_{flange}=Flange Thickness OD=Flange Diameter

Part Number	Thread Diameter M	Hole Diameter mm d ₀	Wall Thickness mm t _{wall}	Length mm L	Flange Thickness mm t _{flange}	Flange Diameter mm OD	Rec. Tightening Torque mm	Quantity Per Box	Ship Wt.Kg Per 100	Price £ Per 100
LNN03024	3	8	2.0-15.0	24	1	11	1	50	0.17	23.55
LNN04011	4	8	0.4-2.0	13	1	11	1	50	0.19	23.08
LNN04024	4	8	2.0-15.0	25	1	11	1	50	0.30	23.55
LNN05015	5	10	0.4-4.0	14	1	13	1.8	50	0.24	27.74
LNN05025	5	10	8.0-16.0	25	1.3	14	1.8	50	0.36	33.83
LNN05040	5	10	20.0-30.0	40	1.3	14	1.8	50	0.40	35.05
LNN06015	6	13	0.4-3.0	15	1.3	16	4	50	0.42	47.54
LNN06025	6	13	6.0-12.0	25	1.3	16	4	50	0.58	37.47
LNN06035	6	13	12.0-25.0	35	1.3	16	4	50	0.78	41.52
LNN06050	6	13	25.0-40.0	50	1.3	16	4	50	0.85	47.54
LNN08025	8	18	4.0-10.0	25	1.3	22	8	50	1.12	67.45
LNN08050	8	18	25.0-35.0	50	1.6	20	8	50	1.88	75.30
LNN10055	10	20	25.0-35.0	55	1.3	22.5	10	25	2.28	160.30
LNN12075	12	24	35.0-45.0	75	1.3	27	15	20	4.00	219.12
LNN12125	12	24	35.0-45.0	125	1.3	27	15	20	7.50	355.35

ROAD FIXING KIT

- ✔ For Attaching Fixtures To Tarmac
- ✔ Complete With Bolt
- ✔ For Fixing Down Speed Ramps, Smoking Shelters, Bicycle Storage Racks And Other Non-Structural Applications



Part Number	Description	Price £ Per Each
RFK12125	4 x M12 x 125 Ankernuts C/W M12 x 160 Set Bolt and Washer	21.32



FREE, NEXT-DAY DELIVERY WITH LOW MINIMUM ORDER LEVELS ACROSS THE MAJORITY OF THE UK MAINLAND.

ZINC AND YELLOW PLATED

HOLLOW WALL ANCHORS ZYP

- ✔ Provides A Strong, Permanent Anchorage To Plasterboard And Other Partition Materials
- ✔ Five Way Expansion
- ✔ All Metal Expanding Cavity Anchor
- ✔ Anti-Rotation Lugs
- ✔ Flange Head
- ✔ Complete With Pan Head Screws

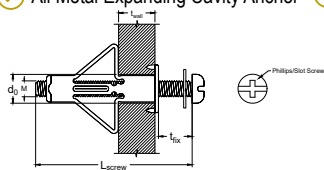

L_{screw} = Screw Size t_{wall} = Wall Thickness t_{fix} = Maximum Fixture Thickness d_0 = Hole Diameter M^* = Thread Diameter
M = See the technical data sheet on www.jcifixings.co.uk for details*

Part Number	Screw Size mm L_{screw}	Wall Thickness mm t_{wall}	Max Fixture Thickness mm t_{fix}	Hole Diameter mm d_0	Quantity Per Box	Ship Wt.Kg Per 100	Price £ Per 100
LHWA04025	M4 X 25	0-4	10	7	100	0.46	12.36
LHWA04045	M4 X 45	8-13	15	7	100	0.75	12.69
LHWA04050	M4 X 50	16-20	15	7	100	0.86	14.03
LHWA04065	M4 X 65	22-27	30	7	100	0.96	16.15
LHWA05045	M5 X 45	5-10	15	9	100	1.35	19.17
LHWA05060	M5 X 60	5-13	23	9	50	1.68	22.56
LHWA05070	M5 X 70	17-25	23	9	50	1.80	25.09
LHWA06060	M6 X 60	7-13	23	10	50	2.22	28.06
LHWA06070	M6 X 70	16-24	24	10	50	2.68	31.90

HOLLOW WALL ANCHOR SETTING TOOL

- ✔ For Rapid Installation Of Hollow Wall Anchors
- ✔ Eliminates The Need For A Screwdriver



Part Number	Quantity Per Box	Ship Wt.Kg Per 100	Price £ Per Each
LHWAST	1	0.45	14.30

SPRING TOGGLES ZYP

ZINC AND YELLOW PLATED

- ✔ Can Be Used In Virtually Any Cavity Or Blind Fixing Situation From Hardboard To Hollow Steel Sections
- ✔ Various Sizes To Suit Different Wall Thicknesses
- ✔ Complete With Screws

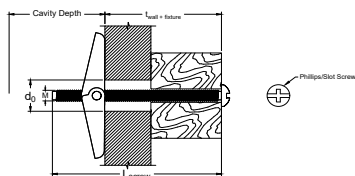

M = Thread Diameter L_{screw} = Screw Length $t_{wall+ fixture}$ = Wall and Fixture Thickness d_0 = Hole Diameter

Part Number	Thread Diameter M	Screw Length mm L_{screw}	Wall and Fixture Thickness mm $t_{wall+ fixture}$	Cavity Depth mm	Hole Diameter mm d_0	Quantity Per Box	Ship Wt.Kg Per 100	Price £ Per 100
LST03050	3	50	30	20	11	100	0.52	20.71
LST05050	5	50	20	30	14	100	1.27	23.38
LST05075	5	75	45	30	14	100	1.62	29.27
LST05100	5	100	70	30	14	100	1.88	30.48
LST06075	6	75	45	30	18	100	2.58	39.66



SPRING TOGGLES (WINGS ONLY) ZYP

ZINC AND YELLOW PLATED

✔ Can Be Used In Virtually Any Cavity Or Blind Fixing Situation ✔ Various Sizes To Suit Different Wall Thicknesses

Part Number	Thread Diameter M	Cavity Depth mm	Hole Diameter mm	Quantity Per Box	Ship Wt.Kg Per 100	Price £ Per 100
LSTM03	3	20	11	100	0.34	9.80
LSTM05	5	30	14	100	0.63	11.35
LSTM06	6	30	18	100	0.97	13.83
LSTM08	8	40	22	50	1.66	29.41
LSTM10	10	40	25	50	2.64	31.96



PLASTIC TOGGLES

✔ For Use In Hollow And Cavity Applications ✔ Quick And Easy To Apply ✔ Use With Standard Woodscrew ✔ Light Duty Applications

Part Number	Woodscrew Size mm	Woodscrew Gauge mm	Wall Thickness mm	Minimum Cavity Depth mm	Hole Diameter mm	Quantity Per Box	Ship Wt.Kg Per 100	Price £ Per 100
NT10	4.5	8	4-12	30	10	100	0.23	11.01
NT12	4.5	8	15-19	35	10	100	0.25	11.97
NT16	4.5	8	24-28	40	10	100	0.25	12.95



PLASTERBOARD PLUGS NEW

✔ Short Length Ideal For Dry Lined Walls ✔ Flange Head Prevents Push Through

Part Number	Woodscrew Size mm	Woodscrew Gauge mm	Wall Thickness mm	Minimum Cavity Depth mm	Hole Diameter mm	Quantity Per Box	Ship Wt.Kg Per 100	Price £ Per 100
PPLUG	4.5	8	4-12	30	7	100	0.23	4.00

NEW PACKAGING INTRODUCED TO THE GAS NAILS RANGE



CLIPPED HEAD DRIVEFAST GAS NAILS



CLIPPED HEAD HANDI PACK DRIVEFAST GAS NAILS

BRAD NAILS AND GAS





GAS NAILS

A range of gas nails and fuel cell packs for fixing timber to timber (first fix).

- ✓ Highest Quality
- ✓ CE Marked
- ✓ Additional Fuel Cells Available
- ✓ Stainless Steel For External Use



CLIPPED HEAD DRIVEFAST GAS NAILS

- ✓ 34° Angled Clipped Head Nails
- ✓ Includes 2 Fuel Cell Packs
- ✓ Conform To Eurocode 5 Service Class 1
- ✓ 1 Fuel Cell Per 1,100 Nails
- ✓ Suitable For Use In Drivefast DF90, IM350, NR90GC2, GN900S, WW90CH, GS690CH, GT90CH And D90S



Part Number	Nail Length mm	Shank Diameter mm	Description	Quantity Per Box	Ship Wt.Kg Per Box	Price £ Per Box
IM35051RB	51	2.8	1 Ring Bright	2200	10.50	65.73
IM35063RB	63	2.8	1 Ring Bright	2200	12.10	73.33
IM35075RB	75	3.1	1 Ring Bright	2200	12.60	85.71
IM35051EG	51	2.8	2 Ring Electro Galv	2200	10.50	72.42
IM35063EG	63	2.8	2 Ring Electro Galv	2200	12.10	81.77
IM35075EG	75	3.1	2 Ring Electro Galv	2200	12.60	84.50
IM35063RG	63	2.8	3 Ring Hot Dip Galv	2200	12.10	85.00
IM35075RG	75	3.1	3 Ring Hot Dip Galv	2200	12.60	87.63
IM35090SB	90	3.1	4 Smooth Bright	2200	12.60	78.65
IM35090EG	90	3.1	5 Smooth Electro Galv	2200	12.60	99.55
IM35090SG	90	3.1	6 Screwed Electro Galv	2200	12.60	106.61

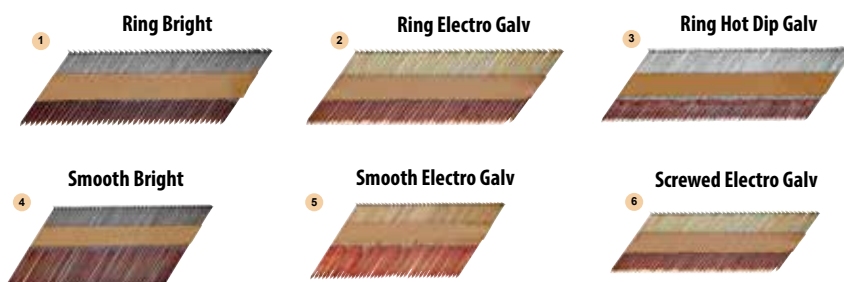

STAINLESS STEEL CLIPPED HEAD DRIVEFAST GAS NAILS



- ✓ 34° Angled Clipped Head Nails
- ✓ Includes Fuel Cell Pack
- ✓ Conform To Eurocode 5 Service Classes 1, 2, And 3
- ✓ 1 Fuel Cell Per 1,000 Nails
- ✓ Suitable For External Use



A2-304 STAINLESS STEEL

Part Number	Nail Length mm	Shank Diameter mm	Quantity Per Box	Ship Wt.Kg Per Box	Price £ Per Box
IM35051SS	51	2.8	1000	4.75	124.42
IM35063SS	63	2.8	1000	4.80	161.29
IM35080SS	80	3.1	1000	5.75	175.00
IM35090SS	90	3.1	1000	6.00	191.21





CLIPPED HEAD HANDI PACK DRIVEFAST GAS NAILS

- ✔ 34° Angled Clipped Head Nails
- ✔ Includes Fuel Cell Pack
- ✔ Conform To Eurocode 5 Service Class 1
- ✔ 1 Fuel Cell Per 1,000 Nails



Part Number	Nail Length mm	Shank Diameter mm	Description	Quantity Per Box	Ship Wt.Kg Per Box	Price £ Per Box
HAN51RB	51	2.8	1 Ring Bright	1000	4.75	33.33
HAN63RB	63	2.8	1 Ring Bright	1000	4.75	34.92
HAN75RB	75	2.8	1 Ring Bright	1000	4.75	36.58
HAN51EG	51	2.8	2 Ring Electro Galv	1000	4.75	35.46
HAN63EG	63	2.8	2 Ring Electro Galv	1000	4.75	41.67
HAN75EG	75	3.1	2 Ring Electro Galv	1000	6.00	46.04
HAN90SB	90	3.1	3 Smooth Bright	1000	6.00	41.67
HAN90EG	90	3.1	4 Smooth Electro Galv	1000	6.00	51.79
HAN90SG	90	3.1	5 Screwed Electro Galv	1000	6.00	52.00

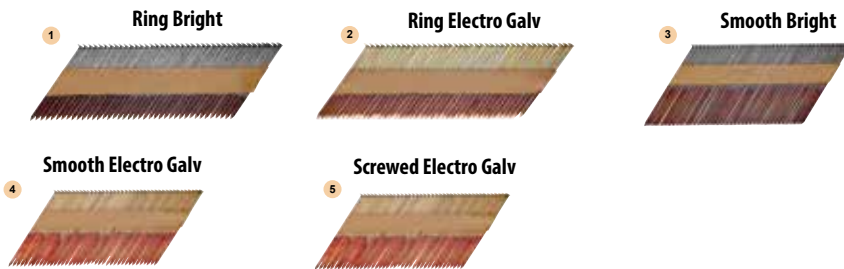

BRAD NAILS AND GAS



- ✔ Suitable For Use In IM250, NT65GS And DC616KB
- ✔ Includes 2 Fuel Cell Packs
- ✔ 1 Fuel Cell Per 1000 Nails
- ✔ Conform To Eurocode 5 Service Classes 1, 2, And 3



16 Gauge Galvanised Straight Brad Nails							
Part Number	Nail Length mm	Shank Diameter mm	Description	Quantity Per Outer Box	Quantity Per Inner Box	Ship Wt.Kg Per Box	Price £ Per Box
IM25038G	38	F16	Straight Brad	8000	2000	5.00	36.00
IM25050G	50	F16	Straight Brad	8000	2000	7.00	52.58
IM25064G	64	F16	Straight Brad	8000	2000	8.00	58.33
A2-304 Stainless Steel Straight Brad Nails							
Part Number	Nail Length mm	Shank Diameter mm	Description	Quantity Per Outer Box	Quantity Per Box	Ship Wt.Kg Per Box	Price £ Per Box
IM25038SS	38	F16	Straight Brad	-	2000	5.00	366.83
IM25050SS	50	F16	Straight Brad	-	2000	7.00	458.33
16 Gauge Galvanised Angled Brad Nails							
Part Number	Nail Length mm	Shank Diameter mm	Description	Quantity Per Outer Box	Quantity Per Box	Ship Wt.Kg Per Box	Price £ Per Box
IM25038A	38	F16	Angled Brad	-	2000	5.00	39.17
IM25050A	50	F16	Angled Brad	-	2000	7.00	46.17



DRIVEFAST GAS ONLY

- ✔ To Suit The Drivefast DF90 And The Paslode IM350
- ✔ Mix Of Propane And Butane To Optimise Performance
- ✔ Contains A Top Grade Mobil Fully Synthetic Lubrication Oil To Protect The Tool

Part Number	Description	Quantity Per Inner Box	Price £ Per Each
IMGAS250	To suit IM250/IM250A	1	16.67
IMGAS350	To suit IM350/DF90	1	17.29



IMGAS250 IMGAS350



CARTRIDGE TOOLS AND ACCESSORIES

Cartridge tool, strips and pins for fastening wood or sheet metal to concrete, steel or brick.

- ✓ Easy Installation
- ✓ Strong Fixing
- ✓ Concrete, Steel And Masonry Subject To Correct Selection And Application



CEILING HANGERS

- ✓ Suspension Clip Suitable For 8mm Cartridge Tools

Part Number	Shank Diameter mm	Shank Length mm	Quantity Per Box	Ship Wt.Kg Per 100	Price £ Per 100
VCH32	3.8	32	100	0.64	27.10

PA97 CARTRIDGE TOOL KIT

Strip feed tool with power adjuster suitable for 12mm metal washered drive pins up to 97mm long. (82mm and 97mm pins require pre-driving).



- ✓ A Low Velocity, Indirect Acting Tool
- ✓ Comes Complete With Carry Case
- ✓ Portable And Robust
- ✓ Spare Parts Available

Part Number	Description	Quantity Per Unit	Ship Wt.Kg Per Each	Price £ Per Each
PA97KIT	Strip Feed Cartridge Tool C/W Kit in Toolbox	1	4.90	695.00



PA97



Safety Goggles



Retaining Ring



Spall Shield



Stop Ring



Cleaning Brushes



CARTRIDGE STRIPS

- ✓ Suitable For PA97 And Most Other Strip Fed Tools
- ✓ Colour Coded For Strength Indication

Part Number	Colour	Strength	Quantity Per Box	Ship Wt.Kg Per 100	Price £ Per 100
V4LVS27Y	Yellow	Low/Medium	100	0.14	35.00
V6REDLVS27	Red	Medium/High	100	0.14	35.00
V7BLKLV27	Black	Extra High	100	0.14	40.00

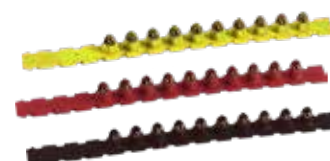



SHOT FIRED PINS

- ✔ For Fixing Into Steel And Concrete
- ✔ Suitable For Use In The PA97, DX450 and Other Cartridge Tools That Take Metal Washered Drive Pins
- ✔ 12mm Steel Washer For Guidance Within The Tool
- ✔ Increased Pull-Over Strength When Fixing Softer Materials

Part Number	Shank Diameter mm	Shank Length mm	Quantity Per Box	Ship Wt.Kg Per 100	Price £ Per 100
VMW16	3.7	16	100	0.25	8.11
VMW19	3.7	19	100	0.28	8.11
VMW22	3.7	22	100	0.31	7.82
VMW27	3.7	27	100	0.40	8.18
VMW32	3.7	32	100	0.46	8.48
VMW37	3.7	37	100	0.48	9.28
VMW42	3.7	42	100	0.54	10.16
VMW47	3.7	47	100	0.58	10.16
VMW52	3.7	52	100	0.66	11.76
VMW57	3.7	57	100	0.67	12.35
VMW62	3.7	62	100	0.68	12.57
VMW72	3.7	72	100	0.77	14.32
VMW82	3.7	82	100	0.99	17.83
VMW97	3.7	97	100	1.21	19.80



PLASTIC WASHERED PINS

- ✔ For Fixing Into Steel And Concrete
- ✔ Suitable For Use In 8mm Cartridge Tools
- ✔ 8mm Plastic Washer For Guidance Within The Tool

Part Number	Shank Diameter mm	Shank Length mm	Quantity Per Box	Ship Wt.Kg Per 100	Price £ Per 100
VPW16	3.8	16	100	0.17	7.16
VPW19	3.8	19	100	0.20	7.67
VPW22	3.8	22	100	0.22	7.23
VPW27	3.8	27	100	0.27	7.97
VPW32	3.8	32	100	0.32	8.62
VPW37	3.8	37	100	0.40	9.36
VPW42	3.8	42	100	0.42	10.09
VPW47	3.8	47	100	0.46	10.74
VPW52	3.8	52	100	0.52	11.55
VPW57	3.8	57	100	0.59	12.20
VPW62	3.8	62	100	0.66	12.86
VPW72	3.8	72	100	0.76	13.67



MAGAZINE PINS

- ✔ For Fixing Into Steel And Concrete
- ✔ Suitable For Use In 8mm Magazine Cartridge Tools
- ✔ Magazine Ensures Swift And Accurate Deployment

Part Number	Shank Diameter mm	Shank Length mm	Quantity Per Box	Ship Wt.Kg Per 100	Price £ Per 100
VSN19	3.8	19	100	0.25	8.84
VSN22	3.8	22	100	0.27	8.40
VSN27	3.8	27	100	0.32	9.14
VSN32	3.8	32	100	0.37	9.87
VSN37	3.8	37	100	0.45	10.53
VSN42	3.8	42	100	0.47	11.26
VSN47	3.8	47	100	0.51	11.92
VSN52	3.8	52	100	0.57	12.57
VSN57	3.8	57	100	0.64	13.37
VSN62	3.8	62	100	0.66	14.03
VSN72	3.8	72	100	0.81	14.69



DRILL BITS

A range of drill bits for various uses including drilling into harder materials, masonry, stainless steel and wood.



- ✓ Heavy Duty Drilling Options
- ✓ Sets Available

SDS+ DRILL BITS



- ✓ For Drilling Into Concrete, Natural Stone And Masonry
- ✓ High Strength Steel To Avoid Bending Or Snapping
- ✓ Tungsten Carbide Tip
- ✓ Heavy Duty Drilling
- ✓ Two Tungsten Carbide Cutting Edges

Part Number	Diameter mm	Working Length mm	Overall Length mm	Price £ Per Each
SD04110	4.0	50	110	1.42
SD05110	5.0	50	110	1.46
SD05160	5.0	100	160	1.62
SD55110	5.5	50	110	1.46
SD55160	5.5	100	160	1.62
SD55210	5.5	150	210	1.99
SD06110	6.0	50	110	1.46
SD06160	6.0	100	160	1.62
SD06200	6.0	150	200	1.99
SD06260	6.0	200	260	2.55
SD65110	6.5	50	110	1.54
SD65160	6.5	100	160	1.66
SD65210	6.5	150	210	2.07
SD65250	6.5	200	250	2.23
SD07110	7.0	50	110	1.62
SD07160	7.0	100	160	1.78
SD07210	7.0	150	210	2.19
SD08110	8.0	50	110	1.62
SD08160	8.0	100	160	1.74
SD08210	8.0	150	210	2.19
SD08260	8.0	200	260	2.55
SD08450	8.0	400	450	4.46
SD08600	8.0	550	600	5.76
SD10110	10.0	50	110	1.87
SD10160	10.0	100	160	1.99
SD10210	10.0	150	210	2.47
SD10260	10.0	200	260	2.76
SD10450	10.0	400	450	4.54
SD12160	12.0	100	160	2.39
SD12210	12.0	150	210	2.76
SD12260	12.0	200	260	3.04
SD12300	12.0	250	300	3.37
SD12450	12.0	400	450	4.87
SD12600	12.0	550	600	6.08

Part Number	Diameter mm	Working Length mm	Overall Length mm	Price £ Per Each
SD13160	13.0	100	160	2.84
SD13210	13.0	150	210	3.04
SD13260	13.0	200	260	3.24
SD14160	14.0	100	160	2.92
SD14210	14.0	150	210	3.33
SD14300	14.0	250	300	4.01
SD14450	14.0	400	450	5.76
SD14600	14.0	550	600	7.10
SD15160	15.0	100	160	3.53
SD15260	15.0	200	260	4.34
SD16210	16.0	150	210	3.93
SD16300	16.0	250	300	4.66
SD16450	16.0	400	450	6.69
SD16600	16.0	550	600	8.31
SD18200	18.0	150	200	5.27
SD18450	18.0	400	450	8.68
SD20200	20.0	150	200	6.00
SD20300	20.0	250	300	7.34
SD20450	20.0	400	450	10.02
SD22250	22.0	200	250	8.03
SD22450	22.0	400	450	11.36
SD24260	24.0	200	260	10.38
SD24450	24.0	400	450	14.40
SD25250	25.0	200	250	10.71
SD25450	25.0	400	450	14.72
SD26450	26.0	400	450	15.01
SD28450	28.0	400	450	15.82
SD30450	30.0	400	450	20.68



SDS+ HIGH PERFORMANCE DRILL BITS



- ✔ For Drilling Into Reinforced Concrete, Natural Stone And Masonry
- ✔ Force X Drill Bit
- ✔ Four Tungsten Carbide Cutting Edges
- ✔ Four Flute Design For More Efficient Dust Removal
- ✔ Long Lasting And Long Service Life
- ✔ Heavy Duty Drilling

Part Number	Diameter mm	Working Length mm	Overall Length mm	Price £ Per Each
SDHP05110	5.0	50	110	7.00
SDHP05160	5.0	100	160	7.60
SDHP55110	5.5	50	110	7.21
SDHP55160	5.5	100	160	7.92
SDHP06110	6.0	50	110	6.84
SDHP06160	6.0	100	160	7.55
SDHP06210	6.0	150	210	10.07
SDHP06260	6.0	200	260	13.61
SDHP65210	6.5	150	210	13.07
SDHP65260	6.5	200	260	18.20
SDHP07110	7.0	50	110	9.19
SDHP07160	7.0	100	160	9.98
SDHP08110	8.0	50	110	7.99
SDHP08160	8.0	100	160	8.73
SDHP08210	8.0	150	210	9.82
SDHP10110	10.0	50	110	8.57
SDHP10160	10.0	100	160	10.29
SDHP10210	10.0	150	210	11.30
SDHP10260	10.0	200	260	14.53
SDHP10450	10.0	400	450	32.46

Part Number	Diameter mm	Working Length mm	Overall Length mm	Price £ Per Each
SDHP12160	12.0	100	160	12.40
SDHP12210	12.0	150	210	13.70
SDHP12260	12.0	200	260	17.19
SDHP12450	12.0	400	450	35.23
SDHP14160	14.0	100	160	16.33
SDHP14210	14.0	150	210	22.39
SDHP14310	14.0	250	310	27.83
SDHP15160	15.0	100	160	23.09
SDHP16210	16.0	150	210	27.72
SDHP16310	16.0	250	310	38.82
SDHP16450	16.0	400	450	47.29
SDHP18250	18.0	200	250	41.95
SDHP18450	18.0	400	450	52.34
SDHP20250	20.0	200	250	46.10
SDHP20450	20.0	350	400	59.40
SDHP22250	22.0	200	250	53.30
SDHP22450	22.0	400	450	70.39

SDS MAX DRILL BITS

- ✔ For Drilling Into Concrete, Natural Stone And Masonry
- ✔ Cross Head Design
- ✔ Four Tungsten Carbide Cutting Edges
- ✔ Four Cutting Heads
- ✔ High Efficiency
- ✔ For SDS Max Heavy Duty Hammer Drilling



Part Number	Diameter mm	Working Length mm	Overall Length mm	Price £ Per Each
MAX12340	12.0	188	340	9.17
MAX12540	12.0	388	540	17.33
MAX13340	13.0	188	340	9.56
MAX13540	13.0	388	540	16.56
MAX14340	14.0	188	340	10.17
MAX14540	14.0	388	540	16.83
MAX14690	14.0	538	690	21.28
MAX15340	15.0	188	340	12.67
MAX15540	15.0	388	540	17.72
MAX16340	16.0	188	340	11.44
MAX16540	16.0	388	540	16.67
MAX16690	16.0	538	690	20.11
MAX18340	18.0	188	340	12.50
MAX18540	18.0	388	540	17.67
MAX20370	20.0	218	370	13.17
MAX20520	20.0	368	520	18.78
MAX20920	20.0	768	920	53.11
MAX22370	22.0	218	370	17.44
MAX22520	22.0	368	520	19.78
MAX22920	22.0	768	920	46.83

Part Number	Diameter mm	Working Length mm	Overall Length mm	Price £ Per Each
MAX24370	24.0	218	370	16.78
MAX24520	24.0	368	520	23.17
MAX25320	25.0	168	320	17.50
MAX25520	25.0	368	520	23.44
MAX25920	25.0	768	920	53.28
MAX26370	26.0	218	370	21.61
MAX26520	26.0	368	520	26.11
MAX28370	28.0	218	370	23.33
MAX28570	28.0	418	570	30.11
MAX30370	30.0	218	370	30.00
MAX30570	30.0	418	570	36.28
MAX32370	32.0	218	370	32.72
MAX32570	32.0	418	570	43.78
MAX32920	32.0	768	920	79.00
MAX35570	35.0	418	570	53.61
MAX38570	38.0	418	570	68.22
MAX40570	40.0	418	570	90.28

SDS+ DRILL BIT SETS

- For Drilling Into Concrete, Natural Stone And Masonry
- High Strength Steel To Avoid Bending Or Snapping
- Tungsten Carbide Tip Heavy Duty Drilling Two Tungsten Carbide Cutting Edges

Part Number	Description	Price £ Per Each
SDSET5	5 Piece Set - 5, 5.5, 6, 7 and 8mm	8.39
SDSET8	8 Piece Set - 5, 5.5, 6, 6.5, 7, 8, 10 and 12mm	15.01



SDSET5



SDSET8

MASONRY DRILL BITS

- For Drilling Into Brick, Block And Natural Stone Straight Shank For Percussion And Rotary Drilling
- Tungsten Carbide Tip For Greater Wear Size Stamped On Body



Part Number	Diameter mm	Working Length mm	Overall Length mm	Price £ Per Each
JMD04085	4.0	50	85	1.01
JMD45085	4.5	50	85	1.01
JMD05085	5.0	50	85	1.06
JMD05150	5.0	90	150	1.54
JMD55100	5.5	60	100	1.06
JMD55150	5.5	90	150	1.59
JMD06100	6.0	60	100	1.12
JMD06150	6.0	90	150	1.70
JMD06200	6.0	140	200	2.02
JMD65100	6.5	60	100	1.12
JMD65150	6.5	90	150	1.70
JMD65400	6.5	300	400	7.33
JMD07100	7.0	60	100	1.28
JMD07150	7.0	90	150	1.70
JMD08120	8.0	80	120	1.43
JMD08150	8.0	90	150	1.70
JMD08200	8.0	140	200	2.13
JMD08300	8.0	240	300	3.19
JMD08400	8.0	300	400	5.85
JMD10120	10.0	80	120	1.70
JMD10150	10.0	90	150	1.97
JMD10200	10.0	140	200	2.34
JMD10300	10.0	240	300	3.24
JMD10400	10.0	300	400	4.52
JMD10600	10.0	500	600	7.55
JMD101000	10.0	900	1000	16.74

Part Number	Diameter mm	Working Length mm	Overall Length mm	Price £ Per Each
JMD12150	12.0	90	150	2.60
JMD12200	12.0	140	200	2.71
JMD12300	12.0	240	300	3.61
JMD12400	12.0	300	400	6.32
JMD12600	12.0	500	600	7.97
JMD13400	13.0	300	400	6.64
JMD14150	14.0	90	150	3.83
JMD14200	14.0	140	200	5.05
JMD14400	14.0	300	400	6.32
JMD16150	16.0	90	150	4.25
JMD16200	16.0	140	200	5.21
JMD16300	16.0	240	300	5.90
JMD16400	16.0	300	400	6.96
JMD18200	18.0	140	200	6.16
JMD20160	20.0	100	160	7.23
JMD20200	20.0	140	200	7.71
JMD20300	20.0	240	300	8.61
JMD20400	20.0	300	400	9.94
JMD25160	25.0	100	160	8.61
JMD25200	25.0	140	200	10.42
JMD25300	25.0	240	300	12.22
JMD25400	25.0	300	400	14.93

MASONRY DRILL BIT SETS

- For Drilling Into Brick, Block And Natural Stone Straight Shank For Percussion And Rotary Drilling
- Tungsten Carbide Tip For Greater Wear Size Stamped On Body

Part Number	Description	Price £ Per Each
JMDSET5	5 Piece Set - 5, 5.5, 6, 7 and 8mm	6.25





HSS DRILL BITS

- ✔ For Drilling Into Alloyed Carbon And Plain Steel
- ✔ Ideal For Handheld Operations
- ✔ Twist Drill
- ✔ Hardwearing
- ✔ 135° Split Point Prevents Bit From Drifting And Enables Faster Penetration



Part Number	Diameter mm	Overall Length mm	Pack Quantity	Price £ Per Each	Part Number	Diameter mm	Overall Length mm	Pack Quantity	Price £ Per Each
HSS010	1.0	34	10	1.02	HSS062	6.2	101	10	2.25
HSS015	1.5	40	10	1.02	HSS064	6.4	101	10	2.25
HSS016	1.6	43	10	1.08	HSS065	6.5	101	10	2.25
HSS020	2.0	49	10	1.02	HSS066	6.6	101	10	2.38
HSS022	2.2	53	10	1.08	HSS068	6.8	109	10	2.63
HSS024	2.4	57	10	1.08	HSS070	7.0	109	10	2.63
HSS025	2.5	57	10	1.02	HSS072	7.2	109	10	2.77
HSS026	2.6	57	10	1.08	HSS075	7.5	109	10	3.02
HSS028	2.8	61	10	1.08	HSS078	7.8	117	10	3.27
HSS030	3.0	61	10	1.02	HSS080	8.0	117	10	3.27
HSS032	3.2	65	10	1.18	HSS082	8.2	117	10	3.52
HSS033	3.3	65	10	1.29	HSS085	8.5	117	10	3.65
HSS034	3.4	70	10	1.29	HSS088	8.8	125	10	3.95
HSS035	3.5	70	10	1.29	HSS090	9.0	125	10	3.95
HSS036	3.6	70	10	1.29	HSS094	9.4	125	10	4.31
HSS038	3.8	75	10	1.29	HSS095	9.5	125	10	4.31
HSS040	4.0	75	10	1.27	HSS098	9.8	133	10	4.67
HSS042	4.2	75	10	1.38	HSS100	10.0	133	5	4.67
HSS045	4.5	80	10	1.52	HSS102	10.2	133	5	4.67
HSS048	4.8	86	10	1.52	HSS105	10.5	133	5	5.22
HSS050	5.0	86	10	1.69	HSS110	11.0	142	5	6.08
HSS052	5.2	86	10	1.69	HSS115	11.5	142	5	6.42
HSS055	5.5	93	10	1.77	HSS120	12.0	151	5	7.31
HSS058	5.8	93	10	2.05	HSS125	12.5	151	5	7.69
HSS060	6.0	93	10	2.12	HSS130	13.0	151	5	7.95

HSS DRILL BITS (Imperial)

- ✔ For Drilling Into Alloyed Carbon And Plain Steel
- ✔ Ideal For Handheld Operations
- ✔ Twist Drill
- ✔ Hardwearing
- ✔ 135° Split Point Prevents Bit From Drifting And Enables Faster Penetration



Part Number	Diameter "	Overall Length mm	Pack Quantity	Price £ Per Each
HSSI00116	1/16	43	10	1.08
HSSI00332	3/32	57	10	1.08
HSSI00764	7/64	61	10	1.08
HSSI00108	1/8	65	10	1.18
HSSI00964	9/64	70	10	1.29
HSSI00532	5/32	75	10	1.27
HSSI001164	11/64	80	10	1.38
HSSI00316	3/16	80	10	1.52
HSSI001364	13/64	86	10	1.69
HSSI00732	7/32	93	10	2.05
HSSI00104	1/4	101	10	2.25
HSSI001764	17/64	109	10	2.63
HSSI00932	9/32	109	10	2.77
HSSI00516	5/16	117	10	3.27
HSSI001132	11/32	125	10	3.78
HSSI00308	3/8	133	10	4.31
HSSI001332	13/32	133	5	4.67
HSSI00716	7/16	142	5	6.08
HSSI00102	1/2	151	5	7.95



COBALT HSS DRILL BITS



- ✔ For Drilling Into High Alloyed Steels, Bearing Steels, Hot/Cold Rolled Steel, And Stainless Steel
- ✔ Long Lasting Performance ✔ Cobalt Alloy ✔ Ideal For Handheld Operations

Part Number	Diameter mm	Overall Length mm	Pack Quantity	Price £ Per Each
COB020	2.0	49	10	3.48
COB025	2.5	57	10	3.75
COB030	3.0	61	10	3.75
COB033	3.3	65	10	4.24
COB035	3.5	70	10	4.24
COB040	4.0	75	10	4.52
COB042	4.2	75	10	5.63
COB045	4.5	80	10	5.72
COB050	5.0	86	10	5.53
COB055	5.5	93	10	7.67
COB060	6.0	93	10	7.21
COB065	6.5	101	10	8.15
COB068	6.8	109	10	9.59
COB070	7.0	109	10	8.55
COB075	7.5	109	10	9.04

Part Number	Diameter mm	Overall Length mm	Pack Quantity	Price £ Per Each
COB080	8.0	117	10	11.30
COB085	8.5	117	10	11.08
COB090	9.0	125	10	14.49
COB095	9.5	125	10	16.93
COB100	10.0	133	5	16.41
COB105	10.5	133	5	23.72
COB110	11.0	142	5	26.27
COB115	11.5	142	5	33.30
COB120	12.0	151	5	37.82
COB125	12.5	151	5	45.16
COB130	13.0	151	1	48.55



HSS DRILL BITS (In Wallets)



- ✔ For Drilling Into Alloyed Carbon And Plain Steel ✔ Hardwearing ✔ Ideal For Handheld Operations
- ✔ 135° Split Point Prevents Bit From Drifting And Enables Faster Penetration ✔ Twist Drill

Part Number	Diameter mm	Overall Length mm	Pack Quantity	Price £ Per Each
HSSW010	1.0	34	3	3.92
HSSW015	1.5	40	3	3.92
HSSW020	2.0	49	3	3.92
HSSW025	2.5	57	3	3.92
HSSW030	3.0	61	3	3.92
HSSW035	3.5	70	2	3.53
HSSW040	4.0	75	2	3.53
HSSW045	4.5	80	2	3.99
HSSW050	5.0	86	2	4.34
HSSW055	5.5	93	2	4.49
HSSW060	6.0	93	2	5.17
HSSW065	6.5	101	1	3.27

Part Number	Diameter mm	Overall Length mm	Pack Quantity	Price £ Per Each
HSSW070	7.0	109	1	3.62
HSSW075	7.5	109	1	3.99
HSSW080	8.0	117	1	4.21
HSSW085	8.5	117	1	4.58
HSSW090	9.0	125	1	4.79
HSSW095	9.5	125	1	5.11
HSSW100	10.0	133	1	5.53
HSSW105	10.5	133	1	6.00
HSSW110	11.0	142	1	6.80
HSSW115	11.5	142	1	7.19
HSSW120	12.0	151	1	7.98
HSSW125	12.5	151	1	8.40
HSSW130	13.0	151	1	8.60



HSS REDUCED SHANK DRILL BITS



- ✔ For Drilling Into Alloyed Carbon And Plain Steel ✔ Hardwearing ✔ Ideal For Handheld Operations
- ✔ Allow For Drilling Larger Holes With Standard Drill Chucks
- ✔ Toughness And Precision Allow For Excellent Cutting Efficiency ✔ Twist Drill

Part Number	Diameter mm	Overall Length mm	Pack Quantity	Price £ Per Each
HSSRS14	14.0	160	5	12.49
HSSRS15	15.0	169	5	14.24
HSSRS16	16.0	178	3	16.88

Part Number	Diameter mm	Overall Length mm	Pack Quantity	Price £ Per Each
HSSRS17	17.0	184	3	23.90
HSSRS18	18.0	191	3	25.88
HSSRS20	20.0	205	3	38.33



HSS LONG SHANK DRILL BITS



- ✔ For Drilling Into Alloyed Carbon And Plain Steel
- ✔ Hardwearing
- ✔ Ideal For Handheld Operations
- ✔ Long Shank Enables Deeper Drilling Capability
- ✔ Toughness And Precision Allow For Excellent Cutting Efficiency
- ✔ Twist Drill

Part Number	Diameter mm	Overall Length mm	Pack Quantity	Price £ Per Each	Part Number	Diameter mm	Overall Length mm	Pack Quantity	Price £ Per Each
HSSLS030	3.0	100	1	2.79	HSSLS048	4.8	132	1	5.13
HSSLS032	3.2	100	1	3.00	HSSLS050	5.0	132	1	4.42
HSSLS035	3.5	112	1	3.17	HSSLS060	6.0	139	1	5.50
HSSLS040	4.0	119	1	3.50	HSSLS080	8.0	165	1	8.33

HSS DRILL BIT CASES



- ✔ HSS For Drilling Into Alloyed Carbon And Plain Steel
- ✔ Cobalt For Drilling Into High Alloyed Steels, Bearing Steels, Hot/Cold Rolled Steel, And Stainless Steel

Part Number	Description	Price £ Per Each
HSSTM06	6 Piece HSS Set - 2 - 8mm in Plastic Case	17.14
HSSTM10	10 Piece HSS Set - 1 - 10mm in Plastic Case	26.06
HSSKM19	19 Piece HSS Set - 1 - 10mm in Metal Case	39.00
HSSKM25	25 Piece HSS Set - 1 - 13mm in Metal Case	87.66
COBKM19	19 Piece HSS Cobalt Set - 1 - 10mm in Metal Case	97.08
COBKM25	25 Piece HSS Cobalt Set - 1 - 13mm in Metal Case	139.46



HSSTM06



HSSTM10



HSSKM19



HSSKM25



COBKM19



COBKM25

HSS COUNTERSINK DRILL BITS



- ✔ For Countersinking And Deburring Of Steels
- ✔ Three 90° Cutting Edges
- ✔ Used To Ensure Flat Headed Screws Sit Flush

Part Number	Description	Price £ Per Each
HSSCS0803	8.3mm (M4)	14.51
HSSCS1004	10.4mm (M5)	16.05
HSSCS1204	12.4mm (M6)	18.31
HSSCS1605	16.5mm (M8)	23.77
HSSCS2005	20.5mm (M10)	30.33
HSSCS2500	25.0mm (M12)	37.80



COBALT COUNTERSINK DRILL BITS

- For Countersinking And Deburring Of Steels
- Three 90° Cutting Edges
- Cobalt Alloy
- Particularly Suited For Use On Stainless Steel
- Used To Ensure Flat Headed Screws Sit Flush

Part Number	Diameter mm	Price £ Per Each
COBCS0803	8.3 (M4)	18.47
COBCS1004	10.4 (M5)	21.90
COBCS1204	12.4 (M6)	23.35
COBCS1605	16.5 (M8)	28.71
COBCS2005	20.5 (M10)	39.25
COBCS2500	25.0 (M12)	52.75
COBCS3100	31.0 (M16)	80.90



COBALT SLOTTED COUNTERSINK DRILL BITS

- For Countersinking And Deburring Of Steels
- Three 90° Cutting Edges
- Particularly Suited For Use On Stainless Steel
- Used To Ensure Flat Headed Screws Sit Flush
- Spoil Is Removed Through The Centre Of The Cutter To Prevent Damage To Tool

Part Number	Diameter	Price £ Per Each
COBSL0205	M2-M5 90°	18.78
COBSL0510	M5-M10 90°	25.61



MULTIDRILL TUNGSTEN CARBIDE UNIVERSAL DRILL BITS

- For Drilling Into Various Materials
- Universal And Versatile
- Four Step Profile For Fast Dust Extraction
- Carbide Tip
- Precise Drilling

Part Number	Diameter mm	Overall Length mm	Pack Quantity	Price £ Per Each
MUL040075	4.0	75	1	6.62
MUL050085	5.0	85	1	6.81
MUL050150	5.0	150	1	7.83
MUL055085	5.5	85	1	6.91
MUL055150	5.5	150	1	8.68
MUL060100	6.0	100	1	6.98
MUL060200	6.0	200	1	8.27
MUL065100	6.5	100	1	7.08
MUL065200	6.5	200	1	10.07
MUL070100	7.0	100	1	8.12
MUL070200	7.0	200	1	10.84
MUL080120	8.0	120	1	8.79
MUL080200	8.0	200	1	10.84
MUL100120	10.0	120	1	10.09
MUL100200	10.0	200	1	12.60
MUL120220	12.0	220	1	13.84
MUL140220	14.0	220	1	15.72
MULSET	4, 5, 6, 8, 10	-	1	29.75





AUGER DRILL BITS

- ✔ For Drilling Into Wood
- ✔ The Screw Tip Keeps The Drill Bit Accurate Throughout The Drilling
- ✔ Hexagon Shank For Improved Hold In The Drill Chuck
- ✔ A Spiral-Shaped Bit With A Threaded Tip At The Front And Two Chisels At Each Tip End

Part Number	Diameter mm	Overall Length mm	Pack Quantity	Price £ Per Each
AUG06230	6.0	230	1	1.78
AUG08230	8.0	230	1	1.87
AUG08460	8.0	460	1	3.16
AUG10230	10.0	230	1	2.19
AUG10460	10.0	460	1	3.61
AUG12230	12.0	230	1	2.68
AUG12460	12.0	460	1	4.42
AUG13230	13.0	230	1	2.80
AUG14230	14.0	230	1	3.00
AUG14460	14.0	460	1	5.39
AUG16230	16.0	230	1	3.57
AUG16460	16.0	460	1	6.61

Part Number	Diameter mm	Overall Length mm	Pack Quantity	Price £ Per Each
AUG18230	18.0	230	1	4.06
AUG18460	18.0	460	1	7.66
AUG19230	19.0	230	1	5.19
AUG20230	20.0	230	1	4.95
AUG20460	20.0	460	1	9.25
AUG22230	22.0	230	1	5.76
AUG25230	25.0	230	1	6.25
AUG25460	25.0	460	1	12.77
AUG28230	28.0	230	1	8.64
AUG30230	30.0	230	1	9.45
AUG32230	32.0	230	1	10.42



FLAT WOOD BITS

- ✔ For Drilling Larger Holes Into Wood, Rapidly
- ✔ Available Up To 38mm
- ✔ The Centre Spur Keeps The Drill Bit Accurate Throughout The Drilling

Part Number	Diameter mm	Overall Length mm	Price £ Per Each
FW06	6.0	158	1.54
FW08	8.0	158	1.54
FW10	10.0	158	1.54
FW12	12.0	158	1.83
FW13	13.0	158	1.83
FW14	14.0	158	2.08
FW16	16.0	158	2.08
FW18	18.0	158	2.08
FW19	19.0	158	2.08

Part Number	Diameter mm	Overall Length mm	Price £ Per Each
FW20	20.0	158	2.25
FW22	22.0	158	2.29
FW24	24.0	161	2.42
FW25	25.0	161	2.42
FW28	28.0	161	3.17
FW30	30.0	174	3.17
FW32	32.0	174	3.46
FW35	35.0	174	4.04
FW38	38.0	174	4.13



CENTRE SPUR WOOD BITS

- ✔ For Drilling Holes Into Softwood And Plywood
- ✔ Cuts A Clean-Sided Hole
- ✔ The Centre Spur Keeps The Drill Bit Accurate Throughout The Drilling

Part Number	Diameter mm	Overall Length mm	Price £ Per Each
TP03	3.0	60	1.00
TP04	4.0	70	1.00
TP05	5.0	85	1.04
TP06	6.0	90	1.13
TP07	7.0	105	1.29

Part Number	Diameter mm	Overall Length mm	Price £ Per Each
TP08	8.0	110	1.33
TP09	9.0	115	1.50
TP10	10.0	120	1.71
TP12	12.0	140	2.38



TORX DRIVER BITS

- ✔ Torx Drive Enables Higher Torque Transmission Than Other Drive Systems
- ✔ Torx Drive Helps Prevent Cam out

Part Number	Pack Quantity	Price £ Per Each
T25	1	0.33
T30	1	0.42
T40	1	0.50

Part Number	Pack Quantity	Price £ Per Each
T45	1	0.58
T50	1	0.67



Merchandising Solutions

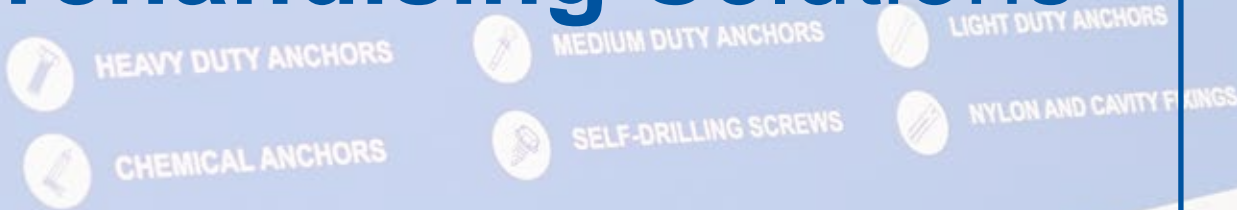

✔ Suitable for all JCP products

✔ Striking Livery

✔ Multiple Configurations

KEEP YOUR STORE VIBRANT WITH OUR MERCHANDISING SOLUTIONS

The JCP boxed, trade and retail bag range marry well, making for an eye-catching display. For more information on our new merchandising solutions, please contact your local sales office.

SUPPORTING YOU EVERY STEP OF THE WAY

Our Area Sales Managers have many years of experience in the field and are ready to work closely with our customers.

They can recommend and tailor a range of products that best suit your requirements.

Our Merchandising Representatives first assess the store area to be addressed, and from a selection of merchandisers determine which configuration works best, ensuring that products are available and engaging at the point of sale. They will oversee the building and positioning of the stands, along with loading them with stock.

Our after-sales support includes representatives making regular visits to replenish stock and ensure the display remains looking its best.

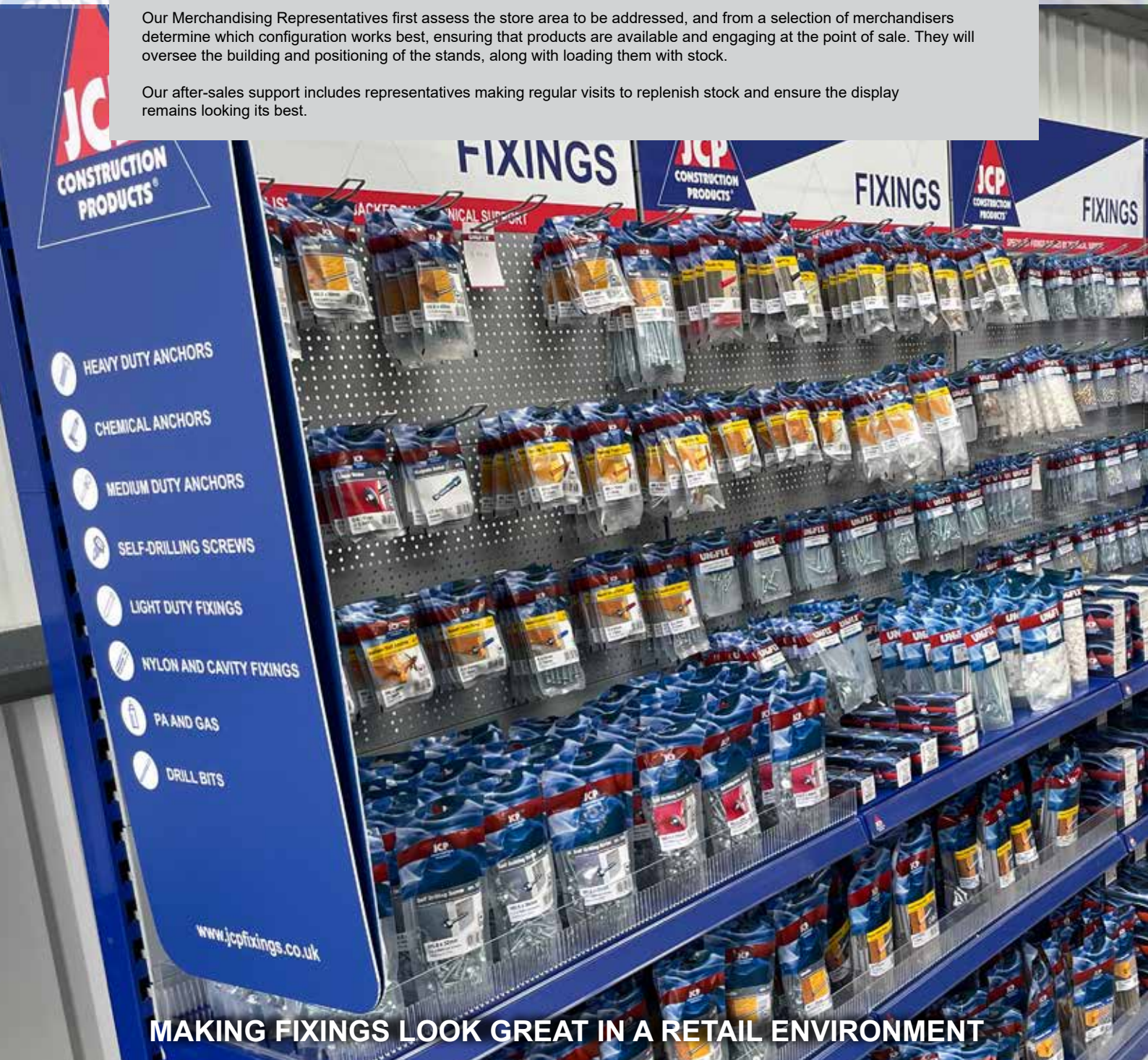

MAKING FIXINGS LOOK GREAT IN A RETAIL ENVIRONMENT



The Retail and Trade Bag Range

- ✔ Small Pack Sizes
- ✔ Striking Livery
- ✔ Best-Selling JCP Products



TRADE AND RETAIL PACKAGING

The JCP trade and retail packaging is full of information, making it user-friendly and enabling correct product selection and application. They also look great on our merchandising stands in a retail environment.

RETAIL

The retail range follows a similar offering to the trade bag range, conveniently packed in smaller quantities.



TRADE

The trade bag range covers popular products and sizes from the JCP range. The packaging is robust, re-sealable, drop-proof, water-resistant, easy to identify, and an ideal size to carry.



All products within the trade and retail range are categorised into one of four categories, with each product clearly colour coded on the front label.

 **HEAVY DUTY**

 **MEDIUM DUTY**

 **NYLON AND CAVITY**

 **SELF-DRILLING SCREWS**



The see-through bags allow for quick product identification whilst the image on the front clearly depicts its use. Clear instructions for installation can be found on the rear, along with extended technical details to aid in application.

JHANG/384

AWA Throughbolt
Clear Zinc Plated

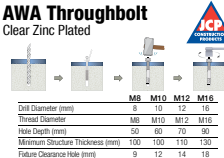

	M8	M10	M12	M16
Drill Diameter (mm)	8	10	12	16
Thread Diameter	M8	M10	M12	M16
Hole Depth (mm)	60	80	70	90
Minimum Structure Thickness (mm)	100	100	110	120
Fixture Clearance Hole (mm)	9	12	14	18
Tightening Torque (Nm)	20	35	60	120

CE 14 | JCP Construction Products | E-16, 188/1918 | 100% zinc plated | 100% zinc plated | 100% zinc plated | 100% zinc plated
www.jcpfixings.co.uk | Quality of origin: China



The labels feature a QR code which takes the customer to the product technical data sheet.

The label also shows base material icons which the product is recommended for.



Concrete

HEAVY DUTY RETAIL BAGS



ETA OPTION 7 THROUGH BOLTS BZP

✔ Concrete C20/25 To C50/60 ✔ Non-Cracked Concrete ✔ Minimum 5µm

Part Number	Size mm	Drill Diameter mm	Quantity Per Bag	Price £ Per Bag
JB8100	M8 x 65	8	6	3.73
JB8103	M8 x 100	8	6	4.03
JB8106	M10 x 75	10	4	3.73
JB8109	M10 x 90	10	4	4.03
JB8112	M10 x 120	10	4	4.88
JB8115	M12 x 100	12	4	4.88
JB8118	M16 x 125	16	2	5.74



BRIGHT ZINC PLATED



Concrete

For additional technical information see page 15



HEXAGON FLANGE HEAD ANKER BOLTS BZP

✔ Concrete C20/25 To C50/60 ✔ Non-Cracked Concrete ✔ Minimum 5µm

Part Number	Size mm	Drill Diameter mm	Quantity Per Bag	Price £ Per Bag
JB8300	6 x 50	6	6	3.03
JB8303	6 x 75	6	6	3.52
JB8306	6 x 100	6	4	3.52



BRIGHT ZINC PLATED



Concrete Solid Brick



Stone

For additional technical information see page 19



HEXAGON HEAD ANKER BOLTS BZP

✔ Concrete C20/25 To C50/60 ✔ Non-Cracked Concrete ✔ Minimum 5µm

Part Number	Size mm	Drill Diameter mm	Quantity Per Bag	Price £ Per Bag
JB8309	8 x 60	8	4	3.52
JB8312	8 x 75	8	4	4.03
JB8315	8 x 100	8	4	4.88
JB8317	8 x 150	8	4	5.40
JB8318	10 x 75	10	4	5.32
JB8321	10 x 100	10	4	6.18
JB8324	10 x 150	10	2	5.32



BRIGHT ZINC PLATED



Concrete Solid Brick



Stone

For additional technical information see page 20



COUNTERSUNK HEAD ANKER BOLTS BZP

✔ Concrete C20/25 To C50/60 ✔ Non-Cracked Concrete ✔ Minimum 5µm

Part Number	Size mm	Drill Diameter mm	Quantity Per Bag	Price £ Per Bag
JB8327	6 x 75	6	6	3.52
JB8330	6 x 100	6	4	3.73



BRIGHT ZINC PLATED



Concrete Solid Brick



Stone

For additional technical information see page 21



HOOK BOLTS BZP

- ✓ Fast And Secure Installation
- ✓ Expansion Free
- ✓ Minimum 5µm

Part Number	Size mm	Drill Diameter mm	Quantity Per Bag	Price £ Per Bag
JB8332	6 x 50 (90mm overall)	6	2	4.03

For additional technical information see page 24



BRIGHT ZINC PLATED



EYE BOLTS BZP

- ✓ Fast And Secure Installation
- ✓ Expansion Free
- ✓ Minimum 5µm

Part Number	Size mm	Drill Diameter mm	Quantity Per Bag	Price £ Per Bag
JB8333	6 x 50 (90mm overall)	6	2	4.03

For additional technical information see page 24



BRIGHT ZINC PLATED



HEXAGON FLANGE NUT SLEEVE ANCHORS ZYP

- ✓ Non-Cracked Concrete
- ✓ Supplied Pre-Assembled For Rapid Installation
- ✓ Minimum 5µm

Part Number	Size mm	Drill Diameter mm	Quantity Per Bag	Price £ Per Bag
JB8200	8 x 85	8	6	3.52
JB8203	10 x 75	10	4	3.31
JB8206	10 x 100	10	4	3.73
JB8209	12 x 75	12	4	4.03
JB8212	12 x 100	12	4	4.46

For additional technical information see page 52



ZINC AND YELLOW PLATED

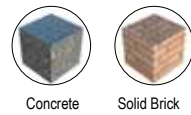

MEDIUM DUTY RETAIL BAGS



DROP IN ANCHORS ZYP

- ✓ Concrete C20/25 To C50/60
- ✓ Non-Cracked Concrete
- ✓ Minimum 5µm

Part Number	Size mm	Quantity Per Bag	Price £ Per Bag
JB8272	M8 x 30	5	2.84
JB8275	M10 x 40	5	3.65

For additional technical information see page 25



ZINC AND YELLOW PLATED





LOOSE BOLT SHIELD ANCHORS ZYP

- Non-Cracked Concrete C20/25 To C50/60
- Solid Concrete Blocks
- Solid Brickwork
- Minimum 5µm

Part Number	Size mm	Drill Diameter mm	Quantity Per Bag	Price £ Per Bag
JB8000	M6 x 10	12	10	5.74
JB8003	M6 x 25	12	10	6.18
JB8006	M8 x 10	14	6	5.32
JB8009	M8 x 25	14	6	5.74
JB8012	M8 x 40	14	6	6.18
JB8015	M10 x 10	16	4	5.74
JB8018	M10 x 25	16	4	6.18
JB8021	M10 x 50	16	4	6.61
JB8024	M10 x 75	16	4	7.47
JB8027	M12 x 10	20	2	4.88
JB8030	M12 x 25	20	2	5.32
JB8033	M12 x 60	20	2	6.18



ZINC AND YELLOW PLATED



Concrete Solid Brick

For additional technical information see page 55



PROJECTING BOLT SHIELD ANCHORS ZYP

- Non-Cracked Concrete C20/25 To C50/60
- Solid Concrete Blocks
- Solid Brickwork
- Minimum 5µm

Part Number	Size mm	Drill Diameter mm	Quantity Per Bag	Price £ Per Bag
JB8039	M6 x 10	12	6	4.03
JB8042	M8 x 15	14	6	5.74
JB8045	M8 x 80	14	4	5.32
JB8048	M10 x 30	16	4	6.61
JB8051	M10 x 70	16	4	7.47
JB8054	M12 x 50	20	2	5.74



ZINC AND YELLOW PLATED



Concrete Solid Brick

For additional technical information see page 56



EYE BOLT SHIELD ANCHORS ZYP

- Non-Cracked Concrete C20/25 To C50/60
- Solid Concrete Blocks
- Minimum 5µm

Part Number	Size	Drill Diameter mm	Quantity Per Bag	Price £ Per Bag
JB8060	M8	14	4	6.61



ZINC AND YELLOW PLATED



Concrete Solid Brick

For additional technical information see page 56



COUNTERSUNK HEAD CONCRETE SCREWS NO COVER CAPS ZYP

- Locking Ribs Under Head
- Undercutting Action
- Minimum 5µm

Part Number	Screw Length mm	Drill Diameter mm	Quantity Per Bag	Price £ Per Bag
JB8700	60	6	20	4.03
JB8703	80	6	20	5.32
JB8706	100	6	20	5.74
JB8709	120	6	10	4.46
JB8712	150	6	10	5.32



ZINC AND YELLOW PLATED



Concrete/Concrete Block Brick/Stone/Masonry

For additional technical information see page 58

NYLON AND CAVITY RETAIL BAGS



COUNTERSUNK HEAD NYLON HAMMER SCREWS ZYP

- ✔ For Use In Concrete And Masonry
- ✔ Ideal For Fast Fixing Repetitive Applications
- ✔ Countersunk Head Gives A Flush Finish

Part Number	Size mm	Drill Diameter mm	Quantity Per Bag	Price £ Per Bag
JB8427	6 x 40	6	20	2.87
JB8430	6 x 60	6	20	3.16
JB8433	8 x 80	8	10	3.31
JB8436	8 x 100	8	10	4.03
JB8439	8 x 120	8	10	4.46

For additional technical information see page 78



ZINC AND YELLOW PLATED

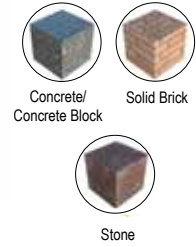

COUNTERSUNK NYLON FRAME FIXINGS ZYP

- ✔ For Use In Solid Base Materials
- ✔ Countersunk Head Gives A Flush Finish
- ✔ Strong Grip In Weaker Materials

Part Number	Size mm	Drill Diameter mm	Quantity Per Bag	Price £ Per Bag
JB8400	8 x 60	8	10	3.16
JB8403	8 x 80	8	10	3.52
JB8406	8 x 100	8	10	4.03
JB8409	8 x 120	8	10	4.46
JB8412	10 x 100	10	6	4.03
JB8415	10 x 120	10	6	4.46
JB8418	10 x 140	10	6	4.88
JB8421	10 x 160	10	6	5.32

For additional technical information see page 80



ZINC AND YELLOW PLATED

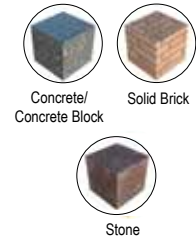

NYLON WALL PLUGS

- ✔ For Use In Solid Base Materials
- ✔ Suitable For Wood And Chipboard Screws
- ✔ 2 Way Expansion
- ✔ Screw Guidance
- ✔ Rimless

Part Number	Size mm	Drill Diameter mm	Quantity Per Bag	Price £ Per Bag
JB8509	6	6	40	3.03
JB8512	8	8	40	3.52
JB8515	10	10	20	3.73

For additional technical information see page 82

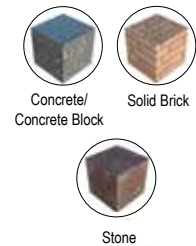

UNIVERSAL WALL PLUGS

- ✔ Use In Solid Or Hollow Base Materials

Part Number	Size mm	Drill Diameter mm	Quantity Per Bag	Price £ Per Bag
JB8521	6 x 40	6	40	3.52
JB8524	8 x 50	8	40	4.46

For additional technical information see page 82

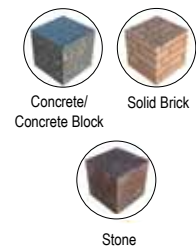



JCP PREMIUM PLASTIC PLUGS

- ✔ Supplied On A Sprue
- ✔ For Use In Concrete And Masonry Base Materials
- ✔ Suitable For Wood And Chipboard Screws

Part Number	Colour	Drill Diameter mm	Quantity Per Bag	Price £ Per Bag
JB8500	Red	6	50	2.74
JB8503	Brown	7	50	2.87

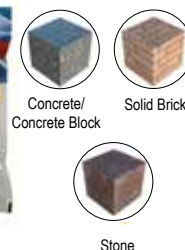

For additional technical information see page 84



J-PLUG PLASTERBOARD FIXINGS

- ✔ Comes Complete With Screw
- ✔ Self-Drilling
- ✔ Compatible with Hand or Power Screwdrivers

Part Number	Description	Quantity Per Bag	Price £ Per Bag
JB8615	Metal Plasterboard Fixing up to 15mm	6	2.59
JB8618	Metal Plasterboard Fixing up to 15mm	20	4.88
JB8621	Nylon Plasterboard Fixing up to 10mm	6	2.59
JB8624	Nylon Plasterboard Fixing up to 10mm	20	4.88

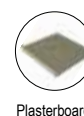

For additional technical information see page 85



ROSETT CAVITY FIXINGS

- ✔ Single And Double Skin Plasterboard Options Available
- ✔ Heavy-Duty
- ✔ 30% Glass Fibre Re-Enforced Thread
- ✔ Minimum 5µm

Part Number	Colour	Size	Drill Diameter mm	Quantity Per Bag	Price £ Per Bag
JB8600	Blue	M5 x 55mm	10	6	5.74
JB8603	Blue	M5 x 80mm	10	6	5.74
JB8606	Red	M5 x 65mm	10	6	5.74
JB8609	Red	M5 x 90mm	10	6	5.74

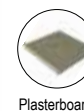

For additional technical information see page 85



PLASTERBOARD PLUGS

- ✔ Short Length Ideal For Dry Lined Walls
- ✔ Flange Head Prevents Push Through

Part Number	Drill Diameter mm	Quantity Per Bag	Price £ Per Bag
JB8663	7	20	3.73

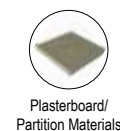

For additional technical information see page 88



HOLLOW WALL ANCHORS ZYP

- ✔ Provides A Strong, Permanent Anchorage To Plasterboard And Other Partition Materials
- ✔ Five Way Expansion ✔ All Metal Expanding Cavity Anchor ✔ Anti-Rotation Lugs
- ✔ Flange Head ✔ Complete With Pan Head Screws

Part Number	Description	Drill Diameter mm	Quantity Per Bag	Price £ Per Bag
JB8630	M4 x 45mm 8-13mm wall thickness	7	10	3.31
JB8633	M5 x 45mm 5-10mm wall thickness	9	10	4.03
JB8634	M5 x 60mm 5-13mm wall thickness	9	10	4.28
JB8636	M6 x 60mm 7-13mm wall thickness	10	10	4.88



ZINC AND YELLOW PLATED



Plasterboard/
Partition Materials



Hollow Block/
Clay Pots

For additional technical information see page 87



SPRING TOGGLES ZYP

- ✔ Can Be Used In Virtually Any Cavity Or Blind Fixing Situation From Hardboard To Hollow Steel Sections
- ✔ Various Sizes To Suit Different Wall Thicknesses ✔ Complete With Screws

Part Number	Size mm	Drill Diameter mm	Quantity Per Bag	Price £ Per Bag
JB8642	M5 x 50	14	6	3.52
JB8645	M5 x 75	14	6	4.03
JB8648	M6 x 75	18	6	4.46



ZINC AND YELLOW PLATED



Plasterboard/
Partition Materials



Hollow Block/
Clay Pots

For additional technical information see page 87



PLASTIC TOGGLES

- ✔ For Use In Hollow And Cavity Applications ✔ Quick And Easy To Apply
- ✔ Use With Standard Woodscrew ✔ Light Duty Applications

Part Number	Wall Thickness mm	Drill Diameter mm	Quantity Per Bag	Price £ Per Bag
JB8654	4-12	10	20	3.73
JB8657	15-19	10	20	4.03



Plasterboard/
Partition Materials



Hollow Block/
Clay Pots

For additional technical information see page 88

SELF-DRILLING SCREWS RETAIL BAGS

PLASTIC HEADED NAILS



- Available With Black Or White Heads To Match Soffit
- HDPE Impact Resistant Poly Head
- Ring Shanked
- UV Factor 5 Stabilised
- Maintenance Free
- Suitable For External Use And Marine Environments

A4-316
STAINLESS STEEL

Part Number	Colour	Size mm	Quantity Per Bag	Price £ Per Bag
JB8931	Black	2 x 30	25	2.96
JB8934	Black	2 x 40	25	3.19
JB8937	White	2 x 30	25	2.96
JB8940	White	2 x 40	25	3.19



For additional technical information see page 72

MASONRY NAILS



- Hardened And Tempered
- Manufactured From Austempered High Carbon Steel
- Versatile Nail Set By Hammer
- Oil Bathed
- Countersunk Head

Part Number	Size mm	Quantity Per Bag	Price £ Per Bag
LIGHT SHANK			
JB8900	2.5 x 25	30	2.30
JB8903	2.5 x 60	25	2.30
JB8906	2.5 x 40	20	2.30
MEDIUM SHANK			
JB8909	3.0 x 50	14	2.30
JB8912	3.0 x 60	12	2.30
JB8915	3.5 x 75	7	2.30



For additional technical information see page 73

BASIN FIXINGS



- Complete With Cover Caps

Part Number	Size mm	Drill Diameter mm	Quantity Per Bag	Price £ Per Bag
JB8945	10 x 140	14	2	4.03



For additional technical information see page 73

W.C FIXINGS



- Complete With Cover Caps

Part Number	Colour	Size mm	Drill Diameter mm	Quantity Per Bag	Price £ Per Bag
JB8948	White	6 x 70	8	2	3.16
JB8951	Chrome	6 x 70	8	2	3.16



For additional technical information see page 74



COUNTERSUNK HEAD WALL SCREWS

- Bright Zinc Plated Finish
- Fast And Secure Installation

Part Number	Size mm	Drill Diameter mm	Quantity Per Bag	Price £ Per Bag
JB8953	5 x 32	5	20	2.49
JB8956	5 x 38	5	20	2.80
JB8959	5 x 50	5	20	3.11

For additional technical information see page 75



STEEL



Concrete/
Concrete Block



Solid/Hollow
Brick



Wood/
Wall-Board



Stone



PAN HEAD WALL SCREWS

- Bright Zinc Plated Finish
- Fast And Secure Installation

Part Number	Size mm	Drill Diameter mm	Quantity Per Bag	Price £ Per Bag
JB8962	5 x 32	5	20	2.74
JB8965	5 x 38	5	20	3.08
JB8968	5 x 50	5	20	3.42

For additional technical information see page 75



STEEL



Concrete/
Concrete Block



Solid/Hollow
Brick



Wood/
Wall-Board



Stone



BIGTWIST NAILS

- Unique One Piece Stress Free Fixing
- No Need For Screws
- Grade 8.8 High Tensile Steel
- Rotates During Installation To Reduce The Risk Of Splitting Timber

Part Number	Size mm	Quantity Per Bag	Price £ Per Bag
JB8921	8 x 165	10	9.91
JB8924	8 x 195	10	11.07

For additional technical information see page 76



BRIGHT ZINC PLATED



Timber



Composite
Sections



LIGHT SECTION

METALFIX SELF-DRILLING SCREWS BZP

- For Fixing Steel To Steel
- Hexagon Head
- DIN 7504K
- C1022 Steel Case Hardened
- Minimum 8µm

Part Number	Size mm	Quantity Per Bag	Price £ Per Bag
JB8815	5.5 x 25	30	3.73
JB8818	5.5 x 38	30	4.03
JB8821	5.5 x 50	30	4.46

For additional technical information see page 59



BRIGHT ZINC PLATED



Light Steel
Sections



METALFIX SELF-DRILLING SCREWS WITH 16MM WASHER BZP

- For Fixing Steel To Steel
- Supplied With 16mm Washer
- EPDM Washer To Prevent Water Ingress
- For General Purpose Applications
- Hexagon Head
- DIN 7504K
- C1022 Steel Case Hardened
- Minimum 8µm

BRIGHT ZINC PLATED

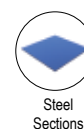

Part Number	Size mm	Quantity Per Bag	Price £ Per Bag
LIGHT SECTION			
JB8800	5.5 x 25	30	4.03
JB8803	5.5 x 32	30	4.46
JB8806	5.5 x 38	20	3.73
JB8809	5.5 x 50	20	4.46
HEAVY SECTION			
JB8827	5.5 x 32	20	3.73
JB8830	5.5 x 40	20	4.03
JB8833	5.5 x 50	20	4.46



For additional technical information see page 60



METALFIX LOOSE WASHERS BZP

- For Use With Self-Drilling Screws
- 1mm Steel With A 2mm Bonded EPDM Backing
- Creates A Watertight Seal

BRIGHT ZINC PLATED



Part Number	Size mm	Quantity Per Bag	Price £ Per Bag
JB8839	16	50	3.03
JB8842	19	50	3.52



For additional technical information see page 61



WOODFIX SELF-DRILLING SCREWS BZP

- For Fixing Timber To Steel
- Countersunk Head Gives Flush Finish
- DIN 7504P
- Wings Drill A Clearance Hole To Prevent The Timber Jacking
- C1022 Steel Case Hardened
- Minimum 8µm

BRIGHT ZINC PLATED

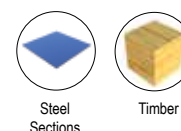

Part Number	Size mm	Quantity Per Bag	Price £ Per Bag
LIGHT SECTION			
JB8863	5.5 x 40	30	3.73
JB8866	5.5 x 50	30	4.03
JB8869	5.5 x 60	20	3.52
JB8872	5.5 x 80	20	4.46
JB8875	5.5 x 100	20	5.74
HEAVY SECTION			
JB8881	5.5 x 60	20	3.18
JB8884	5.5 x 85	20	4.21
JB8887	5.5 x 109	20	5.22



For additional technical information see page 62



METALFIX GASH POINT SELF-DRILLING SCREWS BZP

- ✔ For Fixing Steel To Timber
- ✔ Supplied With 16mm Washer
- ✔ EPDM Washer To Prevent Water Ingress
- ✔ Gash Point For Quick Penetration
- ✔ Hexagon Head
- ✔ Sharp Threads Ensure A Low Torque And Strong Fixing
- ✔ Minimum 8µm

Part Number	Size mm	Quantity Per Bag	Price £ Per Bag
JB8848	6.3 x 32	30	4.46
JB8851	6.3 x 45	30	5.32



BRIGHT ZINC PLATED

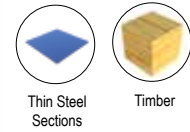

For additional technical information see page 62



METALFIX STITCHING SCREWS BZP

- ✔ For Joining Two Thin Sheets of Steel
- ✔ Supplied With 16mm Washer
- ✔ EPDM Washer To Prevent Water Ingress
- ✔ Hexagon Head
- ✔ DIN 7504K
- ✔ Larger Diameter To Give Better Grip In Steel
- ✔ Minimum 8µm

Part Number	Size mm	Quantity Per Bag	Price £ Per Bag
JB8857	6.3 x 25	30	4.03



BRIGHT ZINC PLATED



For additional technical information see page 63



WAFER HEAD SELF-DRILLING SCREWS BZP

- ✔ For Fixing Steel To Steel
- ✔ Low Profile Wafer Head For Larger Bearing Surface
- ✔ Sharp Point Designed To Penetrate Effectively
- ✔ Fine Thread Ensures Strong Connection

Part Number	Size mm	Quantity Per Bag	Price £ Per Bag
JB8893	4.2 x 13	30	2.45



BRIGHT ZINC PLATED



For additional technical information see page 65



METALFIX MAGNETIC SOCKETS

- ✔ Magnetic To Hold Screw In Place

Part Number	Size "	Quantity Per Bag	Price £ Per Bag
JB8899	5/16	1	4.03



For additional technical information see page 65

HEAVY DUTY TRADE BAGS



ETA OPTION 7 THROUGH BOLTS BZP

- Concrete C20/25 To C50/60
 Non-Cracked Concrete
 Minimum 5µm

Part Number	Size mm	Drill Diameter mm	Quantity Per Bag	Price £ Per Bag
JP3042	M8 x 50	8	40	13.89
JP3045	M10 x 100	10	18	13.89
JP3048	M12 x 100	12	12	13.89
JP3051	M12 x 140	12	10	13.89
JP3054	M12 x 180	12	8	13.89



BRIGHT ZINC PLATED



Concrete

For additional technical information see page 15



HEXAGON FLANGE HEAD ANKER BOLTS BZP

- Concrete C20/25 To C50/60
 Non-Cracked Concrete
 Minimum 5µm

Part Number	Size mm	Drill Diameter mm	Quantity Per Bag	Price £ Per Bag
JP3066	5 x 50	5	64	15.73
JP3069	6 x 50	6	30	15.73
JP3072	6 x 75	6	26	15.73
JP3075	6 x 100	6	20	15.73



BRIGHT ZINC PLATED



Concrete



Solid Brick



Stone

For additional technical information see page 19



HEXAGON HEAD ANKER BOLTS BZP

- Concrete C20/25 To C50/60
 Non-Cracked Concrete
 Minimum 5µm

Part Number	Size mm	Drill Diameter mm	Quantity Per Bag	Price £ Per Bag
JP3078	8 x 60	8	18	15.73
JP3081	8 x 75	8	14	15.73
JP3084	8 x 100	8	12	15.73
JP3087	8 x 150	8	8	15.73
JP3090	10 x 75	10	12	15.73
JP3093	10 x 100	10	8	15.73
JP3096	10 x 130	10	6	15.73
JP3099	10 x 150	10	6	15.73



BRIGHT ZINC PLATED



Concrete



Solid Brick



Stone

For additional technical information see page 20

MEDIUM DUTY TRADE BAGS



LOOSE BOLT SHIELD ANCHORS ZYP

- Non-Cracked Concrete C20/25 To C50/60
- Solid Concrete Blocks
- Solid Brickwork
- Minimum 5µm

Part Number	Size mm	Drill Diameter mm	Quantity Per Bag	Price £ Per Bag
JP3147	M6 x 10	12	48	17.59
JP3150	M6 x 25	12	46	17.59
JP3153	M8 x 10	14	26	17.59
JP3156	M8 x 25	14	26	17.59
JP3159	M8 x 40	14	22	17.59
JP3162	M10 x 10	16	22	17.59
JP3165	M10 x 25	16	116	17.59
JP3168	M10 x 50	16	14	17.59
JP3171	M10 x 75	16	14	17.59
JP3174	M12 x 60	20	10	17.59

For additional technical information see page 55



ZINC AND YELLOW PLATED



Concrete Solid Brick



PROJECTING BOLT SHIELD ANCHORS ZYP

- Non-Cracked Concrete C20/25 To C50/60
- Solid Concrete Blocks
- Solid Brickwork
- Minimum 5µm

Part Number	Size mm	Drill Diameter mm	Quantity Per Bag	Price £ Per Bag
JP3177	M10 x 30	16	15	17.59

For additional technical information see page 56



ZINC AND YELLOW PLATED



Concrete Solid Brick



COUNTERSUNK HEAD CONCRETE SCREWS-NO COVER CAPS

- Locking Ribs Under Head
- Undercutting Action
- Minimum 5µm

Part Number	Screw Length mm	Drill Diameter mm	Quantity Per Bag	Price £ Per Bag
JP3030	80	6	65	11.11
JP3033	100	6	55	11.11
JP3036	120	6	45	11.11
JP3039	150	6	30	11.11

For additional technical information see page 58



ZINC AND YELLOW PLATED



Concrete/Concrete Block Brick/Stone/Masonry

NYLON AND CAVITY TRADE BAGS



COUNTERSUNK HEAD NYLON HAMMER SCREWS ZYP

- For Use In Concrete And Masonry
- Ideal For Fast Fixing Repetitive Applications
- Countersunk Head Gives A Flush Finish

Part Number	Size mm	Drill Diameter mm	Quantity Per Bag	Price £ Per Bag
JP3018	6 x 40	6	135	7.83
JP3021	6 x 60	6	100	7.83
JP3024	8 x 80	8	50	7.83
JP3027	8 x 100	8	40	7.83

For additional technical information see page 78



ZINC AND YELLOW PLATED

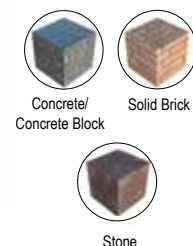

Concrete/Concrete Block Solid Brick

Stone



COUNTERSUNK NYLON FRAME FIXINGS ZYP

- ✓ For Use In Solid Base Materials
- ✓ Countersunk Head Gives A Flush Finish
- ✓ Strong Grip In Weaker Materials

Part Number	Size mm	Drill Diameter mm	Quantity Per Bag	Price £ Per Bag
JP3000	8 x 80	8	50	7.83
JP3003	8 x 100	8	40	7.83
JP3006	10 x 100	10	30	7.83
JP3009	10 x 120	10	25	7.83
JP3012	10 x 140	10	20	7.83
JP3015	10 x 160	10	15	7.83

For additional technical information see page 80



ZINC AND YELLOW PLATED

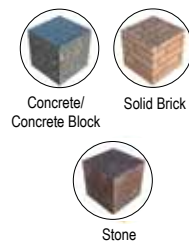

NYLON WALL PLUGS

- ✓ For Use In Solid Base Materials
- ✓ Suitable For Wood And Chipboard Screws
- ✓ 2 Way Expansion
- ✓ Screw Guidance
- ✓ Rimless

Part Number	Size mm	Drill Diameter mm	Quantity Per Bag	Price £ Per Bag
JP3180	6	6	200	4.60
JP3183	8	8	100	4.60
JP3186	10	10	70	4.60

For additional technical information see page 82

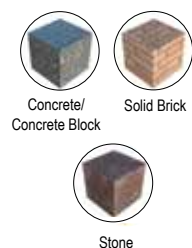

J-PLUG METAL PLASTERBOARD FIXINGS

- ✓ Comes Complete With Screw
- ✓ Self-Drilling
- ✓ Compatible With Hand Or Power Screwdrivers

Part Number	Size	Drill Diameter mm	Quantity Per Bag	Price £ Per Bag
JP3057	Up to 15mm	N/A	75	13.89

For additional technical information see page 85



ROSETT CAVITY FIXINGS

- ✓ Heavy Duty
- ✓ 30% Glass Fibre Re-Enforced Thread
- ✓ Minimum 5µm

Part Number	Size mm	Drill Diameter mm	Quantity Per Bag	Price £ Per Bag
JP3063	M5 x 55	10	10	13.89

For additional technical information see page 85

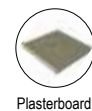

HOLLOW WALL ANCHORS ZYP

- ✓ Provides A Strong, Permanent Anchorage To Plasterboard And Other Partition Materials
- ✓ Five Way Expansion
- ✓ All Metal Expanding Cavity Anchor
- ✓ Anti-Rotation Lugs
- ✓ Flange Head
- ✓ Complete With Pan Head Screws

Part Number	Size mm	Drill Diameter mm	Quantity Per Bag	Price £ Per Bag
JP3060	M6 x 60 7-13mm Wall Thickness	10	40	13.89

For additional technical information see page 87



ZINC AND YELLOW PLATED

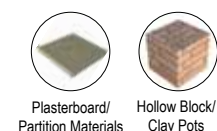

SELF-DRILLING SCREWS TRADE BAGS



COUNTERSUNK HEAD WALL SCREWS

- Bright Zinc Plated Finish
- Fast And Secure Installation

Part Number	Size mm	Drill Diameter mm	Quantity Per Bag	Price £ Per Bag
JP3192	5 x 32	5	100	10.26
JP3195	5 x 38	5	100	10.95
JP3198	5 x 50	5	100	11.63

For additional technical information see page 75



STEEL

Concrete/Concrete Block Solid/Hollow Brick
Wood/Wall-Board Stone



PAN HEAD WALL SCREWS

- Bright Zinc Plated Finish
- Fast And Secure Installation

Part Number	Size mm	Drill Diameter mm	Quantity Per Bag	Price £ Per Bag
JP3201	5 x 32	5	100	10.26
JP3204	5 x 38	5	100	10.95
JP3207	5 x 50	5	100	11.63

For additional technical information see page 75



STEEL

Concrete/Concrete Block Solid/Hollow Brick
Wood/Wall-Board Stone



METALFIX SELF-DRILLING SCREWS BZP

- For Fixing Steel To Steel
- Hexagon Head
- DIN 7504K
- C1022 Steel Case Hardened
- Minimum 8µm

Part Number	Size mm	Drill Diameter mm	Quantity Per Bag	Price £ Per Bag
LIGHT SECTION				
JP3108	5.5 x 25	N/A	200	15.73
JP3111	5.5 x 32	N/A	160	15.73
JP3114	5.5 x 38	N/A	150	15.73
JP3117	5.5 x 50	N/A	150	15.73
HEAVY SECTION				
JP3125	5.5 x 60	N/A	150	15.73
JP3127	5.5 x 70	N/A	150	15.73
JP3128	5.5 x 80	N/A	150	15.73

For additional technical information see page 59



BRIGHT ZINC PLATED

Light Steel Sections



METALFIX SELF-DRILLING SCREWS WITH 16MM WASHER BZP

- For Fixing Steel To Steel
- Supplied With 16mm Washer
- EPDM Washer To Prevent Water Ingress
- For General Purpose Applications
- Hexagon Head
- DIN 7504K
- C1022 Steel Case Hardened
- Minimum 8µm

Part Number	Size mm	Drill Diameter mm	Quantity Per Bag	Price £ Per Bag
LIGHT SECTION				
JP3120	5.5 x 25	N/A	140	15.73
JP3123	5.5 x 38	N/A	110	15.73
JP3126	5.5 x 50	N/A	85	15.73
HEAVY SECTION				
JP3129	5.5 x 40	N/A	100	15.73
JP3130	5.5 x 60	N/A	140	15.73
JP3131	5.5 x 70	N/A	140	15.73
JP3210	5.5 x 80	N/A	140	15.73
JP3133	5.5 x 100	N/A	100	15.73
JP3134	5.5 x 120	N/A	100	15.73

For additional technical information see page 60



BRIGHT ZINC PLATED

Steel Sections

LIGHT SECTION

HEAVY SECTION



WOODFIX SELF-DRILLING SCREWS BZP

- ✓ For Fixing Timber To Steel
- ✓ Countersunk Head Gives Flush Finish
- ✓ DIN 7504P
- ✓ Wings Drill A Clearance Hole To Prevent The Timber Jacking
- ✓ C1022 Steel Case Hardened
- ✓ Minimum 8µm

BRIGHT ZINC PLATED

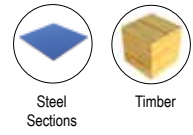

Part Number	Size mm	Drill Diameter mm	Quantity Per Bag	Price £ Per Bag
LIGHT SECTION				
JP3135	5.5 x 40	N/A	100	15.73
JP3138	5.5 x 50	N/A	100	15.73
JP3141	5.5 x 60	N/A	100	15.73
JP3144	5.5 x 80	N/A	100	15.73
JP3146	5.5 x 120	N/A	100	15.73
HEAVY SECTION				
JP3230	5.5 x 120	N/A	100	15.73



LIGHT SECTION

HEAVY SECTION

For additional technical information see page 62



METALFIX GASH POINT SELF-DRILLING SCREWS BZP

- ✓ For Fixing Steel To Timber
- ✓ Supplied With 16mm Washer
- ✓ EPDM Washer To Prevent Water Ingress
- ✓ Gash Point For Quick Penetration
- ✓ Hexagon Head
- ✓ Sharp Threads Ensure A Low Torque And Strong Fixing
- ✓ Minimum 8µm

BRIGHT ZINC PLATED



Part Number	Size mm	Drill Diameter	Quantity Per Bag	Price £ Per Bag
JP3102	6.3 x 32	N/A	120	15.73
JP3105	6.3 x 45	N/A	90	15.73



For additional technical information see page 62



METALFIX STITCHING SCREWS BZP

- ✓ For Joining Two Thin Sheets Of Steel
- ✓ Supplied With 16mm Washer
- ✓ EPDM Washer To Prevent Water Ingress
- ✓ Hexagon Head
- ✓ DIN 7504K
- ✓ Larger Diameter To Give Better Grip In Steel
- ✓ Minimum 8µm

BRIGHT ZINC PLATED



Part Number	Size mm	Drill Diameter mm	Quantity Per Bag	Price £ Per Bag
JP3132	6.3 x 25	N/A	120	15.73



For additional technical information see page 63

MERCHANDISING SOLUTIONS



Our Merchandising Representatives first assess the store area to be addressed and determine which configuration works best, ensuring that products are available and engaging at the point of sale. They will then oversee the building and positioning of the stands, along with loading them with stock. They will oversee all of the physical aspects of the project** whilst minimising disruption.

We offer an easy and efficient stock-cleansing service, to help customers seamlessly change over from other brands to ours.

Our after-sales support includes representatives making regular visits to replenish stock and ensure the display remains looking its best.

- ✔ **Striking Livery**
- ✔ **Multiple Configurations To Suit Your Space And Product Offering**
- ✔ **Professional Installation With Minimal Disruption**
- ✔ **Maximise Sales Across Market Leading Brands**

POS DISPLAYS

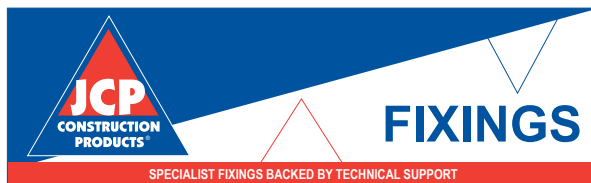

Article Number: OJ0004
Large Magnetic Header 987 x 300mm



Article Number: OJ0022
Small Magnetic Header/Footer 987 x 200mm



Article Number: OJ0008
Info Board 996 x 158mm



Article Number: OJ0027
Shelf Strip 998 x 38mm

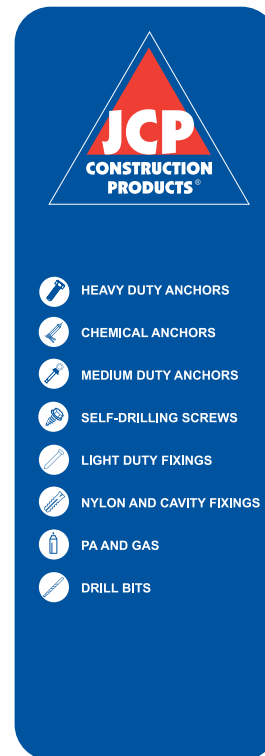

Article Number: OJ0012
Hanging Banner 987 x 200mm
(Includes Banner Arm)

** Excluding fixing the stand down.

STAND OPTIONS

ARTICLE NUMBER: OJ0019
SIZE: 2200 X 1000 X 470mm

Merchandising Stand With 5 Shelves

ARTICLE NUMBER: OJ0001
SIZE: 2200 X 1000 X 470mm

Merchandising Stand
With 50/50 Shelved and Perforated

ARTICLE NUMBER: OJ0040
SIZE: 2200 X 1000 X 470mm

Merchandising Stand Fully Perforated

ARTICLE NUMBER: OJ0020
SIZE: 1400 X 1000 X 470mm

Merchandising Stand With 3 Shelves

ARTICLE NUMBER: OJ0016
SIZE: 1400 X 1000 X 470mm

Merchandising Stand
With 50/50 Shelved and Perforated

ARTICLE NUMBER: OJ0021
SIZE: 1400 X 1000 X 470mm

Merchandising Stand Fully Perforated

A range of stand extras are also available.
See the merchandising stand brochure for
more information.



Download here



**Ask your Area Sales Manager for a printed copy of our
merchandising stands brochure or download a copy here**



CUSTOMER SUPPORT

A range of marketing support exclusively for our distributors.

As a stockist of JCP products we are here to support you. Our range of marketing support materials includes branded wall stickers, posters and banners suitable for internal and external displays.

For more information, speak to your Area Sales Manager.

WINDOW STICKERS

Help your store stand out with our branded window sticker.

BRAND	SIZE
JCP	150mm x 150mm



OUTDOOR BANNERS

Our branded banners are ideal for eye-catching indoor and outdoor advertising. PVC-free, they are fully recyclable and an environmentally friendly alternative to PVC banners.



BRAND	SIZE
JCP	2000mm x 600mm

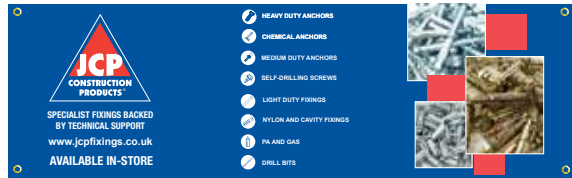

PRINTED AND DOWNLOADABLE POSTERS

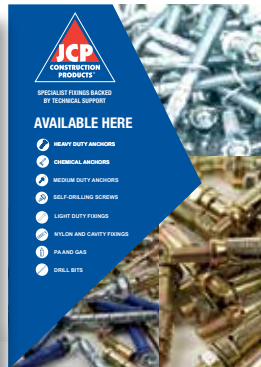
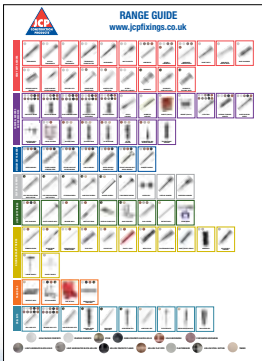

A range of branded posters showcasing features, benefits and range highlights.

Ideal for advertising in-store. Can be put into an existing frame or fixed to the wall.

All posters are available for instant download.

BRAND	SIZE
JCP	Printed A1 - Download A1 or A3
JCP Range Guide	Printed A1 - Download A1

Download here



JCP
CONSTRUCTION PRODUCTS®
SPECIALIST FIXINGS BACKED BY TECHNICAL SUPPORT
www.jcpfixings.co.uk
AVAILABLE IN-STORE

- HEAVY DUTY ANCHORS
- CHEMICAL ANCHORS
- MEDIUM DUTY ANCHORS
- SELF-DRILLING SCREWS
- LIGHT DUTY FIXINGS
- NYLON AND CAVITY FIXINGS
- PA AND GAS
- DRILL BITS





INDEX

Alloy Nail In Anchors.....	71	Hexagon Head Ankerbolts.....	20,22,105,115	Premium Nylon Wall Plugs.....	83
Alpen Drill Bits.....	94-99	Hexagon Head Nylon Frame Fixings.....	81	Projecting Bolt Shield Anchors.....	56,107,116
Angle Brackets.....	74	Hexagon Flange Nut Sleeve Anchors.....	52-53	Pure Epoxy Resin.....	38
Ankerbolts.....	19-23,105,115	High Speed Steel Drill Bits.....	96-98	Push Plugs.....	82
Ankerbolt Drop In Anchors.....	23	Hollow Wall Anchors.....	87,110,117	Road Fixing Kit.....	86
Ankerbolt Drop In Setting Tool.....	23	Hollow Wall Anchor Setting Tool.....	87	Rockite.....	41
Ankernuts.....	86	Hook Bolts.....	29,106	Rosett Cavity Fixings.....	85,109
Applicator Guns.....	51	Hook Bolt Shield Anchors.....	57	Round Perforated Fixing Band.....	77
Auger Drill Bits.....	100	Hook Bolt Sleeve Anchors.....	54	Sanitary Fixings.....	73-74,111
B1 Rated Expanding Foam.....	50	Hot Dipped Galvanised Throughbolts.....	16	Scaffold Eye Plugs.....	30
B2 Rated Expanding Foam.....	50	Hot Dipped Galvanised J-Fix Studs.....	43-44	Scaffold Retaining Eyes.....	30
B3 Rated Expanding Foam.....	49	HSS Cobalt High Speed Steel Drill Bits.....	97	Scaffold Ring Bolts.....	30
Basin Fixings.....	73,111	HSS Countersink Drill Bits.....	98	SDS+ Drill Bits.....	93-95
Bigtwist Nails.....	76,112	HSS Drill Bit Cases.....	98	SDS+ High Performance Drill Bits.....	94
Bi-Metal Masonry Screws.....	23	HSS Long Shank Drill Bits.....	98	SDS+ Drill Bit Sets.....	95
Blind Bolts.....	34-37	HSS Reduced Shank Drill Bits.....	97	SDS Max Drill Bits.....	94
Blow Out Pump.....	47	Imperial High Speed Steel Drill Bits.....	96	Self-Drilling Screws.....	59-70,112-113,118-119
Brad Nails and Gas.....	90	Injection Resin Internally Threaded Sockets.....	45	Setting Tool for Rod Hangers.....	70
Bright Zinc Plated Ankerbolts.....	19-21,105,115	Injection Tool Accessories.....	46	Shield Anchors.....	55-57,107,116
Bright Zinc Plated Drop In Anchors.....	25-26	Injection Tools.....	46	Shield Only Shield Anchors.....	56
Bright Zinc Plated Fibre Cement Screws.....	65-66	Internal Threaded Sockets.....	45-46	Shot Fired Pins.....	92
Bright Zinc Plated Heavy Duty Anchors.....	31-32	Intumescent and Acoustic Mastic.....	51	Sleeve Anchors.....	52-54
Bright Zinc Plated Internal Threaded Sockets.....	45	JCP Bulk Plastic Plugs.....	83	Socket Bolts.....	24
Bright Zinc Plated J-Fix Studs.....	42-43	JCP Premium Plastic Plugs.....	84,109	Spin In Capsules.....	41
Bright Zinc Plated Metalfix.....	59-64	JCP Standard Plastic Plugs.....	83	Spring Toggles.....	87-88,110
Bright Zinc Plated Throughbolts.....	15,105,115	J-Fix Epoxy Acrylate Resin.....	40	Stainless Steel Brad Nails.....	90
Bright Zinc Plated Woodfix.....	62,64,113	J-Fix Hammer In Glass Capsules.....	41	Stainless Steel Clipped Head Drivestack Gas Nails.....	89
Cartridge Strips.....	91	J-Fix Polyester Resin.....	40	Stainless Steel Heavy Duty Blind Bolts.....	36
Cartridge Tool.....	91	J-Fix Polyester Styrene Free Resin.....	40	Stainless Steel A2 Eye Bolt Sleeve Anchors.....	54
Ceiling Hangers.....	91	J-Fix Pure Epoxy Resin.....	38	Stainless Steel A2 Fixing Bands.....	77
Cementitious Grout.....	49	J-Fix Spin In Glass Capsules.....	41	Stainless Steel A2 Hammer Screws.....	79
Centre Spur Wood Bits.....	100	J-Fix Studs.....	43-44	Stainless Steel A2 Internal Threaded Sockets.....	45
Chemical Anchors and Accessories.....	38-51	J-Fix Ultra Bond 100 Epoxy Resin.....	38	Stainless Steel A2 J Fix Studs.....	44
Cleaning Brushes.....	47	J-Fix Vinylster Resin.....	39	Stainless Steel A2 Metalfix.....	66-68
Clipped Head Drivestack Gas Nails.....	89	J-Fix Vinylster Fast Cure Winter Grade Resin.....	39	Stainless Steel A2 Metalfix Stitching Screw.....	68
Cobalt Countersink Drill Bits.....	99	J-Plug Plasterboard Fixings.....	85,109,117	Stainless Steel A2 Sleeve Anchors.....	54
Cobalt Slotted Countersink Drill Bits.....	99	Kwixset.....	42	Stainless Steel A2 Stitching Bar.....	49
Coloured Cover Caps.....	68	Light Duty Fixings.....	71-77	Stainless Steel A2 Thin Wall Bolts.....	36
Concrete Screws.....	57-58,107,116	Lipped Drop In Anchors.....	26-27	Stainless Steel A2 Throughbolts.....	16
Concrete Screws Cover Caps.....	58	Loose Bolt Shield Anchors.....	55,107,116	Stainless Steel A2 Throughbolts.....	22-23
Countersunk Head Ankerbolts.....	21-22,105	Low Profile Metalfix Self-Drilling Screws.....	62	Stainless Steel A4 Blind Bolts.....	35-36
Countersunk Head Hammer Screws.....	78-79	Magazine Pins.....	94	Stainless Steel A4 Drop In Anchors.....	26
Countersunk Head Sleeve Anchors.....	53-54	Magnetic Drive Sockets.....	65,114	Stainless Steel A4 Heavy Duty Anchors.....	32-33
Countersunk Head Wall Screws.....	75,112,118	Masonry Drill Bits.....	95	Stainless Steel A4 Internal Threaded Sockets.....	46
Countersunk Heavy Duty Anchors.....	32-33	Masonry Drill Bit Sets.....	95	Stainless Steel A4 J-Fix Studs.....	44-45
Countersunk Nylon Frame Fixing.....	80-81,108,117	Masonry Nails.....	72-73,111	Stainless Steel A4 Lipped Drop In Anchors.....	26
Cover Caps.....	68	Masonry Nails with 8mm Washer.....	72	Stainless Steel A4 Nylon Frame Fixings.....	81
Crack Stitch Twist Starter Kit.....	48	Mechanical Galvanised Ankerbolts.....	21-22	Stainless Steel A4 Shield Anchors.....	56
Drill Bits.....	93-100	Mechanical Galvanised Fixing Bands.....	77	Stainless Steel A4 Sleeve Anchors.....	53
Drivestack Gas Nails.....	89	Medium Duty Anchors.....	52-58	Stainless Steel A4 Throughbolts.....	17
Drivestack Gas Only.....	90	Metal Expansion Plugs.....	84	Steel Nail In Anchors.....	71
Drop In Anchors.....	25-27,106	Metal Nail In Anchors.....	71	Stitching Bar.....	49
Drop In Anchor Setting Punches.....	28	Metalfix Self-Drilling Screws.....	59-68,112-113,118-119	Stop Drill Bits.....	28
Dual Threaded and Single Thread Socket Bolts.....	24	Metalfix Gash Point Self-Drilling Screws.....	62	Straight Perforated Fixing Band.....	77
Epoxy Acrylate Resin.....	40	Metalfix High Thread Self-Drilling Screws.....	63	Straight Shank Masonry Drill Bit Sets.....	95
ETA Approved Drop In Anchors.....	25-27	Metalfix Horizontal Hangers.....	69	Straight Shank Masonry Drill Bits.....	95
ETA Drop In Anchor Setting Punches.....	28	Metalfix Loose Washers.....	61,67	Stud and Nut Heavy Duty Anchors.....	32-33
ETA Approved Nylon Frame Fixings.....	80-81	Metalfix Magnetic Socket.....	65,114	Thin Wall Blind Bolts.....	36
ETA Dual Threaded Socket Bolts.....	24	Metalfix Stitching Screws.....	63,68,114	Throughbolts.....	14-17,105
ETA Option 1 Ankerbolts.....	20	Metalfix Vertical Hangers.....	69	Tool Kit PA97.....	91
ETA Option 1 Heavy Duty Anchors.....	31-33	Mixer Nozzles.....	46	TX Driver Bits.....	100
ETA Option 1 Throughbolts.....	15,17	Mixing Paddle.....	48	Universal Wall Plugs.....	82,108
ETA Option 7 Throughbolts.....	15,17,105,115	Multidrive Tungsten Carbide Universal Drill Bits.....	99	Vertical Flange Clips.....	74
Expanding Foam.....	49-50	Mushroom Head Nylon Hammer Screws.....	79	Vinylester Fast Cure Resin.....	39
Eye Bolt Shield Anchors.....	56,107	Nail In Anchors.....	71	Vinylester Resin.....	39
Eye Bolt Sleeve Anchors.....	54	Nail In Sockets.....	18	Wafer Head Self-Drilling Screws.....	65,114
Eye Bolts.....	24,106	Nylon and Cavity.....	78-88	Wall Screws.....	75,112,118
Eye and Hook Bolt Sleeve Anchors.....	54	Nylon Frame Fixings.....	80-81,108,117	W.C. Fixings.....	74,111
Fibre Cement Screws.....	65-66	Nylon Hammer Screws.....	78-79,116	Wirehangers.....	18
Fixing Bands.....	77	Nylon Sleeves.....	47	Wire Cleaning Brushes.....	47
Flange Head Hammer Screws.....	78	Nylon Toggles.....	88,110	Wire Mesh Sleeve.....	47
Flat Wood Bits.....	100	Nylon Wall Plugs.....	82,108,117	Woodfix Drive Bit.....	62
Forged Eye Bolts.....	29	PA97 Cartridge Tool Kit.....	91	Woodfix Self-Drilling Screws.....	62,64,113,119
Forged Hook Bolts.....	29	PA and Gas.....	89-92	Zinc and Yellow Plated Drop In Anchors.....	25-26,106
Galvanised Fixing Band.....	77	Pan Head Ankerbolts.....	21,23	Zinc and Yellow Plated Hollow Wall Anchors.....	87,117
Galvanised Angled Brads.....	90	Pan Head Wall Screws.....	75,112,118	Zinc and Yellow Plated J-Fix Studs.....	43
Gash Point Horizontal Hangers.....	70	Plain Ended J-Fix Studs.....	43-45	Zinc and Yellow Plated Nylon Frame Fixings.....	80,108,117
Gash Point Vertical Hangers.....	70	Plasterboard Fixings.....	85,117	Zinc and Yellow Plated Nylon Hammer Screws.....	78,108,116
General Purpose Metalfix Self-Drilling Screws.....	61	Plasterboard Plugs.....	88,109	Zinc and Yellow Plated Shield Anchors.....	55-56,107
Glass Capsules.....	41	Plastic Coated Fixing Bands.....	77	Zinc and Yellow Plated Sleeve Anchors.....	52-54,106
Hammer In Capsules.....	41	Plastic Headed Nails.....	72	Zinc and Yellow Plated Spring Toggles.....	87-88,110
Hammer Screws.....	78-79,108	Plastic Toggles.....	88,110	Zinc and Yellow Plated Throughbolts.....	14
Handi Pack Drivestack.....	90	Plastic Wall Plugs.....	82-84,108	Zinc Flake Blind Bolts.....	34-35
Heavy Duty Anchors.....	14-37	Plastic Washered Pins.....	92	Zinc Nickel Thin Wall Blind Bolts.....	36
Heavy Duty Blind Bolts.....	35-36	Pointing Gun.....	48		
Heavy Duty Expansion Anchors.....	31-33	Polyester Styrene Free Resin.....	40		
Hexagon Bolt Heavy Duty Anchors.....	31-32	Polyester Resin.....	40		
Hexagon Bolt Sleeve Anchors.....	53	Polyurethane Cleaner.....	51		
Hexagon Flange Head Ankerbolts.....	19,21-22,105,115	Pozi Pan Head Self-Drilling Screws.....	61		

TERMS AND CONDITIONS OF SALE

1. APPLICATION

Unless otherwise agreed in writing between the company and its customer, the following terms and conditions of sales shall apply to all sales of goods by the company to its customer.

2. PRICE VARIATION

Price applicable to the sales of goods by the company to the customer shall be the price ruling at the date of despatch. The company therefore reserves the right to amend prices quoted at the date of the placing of an order by the customer by notifying the customer in writing.

3. CARRIAGE

The Company reserves the right as part of this contract to impose such surcharge or carriage charge as shall be laid down by the company policy at any time. Such terms will be available for examination at the address of the company shown on the letterhead of its invoices and are deemed to be part of all contracts unless specifically agreed to the contrary in writing by the company. The company has sole choice of method of delivery and of carrier or carriers employed unless specifically agreed in writing to the contrary.

4. DESPATCH

Despatch dates are quoted without engagement although every endeavour will be made to adhere to the date or dates quoted. In no circumstances shall the company be liable for any loss arising from delay in despatch however caused. Time shall not be of the essence of the contract.

5. DAMAGE AND LOSS IN TRANSIT

5.1 The company accepts no liability for any damage to goods in transit unless notified to the company and the carrier concerned within twenty four hours after delivery.

5.2 In the case of non-delivery the company accepts no liability of any sort unless written notice of non-delivery is given to the company within seven days after the date of the advice of despatch of the goods.

5.3 Paragraphs one and two shall not apply to despatches to countries outside the United Kingdom of Great Britain, Northern Ireland and the Isle of Man. In respect of these countries the company accepts no liability for damage or loss in transit unless the company has contracted to supply the goods C.I.F. and the customer has adhered to the terms of the insurance policy.

5.4 The company's liability for damage in transit or non-delivery of goods duly notified to it in accordance with the above, shall in any event be limited solely to replacement of the goods within a reasonable time, whether non-delivery or damage is due to the company's negligence or otherwise.

6. CLAIMS

Subject to the provision of condition 5, all claims for goods alleged to be defective must be made in writing to the company within seven days after the date of delivery. When notification is so received the company may require return of the goods or for the goods to be made available for inspection by the company. Should the company be satisfied as to the defects then it retains the option to either replace the defective goods within a reasonable time or credit to the customer within the contract price. All defective goods so returned shall be the property of the company. Except as provided above, the company shall have no liability whatsoever arising out of any agreement to sell or sale of goods including claims for direct consequential or other loss, damage or expense, whether arising or alleged to arise under any warranty statement, conditional term expressed or implied, statutory or otherwise, or in negligence or alleged negligence on the part of the company or otherwise. In no circumstances shall the company be liable for loss or damage in excess of the contract sale price.

7. PASSING OF PROPERTY

Each of the following sub-clauses 7.1 to 7.6 are separate and severable and shall be enforceable accordingly:

7.1 Notwithstanding delivery, all goods supplied by us will remain our absolute property until you pay in full for them and for all other goods previously supplied by us;

7.2 You will store the goods in such a way that they are readily identifiable as our property, but you may, as trustees for us, sell them to a third party in the normal course of your business;

7.3 Upon any sale by you of the goods (either alone or with other items) all rights which you have against the buyer shall automatically vest in us;

7.4 We shall be entitled immediately after giving notice of our intention to repossess, to enter upon any premises with such transport as may be necessary and repossess any goods to which we have title under this Clause;

7.5 If you incorporate the goods we supply to you into other products with or without materials you already possess or which are supplied to you by third parties the property in such other product will pass to us and you shall store them without charge on our behalf as bailee;

7.6 You shall not be entitled to pledge or in any way charge by way of security any of the goods which remain our property but in the event you do so all moneys owing by you to us shall without prejudice to any other right or remedy available to us forthwith become due and payable.

8. PAYMENT

For the purpose of this Clause the due date shall mean the due date specified on the face of the invoice. Customers electing to pay by Direct Debit shall mean the 28th of the month following the month of the invoice. If you do not comply punctually with these terms of payment we reserve the right to charge you interest on any amount overdue at the rate of 1½% per month from the due date to the date of receipt of the monies outstanding, and without notice to suspend further deliveries until all arrears (including interest) have been paid and, at our option, to rescind any subsisting contract with you as to all or any parts of future deliveries but without prejudice to any rights already accrued to us under such contracts. Where a settlement discount is shown on the face of the invoice the customer may deduct this from his payment provided that payment in full less this discount is made by the due date.

9. ADDITIONAL DELIVERIES

Where the company has been obliged to make an additional delivery of the goods to the premises specified in the contract due to the failure of the customer to accept the delivery of the goods, the company reserves the right to make a charge for such additional delivery, unless the company failed to meet a specified time and date of delivery agreed in writing by the company and the customer. Any proposed delivery date specified on this invoice or on a sales order does not constitute such agreement in writing.

10. INTERPRETATION

Any agreement between the company and the purchaser shall be subject to and governed by the domestic law of England.

ABOUT US

Owlett-Jaton

The No. 1 choice for Quality, Service, and Value

Owlett-Jaton is the UK and Ireland's leading wholesale supplier of fasteners, fixings, and associated products to the distributor and merchant trade. Offering in excess of 30,000 product lines, we are also the largest stockholder in the industry.

Operating from a purpose-built warehouse in Stone, Staffordshire, our comprehensive stock line-up is backed by large stocks and efficient operations.

Our product range is the most comprehensive within our industry sector, and we understand that an important part of our offering is good stock availability, at all times. Our commitment to stock ensures products are available, competitively priced, for next-day delivery throughout most of the UK mainland.

FREE, NEXT-DAY DELIVERY WITH LOW MINIMUM ORDER LEVELS ACROSS THE MAJORITY OF THE UK MAINLAND.

We are the name behind some of the UK's leading fastener and fixing brands, including JCP, JRP, Thunderbolt, Unifix, and Vortex. With a comprehensive stock range in depth, volume, and continuity of supply, as well as a stock buying power that is unique to the market, we are recognised for offering the complete wholesale solution.

With over 30,000 product lines under one roof, customers can order multiple items, in small quantities, all from one supplier. For customers, this improves efficiency, provides cost savings, and enhances customer service levels.

Delivering continually high service levels, we have an enviable reputation for high-quality products and unrivalled customer service.

We take our service levels seriously and pride ourselves on our high levels of reliability, and lasting customer partnerships. With a network of sales offices and Area Sales Managers (ASM's), supported by our merchandising teams, customers have access to experienced staff, whilst online ordering provides visibility to pricing, stock availability, and more.

Our commitment to customer service and quality products is demonstrated by our ISO 9001:2015 Quality Management system. We are also dedicated to operating in an environmentally sustainable manner, and we are the first wholesaler in our industry to be awarded ISO 14001:2015 Environmental Management certification.

Owlett-Jaton is a trading division of Hexstone Ltd.

www.owlett-jaton.com

IMPLEMENTATION OF UKCA FOR CONSTRUCTION PRODUCTS

Owlett-Jaton

The Department for Levelling Up, Housing and Communities (DLUHC) is the Government Department responsible for Construction Products Regulation and the implementation of the new UKCA mark for construction products. In December 2022 they issued revised instructions on the implementation of UKCA for construction products.

Please note, the DLUHC requirements differ from advice on UKCA issued by the Department for Business, Energy and Industrial Strategy (BEIS) who are responsible for UKCA implementation on many other products. The DLUHC requirements need to be followed for construction products.

The new DLUHC information is:

- Products which have a valid CE marking will continue to be recognised as compliant until 30th June 2025.
- From 1st July 2025 products requiring certification in GB will need to have the UKCA mark, CE will no longer be recognised.
- Obtaining a UKCA mark will require the product to be tested in a UK facility and have the certification issued by a UK Conformity Assessment Body (CAB). Previous advice had been that the UK CAB's would be allowed to accept EU test results which had been prepared for CE certification.

With this change in the advice, Owlett-Jaton is working to ensure that products will continue to be available which meet all compliance requirements. It is our intention that all of our products currently CE marked will become dual marked with both CE and UKCA. This will allow our products to be compliant and sold in mainland GB, Northern Ireland and within the EU.

We have started a comprehensive programme of testing in the UK which should enable UKCA's to be issued for all of our products which are currently CE marked. We expect to complete this programme by mid 2024. As UKCA's become available they will be applied to products alongside the existing CE marking and will be phased in as new stock arrives. The UKCA and CE product requirements are identical, the introduction of UKCA will not result in any physical or product code changes.

Ian Doherty
Chief Executive
January 2024

The relevant information from DLUHC can be found at:

<https://www.gov.uk/guidance/construction-products-regulation-in-great-britain#construction-products-regulation-in-great-britain>



Technical Office

Teddington
tel **020 8943 1800**
jcp@owlett-jaton.com

Sales Office

Stone
tel **01785 819819**
info@owlett-jaton.com

Sales Office

Dartford
tel **01322 277733**
dartford.sales@owlett-jaton.com

Sales Office

Elland
tel **01422 370121**
elland.sales@owlett-jaton.com

Sales Office

Milton Keynes
tel **01908 201600**
milton.keynes@owlett-jaton.com

Sales Office

Swindon
tel **01793 527829**
swindon.sales@owlett-jaton.com



[/jcpconstructionproducts](#)



Head Office

Opal Way, Stone Business Park, Stone, Staffordshire ST15 0SW • Tel 01785 811300

Technical Helpline 020 8943 1800 • jcp@owlett-jaton.com